

RC
Carbon Composition (0.25 and 0.5 Watt)

RC
Ceramic Composition (0.5 Watt and above)

RF
Metal Film

Surface Mount

RW
Wirewound Power and Low Value

RP
Power Film

RM
High Voltage Thick Film

RC Series: carbon composition ($1/4$ & $1/2$ watt)
RC Series: ceramic composition (above $1/2$ watt)
RF Series: metal film
RW Series: wirewound
RP Series: power film
RM Series: high voltage thick film

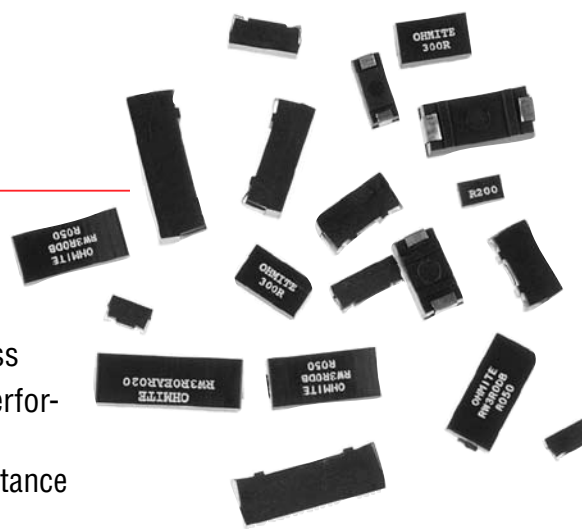
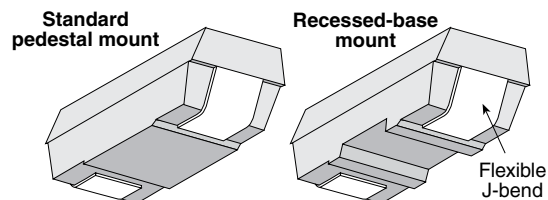

FEATURES

- Tolerance 1%, 5%, 10%, depending on construction
- Twelve wattage ratings
- Seven package sizes
- Two mounting designs to accommodate your soldering process
- Five power resistor technologies to optimize your operating performance:
 1. Carbon and Ceramic composition for surge and low inductance
 2. Metal film for high ohmic value and low T.C.
 3. Wire element for inrush current combined with low ohmic values. Resistance values as low as 0.005Ω
 4. Power film for high ohmic value and high wattage
 5. High Voltage thick film for high voltage applications
- Flexible J-bend terminations
- Working Temperature Range: -55°C to $+150^{\circ}\text{C}$

SERIES SPECIFICATIONS

| Part Number | Power (watts)* | Maximum voltage | 1% tol. | Resistance range 5% tol. | 10% tol. | Temp. Coefficient 0.1 Ω -1 Ω | 10 Ω + | Dielectric Withstanding | Tape Size 13" reels | Quantity per reel |
|-------------|----------------|-----------------|-------------------------|-----------------------------|--------------------|---|---------------|-------------------------|------------------------|-------------------|
| RC0S2CA | 0.25 | 250 | — | — | 2.2 Ω -5.6M | — | ± 400 | 1000V | 16mm | 1500 |
| RC0R5DB | 0.50 | 350 | — | — | 2.2 Ω -20M | — | ± 400 | 1000V | 24mm | 1000 |
| RW0S6BB | 0.6 | 50 | 0.010 Ω -1K | 0.005 Ω -1K | — | ± 90 | ± 50 | 1000V | 12mm | 2500 |
| RF0S8BA | 0.8 | 200 | 1 Ω -5M | — | — | — | ± 100 | 1000V | 12mm | 2000 |
| RW1S0BA | 1.0 | 50 | 0.005 Ω -1K | 0.005 Ω -1K | — | ± 90 | ± 50 | 1000V | 12mm | 2000 |
| RF1S0CA | 1.0 | 350 | 10 Ω -1M | 1 Ω -10M | — | — | ± 200 | 1000V | 16mm | 1500 |
| RC1R0EA | 1.0 | 500 | 3.3-100K (10% tol only) | | | — | -1300 | 1000V | 32mm | 750 |
| RP1S3CA | 1.25 | 350 | — | 1 Ω -1M | — | — | ± 250 | 1000V | 16mm | 1500 |
| RW1S5CA | 1.5 | 75 | 0.005 Ω -1.5K | 0.005 Ω -1.5K | — | ± 90 | ± 250 | 1000V | 16mm | 1500 |
| RP1S5CB | 1.5 | 350 | — | 1 Ω -1M | — | — | ± 250 | 1000V | 16mm | 1000 |
| RP1R5CB | — | — | — | — | — | — | — | — | — | — |
| RW2S0CB | 2.0 | 100 | 0.005 Ω -5K | 0.005 Ω -5K | — | ± 90 | ± 50 | 1000V | 16mm | 1000 |
| RW2R0CB | — | — | — | — | — | — | — | — | — | — |
| RP2S0DA | 2.0 | 500 | — | 1 Ω -1M | — | — | ± 250 | 1000V | 24mm | 1000 |
| RP2R0DA | — | — | — | — | — | — | — | — | — | — |
| RW2S0DA | 2.0 | 100 | 0.005 Ω -5K | 0.005 Ω -5K | — | ± 90 | ± 50 | 1000V | 24mm | 1000 |
| RW2R0DA | — | — | — | — | — | — | — | — | — | — |
| RP2R5DB | 2.5 | 500 | — | 1 Ω -1M | — | — | ± 250 | 1000V | 24mm | 1000 |
| RW3R0DB | 3.0 | 200 | 0.005 Ω -13K | 0.005 Ω -13K | — | ± 90 | ± 50 | 1000V | 24mm | 1000 |
| RP3R0EA | 3.0 | 750 | — | 1 Ω -1M | — | — | ± 250 | 1000V | 32mm | 750 |
| RW3R5EA | 3.5 | 350 | 0.005 Ω -25K | 0.005 Ω -25K | — | ± 90 | ± 50 | 1000V | 32mm | 750 |
| RM0R7EA | 0.75 | 2500 | 1K Ω -1000M | 1K Ω -1000M | — | — | ± 50 | 1000V | 32mm | 750 |

*25 $^{\circ}\text{C}$ ambient. E24 values standard; contact Ohmite for custom values.

(continued)

Surface Mount Power

PERFORMANCE DATA

| Construction | Temp. cycle (-55°C to 125°C, 1000 cycles) | Load Life (1000 hours at 25°C) | Immersion (260°C for 10 sec.) | Momentary Overload |
|------------------------------------|---|--------------------------------------|-------------------------------------|-----------------------------|
| RC Carbon/Ceramic Comp. | ±4.0%+.05Ω | ±10.0%+.05Ω | ±3.0%+.05Ω | 6.3x rated power for 5 sec. |
| RF Metal Film | ±0.5%+.05Ω | ±0.5%+.05Ω | ±0.1%+.05Ω | 2x rated power for 0.1 sec. |
| RW Wirewound | ±0.5%+.05Ω | ±3.0%+.05Ω | ±0.1%+.05Ω | 5x rated power for 5 sec. |
| RP Power Film | ±3.0%+.05Ω | ±5.0%+.05Ω | ±0.5%+.05Ω | 2x rated power for 0.1 sec. |
| RN Wirewound, Non-inductive | ±0.5%+.05Ω | ±3.0%+.05Ω | ±0.1%+.05Ω | 5x rated power for 5 sec. |

ALL models: **Leaching** (260°C Solder immersion, 60 sec.)..... No visible leaching
Thermal Shock (Units at -55°C, then rated power applied).. No mechanical damage
Flammability UL Material rating, UL94V0

Derating

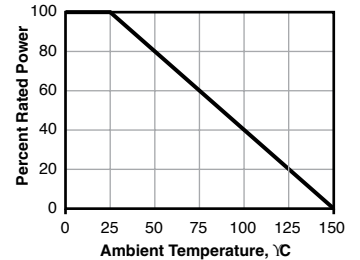

TCR

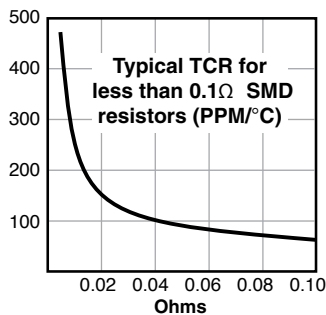

Recommended Solder Profile

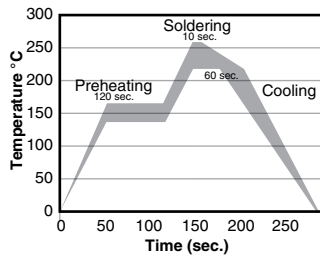

Preheating: 145°C ±15°, max. 120 sec.
Soldering: min. 220°C, max. 60 sec.
Max. Temp.: 260°C ±5°, 10 sec.

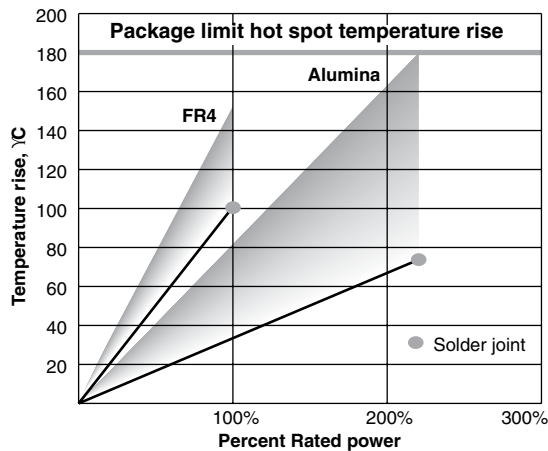

The temperature rise graph data was obtained by a selection of test substrate size and trace width for each resistor size to limit operating temperatures to safe values.

The operating temperature safe rises are either 100°C substrate temperature rise or 180°C package hot spot temperature rise at 25°C ambient.

FR4: 0.062 in. thick; 0.062 in. traces

Alumina: 0.040 in. thick; 0.010 in. traces

Molding material rated at 205°C continuous.

RC SERIES: BAKE PROCEDURE

RC SERIES ONLY

A. Heat Treatment

110°C ±10°C
15 hours

B. Frequency of heat treatment

1 time only

C. Cautions

Solderability: may be affected due to oxidization of lead wire

Resistance value: some units may not completely recover to original value.

Soldering heat: some treated product may have substantial resistance change during soldering operation. It is recommended that parts be tested to evaluate soldering heat effects.

Surface Mount Power

DIMENSIONS

(in./mm)

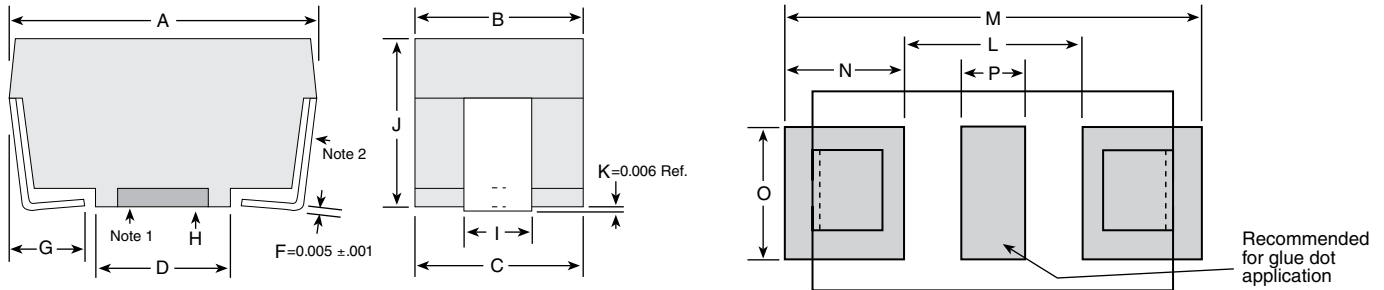

| Packages | Package Outline Dimensions | | | | | PC Board Land Pattern | | | | | | |
|-----------------|----------------------------|------------|-----------|-------------|--------------|-----------------------|------------|--------|-------|-------|-------|-------|
| | A | B | C | D | G | I | J | L | M | N | O | P |
| BA (in.) | 0.246±.020 | 0.136±.005 | 0.133 REF | 0.110±.010 | 0.047 ±0.020 | 0.054±.012 | 0.136±.005 | 0.150 | 0.346 | 0.098 | 0.126 | 0.050 |
| (mm) | 6.248±.508 | 3.454±.127 | 3.378 REF | 2.794±.254 | 1.194 ±0.508 | 1.372±.305 | 3.454±.127 | 3.81 | 8.79 | 2.49 | 3.20 | 1.27 |
| CA (in.) | 0.394±.020 | 0.159±.005 | 0.156 REF | 0.220±.010 | 0.062 Nom. | 0.078±.012 | 0.159±.005 | 0.256 | 0.524 | 0.134 | 0.126 | 0.060 |
| (mm) | 10.008±.508 | 4.039±.127 | 3.962 REF | 5.588±.254 | 1.575 Nom. | 1.981±.305 | 4.038±.127 | 6.50 | 13.31 | 3.40 | 3.20 | 1.52 |
| CB (in.) | 0.407±.020 | 0.226±.005 | 0.222 REF | 0.260±.010 | 0.062 Nom. | 0.084±.012 | 0.222±.005 | 0.276 | 0.537 | 0.131 | 0.126 | 0.093 |
| (mm) | 10.338±.508 | 5.74±.127 | 5.639 REF | 6.604±.254 | 1.575 Nom. | 2.134±.305 | 5.639±.127 | 7.01 | 13.64 | 3.33 | 3.20 | 2.36 |
| DA (in.) | 0.455±.020 | 0.240±.005 | 0.236 REF | 0.260±.010 | 0.062 Nom. | 0.143±.012 | 0.226±.005 | 0.317 | 0.585 | 0.134 | 0.155 | 0.093 |
| (mm) | 11.557±.508 | 6.096±.127 | 5.994 REF | 6.604±.254 | 1.575 Nom. | 3.632±.305 | 5.740±.127 | 8.05 | 14.86 | 3.40 | 3.94 | 2.36 |
| DB (in.) | 0.625±.020 | 0.273±.005 | 0.268 REF | 0.417±.010 | 0.062 Nom. | 0.143±.012 | 0.226±.005 | 0.474 | 0.742 | 0.134 | 0.155 | 0.093 |
| (mm) | 15.875±.508 | 6.934±.127 | 6.807 REF | 10.592±.254 | 1.575 Nom. | 3.632±.305 | 5.740±.127 | 12.040 | 18.85 | 3.40 | 3.94 | 2.36 |
| EA (in.) | 0.811±.020 | 0.273±.005 | 0.268 REF | 0.572±.010 | 0.093 Nom. | 0.143±.012 | 0.273±.005 | 0.611 | 1.000 | 0.195 | 0.155 | 0.093 |
| (mm) | 20.599±.508 | 6.934±.127 | 6.807 REF | 14.529±.254 | 2.362 Nom. | 3.632±.305 | 6.934±.127 | 15.52 | 25.4 | 4.95 | 3.94 | 2.36 |
| BB (in.) | 0.202±.010 | 0.10±.010 | 0.095 REF | 0.079±.010 | 0.050 Nom. | 0.065±.012 | 0.135±.005 | 0.078 | 0.328 | 0.125 | 0.126 | 0.026 |
| (mm) | 5.140±.508 | 2.54±.127 | 2.41 REF | 2.00±.254 | 1.280 Nom. | 1.640±.305 | 3.420±.127 | 1.98 | 8.33 | 3.18 | 3.20 | 0.66 |

Note 1: Packages BA and CA are only available with a pedestal base. Packages CB and DA are available in either pedestal or recessed base. Packages DB and EA are only available in a recessed base.

Note 2: Test point is .020 above PCB.

Note 3: Tape and reel dimensions per EIA 481 A except "EA" size which is 12 mm component pitch versus 16mm pitch.

Land pattern dimensions are for reference only

Reel Dimensions

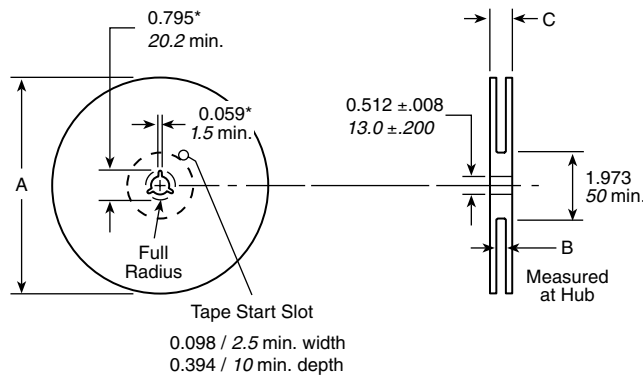

| Size | A nom. | B | C max. | Quantity |
|------|--------|---|------------------|---------------------------------|
| 12mm | 13" | 0.488" +0.078, -0.00 12.4mm +2.0, -0.0 | 0.724" 18.4mm | 2000 pcs. BA or 2500 pcs. BB |
| 16mm | 13" | 0.646" +0.078, -0.00 16.4mm +2.0, -0.0 | 0.882" 22.4mm | 1500 pcs. CA or 1000 pcs. CB |
| 24mm | 13" | 0.961" +0.078, -0.00 24.4mm +2.0, -0.0 | 1.196" 30.4mm | 1000 pcs. DA or DB |
| 32mm | 13" | 1.276" +0.078, -0.00 32.4mm +2.0, -0.0 | 1.52" 38.4mm | 750 pcs. EA |

All reels are compatible with major pick-and-place machines and made in accordance with EIA 481 A (except EA size, which is 12mm component pitch versus 16mm pitch).

(continued)

Surface Mount Power

ORDERING INFORMATION

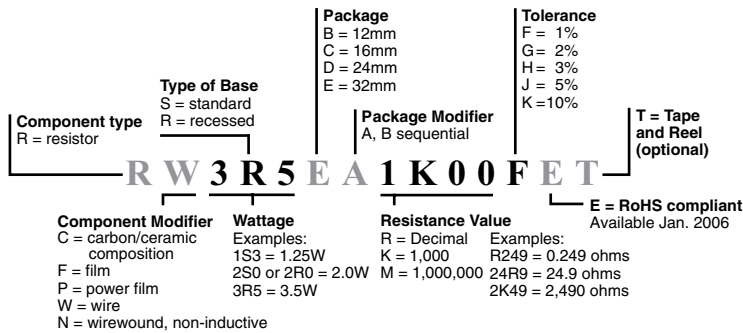

(For example, the part number shown is a wire-wound resistor, 3.5 watt, recessed base, 32mm tape size, first case size [A], 1000 ohms 1% tolerance.)

Standard Part Numbers for Surface Mount Power Resistors

| | | Wirewound | | | | | | | | | |
|----------------------------|---|-----------|---------|---------|---------|---------|---------|---------|---------|---------|--|
| Package style | BA | CA | CB | CB | DA | DA | DB | EA | BB | EA | |
| Base: standard or recessed | S | S | S | R | S | R | R | R | S | R | |
| Wattage | 1.0 | 1.5 | 2.0 | 2.0 | 2.0 | 2.0 | 3.0 | 3.5 | 0.6 | 1.0 | |
| Ohmic value | Part No. | | | | | | | | | | |
| Prefix | RW1S0BA | RW1S5CA | RW2S0CB | RW2R0CB | RW2S0DA | RW2R0DA | RW3R0DB | RW3R5EA | RW0S6BB | RC1R0EA | |
| Suffix | Tolerance suffix: F = 1% J = 5% K = 10% | | | | | | | | | | |
| 0.005 | —R005— | J | J | | F/J | | | | | | |
| 0.010 | —R010— | F/J | J | J | F | J | J | J | F | | |
| 0.015 | —R015— | F/J | J | | | | | | F | | |
| 0.020 | —R020— | J | J | J | F | J | | J | F | | |
| 0.025 | —R025— | J | | | | | | | | | |
| 0.027 | —R027— | J | | | | | | | | | |
| 0.030 | —R030— | F | J | J | | | | J | F | | |
| 0.033 | —R033— | J | | | | | | | | | |
| 0.036 | —R036— | J | | | | | | | | | |
| 0.050 | —R050— | F/J | J | J | J | F | J | J | F | | |
| 0.056 | —R056— | J | | | | | | | | | |
| 0.075 | —R075— | J | | | | | | | F | | |
| 0.080 | —R080— | J | | | | | | J | | | |
| 0.100 | —R100— | F/J | J | J | J | F | J | J | F | | |
| 0.150 | —R150— | J | J | J | J | | | | | | |
| 0.200 | —R200— | J | J | | | | | J | | | |
| 0.220 | —R220— | J | J | | | | | | | | |
| 0.240 | —R240— | J | J | | | | | | F | | |
| 0.300 | —R300— | J | | J | | | | | | | |
| 0.330 | —R330— | | | J | | | | | | | |
| 0.400 | —R040— | J | | | | | | | | | |
| 0.400 | —R400— | | | J | | | | | | | |
| 0.470 | —R470— | J | J | | | J | | | F | | |
| 0.500 | —R500— | J | J | | J | | | J | | | |
| 0.750 | —R750— | J | | | | | | | F | | |
| 1.00 | —1R00— | F/J | J | J | | J | J | | F | | |
| 2.00 | —2R00— | | | | | | | | F | | |

| | | Wirewound | | | | | | | | | |
|----------------------------|---|-----------|---------|---------|---------|---------|---------|---------|---------|---------|--|
| Package style | BA | CA | CB | CB | DA | DA | DB | EA | BB | EA | |
| Base: standard or recessed | S | S | S | R | S | R | R | R | S | R | |
| Wattage | 1.0 | 1.5 | 2.0 | 2.0 | 2.0 | 2.0 | 3.0 | 3.5 | 0.6 | 1.0 | |
| Ohmic value | Part No. | | | | | | | | | | |
| Prefix | RW1S0BA | RW1S5CA | RW2S0CB | RW2R0CB | RW2S0DA | RW2R0DA | RW3R0DB | RW3R5EA | RW0S6BB | RC1R0EA | |
| Suffix | Tolerance suffix: F = 1% J = 5% K = 10% | | | | | | | | | | |
| 3.30 | —3R30— | | | | | | | | | K | |
| 4.70 | —4R70— | | | | | | | | | K | |
| 5.00 | —5R00— | | | | | | | | F | | |
| 5.60 | —5R60— | J | | | | | | | | | |
| 6.80 | —6R80— | | | | | | | | | K | |
| 7.50 | —7R50— | | | | | | J | F | | K | |
| 10.00 | —10R0— | J | J | | | J | | F | F | K | |
| 15.00 | —15R0— | J | J | | | | | F | F | K | |
| 20.00 | —20R0— | | J | | | | | | | | |
| 22.00 | —22R0— | | | | | | | | | K | |
| 24.90 | —24R9— | | | | | | | F | F | K | |
| 33.00 | —33R0— | | | | | | | F | F | K | |
| 36.00 | —36R0— | | | | | | | F | F | K | |
| 47.00 | —47R0— | J | | | | | J | F | F | K | |
| 50.00 | —50R0— | | | | | | | | | | |
| 51.00 | —51R0— | J | | | | | | J | | | |
| 68.00 | —68R0— | | | | | | | | | K | |
| 82.00 | —82R0— | | | J | | | | | | | |
| 100.00 | —100R— | | J | | | | | F | F | K | |
| 120.00 | —120R— | | J | | | | | | | | |
| 180.00 | —180R— | J | | | | | | | | | |
| 300.00 | —300R— | J | | | | | | | | | |
| 470.00 | —470R— | | | | J | | | | | | |
| 1K | —1K00— | | | | | | J | | | K | |
| 4.7K | —4K70— | | | J | | | | J | | | |
| 5K | —5K00— | | | | | | | J | | | |