

250 Series



'Thin' Stackohm® Vitreous Enamel Power



When limited space is a consideration, choose Ohmite's "thin" stackable 250 Type resistors. These oval-shaped ceramic-core resistors feature a low profile to permit installation in spaces with height restrictions. They are also equipped with integral mounting brackets so they can be fastened to a chassis and stacked in locations with limited surface area.

When properly fastened, the mounting brackets add a heat sinking benefit resulting in a smaller size per watt. Durable 250 Type resistors are fully welded and coated with lead free vitreous enamel.

FEATURES

- Small size-to-power ratio.
- Stackable
- Integral mounting bracket conducts heat to mounting surface.
- Low profile for use in equipment where space is limited.
- All-welded construction.
- RoHS compliant product available. Add "E" suffix to part number to specify.

SERIES SPECIFICATIONS

Series	Wattage	Ohms	Max. Voltage*
F10	10	1.0-15K	187
F20	20	1.0-50K	815
F30	30	1.0-10K	281
F40	40	1.0-25K	655
F55	55	1.0-30K	1405

Adjustable versions and other sizes available; Consult Ohmite Also available in low cost Centohm or Silicone coating; Consult Ohmite.

* Maximum Voltage is based on Ohm's Law $[V=\sqrt{P \cdot R}]$ as limited by the resistance value of specified product

CHARACTERISTICS

Coating	Lead free vitreous enamel
Core	Ceramic
Terminals	Tinned lug with hole. RoHS solder composition is 96% Sn, 3.5% Ag, 0.5% Cu
Derating	Linearly from 100% @ +25°C to 0% @ +350°C
Tolerance	±5% (J)
Power rating	Based on mounting a single resistor on a metal surface measuring 10" (254mm) square by 0.04" (1.016mm) thick. Reduce rating by 15% when mounting on non-metallic surface
Overload	10x rated wattage for 5 seconds if max. voltage is not exceeded
Temperature coefficient	1 to 20Ω: ±400 ppm/°C Over 20Ω: ±260 ppm/°C
Dielectric with-standing voltage	500 VAC: 10 and 20 watt rating. 1000 VAC: 30, 40 and 55 watt rating (measured from lug to mounting bracket)
Max. amps	To calculate, use the formula $\sqrt{P/R}$

250 Series

'Thin' Stackohm® Vitreous Enamel Power

DIMENSIONS

(in. / mm)

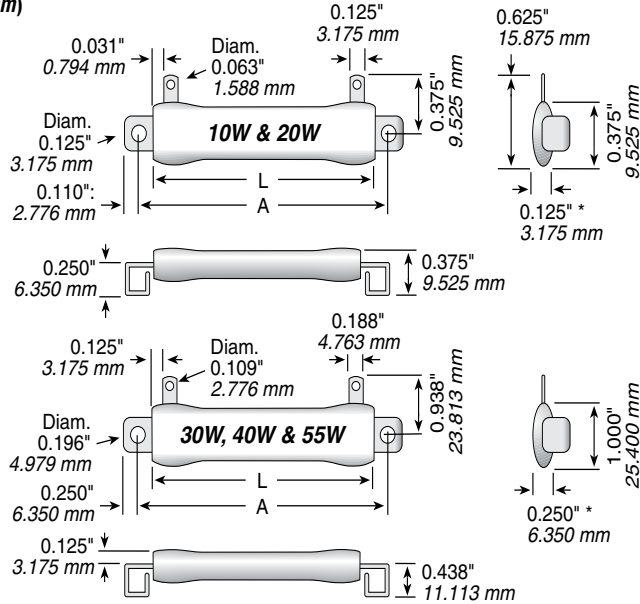

Series	Wattage	Length L	Length A
F10	10	0.750 / 19.050	1.000 / 25.400
F20	20	2.000 / 50.800	2.313 / 58.750
F30	30	1.250 / 31.750	2.000 / 50.800
F40	40	2.000 / 50.800	2.750 / 69.850
F55	55	3.500 / 88.900	4.250 / 107.950

*Reference dimension only; varies according to resistance value.

Note: When resistors are stacked, use washers or spacers as required to insure clearance and improve power dissipation.

MOUNTING

In addition to the standard box bracket, stud type brackets are available for stacking the standard size resistors. Stud type brackets are available in two heights: standard (SS, 0.437"/11.113mm) and high (SSH, 0.531"/13.494mm). The SSH stud is recommended when stacking the adjustable Type 260, as it assures clearance for the adjustable lugs to pass each other. Spacer washer No. 6027 (O.D. 0.219"/5.566mm, I.D. 0.125"/3.175mm, thickness 0.094"/2.381mm) is recommended for use with the miniature adjustable and fixed resistors to provide clearance, as explained above, or increased wattage. See chart.

Derating for stacked mounting

Stacked resistors should be derated to prevent excessive temperatures due to proximity. Approximate ratings are given in the table.

No. of Resistors	Percent of Single Unit Rating		
	Std. or Inter.	Miniature	Miniature with 0.094" (2.381 mm) Spacer Washer
2	70	70	75
3	60	60	69
4	50	50	60

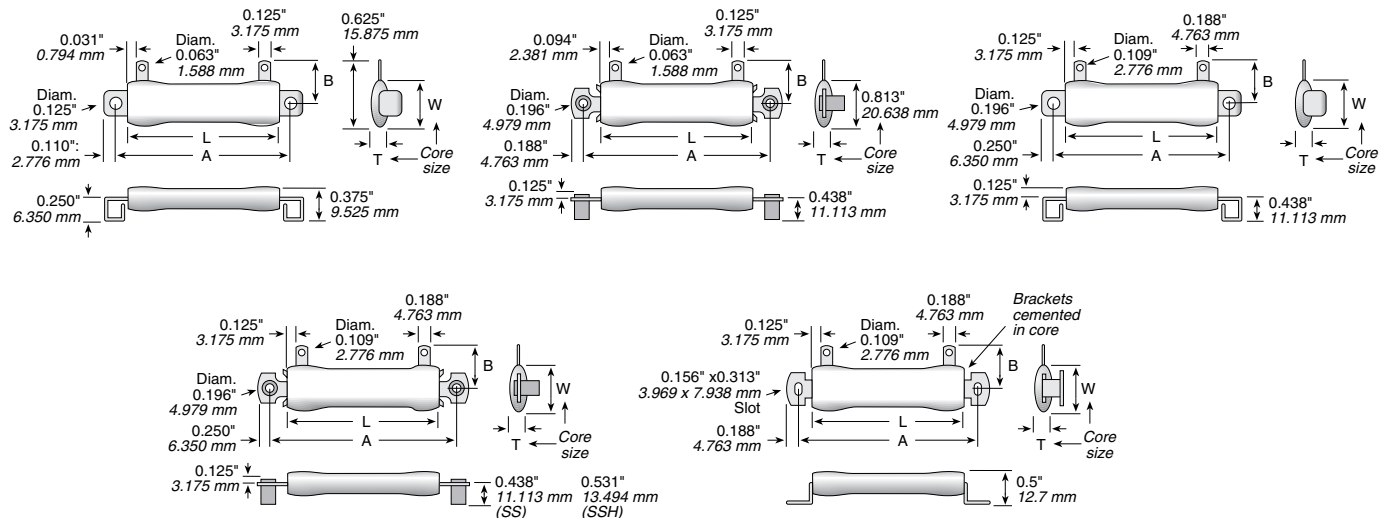

(continued)

250 Series

'Thin' Stackohm® Vitreous Enamel Power

CORE AND TERMINAL SELECTION

For Made to Order Type 250 Stackohm Resistors

Free Air Wattage Rating*	Core Dimensions†			Min. Ohms	Max. Practical Ohms	Code for Core Dia.	Fig. No.	Dimension A	Dimension B	Standard Terminal
	Length L	Width W	Thickness T							
Miniature										
10	0.750" (19.050mm)	0.375" (9.525mm)	0.125" (3.175mm)	1	15,000	TA	1	1.000" (25.400mm)	0.375" (9.525mm)	51
15	1.000" (25.400mm)	0.375" (9.525mm)	0.125" (3.175mm)	1	25,000	TA	1	1.250" (31.750mm)	0.375" (9.525mm)	51
20	2.000" (50.800mm)	0.375" (9.525mm)	0.125" (3.175mm)	1	50,000	TA	1	2.313" (58.750mm)	0.375" (9.525mm)	51
12	0.688" (17.463mm)	0.594" (15.081mm)	0.234" (5.953mm)	1	20,000	TB	**			51
Intermediate										
21	1.000" (25.400mm)	0.813" (20.638mm)	0.250" (6.350mm)	1	8,000	TD	2	1.313" (33.350mm)	0.594" (15.081mm)	51
25	1.500" (38.100mm)	0.813" (20.638mm)	0.250" (6.350mm)	1	15,000	TD	2	1.813" (46.050mm)	0.594" (15.081mm)	51
Standard										
30	1.250" (31.750mm)	1.000" (25.400mm)	0.250" (6.350mm)	1	10,000	TE	3, 4	1.750" (44.450mm) 2.000" (50.800mm)	0.938" (23.813mm)	57
40	2.000" (50.800mm)	1.000" (25.400mm)	0.250" (6.350mm)	1	25,000	TE	3, 4	2.500" (63.500mm) 2.750" (69.850mm)	0.938" (23.813mm)	57
55	3.500" (88.900mm)	1.000" (25.400mm)	0.250" (6.350mm)	1	30,000	TE	3, 4	4.000" (11.600mm) 4.250" (107.950mm)	0.938" (23.813mm)	57
70	4.750" (120.650mm)	1.000" (25.400mm)	0.250" (6.350mm)	1	120,000‡	TE	3, 4	5.250" (133.350mm) 5.500" (139.700mm)	0.938" (23.813mm)	57
95	6.000" (152.400mm)	1.000" (25.400mm)	0.250" (6.350mm)	1	150,000‡	TE	3, 4	6.500" (165.100mm) 6.750" (171.450mm)	0.938" (23.813mm)	57

*Based on mounting on steel panel 10" (254mm) x 10" x 0.040" (1.016mm).

‡These sizes are Ohmicone (silicone-ceramic) coated-type 450-460.

†Inside dimensions of core are: 0.250" (6.350mm) x 0.047" (1.191mm) for TA; 0.406" (10.319mm) x 0.047" (1.191mm) for TB; 0.438" (11.113mm) x 0.063" (1.588mm) for TD; 0.672" (17.069mm) x 0.063" (1.588mm) for TE.

**User supplies brackets.

ORDERING INFORMATION



Made-to-order Parts

See website for custom core info

Terminal Type: See "Resistor Terminals for Tubular Cores"

Tolerance: J = 5% | RoHS Compliant

2 5 3 0 T E 5 7 B 1 R 0 0 J E

Series: Vitreous enamel: 25 = 250 Fixed, 26 = 260 Adjustable; Silicone ceramic: 45 = 450 Fixed, 46 = 460 Adjustable

Wattage & Core Code: See "Core and Terminal Selection"

Mounting Brackets: (user supplies bracket for core TB) B = Stacking box, S = Stacking stud, std. height, H = Stacking stud high, U = Unit type

Ohms: Example: 1R00 = 1Ω, 250R = 250Ω, 1K00 = 1,000Ω, 25K0 = 25,000Ω, 25K5 = 25,500Ω

Standard Values

Ohmic value	Part No. Prefix Suffix	Wattage					Ohmic value	Part No. Prefix Suffix	Wattage					Ohmic value	Part No. Prefix Suffix	Wattage					
		10	20	30	40	55			10	20	30	40	55			10	20	30	40	55	
1	—1R0E	✓	✓	✓	✓	✓	50	—50RE	✓	✓	✓	✓	✓	1,500	—1K5E	✓	✓	✓	✓	✓	✓ = Standard values; check availability at www.ohmite.com
1.5	—1R5E	✓	✓	✓	✓	✓	75	—75RE	✓	✓	✓	✓	✓	2,000	—2K0E	✓	✓	✓	✓	✓	
2	—2R0E	✓	✓	✓	✓	✓	100	—100E	✓	✓	✓	✓	✓	2,500	—2K5E	✓	✓	✓	✓	✓	
3	—3R0E	✓	✓	✓	✓	✓	150	—150E	✓	✓	✓	✓	✓	3,000	—3K0E	✓	✓	✓	✓	✓	
4	—4R0E	✓	✓	✓	✓	✓	200	—200E	✓	✓	✓	✓	✓	4,000	—4K0E	✓	✓	✓	✓	✓	
5	—5R0E	✓	✓	✓	✓	✓	250	—250E	✓	✓	✓	✓	✓	5,000	—5K0E	✓	✓	✓	✓	✓	
7.5	—7R5E	✓	✓	✓	✓	✓	300	—300E	✓	✓	✓	✓	✓	6,000	—6K0E	✓	✓	✓	✓	✓	
10	—10RE	✓	✓	✓	✓	✓	400	—400E	✓	✓	✓	✓	✓	7,500	—7K5E	✓	✓	✓	✓	✓	
15	—15RE	✓	✓	✓	✓	✓	500	—500E	✓	✓	✓	✓	✓	10,000	—10KE	✓	✓	✓	✓	✓	
20	—20RE	✓	✓	✓	✓	✓	750	—750E	✓	✓	✓	✓	✓	15,000	—15KE	✓	✓	✓	✓	✓	
25	—25RE	✓	✓	✓	✓	✓	800	—800E	✓	✓	✓	✓	✓	20,000	—20KE	✓	✓	✓	✓	✓	
30	—30RE	✓	✓	✓	✓	✓	1,000	—1K0E	✓	✓	✓	✓	✓	25,000	—25KE	✓	✓	✓	✓	✓	
40	—40RE	✓	✓	✓	✓	✓	1,250	—1K25E	✓	✓	✓	✓	✓	40,000	—40KE	✓	✓	✓	✓	✓	