

# TCH Series

## 35 Watt TO220 Package Thick Film Power

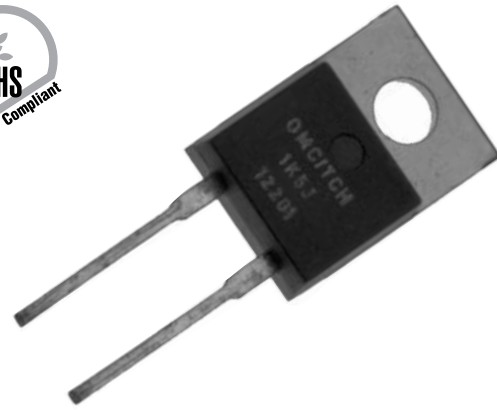

Ohmite's TCH35 TO220 package resistor provides 35W of steady state power when properly used in today's well defined heat sink applications.

These very low inductance resistors are built under proprietary processes that deliver more power handling capability than other TO220 package resistors of similar size.

Standard terminal forms are provided for manual or automatic insertion.

A single screw mounting tab connects to the heat sink and should be accompanied by the use of a thermal compound. The TCH35 Series offers a low thermal resistance to the heat sink of <math><4.28^{\circ}\text{C}/\text{W}</math>.

### FEATURES

- 35W Power Rating @ 25°C
- Very Low Inductance Design
- Single Screw Mounting
- Low Thermal Resistance to Heat Sink @  $R_{\text{TH}} < 4.28^{\circ}\text{C}/\text{W}$
- Resistance Element is Electrically Insulated from Metal Heat Sink Mounting Tab

### APPLICATIONS

- Switching Power Supplies
- Snubbers
- High Frequency
- Voltage Regulation
- Low Energy Pulse Loading

## CHARACTERISTICS

<b>Resistance Range</b>	0.1Ω to 10KΩ (higher values on request subject to derating)
<b>Resistance Tolerance:</b>	± 5% standard; ± 1% available on request
<b>Temperature Coefficient</b>	Referenced to 25°C, ΔR taken at +105°C 10Ω and above: ±50 ppm°C For under 10Ω: OR6 - 9R9: 100PPM OR4 - 0R59: 150PPM OR2 - 0R39: 250PPM OR1 - 0R19: 500PPM OR05 - 0R09: 1000PPM
<b>Max. Operating Voltage</b>	350V
<b>Dielectric Strength</b>	1800 VAC
<b>Insulation Resistance</b>	10GΩ min.
<b>Momentary Overload</b>	2x rated power for 5 seconds as long as the applied voltage ≤ 1.5 times the continuous operating voltage, where ΔR ±(0.3% + 0.01Ω) max
<b>Terminal Material</b>	Copper
<b>Terminal Plating</b>	Lead Free Solder (97% Tin, 3% Silver)
<b>Maximum Torque</b>	0.9 Nm
<b>Power Rating</b>	35 Watts @ 25°C case temperature; see derating curve, below
<b>Working Temperature Range</b>	-55°C to +175°C
<b>Solder Process</b>	The TCH35 cannot exceed 260°C for more than 10 seconds during soldering process

Test	Condition	Result ΔR
<b>Load Life</b>	MIL-R-39009, 2000 Hours @ Rated Pwr	±(1.0% +0.01) Ω
<b>Thermal Shock</b>	MIL-R-STD-202, Method 107, Cond. F	±(0.3% +0.01) Ω max
<b>High Freq Vibration</b>	MIL-R-STD-202, Method 204, Cond. D	±(0.2% +0.01) Ω max
<b>Terminal Strength</b>	MIL-R-STD-202, Method 211, Cond. A (Pull Test) 2.4N	±(0.2% +0.01) Ω max
<b>Moisture Resistance</b>	MIL-R-STD-202, Method 106	± (0.5% +0.01) Ω max

### Derating

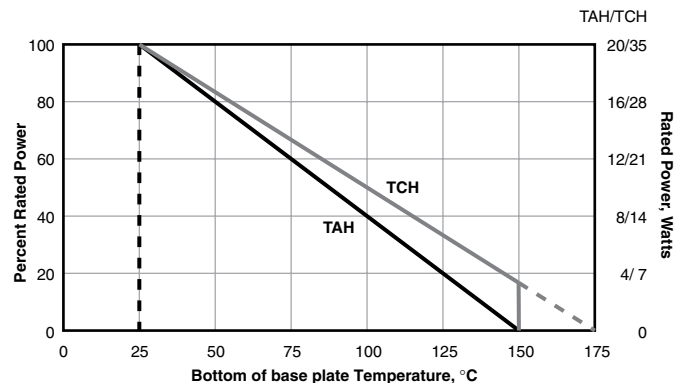

(continued)

# TCH Series

## 35 Watt TO220 Package Thick Film Power

### DIMENSIONS

(in./mm)

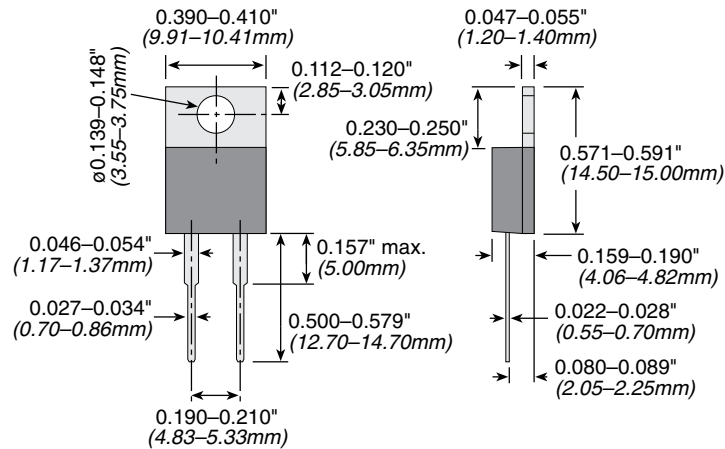

### ORDERING INFORMATION

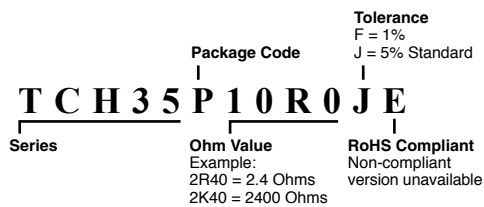

#### Standard Part Numbers

TCH35P100RJE	TCH35P220RJE	TCH35P330RJE	TCH35P510RJE	TCH35PR200JE
TCH35P10K0JE	TCH35P22R0JE	TCH35P390RJE	TCH35P510RJE	TCH35PR220JE
TCH35P10R0JE	TCH35P240RJE	TCH35P39R0JE	TCH35P5K10JE	TCH35PR240JE
TCH35P150RJE	TCH35P24R0JE	TCH35P3K30JE	TCH35P5R10JE	TCH35PR330JE
TCH35P15R0JE	TCH35P2K00JE	TCH35P3K90JE	TCH35P5R60JE	TCH35PR390JE
TCH35P1K00JE	TCH35P2K20JE	TCH35P3R30JE	TCH35P750RJE	TCH35PR470JE
TCH35P1K50JE	TCH35P2K40JE	TCH35P3R90JE	TCH35P75R0JE	TCH35PR510JE
TCH35P1R00JE	TCH35P2R00JE	TCH35P470RJE	TCH35P7K50JE	TCH35PR560JE
TCH35P1R50JE	TCH35P2R20JE	TCH35P47R0JE	TCH35P7R50JE	TCH35PR750JE
TCH35P200RJE	TCH35P2R40JE	TCH35P4K70JE	TCH35PR100JE	TCH35PR050JE
TCH35P20R0JE	TCH35P330RJE	TCH35P4R70JE	TCH35PR150JE	

### THIS PRODUCT IS DESIGNED FOR USE WITH PROPER HEATSINKING.

Maximum base plate temperature of the resistor must be monitored and kept within specified limits to establish the power rating. Best technique is to attach a thermocouple to the side of the base plate of the resistor. Temperature of plastic housing or heat sink cannot be used to establish rating of the resistor.