

Water- and Environment-resistive FA Connectors Save Wiring and Maintenance Effort

- Compact FA connectors meet IP67 requirements and ensure a 94V-0 fire retardant rating.
- A wide array of connectors makes a wiring system more modular, simplifies maintenance, and reduces downtime.
- Connectors with Cables and Connector Assemblies are available.
- Three types of Connector Assembly: Crimping, soldering, and screw-on.
- Connectors with Cables are UL certified.
- Based on IEC61076-2-101 (IEC 60947-5-2) and NECA 4202.



Refer to *Safety Precautions* on page 20.

Construction (XS2G Soldering Connector Plug Assemblies)

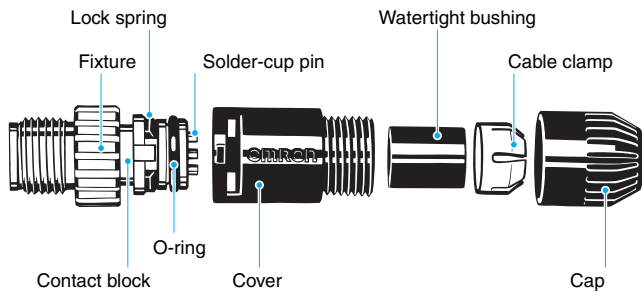

Ratings and Specifications

| | |
|--|---|
| Rated current | 3 A |
| Rated voltage | For DC 125 VDC, for AC 250 VAC |
| Contact resistance (Connector) | 40 mΩ max. (20 mV max., 100 mA max.) |
| Insulation resistance | 1,000 MΩ min. (at 500 VDC) |
| Dielectric strength (Connector) | 1,500 VAC for 1 min (leakage current: 1 mA max.) |
| Degree of protection | IP67 (IEC529) |
| Insertion tolerance | 200 times min. |
| Assembled fixture strength | Tensile: 98 N/15 s Torsion: 0.98 N·m/15 s |
| Cable holding strength | Cable diameter: 6 mm 98 N/15 s 4 to 5 mm 49 N/15 s 3 mm 29 N/15 s |
| Ambient operating temperature range | Operating: -25°C to 70°C |
| Ambient humidity range | 20% to 85% |

Recommended Cables

| Cable outer diameter | Core sizes | | |
|----------------------|-----------------|--|------------------------------|
| | Crimping models | Soldering models | Screw-on models |
| 8 mm | 7 to 8 mm | --- | --- |
| 7 mm | 6 to 7 mm | --- | --- |
| 6 mm | 5 to 6 mm | Two types of contacts are available. • 0.18 to 0.3 mm ² • 0.5 to 0.75 mm ² | 0.18 to 0.75 mm ² |
| 4 mm | 4 to 5 mm | | |
| 3 mm | 3 to 4 mm | | |

Materials and Finish

| Item | XS2F/H/W | XS2M/R/P | XS2C/G |
|------------------------------|---------------------|---------------------------------------|---------------------|
| Contacts | Materials | Phosphor bronze | Brass |
| | Finish | Nickel base, 0.4-μm gold plating | |
| Thread bracket | Materials | Brass * | |
| | Finish | Nickel plated * | |
| Pin block | Materials | PBT resin (UL94V-0) | PBT resin (UL94V-0) |
| | Finish | For DC: light gray; for AC: dark gray | |
| O-ring/rubber bushing | Rubber | | |
| Cover | PBT resin (UL94V-0) | --- | PBT resin (UL94V-0) |
| Cap | --- | --- | PBT resin (UL94V-0) |
| Cable clamp | --- | --- | PA resin (UL94V-0) |
| Pin clamp | --- | --- | PBT resin (UL94V-0) |
| Lock spring | --- | --- | LCP resin (UL94V-0) |
| Watertight bushing | --- | --- | Rubber |
| Ring | --- | --- | Steel |

*The T-joint of the XS2R is aluminum/white.

Socket Appearance

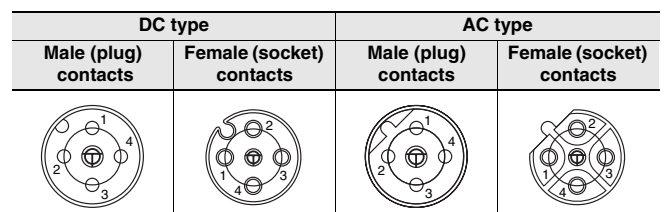

Note: The AC and DC connectors are different as shown here and therefore cannot be connected together.

List of Products

| Name | Model | | Appearance |
|--|---|--------------------------------------|---|
| 1. Connectors attached to Cable | XS2W Sockets and Plugs on Cable Ends | |  |
| | XS2F Sockets on One Cable End | |  |
| | XS2H Plugs on One Cable End | |  |
| 2. Connector Assemblies (Crimping, Soldering, or Screw-on) Used to enable using connectors for sensor cables and relay cables. | XS2G Plug Assemblies | |  |
| | XS2C Socket Assemblies | |  |
| | XY2F Crimp Tool (for Crimping Connectors) | |  |
| | XW4Z Screwdriver (for Screw-on Connectors) | |  |
| 3. Terminal Box Connectors Used to enable using connectors for terminal boxes. | XS2P Panel-mounting Sockets | |  |
| 4. T-Joints and Y-Joints Used for branching and for daisy-chain connections. | XS2R T-Joint/Y-Joint Plug/Socket Connectors | T-Joints |  |
| | | Y-Joints |  |
| 5. Sensor Connector Assemblies Used to enable using connectors in sensors. | XS2M Plugs | Embedded Plugs with Screw Threads |  |
| | | Embedded Plugs with No Screw Threads |  |
| 6. Panel-mounting Connectors Used to enable using I/O box connectors mounted to panels. | XS2M Plugs | Flange-mounting Plugs |  |
| | | Screw-mounting Plugs |  |

XS2W Sockets and Plugs on Cable Ends

Model Number Legend

Use this model number legend to identify products from their model number. When ordering, use a model number from the table in *Ordering Information*.

XS2W-D **2** - **1** -

1
2
3
4
5
6
7
8
9

1. Type

W: Connectors connected to cable, socket and plug on cable ends

2. AC/DC (Mating Section Form)

D: For DC

3. Connector Poles

4: 4 poles

5: 5 poles

4. Contact Plating

2: 0.4-μm gold plating

5. Cable Connection Direction

1: Straight/straight

2: L-shaped/L-shaped

3: Straight (XS2F)/L-shaped (XS2H)

4: L-shaped (XS2F)/straight (XS2H)

6. Cable Length

A: 0.3 m (straight/straight only)

B: 0.5 m (straight/straight only)

C: 1 m (straight/straight only)

D: 2 m

E: 3 m (straight/straight only)

F: 4 m (straight/straight only)

G: 5 m

H: 7 m (straight/straight only)

J: 10 m (straight/straight only)

K: 15 m (straight/straight only)

L: 20 m (straight/straight only)

7. Connections

Pin No.

①

②

③

④

8: Brown White Blue Black (for DC)

Terminal No.

①

②

③

④

⑤

G: Brown White Blue Black Gray

8. Connectors on One End/Both Ends

1: Both ends

9. Cable Specifications

A: Standard cable

R: Vibration-proof robot cable (straight/straight only)

F: Fire-retardant, vibration-proof cable

XS2W Sockets and Plugs on Cable Ends

- Connectors with Standard Cable XS2W-D42□-□81-A
- Connectors with Vibration-proof Robot Cable (Straight/Straight) XS2W-D421-□81-R

Dimensions

(Unit: mm)

Straight/Straight Connectors

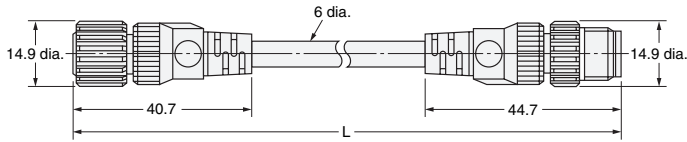

L-shaped/L-shaped Connectors



Straight/L-shaped Connectors



L-shaped/Straight Connectors



Wiring Diagram for 4 Cores



Wiring Diagram for 5 Cores

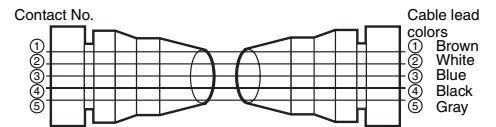

Ordering Information

| Cable type | Cable connection direction | No. of cable cores | Cable core cross-sectional area (mm ²) | Cable length (m) | DC | | UL-listed | |
|-----------------------------|----------------------------|--------------------|--|-------------------|-----------------|-----------------|-----------|----|
| | | | | | Model | Minimum order | | |
| Standard cable | Straight/Straight | 4 | 0.5 | 1 | XS2W-D421-C81-A | 10 | Yes | |
| | | | | 2 | XS2W-D421-D81-A | | | |
| | | | | 5 | XS2W-D421-G81-A | | | |
| | | | | 10 | XS2W-D421-J81-A | | | |
| | L-shaped/L-shaped | | | 2 | XS2W-D422-D81-A | 10 | | |
| | | | | 5 | XS2W-D422-G81-A | 5 | | |
| | | | | Straight/L-shaped | 2 | XS2W-D423-D81-A | | 10 |
| | | | | | 5 | XS2W-D423-G81-A | | 5 |
| L-shaped/Straight | 2 | XS2W-D424-D81-A | 10 | | | | | |
| | 5 | XS2W-D424-G81-A | 5 | | | | | |
| Vibration-proof robot cable | Straight/Straight | 1 | XS2W-D421-C81-R | 10 | Yes | | | |
| | | 2 | XS2W-D421-D81-R | | | | | |
| | | 5 | XS2W-D421-G81-R | | | | | |
| | | 10 | XS2W-D421-J81-R | | | | | |

Note: Ask your OMRON representative about other cable lengths, and about 5-core cables.

XS2F Socket on One Cable End

Model Number Legend

Use this model number legend to identify products from their model number. When ordering, use a model number from the table in *Ordering Information*.

XS2F- **2** - **0**-

1
2
3
4
5
6
7
8
9

1. Type

F: Connector connected to cable, socket on one cable end

2. AC/DC (Mating Section Form)

A: For AC
D: For DC
E: For DC, stainless steel lock

3. Connector Poles

4: 4 poles
5: 5 poles

4. Contact Plating

2: 0.4- μ m gold plating

5. Cable Connection Direction

1: Straight
2: L-shaped

6. Cable Length

A: 0.3 m
B: 0.5 m
C: 1 m
D: 2 m
E: 3 m
F: 4 m
G: 5 m
H: 7 m
J: 10 m
K: 15 m
L: 20 m

Only the 2 m (D) and 5 m (G) cables are available for cables with 5 poles.

7. Connections

| Terminal No. | ① | ② | ③ | ④ |
|--------------|-------|-------|-------|----------------|
| A: | Brown | --- | --- | Blue (for DC) |
| B: | --- | --- | Brown | Blue (for DC) |
| C: | Brown | --- | Blue | Black |
| D: | --- | --- | Blue | Brown |
| 8: | Brown | White | Blue | Black (for DC) |
| 9: | Brown | White | Blue | Black (for AC) |

8. Connectors on One End/Both Ends

0: One end

9. Cable Specifications

A: Standard cable
R: Vibration-proof robot cable
F: Fire-retardant, vibration-proof cable
E: Heat-resistant cable up to 105°C
R type is a 2- or 4-core cable. F or E type is a 4-core cable.

Designations for DC Polarity (For Limit Switches and Sensors)

6. Cable Length

3: 2 m
4: 5 m

7. Connections

| Pin No. | ① | ② | ③ | ④ |
|---------|-----|-----|-------|-------|
| 1: | --- | --- | Black | White |

8. Connectors on One End/Both Ends

0: One end

9. Cable Specifications

Not designated.

Note: Model number standards are different for items 6, 7, and 9 for non-polar connectors.

| Terminal No. | ① | ② | ③ | ④ | ⑤ |
|--------------|-------|-------|------|-------|------|
| G: | Brown | White | Blue | Black | Gray |

XS2F Sockets on One Cable End

- Connectors with Standard Cable XS2F-□42□-□□0-A
- Connectors with Vibration-proof Robot Cable XS2F-□42□-□□0-R
- Non-polar DC Connectors with Standard Cable XS2F-□42□-□□0

Dimensions

(Unit: mm)

Straight Connectors

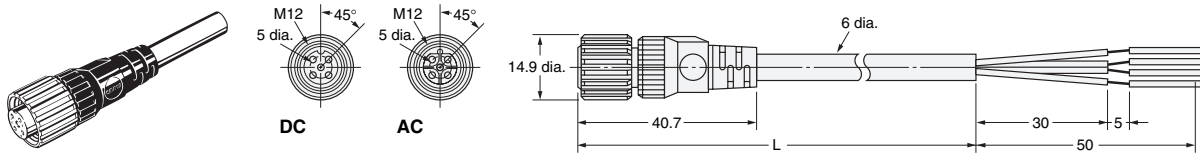

L-shaped Connectors



Wiring Diagram

| | | Two-core model | Three-core model | Four-core model |
|---|-----------------|----------------|------------------|-----------------|
| Standard cable | XS2F-□42□-□□0-A | | | |
| Vibration-proof robot cable | XS2F-□42□-□□0-R | | | |
| Standard cable (non-polar DC) | XS2F-□42□-□□0 | | --- | --- |
| Standard cable (E2E models with conventional connector pin) | XS2F-D42□-□D0 | | --- | --- |

Ordering Information

| Cable type | Cable connection direction | No. of cable cores | Cable core cross-sectional area (mm ²) | Cable length (m) | DC | AC | Minimum order | UL-listed |
|---|----------------------------|--------------------|--|------------------|-----------------|-----------------|---------------|-----------|
| | | | | | Model | Model | | |
| Standard cable | Straight | 2 | 0.5 | 1 | XS2F-D421-CA0-A | XS2F-A421-CB0-A | 10 | Yes |
| | | 3 | | | XS2F-D421-CC0-A | --- | | |
| | | 4 | | | XS2F-D421-C80-A | XS2F-A421-C90-A | | |
| | | 2 | | 2 | XS2F-D421-DA0-A | XS2F-A421-DB0-A | | |
| | | 3 | | | XS2F-D421-DC0-A | --- | | |
| | | 4 | | | XS2F-D421-D80-A | XS2F-A421-D90-A | | |
| | | 2 | | 5 | XS2F-D421-GA0-A | XS2F-A421-GB0-A | | |
| | | 3 | | | XS2F-D421-GC0-A | --- | | |
| | | 4 | | | XS2F-D421-G80-A | XS2F-A421-G90-A | | |
| | | 2 | | 10 | XS2F-D421-JA0-A | XS2F-A421-JB0-A | | |
| | 3 | XS2F-D421-JC0-A | | | --- | | | |
| | 4 | XS2F-D421-J80-A | | | XS2F-A421-J90-A | | | |
| | L-shaped | 1 | | 2 | XS2F-D422-CA0-A | XS2F-A422-CB0-A | 10 | |
| | | | | 3 | XS2F-D422-CC0-A | --- | | |
| | | | | 4 | XS2F-D422-C80-A | --- | | |
| | | 2 | | 2 | XS2F-D422-DA0-A | XS2F-A422-DB0-A | | |
| | | | | 3 | XS2F-D422-DC0-A | --- | | |
| | | | | 4 | XS2F-D422-D80-A | --- | | |
| | | 5 | | 2 | XS2F-D422-GA0-A | XS2F-A422-GB0-A | | |
| | | | | 3 | XS2F-D422-GC0-A | --- | | |
| 4 | | | XS2F-D422-G80-A | --- | | | | |
| 10 | | 2 | XS2F-D422-JA0-A | XS2F-A422-JB0-A | | | | |
| | 3 | XS2F-D422-JC0-A | --- | | | | | |
| | 4 | XS2F-D422-J80-A | --- | | | | | |
| Vibration-proof robot cable | Straight | 2 | 0.5 | 1 | XS2F-D421-CA0-R | XS2F-A421-CB0-R | 10 | |
| | | 4 | | | XS2F-D421-C80-R | XS2F-A421-C90-R | | |
| | | 2 | | 2 | XS2F-D421-DA0-R | XS2F-A421-DB0-R | | |
| | | 4 | | | XS2F-D421-D80-R | XS2F-A421-D90-R | | |
| | | 2 | | 5 | XS2F-D421-GA0-R | XS2F-A421-GB0-R | | |
| | | 4 | | | XS2F-D421-G80-R | XS2F-A421-G90-R | | |
| | | 2 | | 10 | XS2F-D421-JA0-R | XS2F-A421-JB0-R | | |
| | 4 | XS2F-D421-J80-R | | | XS2F-A421-J90-R | | | |
| | L-shaped | 1 | | 2 | XS2F-D422-CA0-R | XS2F-A422-CB0-R | 10 | |
| | | | | 4 | XS2F-D422-C80-R | --- | | |
| | | 2 | | 2 | XS2F-D422-DA0-R | XS2F-A422-DB0-R | | |
| | | | | 4 | XS2F-D422-D80-R | --- | | |
| | | 5 | | 2 | XS2F-D422-GA0-R | XS2F-A422-GB0-R | | |
| | | | | 4 | XS2F-D422-G80-R | --- | | |
| 10 | | 2 | XS2F-D422-JA0-R | XS2F-A422-JB0-R | | | | |
| | 4 | XS2F-D422-J80-R | --- | | | | | |
| Standard cable (non-polar) | Straight | 2 | 2 | XS2F-D421-310 | XS2F-A421-310 | 10 | | |
| | | 2 | 5 | XS2F-D421-410 | XS2F-A421-410 | 5 | | |
| | L-shaped | 2 | 2 | XS2F-D422-310 | XS2F-A422-310 | 10 | | |
| | | 2 | 5 | XS2F-D422-410 | XS2F-A422-410 | 5 | | |
| Standard cable (E2E models with conventional connector pin) | Straight | 2 | 2 | XS2F-D421-DD0 | --- | 10 | | |
| | | 2 | 5 | XS2F-D421-GD0 | --- | 5 | | |
| | L-shaped | 2 | 2 | XS2F-D422-DD0 | --- | 10 | | |
| | | 2 | 5 | XS2F-D422-GD0 | --- | 5 | | |
| Heat-resistant cable * | Straight | 4 | 2 | XS2F-E421-D80-E | --- | 10 | | |
| | | | 5 | XS2F-E421-G80-E | --- | 5 | | |
| | L-shaped | | 2 | XS2F-E422-D80-E | --- | 10 | | |
| | | | 5 | XS2F-E422-G80-E | --- | 5 | | |

Note: Ask your OMRON representative about other cable lengths.
 *The heat-resistant fixture material is SUS316L stainless steel without surface treatment.

Applicable Proximity Sensors

Refer to page the *E2E Datasheet* for information on connecting to E2E Proximity Sensors

● 5-pole Connectors for DC XS2F-D521-□G0-A

Dimensions

(Unit: mm)

Straight Connectors

Note: Use the XS2H-D521-□G0-A in combination with the XS2F-D521-□G0-A.



Wiring Diagram

Pin Arrangements (Engagement Side)

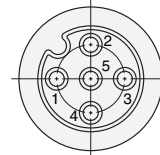

Ordering Information

| No. of cable cores | Cable core cross-sectional area (mm ²) | Cable length (m) | DC | |
|--------------------|--|------------------|-----------------|---------------|
| | | | Model | Minimum order |
| 5 | 0.3 mm ² | 2 | XS2F-D521-DG0-A | 10 |
| | | 5 | XS2F-D521-GG0-A | 5 |

Note: Ask your OMRON representative about other cable lengths.

XS2H Plugs on One Cable End

Model Number Legend

XS2H-□□21-□□0-□

1 2 3 4 5 6 7 8 9

1. Type

H: Connector connected to cable, plug on one cable end

2. AC/DC

A: For AC

D: For DC

3. Connector Poles

4: 4 poles

5: 5 poles

Using this model number legend to identify products from their model number. When ordering, use a model number from the table in *Ordering Information*.

4. Contact Plating

2: 0.4- μ m gold plating

5. Cable Connection Direction

1: Straight

6. Cable Length

A: 0.3 m

B: 0.5 m

C: 1 m

D: 2 m

G: 5 m

7. Connections

Terminal No.

① ② ③ ④

8: Brown White Blue Black (for DC)

9: Brown White Blue Black (for AC)

Terminal No.

① ② ③ ④

A: Brown --- --- Blue (for DC)

B: --- --- Brown Blue (for AC)

C: Brown --- Blue Black (for DC)

Terminal No.

① ② ③ ④ ⑤

G: Brown White Blue Black Gray

8. Connectors on One End/Both Ends

0: One end

9. Cable Specifications

A: Standard cable

F: Fire-retardant, vibration-proof cable

R: Vibration-proof robot cable

R type is a 2 or 4-core cable. F type is a 4-core cable.

XS2H Plugs on One Cable End

● Connectors on Standard Cable XS2H-□421-□□0-A

Dimensions

(Unit: mm)

Straight Connectors

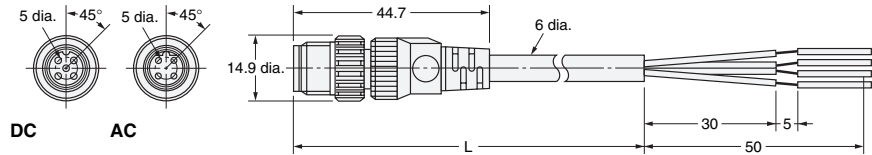
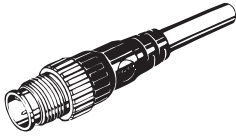

Wiring Diagram



● Connectors on DC Cable (Five Poles) XS2H-D521-□G0-A (for DC)

Dimensions

(Unit: mm)

Straight Connectors

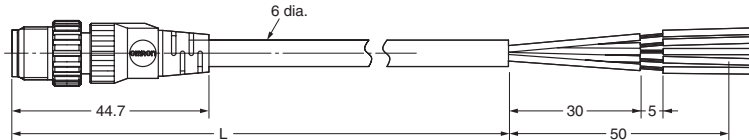
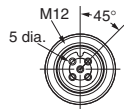

Note: Use the XS2F-D521-□G0-A in combination with the XS2H-D521-□G0-A.

Wiring diagram

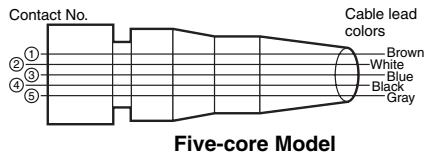

Pin Arrangements (Engagement Side)

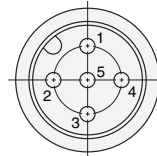

Ordering Information

| No. of connector poles | Cable connection direction | No. of cable cores | Cable core cross-sectional area | Cable length (m) | DC | AC | Minimum order | UL-listed |
|------------------------|----------------------------|--------------------|---------------------------------|------------------|-----------------|-----------------|---------------|-----------|
| | | | | | Model | Model | | |
| 4 | Straight | 2 | 0.5 mm ² | 0.3 | XS2H-D421-AA0-A | XS2H-A421-AB0-A | 10 | Yes |
| | | 3 | | | XS2H-D421-AC0-A | --- | | |
| | | 4 | | | XS2H-D421-A80-A | XS2H-A421-A90-A | | |
| | | 2 | | XS2H-D421-CA0-A | XS2H-A421-CB0-A | | | |
| | | 3 | | XS2H-D421-CC0-A | --- | | | |
| | | 4 | | XS2H-D421-C80-A | XS2H-A421-C90-A | | | |
| 5 | Straight | 5 | 0.3 mm ² | 0.3 | XS2H-D521-AG0-A | --- | --- | |
| | | | | 1 | XS2H-D521-CG0-A | --- | | |

XS2 Sensor I/O Connectors on Cables (8-pole)

Ordering Information

| Connector type | Cable connection direction | Number of cores | Cable length (m) | Model |
|-------------------------------|----------------------------|-----------------|------------------|-----------------|
| Panel-mounting socket | --- | --- | --- | XS2P-D821-2 |
| Panel-mounting plug | | | | XS2P-D822-2 |
| | | | | XS2M-D824-4 |
| Plug on one cable end | Straight | 8 | 0.3 | XS2H-D821-AH0-C |
| Socket on one cable end | | | 1 | XS2H-D821-CH0-C |
| | | | 2 | XS2F-D821-DH0-C |
| | | | 5 | XS2F-D821-GH0-C |
| Plug and socket on cable ends | | | 2 | XS2W-D821-DH1-C |
| | | | 5 | XS2W-D821-GH1-C |

Pin Numbers and Cable Lead Colors

| XS2F/XS2H/XS2W cable lead colors | Pin number | | | | | | | |
|----------------------------------|------------|-------|-------|--------|------|------|------|--------|
| | 1 | 2 | 3 | 4 | 5 | 6 | 7 | 8 |
| | White | Brown | Green | Yellow | Gray | Pink | Blue | Shield |

Ratings and Characteristics

| | |
|-----------------------|---|
| Rated current | 1.5 A |
| Rated voltage | 36 VDC |
| Contact resistance | 40 MΩ max. (at 20 mVDC max. and 100 mA max.) |
| Insulation resistance | 1,000 MΩ min. (at 500 VDC) |
| Dielectric strength | 1,000 VAC for 1 min (leakage current: 1 mA max.) |
| Degree of protection | IP67 |
| Insertion durability | 200 times min. |
| Operating temperature | -25 to 70°C |

Materials and Finish

| | |
|---------------------------|--|
| Contacts | Brass/nickel base, 0.4-μm goldplating |
| Bracket, body, M16 nuts | Brass/nickel plated |
| Pin block | PBT resin (UL94V-0)/light gray |
| Cover *1 | PBT resin (UL94V-0) |
| Seal rubber and O-ring *2 | Rubber |

*1. XS2F/XS2H/XS2W only.

*2. O-rings are on sockets only.

Wiring Example



Dimensions

XS2H Plug on One Cable End (M12)

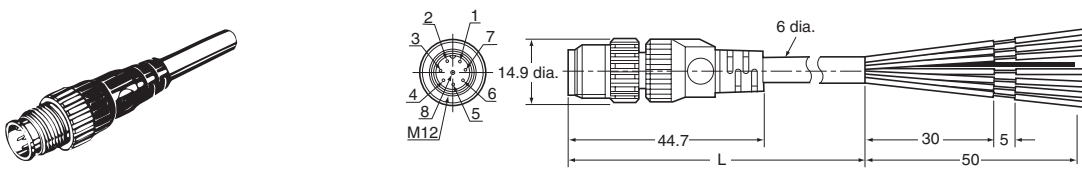

XS2F Socket on One Cable End (M12)



XS2W Plug and Socket on Cable Ends (M12)



XS2P-D821-2 Panel-mounting Socket (M12) with Solder Cup Pins and Rear Lock



XS2M-D824-4 Panel-mounting Plug (M12) with Solder Cup Pins and Front Lock



XS2P-D822-2 Panel-mounting Socket (M12) with Solder Cup Pins and Front Lock



Panel Cutouts



Connector Pin Numbers (from Mating Side)



- Note 1. Mounting panel thickness: 1 to 4 mm.
- 2. Applicable core wire size for solder cup pins: 0.5 mm² max.
- 3. The M16 nut and seal rubber are included.

XS2G Crimping/Soldering Plug Assemblies

Dimensions

(Unit: mm)

XS2G-□4C□ (Crimping Model)
 XS2G-□42□ (Soldering Model)
 Straight Connectors

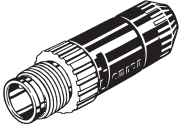

XS2G-D42□ (Soldering Model)
 L-shaped Connectors

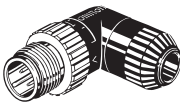

Ordering Information

| Suitable cable dia. (mm) | Cable connection direction | Connection method | DC | AC | Minimum order |
|-------------------------------------|----------------------------|-------------------|-----------|-----------|---------------|
| | | | Model | Model | |
| 6-mm-dia. model (5 to 6 mm dia.) | Straight | Crimping | XS2G-D4C1 | XS2G-A4C1 | 50 |
| | L-shaped | Soldering | XS2G-D421 | XS2G-A421 | |
| 4-mm-dia. model (4 to 5 mm dia.) | | Straight | Crimping | XS2G-D4C3 | |
| | L-shaped | Soldering | XS2G-D423 | XS2G-A423 | |
| 3-mm-dia. model (3 to 4 mm dia.) | | Straight | Crimping | XS2G-D4C5 | |
| | L-shaped | Soldering | XS2G-D425 | XS2G-A425 | |
| | | Soldering | XS2G-D426 | --- | |

Note: Crimping plug contacts are sold separately.

XS2U Crimping Pin for XS2G

Dimensions

(Unit: mm)

XS2U-312□ (Plug Pin)

Note: A special tool must be used for crimping. For details, refer to page 23.

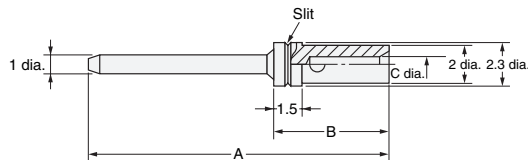

Dimensions

| Model | Suitable core size (mm ²) | Dimension (mm) | | | No. of slits |
|-----------|---------------------------------------|----------------|-----|-----|--------------|
| | | A | B | C | |
| XS2U-3121 | 0.18 to 0.3 | 20.0 | 6.1 | 0.8 | 1 |
| XS2U-3122 | 0.5 to 0.75 | 20.1 | 6.2 | 1.3 | 0 |

Ordering Information

| Suitable core size (mm ²) | Model | Minimum order |
|---------------------------------------|-----------|---------------|
| 0.18 to 0.3 | XS2U-3121 | 100 |
| 0.5 to 0.75 | XS2U-3122 | |

Note: Orders are accepted in multiples of the minimum order.

XS2C Crimping/Soldering Socket Assemblies

Dimensions

(Unit: mm)

XS2C-□4C□ (Crimping Model)
 XS2C-□42□ (Soldering Model)
 Straight Connectors



L-shaped Connectors

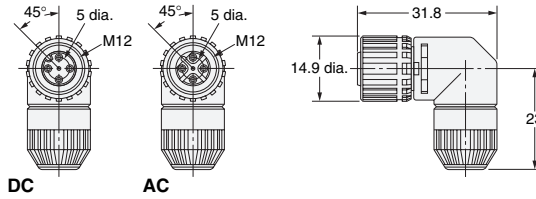

Ordering Information

| Suitable cable dia. (mm) | Cable connection direction | Connection method | DC | AC | Minimum order |
|-------------------------------------|----------------------------|-------------------|-----------|-----------|---------------|
| | | | Model | Model | |
| 6-mm-dia. model (5 to 6 mm dia.) | Straight | Crimping | XS2C-D4C1 | XS2C-A4C1 | 50 |
| | | Soldering | XS2C-D421 | XS2C-A421 | |
| | L-shaped | Crimping | XS2C-D4C2 | XS2C-A4C2 | |
| | | Soldering | XS2C-D422 | XS2C-A422 | |
| 4-mm-dia. model (4 to 5 mm dia.) | Straight | Crimping | XS2C-D4C3 | XS2C-A4C3 | |
| | | Soldering | XS2C-D423 | XS2C-A423 | |
| | L-shaped | Crimping | XS2C-D4C4 | XS2C-A4C4 | |
| | | Soldering | XS2C-D424 | XS2C-A424 | |
| 3-mm-dia. model (3 to 4 mm dia.) | Straight | Crimping | XS2C-D4C5 | XS2C-A4C5 | |
| | | Soldering | XS2C-D425 | XS2C-A425 | |
| | L-shaped | Crimping | XS2C-D4C6 | XS2C-A4C6 | |
| | | Soldering | XS2C-D426 | XS2C-A426 | |

Note: Crimping plug contacts are sold separately.

XS2U Crimping Pin for XS2C

Dimensions

(Unit: mm)

XS2U-222□ (Socket Pin)

Note: A special tool must be used for crimping. For details, refer to page 23.



Dimensions

| Model | Suitable core size (mm ²) | Dimension (mm) | | | No. of slits |
|-----------|---------------------------------------|----------------|-----|-----|--------------|
| | | A | B | C | |
| XS2U-2221 | 0.18 to 0.3 | 16.7 | 6.1 | 0.8 | 1 |
| XS2U-2222 | 0.5 to 0.75 | 16.8 | 6.2 | 1.3 | 0 |

Ordering Information

| Suitable core size (mm ²) | Model | Minimum order |
|---------------------------------------|-----------|---------------|
| 0.18 to 0.3 | XS2U-2221 | 100 |
| 0.5 to 0.75 | XS2U-2222 | |

Note: Orders are accepted in multiples of the minimum order.

XS2G Screw-on Plug Assemblies

Dimensions

(Unit: mm)

- XS2G-D5S7 (5-pole, Straight, Applicable Cable Outer Diameter: 8 mm)
- XS2G-D5S9 (5-pole, Straight, Applicable Cable Outer Diameter: 7 mm)
- XS2G-D4S7 (4-pole, Straight, Applicable Cable Outer Diameter: 8 mm)
- XS2G-D4S9 (4-pole, Straight, Applicable Cable Outer Diameter: 7 mm)



- XS2G-D5S1 (5-pole, Straight, Applicable Cable Outer Diameter: 6 mm)
- XS2G-D4S□ (4-pole, Straight, Applicable Cable Outer Diameter: 3, 4, or 6 mm)



- XS2G-D5S2 (5-pole, L-shaped, Applicable Cable Outer Diameter: 6 mm)
- XS2G-D4S□ (4-pole, L-shaped, Applicable Cable Outer Diameter: 3, 4, or 6 mm)



Ordering Information

| No. of poles | Suitable cable dia. (mm) | Straight connectors (for DC) | L-shaped connectors (for DC) | Minimum order |
|--------------|----------------------------------|------------------------------|------------------------------|---------------|
| | | Model | Model | |
| 5 | 8-mm-dia. model (7 to 8 mm dia.) | XS2G-D5S7 | --- | 50 |
| | 7-mm-dia. model (6 to 7 mm dia.) | XS2G-D5S9 | --- | |
| | 6-mm-dia. model (5 to 6 mm dia.) | XS2G-D5S1 | XS2G-D5S2 | |
| 4 | 8-mm-dia. model (7 to 8 mm dia.) | XS2G-D4S7 | --- | |
| | 7-mm-dia. model (6 to 7 mm dia.) | XS2G-D4S9 | --- | |
| | 6-mm-dia. model (5 to 6 mm dia.) | XS2G-D4S1 | XS2G-D4S2 | |
| | 4-mm-dia. model (4 to 5 mm dia.) | XS2G-D4S3 | XS2G-D4S4 | |
| | 3-mm-dia. model (3 to 4 mm dia.) | XS2G-D4S5 | XS2G-D4S6 | |

Note: XS2G Screw-on Plugs cannot be connected to side by side to the CN1 and CN2 connectors of XS2R Y-Joint Sockets/Plugs.

XS2C Screw-on Socket Assemblies

Dimensions

(Unit: mm)

XS2C-D5S7 (5-pole, Straight, Applicable Cable Outer Diameter: 8 mm)

XS2C-D5S9 (5-pole, Straight, Applicable Cable Outer Diameter: 7 mm)

XS2C-D4S7 (4-pole, Straight, Applicable Cable Outer Diameter: 8 mm)

XS2C-D4S9 (4-pole, Straight, Applicable Cable Outer Diameter: 7 mm)

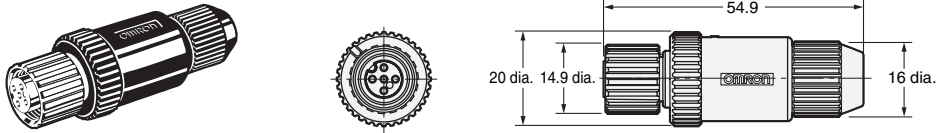

XS2C-D5S1 (5-pole, Straight, Applicable Cable Outer Diameter: 6 mm)

XS2C-D4S□ (4-pole, Straight, Applicable Cable Outer Diameter: 3, 4, or 6 mm)

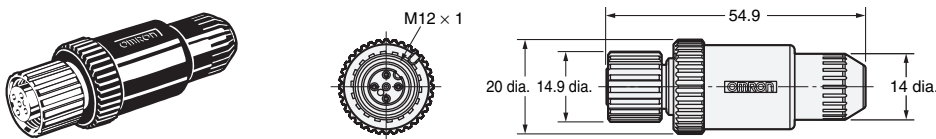

XS2C-D5S2 (5-pole, L-shaped, Applicable Cable Outer Diameter: 6 mm)

XS2C-D4S□ (4-pole, L-shaped, Applicable Cable Outer Diameter: 3, 4, or 6 mm)

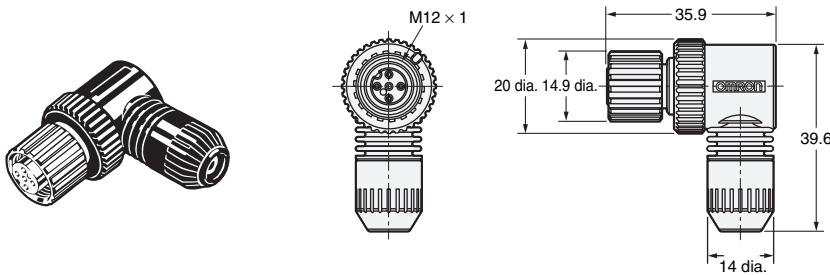

Ordering Information

| No. of poles | Suitable cable dia. (mm) | Straight connectors (for DC) | | L-shaped connectors (for DC) | | Minimum order |
|--------------|----------------------------------|------------------------------|-------|------------------------------|-------|---------------|
| | | Model | Model | Model | Model | |
| 5 | 8-mm-dia. model (7 to 8 mm dia.) | XS2C-D5S7 | --- | --- | --- | 50 |
| | 7-mm-dia. model (6 to 7 mm dia.) | XS2C-D5S9 | --- | --- | --- | |
| | 6-mm-dia. model (5 to 6 mm dia.) | XS2C-D5S1 | --- | XS2C-D5S2 | --- | |
| 4 | 8-mm-dia. model (7 to 8 mm dia.) | XS2C-D4S7 | --- | --- | --- | |
| | 7-mm-dia. model (6 to 7 mm dia.) | XS2C-D4S9 | --- | --- | --- | |
| | 6-mm-dia. model (5 to 6 mm dia.) | XS2C-D4S1 | --- | XS2C-D4S2 | --- | |
| | 4-mm-dia. model (4 to 5 mm dia.) | XS2C-D4S3 | --- | XS2C-D4S4 | --- | |
| | 3-mm-dia. model (3 to 4 mm dia.) | XS2C-D4S5 | --- | XS2C-D4S6 | --- | |

XS2P Panel-mounting Sockets for Terminal Boxes

Dimensions

(Unit: mm)

XS2P-□421-2 (with Solder Cup Pins) Rear Lock Model

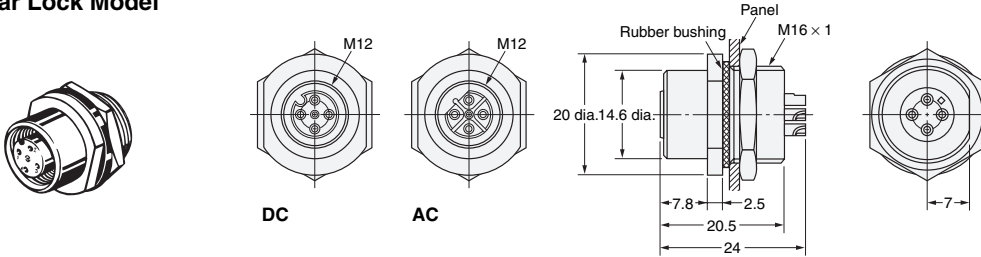

XS2P-□422-1 (with DIP Pins) XS2P-□422-2 (with Solder Cup Pins) Front Lock Model

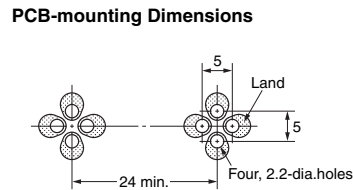
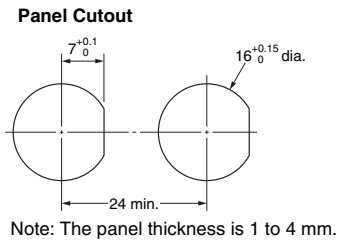
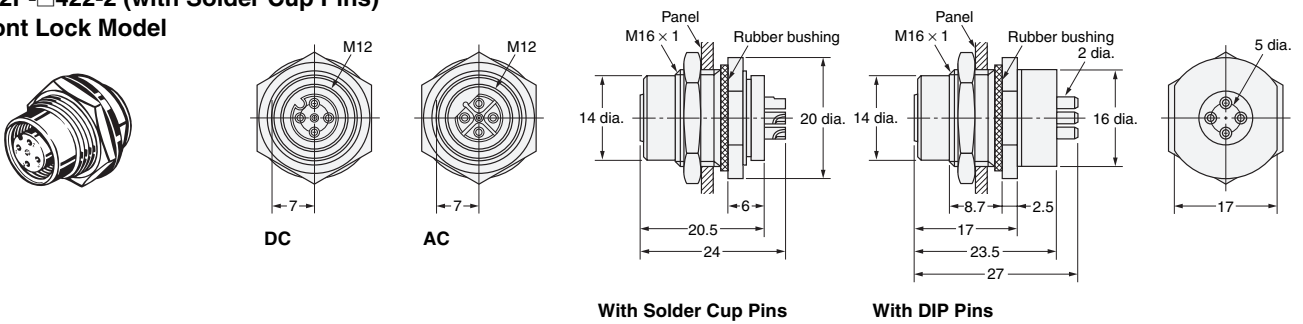

Ordering Information

| Lock method | Pin shape | DC | AC | Minimum order |
|-------------|----------------|----------------|-------------|---------------|
| | | Model | Model | |
| Rear lock | Solder cup pin | XS2P-D421-2 | XS2P-A421-2 | 50 |
| | Front lock | Solder cup pin | XS2P-D422-2 | |
| | DIP pin | XS2P-D422-1 | XS2P-A422-1 | |

XS2R Y-Joint Plug/Socket Connectors

Dimensions

(Unit: mm)

XS2R-D426-□11-F

Connectors on Both Cable Ends (Y-Joint Plug/Socket)

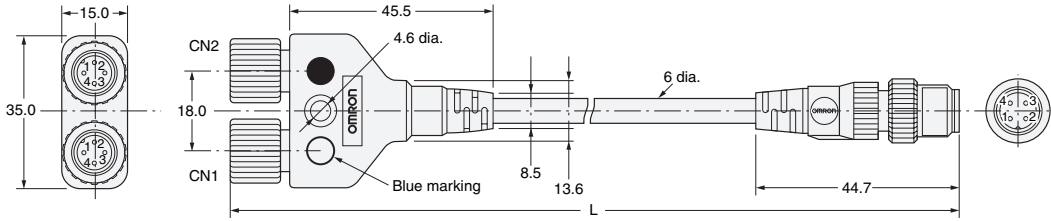

Wiring Diagram



XS2R-D426-□10-F

Connectors on One Cable End (Y-Joint Plug/Socket)



Wiring Diagram



XS2R-D426-1

Y-Joint Plug/Socket without Cable

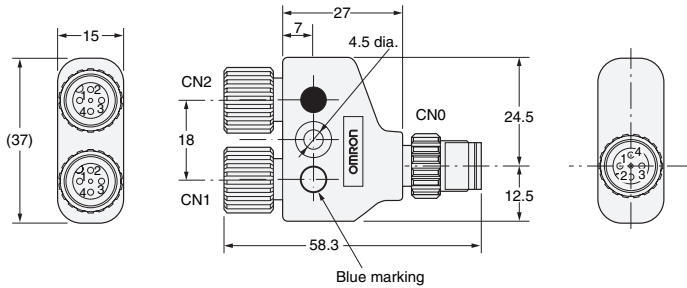

Wiring Diagram

XS2R-D426-1

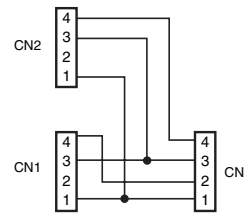

XS2R-D426-5

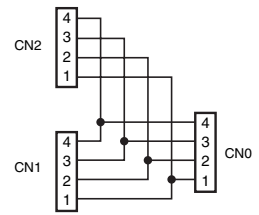

XS2R-D426-81

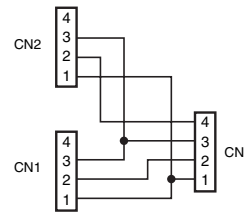

XS2R-D426-82

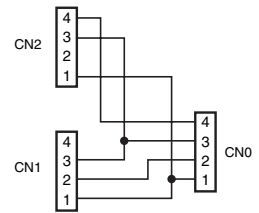

Ordering Information

| Type | Connector | DC | | |
|---------------|-------------------------------|--------------------|-----------------|---------------|
| | | Cable length L (m) | Model | Minimum order |
| With cable | Connectors on both cable ends | 0.5 | XS2R-D426-B11-F | 5 |
| | | 1 | XS2R-D426-C11-F | |
| | | 2 | XS2R-D426-D11-F | |
| | | 3 | XS2R-D426-E11-F | |
| | Connector on one cable end | 2 | XS2R-D426-D10-F | |
| | | 5 | XS2R-D426-G10-F | |
| Without cable | Y-Joint plug/socket | --- | XS2R-D426-1 | 10 |
| | | --- | XS2R-D426-5 | |
| | | --- | XS2R-D426-81 | |
| | | --- | XS2R-D426-82 | |

Note: XS2G Screw-on Plugs cannot be connected side-by-side to the CN1 and CN2 connectors. Consider using a crimping or soldering model instead. Refer to page 13 for details.

XS2R T-Joint Plug/Socket Connectors

Dimensions

(Unit: mm)

XS2R-D422-1
XS2R-D422-5
Aggregate Models

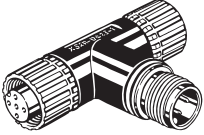

Wiring Diagram
XS2R-D422-1



XS2R-D422-5



XS2R-D423-1
Bifurcated Model



Wiring Diagram

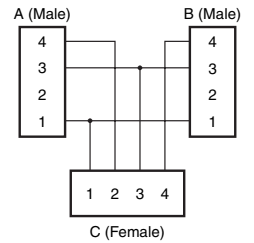

XS2R-D424-1
Daisy-chain Model

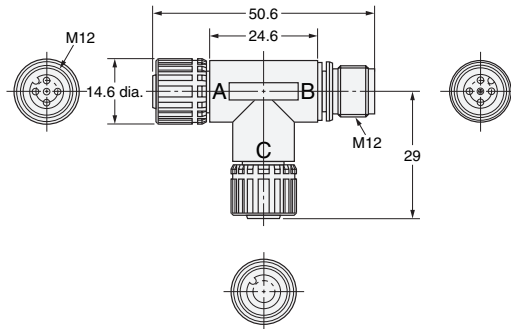

Wiring Diagram

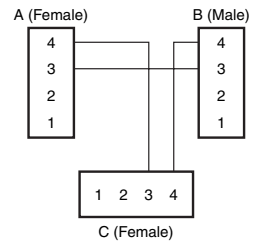

Ordering Information

| Type | DC | |
|-------------------|-------------|---------------|
| | Model | Minimum order |
| Aggregate model | XS2R-D422-1 | 20 |
| | XS2R-D422-5 | |
| Bifurcated model | XS2R-D423-1 | |
| Daisy-chain model | XS2R-D424-1 | |

XS2R Application Examples

XS2R-D422-1 (Aggregate Model)



- A pair of Two-wire Sensors or Three-wire Sensors can be connected as shown in the illustration.
- The XS2R-D422-5 has feedthrough connections, thus working as a connector for the extension cable.



XS2R-D423-1 (Bifurcated Model)

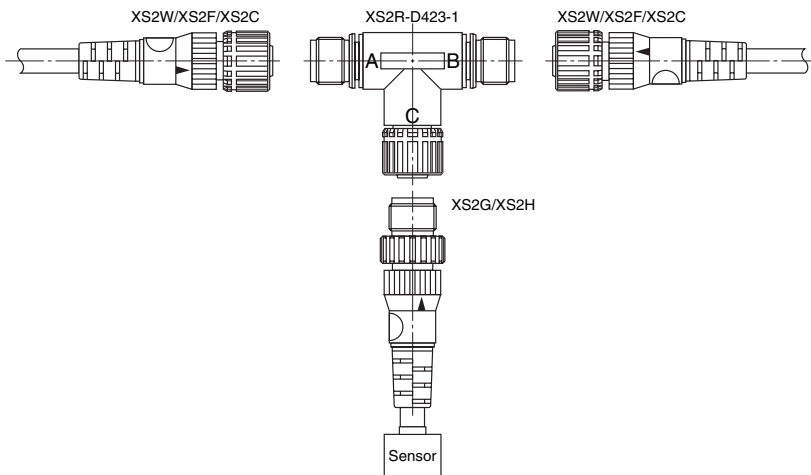

- Two or Three-wire Sensor signals can be bifurcated.

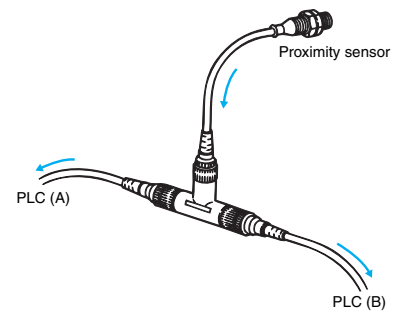

XS2R-D424-1 (Daisy Chain Model)



- Two-wire Sensors with contact output can be connected through a daisy chain to obtain AND output.

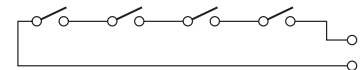

Safety Precautions

Precautions for Correct Use

Do not use this product under ambient conditions that exceed the ratings.

Before using the XS2R for Sensors, make sure that the wiring of the Sensors and the internal connections of the XS2R are correct.

XS2M Sensor-embedded Plugs

Dimensions

(Unit: mm)

XS2M-D421 (DC)
XS2M-A421 (AC)
(Embedded Plug with Screw Threads)

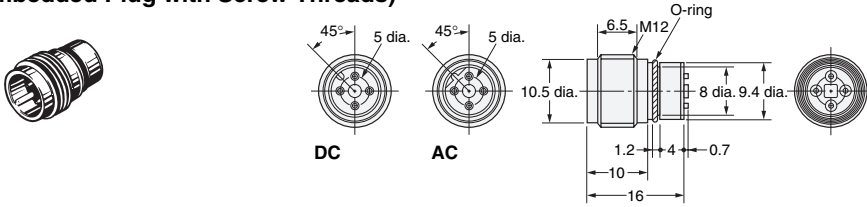

Mounted Dimensions



Note: After mounting, anchor the solder cups by injecting resin.

XS2M-D422 (DC)
XS2M-A422 (AC)
(Embedded Plug without Screw Threads)

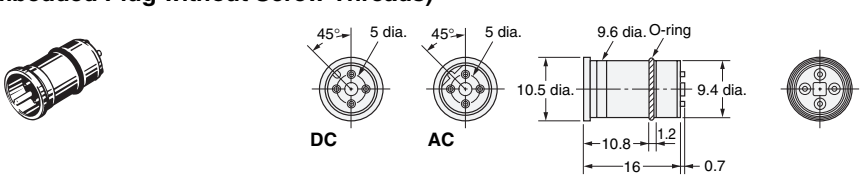

Mounted Dimensions

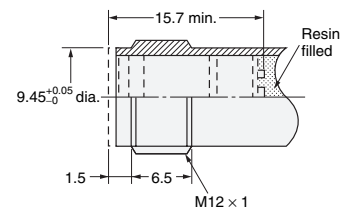

Note: After mounting, anchor the solder cups by injecting resin.

XS2M Panel-mounting Plugs

Dimensions

(Unit: mm)

XS2M-D423 (For DC)
XS2M-A423 (For AC)
(Flange-mounting Model)



Panel Cutouts

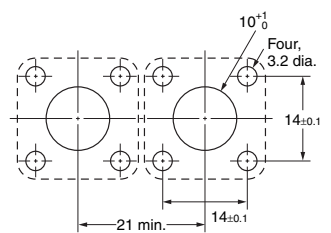

XS2M-□424-1 (With DIP Pins)
XS2M-□424-2 (With Solder Cup Pins)
(Screw-mounting Model)



Panel Cutouts



Note: The panel thickness is 1 to 4 mm.

PCB-mounting Dimensions

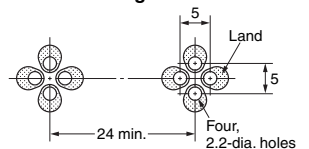

Ordering Information

| Mounting method | Pin shape | DC | AC | Minimum order |
|--------------------------------|----------------|-------------|-------------|---------------|
| | | Model | Model | |
| Embedded with screw threads | Solder cup pin | XS2M-D421 | XS2M-A421 | 50 |
| Embedded with no screw threads | | XS2M-D422 | XS2M-A422 | |
| Flange-mounting | | XS2M-D423 | XS2M-A423 | |
| Screw-mounting | DIP pin | XS2M-D424-1 | XS2M-A424-1 | |
| | Solder cup pin | XS2M-D424-2 | XS2M-A424-2 | |

Connector Covers

Water-resistant Covers

XS2Z-11

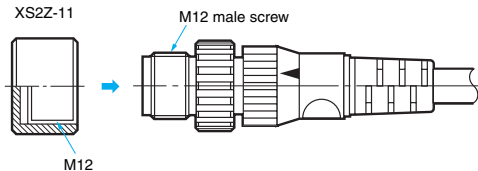

XS2Z-22

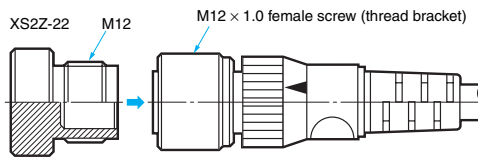

The Water-resistant Cover ensures IP67. When mounting the Water-resistant Cover to a Connector, be sure to apply a torque range between 0.39 and 0.49 N·m to tighten the Water-resistant Cover.

| Model | Minimum order | Material | Suitable connector | |
|---------|---------------|---------------------|--|-----------------------------------|
| | | | Model | Mounting portion |
| XS2Z-11 | 50 | Brass/nickel plated | XS2G/XS2H/XS2M/XS2R/XS2W/XS5H/XS5M/XS5W | M12 male screw |
| XS2Z-22 | | | XS2C/XS2R/XS2F/XS2P/XS2W/XW3B/XS5F/XS5W/XS5R/XS5P/XW3D | M12 female screw (thread bracket) |

Dust Covers

XS2Z-13

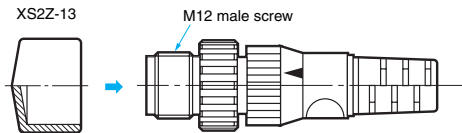

XS2Z-15/XS2Z-14

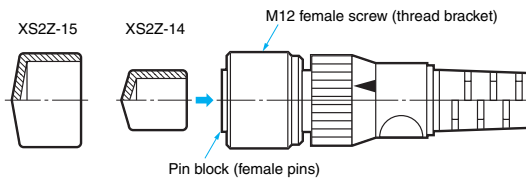

The Dust Cover is for dust prevention and does not ensure IP67 degree of protection. When mounting the Dust Cover to a connector, be sure to press the Dust Cover onto the Connector until the Connector is fully inserted into the Dust Cover.

| Model | Minimum order | Material | Suitable connector | |
|---------|---------------|--------------|-------------------------------|-----------------------------------|
| | | | Model | Mounting portion |
| XS2Z-13 | 50 | Rubber/black | XS2G/XS2H/XS2M/XS2R | M12 male screw |
| XS2Z-14 | | | XS2C/XS2R/XS2F/XS2P/XW3A/XW3B | Pin block (female pins) |
| XS2Z-15 | | | | M12 female screw (thread bracket) |

Sputter Protective Cover

XS2Z-31

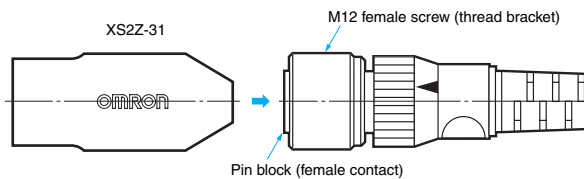

The Sputter Protective Cover protects the connector from weld spatter. Make sure it covers the entire connector.

| Model | Material | Applicable connector |
|---------|-----------------------|----------------------|
| XS2Z-31 | Silicone rubber/black | XS2F/XS2H/XS2W |

Tools

Crimp Tool

XY2F-0002



Locator

XY2F-0003

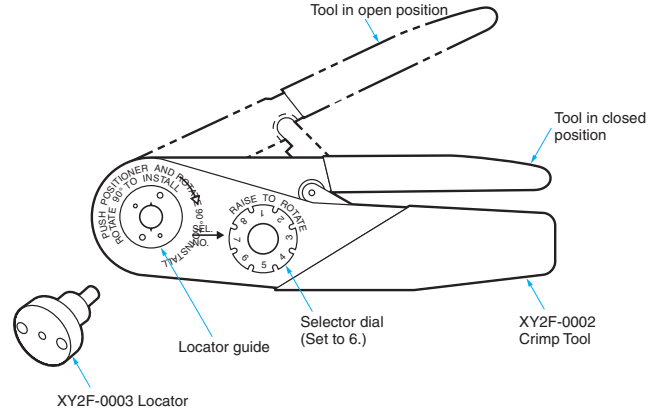

Use the Crimp Tool to crimp a cable core to the XS2U Crimping Pin used with the XS2C or XS2G Crimping Connector.

- The XY2F-0002 Crimp Tool is DMC's AFM8 (M22520/2-01).
- Mount the XY2F-0003 Locator (sold separately) to the locator guide of the Crimp Tool with a screw provided with the XY2F-0003 Locator.

Pin-block Extraction Tool

XY2F-0001

Use this tool to extract a Pin Block from the covers in order to make wiring changes or corrections after the cover has been mounted to the pin block for Connector Assemblies (XS2C/ XS2G, soldering/crimping).



Extraction Procedure

(1) Disconnecting Components

- Disconnect all components on the cap side from the cover.



- Make sure that the pin block is outside the Tool.



- Press the Tool so that the guides of the Tool are in close contact. Then pull the pin block straight.



(2) Extracting Pin Block

- Insert the claws of the Tool into the four holes of the cover.



Precaution

- The pin block must not be extracted from the same Connector more than 3 times, otherwise the proper degree of protection of the pin block or Connector will not be maintained.

Assembly Procedure for XS2C/XS2G Connector Assemblies

(1) Connector and Cable External Diameters

- Connectors for 6-, 4-, and 3-mm-diameter Cables (i.e., Cables that are 5 to 6, 4 to 5, and 3 to 4 mm in diameter respectively) are available. When assembling a Connector used with a cable, make sure that the external diameter of the Connector is suited to that of the cable.
- Connectors for 6-mm-diameter Cables use white cable clamps. Connectors for 4- and 3-mm-diameter Cables use black cable clamps.
A watertight bushing for 6-mm-diameter Cable has no stripe, that for 4-mm-diameter Cable has a single stripe, and that for 3-mm-diameter Cable has two stripes.

Note: When connecting a commercially available cable to a connector assembly, use a cable with an outside diameter of 3 to 6 mm and core sizes of 0.18 to 0.75 mm² for crimping connectors and 0.5 mm² maximum for soldering connectors.

(2) Component Insertion

Crimping/Soldering Connectors

Straight Connectors

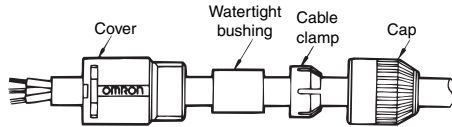

L-shaped Connectors

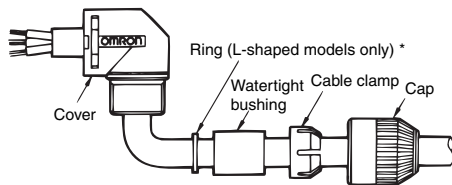

*A ring is not required for Screw-on Connectors.

- As shown in the above illustration, connect the above components to the Cable with its end processed.

Screw-on Connectors

Confirm that you have all of the required parts.



Insulation caps and insulation tubes are included with 5-pole Connectors (XS2C-D5S□ and XS2G-D5S□).

- *1. Rings are not required with 7-mm and 8-mm cables.
- *2. Insert the waterproof bushing for 7-mm and 8-mm cables in the direction shown in the diagram.

(3) Wiring (Processing Cable Ends)

Soldering Connectors

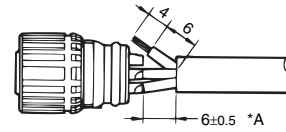

- Strip 10 mm of the Cable sheath and 4 mm of each core.
- Before soldering cores and solder cup pins together, solder-coat each of them.
- The following conditions are recommended for soldering each solder cup pin.
Soldering iron: 30 to 60 W
Soldering temperature: 280°C to 340°C
Soldering period: 3 s max.
- The length marked *A should be 6.5 mm max., otherwise the proper degree of protection of the connector will not be maintained.

Crimping Connectors

Crimping

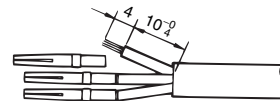

- Strip 14 mm of the Cable sheath and 4 mm of each core.
- Make sure that each core is not damaged and its end strands are not spread out.
- Mount the XY2F-0003 Locator to DMC's AFM8 (M25520/2-01) Crimping Tool, both of which are sold separately, and set the selector dial of the Crimping Tool to 6 for the XS2U-□□21 and to 7 for the XS2U-□□22.
- After mounting the crimping pins to the Locator, fully insert the cores to the crimping pins.
- Squeeze the handle of the Crimp Tool to press-fit the cores to the crimping pins.
(Squeeze the handle firmly until the handle automatically returns to the release position.)

Wiring

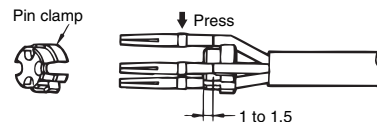

- After press-fitting the cores to the pins, insert the pins into the pin clamp as shown in the illustration. Then make sure that the lead colors correspond to the pin clamp numbers that are identical to the connector pin numbers.

Insertion



- Tentatively insert the pins to the pin block holes so that the key on the pin block will coincide with the key groove on the pin clamp. Then insert the cable along with the pin clamp.

Screw-on Connectors

Cable End Processing

• Four-pole Connectors



- Loosen the screws on pins 1 to 4 and insert the cores according to the pin numbers.



- Use the special Screwdriver (XW4Z-00B) * and tighten the screws securely so that the cores do not pull out (tightening torque: 0.15 to 0.2 N·m).

• Five-pole Connectors

- Strip the cable sheath for a total of 15 mm and strip the core covering for 8 mm for the core to connect to pin 5.



- Connect the core to pin 5 (in the center) first.
- Insert the core from the side of the hold with the tab and tighten the screw securely (tightening torque: 0.15 to 0.2 N·m), and then cut off the excess wire with wire cutters.



- Bend the cable as shown below, attached the enclosed insulation cap, and then strip the other cores.



- Connect the cores to pins 1 to 4.

Connecting Shielded Cables to Five-pole Connectors

- Place the insulation tub on the drain line of the shield and connect it to the terminal.
- Tighten the screw and then check visually to see if there is insulation between the cores.

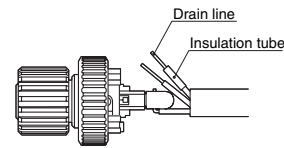

- Connect the cores to pins 1 to 4.

*When tightening the screws, use the dedicated XW4Z-00B Screwdriver that matches with the screw-slot dimensions.



XW4Z-00B Screwdriver

(4) Inserting Pin Block

Pin Block (Soldering Model)

Cover (Straight Model)

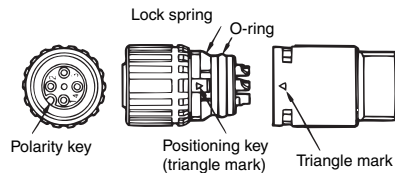

(Crimping Model)

(L-shaped Model)

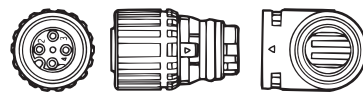

- Mount the cover to the pin block so that the triangle mark on the pin block will coincide with the triangle mark on the cover.
- If the cover is used for an L-shaped model, the relationship between the position of the polarity key on the engaged side and cable connection direction will be determined by the direction in which the positioning key is inserted into the cover, which can be rotated by 90°.
- Fully insert the positioning key until the positioning key is hidden by the casing.

Pin Block
(Screw-mounting Connectors) Cover

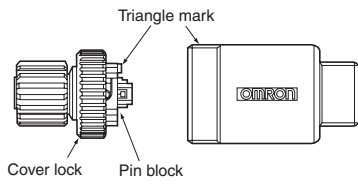

- Align the triangular marks on the pin block and cover and insert the pin block into the cover.
- Press them together firmly (0.39 to 0.49 N·m) until the pin block does not come out of the cover.

(5) Mounting Cap

- After mounting the cover to the pin block and the cover snaps into place, tighten the cap securely by hand within a torque of 0.39 and 0.49 N·m.

Note: If the cap is not tighten securely enough, the degree of protection (IP67) may not be maintained or vibration may cause the cap to become loose. Do not tighten the cap with pliers or similar tools; they may damage the cap.

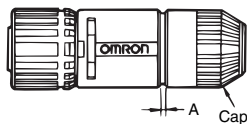

- After fully tightening the cap, length A should be approximately one of the following according to the cable external diameter and the Connector model.

| Connector | Cable external diameter (mm) | | | |
|---------------------|------------------------------|------|------|------|
| | 6 mm | 5 mm | 4 mm | 3 mm |
| For 6-mm-dia. cable | 1 | 0 | --- | --- |
| For 4-mm-dia. cable | --- | 2 | 1 | --- |
| For 3-mm-dia. cable | --- | --- | 2 | 1 |

(6) After Assembly

- Confirm the insulation between cores after completing assembly.

Recommended Cables

When connecting a commercially available cable to a connector assembly, use a cable with an outside diameter of 3 to 6 mm and core sizes of 0.18 to 0.75 mm² for crimping connectors and 0.5 mm² maximum for soldering connectors.

Connector Arrangement

For safety, when constructing a connection system between a Sensor and panel with a connector, make sure that the connector plug is on the Sensor side and the connector socket is on the panel side (i.e., the female pins are located on the power-supply side).

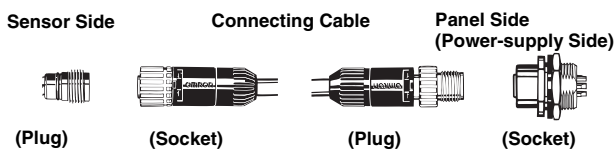

Safety Precautions

Precautions for Correct Use

Do not use the product in atmospheres or environments that exceed product ratings.

Tightening Cap (Connector Assemblies)

1. Do not use pliers to tighten caps, otherwise the caps may be damaged. Be sure to tighten each cap by hand within a torque range between 0.39 and 0.49 N·m.
2. If caps are not tightened securely, the Connectors may not maintain their proper degree of protection (i.e., IP67) or the caps may become loose due to vibration.

Connector Connection and Disconnection

- When connecting or disconnecting Connectors, be sure to hold the Connectors by hand.
- Do not hold the cable part when disconnecting Connectors.
- Connectors mating with sockets must be fully inserted into the sockets. Tighten the thread bracket carefully so that the threads will not be damaged.
- Fully tighten thread bracket within a torque range between 0.39 and 0.49 N·m and be sure that the threads of the opposite parts are hidden by the thread bracket.
- When disconnecting Connectors, be sure to loosen the thread brackets first. Do not loosen the caps.
- Thread brackets must be loosened in the cutout direction.



Degree of Protection

- Do not impose external force continuously on the joints of pin blocks and covers, otherwise the Connectors may not keep its proper degree of protection (i.e., IP67).
- The degree of protection of connectors (IP67) is not for a fully watertight structure. Do not use them underwater.
- Connectors are of resin mold construction. Do not impose excessive force on them.

Setup

- Do not make any cable bends near the base of the Unit.
- Any bends made must have a minimum radius of 40 mm.

Read and Understand This Catalog

Please read and understand this catalog before purchasing the products. Please consult your OMRON representative if you have any questions or comments.

Warranty and Limitations of Liability

WARRANTY

OMRON's exclusive warranty is that the products are free from defects in materials and workmanship for a period of one year (or other period if specified) from date of sale by OMRON.

OMRON MAKES NO WARRANTY OR REPRESENTATION, EXPRESS OR IMPLIED, REGARDING NON-INFRINGEMENT, MERCHANTABILITY, OR FITNESS FOR PARTICULAR PURPOSE OF THE PRODUCTS. ANY BUYER OR USER ACKNOWLEDGES THAT THE BUYER OR USER ALONE HAS DETERMINED THAT THE PRODUCTS WILL SUITABLY MEET THE REQUIREMENTS OF THEIR INTENDED USE. OMRON DISCLAIMS ALL OTHER WARRANTIES, EXPRESS OR IMPLIED.

LIMITATIONS OF LIABILITY

OMRON SHALL NOT BE RESPONSIBLE FOR SPECIAL, INDIRECT, OR CONSEQUENTIAL DAMAGES, LOSS OF PROFITS OR COMMERCIAL LOSS IN ANY WAY CONNECTED WITH THE PRODUCTS, WHETHER SUCH CLAIM IS BASED ON CONTRACT, WARRANTY, NEGLIGENCE, OR STRICT LIABILITY.

In no event shall the responsibility of OMRON for any act exceed the individual price of the product on which liability is asserted.

IN NO EVENT SHALL OMRON BE RESPONSIBLE FOR WARRANTY, REPAIR, OR OTHER CLAIMS REGARDING THE PRODUCTS UNLESS OMRON'S ANALYSIS CONFIRMS THAT THE PRODUCTS WERE PROPERLY HANDLED, STORED, INSTALLED, AND MAINTAINED AND NOT SUBJECT TO CONTAMINATION, ABUSE, MISUSE, OR INAPPROPRIATE MODIFICATION OR REPAIR.

Application Considerations

SUITABILITY FOR USE

OMRON shall not be responsible for conformity with any standards, codes, or regulations that apply to the combination of products in the customer's application or use of the products.

At the customer's request, OMRON will provide applicable third party certification documents identifying ratings and limitations of use that apply to the products. This information by itself is not sufficient for a complete determination of the suitability of the products in combination with the end product, machine, system, or other application or use.

The following are some examples of applications for which particular attention must be given. This is not intended to be an exhaustive list of all possible uses of the products, nor is it intended to imply that the uses listed may be suitable for the products:

- Outdoor use, uses involving potential chemical contamination or electrical interference, or conditions or uses not described in this catalog.
- Nuclear energy control systems, combustion systems, railroad systems, aviation systems, medical equipment, amusement machines, vehicles, safety equipment, and installations subject to separate industry or government regulations.
- Systems, machines, and equipment that could present a risk to life or property.

Please know and observe all prohibitions of use applicable to the products.

NEVER USE THE PRODUCTS FOR AN APPLICATION INVOLVING SERIOUS RISK TO LIFE OR PROPERTY WITHOUT ENSURING THAT THE SYSTEM AS A WHOLE HAS BEEN DESIGNED TO ADDRESS THE RISKS, AND THAT THE OMRON PRODUCTS ARE PROPERLY RATED AND INSTALLED FOR THE INTENDED USE WITHIN THE OVERALL EQUIPMENT OR SYSTEM.

PROGRAMMABLE PRODUCTS

OMRON shall not be responsible for the user's programming of a programmable product, or any consequence thereof.

Disclaimers

CHANGE IN SPECIFICATIONS

Product specifications and accessories may be changed at any time based on improvements and other reasons.

It is our practice to change model numbers when published ratings or features are changed, or when significant construction changes are made. However, some specifications of the products may be changed without any notice. When in doubt, special model numbers may be assigned to fix or establish key specifications for your application on your request. Please consult with your OMRON representative at any time to confirm actual specifications of purchased products.

DIMENSIONS AND WEIGHTS

Dimensions and weights are nominal and are not to be used for manufacturing purposes, even when tolerances are shown.

PERFORMANCE DATA

Performance data given in this catalog is provided as a guide for the user in determining suitability and does not constitute a warranty. It may represent the result of OMRON's test conditions, and the users must correlate it to actual application requirements. Actual performance is subject to the OMRON Warranty and Limitations of Liability.

ERRORS AND OMISSIONS

The information in this document has been carefully checked and is believed to be accurate; however, no responsibility is assumed for clerical, typographical, or proofreading errors, or omissions.

2012.2

In the interest of product improvement, specifications are subject to change without notice.

OMRON Corporation
Industrial Automation Company

<http://www.ia.omron.com/>

(c)Copyright OMRON Corporation 2012 All Right Reserved.