

# DIN Twin-contact Connectors XC5

## A Wide Variety of DIN Connectors That Conform to UL/CSA Standards.

- Fully preserves the characteristics of normal DIN connectors while increasing the number of terminals available.
- Meets world market needs with products ranging from one-piece connectors (card edge) to two-piece connectors.
- Uses a twin-contact system for high reliability and low cost.
- Lower insertion force as a result of FEM analysis techniques.
- Conform to UL standards (file no. E 103202) and CSA standards (file no. LR 62678).

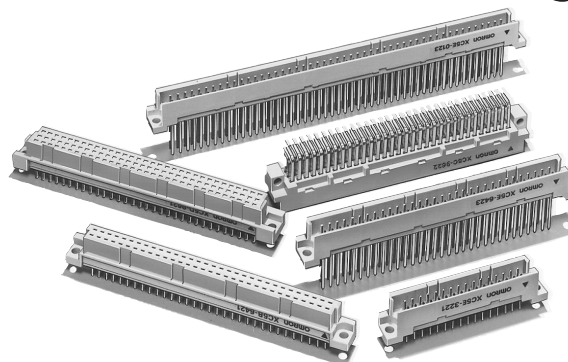

### Structure

**Twin Contacts  
(2-point Contact System)**

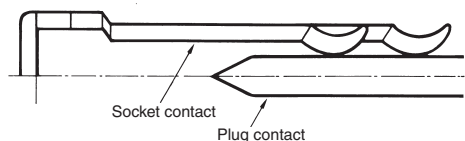

### Low Insertion Force Design

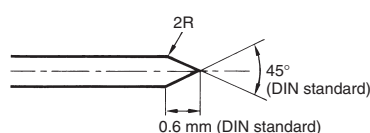

The shape of the Plug contact tip is based on the DIN standard dimensions, however, a small radius, R, has been introduced between the shaft and the tip. This results in less force being required for insertion.

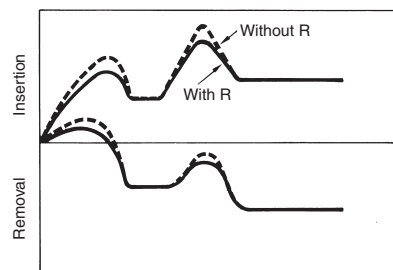

### Connector Styles

#### Double-row Connectors

Model	XC5A B type	XC5B B type	XC5E Q type	XC5F Q type
Appearance	Plug with right-angle terminals 	Socket with straight terminals 	Plug with straight terminals 	Socket with right-angle terminals 

#### Triple-row Connectors

Model	XC5C C type	XC5D C type	XC5G R type	XC5H R type
Appearance	Plug with right-angle terminals 	Socket with straight terminals 	Plug with straight terminals 	Socket with right-angle terminals 

### Ratings and Characteristics

Rated current	2 A
Rated voltage	300 VAC
Contact resistance	20 mΩ max. (at 20 mV, 100 mA max.)
Insulation resistance	10 <sup>6</sup> MΩ min. (at 100 VDC)
Dielectric strength	1,000 VAC for 1 min (leakage current: 1 mA max.)
Connector insertion	0.59 N max. per contact
Contact removal	0.15 N min. (with test gauge, t = 0.56 mm)
Insertion durability	200 times
Ambient temperature	Operating: -55 to 125°C (with no icing)

### Materials and Finish

Item	Plugs	Sockets
Housings	Fiber-glass reinforced PBT resin (UL94V-0)/gray	
Contacts	Mating end	Brass/nickel base, 0.4-μm gold plating (See note 1.)
	Terminal	Brass/nickel base, tin plating
		Phosphor bronze/nickel base, 0.4-μm gold plating (See note 1.)
		Phosphor bronze/nickel base, tin plating

- Note:**
1. For non-standard plating specifications, contact OMRON
  2. Wrap terminal contacts are made from phosphor bronze.
  3. See "Precautions" for information about Wire Wrap terminals

# XC5A Double-row Plugs, DIN B-type (Standard)

## ■ Dimensions

XC5A-□□22

(With right-angle through-hole terminals)

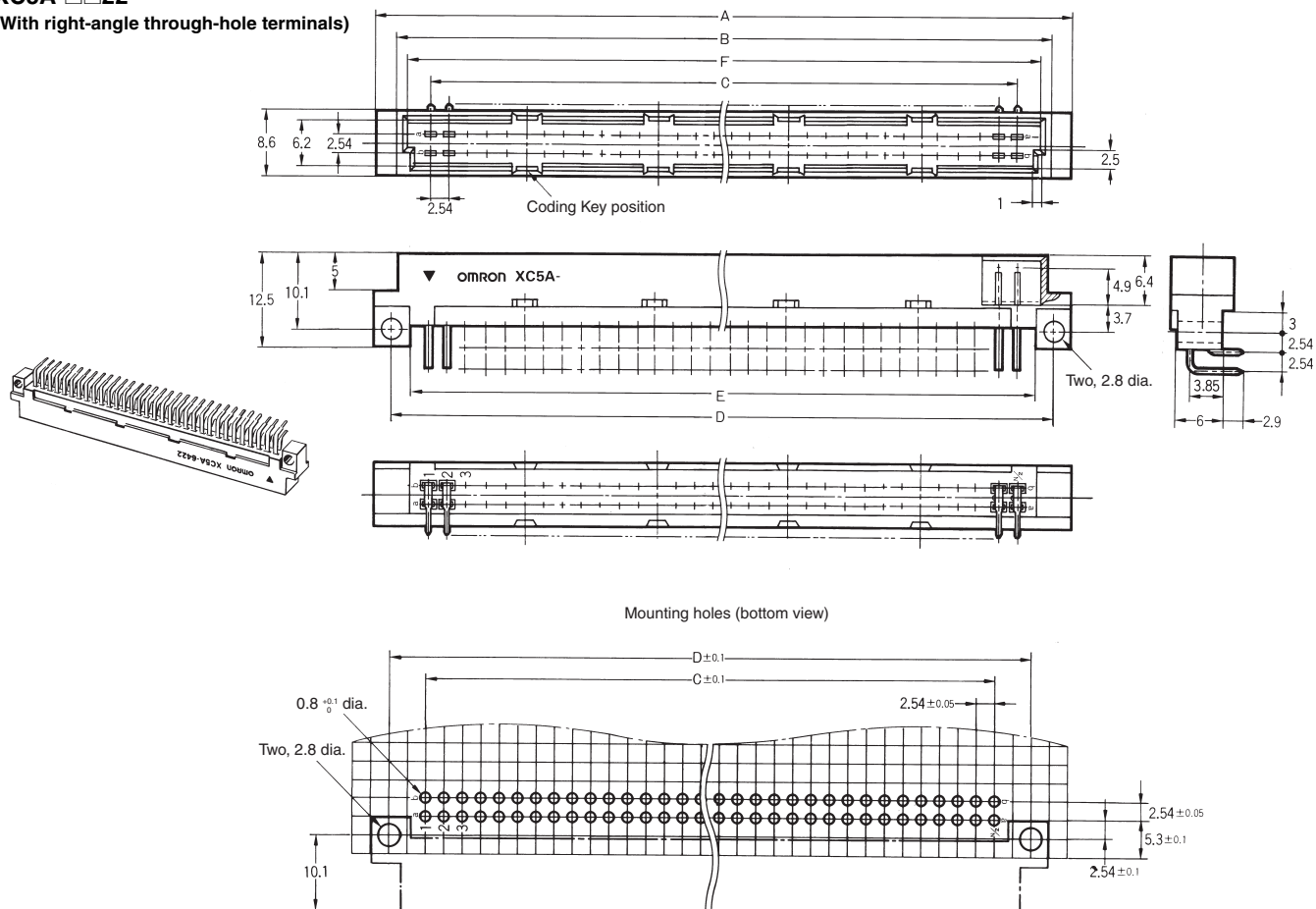

No. of contacts	Dimensions (mm)						Coding Key positions (contact No.)
	A	B	C	D	E	F	
20	37.9	32.1	22.86	33.02	28.1	29.3	3, 8
32	53.2	47.4	38.10	48.26	43.3	44.6	5, 12
44	68.4	62.6	53.34	63.50	58.5	59.8	4, 9, 14, 19
50	76.0	70.2	60.96	71.12	66.2	67.4	5, 10, 16, 21
64	93.8	88.0	78.74	88.90	83.9	85.2	6, 13, 20, 27
100	139.5	133.7	124.46	134.62	129.7	130.9	10, 20, 31, 41

## ■ Ordering Information

No. of contacts	Terminal type	Model
20*	Right-angle through-hole terminals	XC5A-2022
32		XC5A-3222
44*		XC5A-4422
50*		XC5A-5022
64		XC5A-6422
100*		XC5A-0122

\*Marked items have an increased number of contacts while following DIN standards.

# XC5B Double-row Sockets, DIN B-type (Standard)

## ■ Dimensions

### XC5B-□□21

(With straight through-hole terminals)

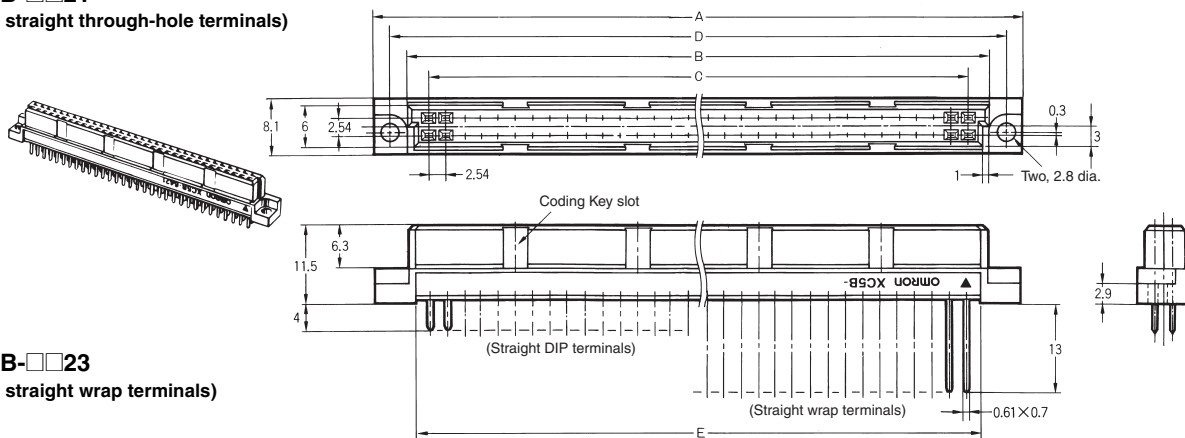

### XC5B-□□23

(With straight wrap terminals)

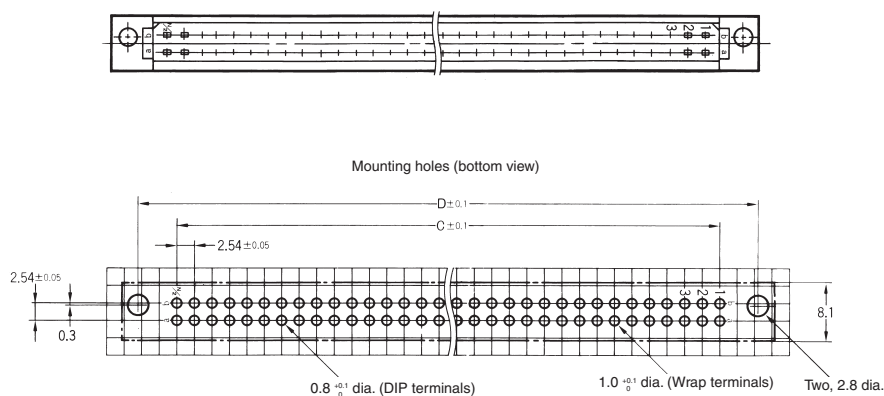
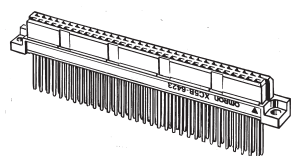

No. of contacts	Dimensions (mm)					Coding Key slot positions (contact No.)
	A	B	C	D	E	
20	38.9	29.1	22.86	34.12	27.1	3, 8
32	54.2	44.4	38.10	49.36	42.3	5, 12
44	69.4	59.6	53.34	64.60	57.5	4, 9, 14, 19
50	77.0	67.2	60.96	72.22	65.2	5, 10, 16, 21
64	94.8	85.0	78.74	90.00	82.9	6, 13, 20, 27
100	140.5	130.7	124.46	135.72	128.7	10, 20, 31, 41

## ■ Ordering Information

No. of contacts	Terminal type	
	Straight Through-hole terminals	Straight wrap terminals
20*	XC5B-2021	XC5B-2023
32	XC5B-3221	XC5B-3223
44*	XC5B-4421	XC5B-4423
50*	XC5B-5021	XC5B-5023
64	XC5B-6421	XC5B-6423
100*	XC5B-0121	XC5B-0123

\*Marked items have an increased number of contacts while following DIN standards.

# XC5E Double-row Plugs, DIN Q-type (Reverse)

## ■ Dimensions

XC5E-□□21

(With straight through-hole terminals)

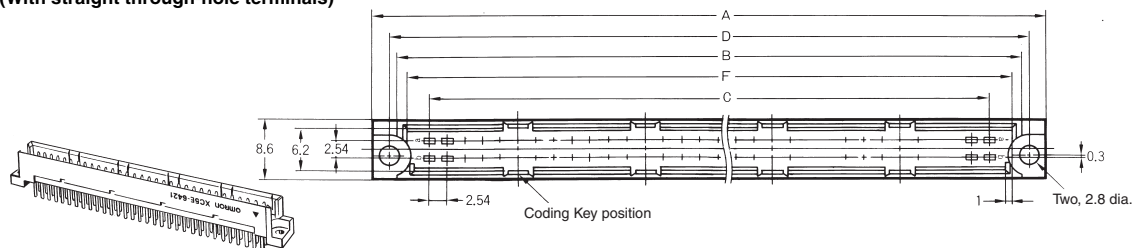

XC5E-□□23

(With straight wrap terminals)

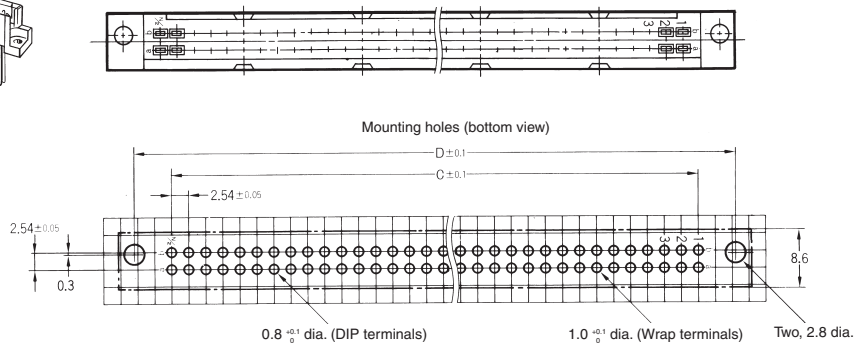
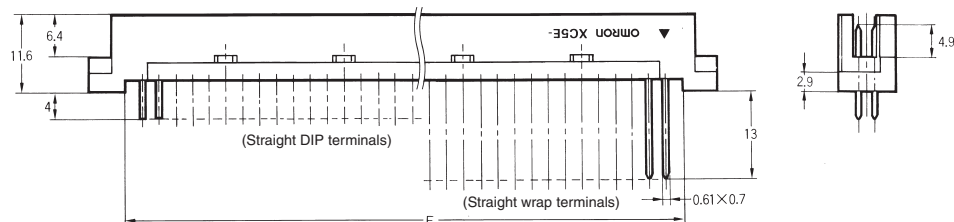
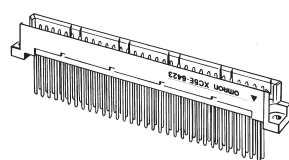

No. of contacts	Dimensions (mm)						Coding Key positions (contact No.)
	A	B	C	D	E	F	
20	38.9	32.1	22.86	34.12	28.1	29.3	3, 8
32	54.2	47.4	38.10	49.36	43.3	44.6	5, 12
44	69.4	62.6	53.34	64.60	58.5	59.8	4, 9, 14, 19
50	77.0	70.2	60.96	72.22	66.2	67.4	5, 10, 16, 21
64	94.8	88.0	78.74	90.00	83.9	85.2	6, 13, 20, 27
100	140.5	133.7	124.46	135.72	129.7	130.9	10, 20, 31, 41

## ■ Ordering Information

No. of contacts	Terminal type	
	Straight through-hole terminals	Straight wrap terminals
20*	XC5E-2021	XC5E-2023
32	XC5E-3221	XC5E-3223
44*	XC5E-4421	XC5E-4423
50*	XC5E-5021	XC5E-5023
64	XC5E-6421	XC5E-6423
100*	XC5E-0121	XC5E-0123

\*Marked items have an increased number of contacts while following DIN standards.

# XC5F Double-row Sockets, DIN Q-type (Reverse)

## ■ Dimensions

XC5F-□□22

(With right-angle through-hole terminals)

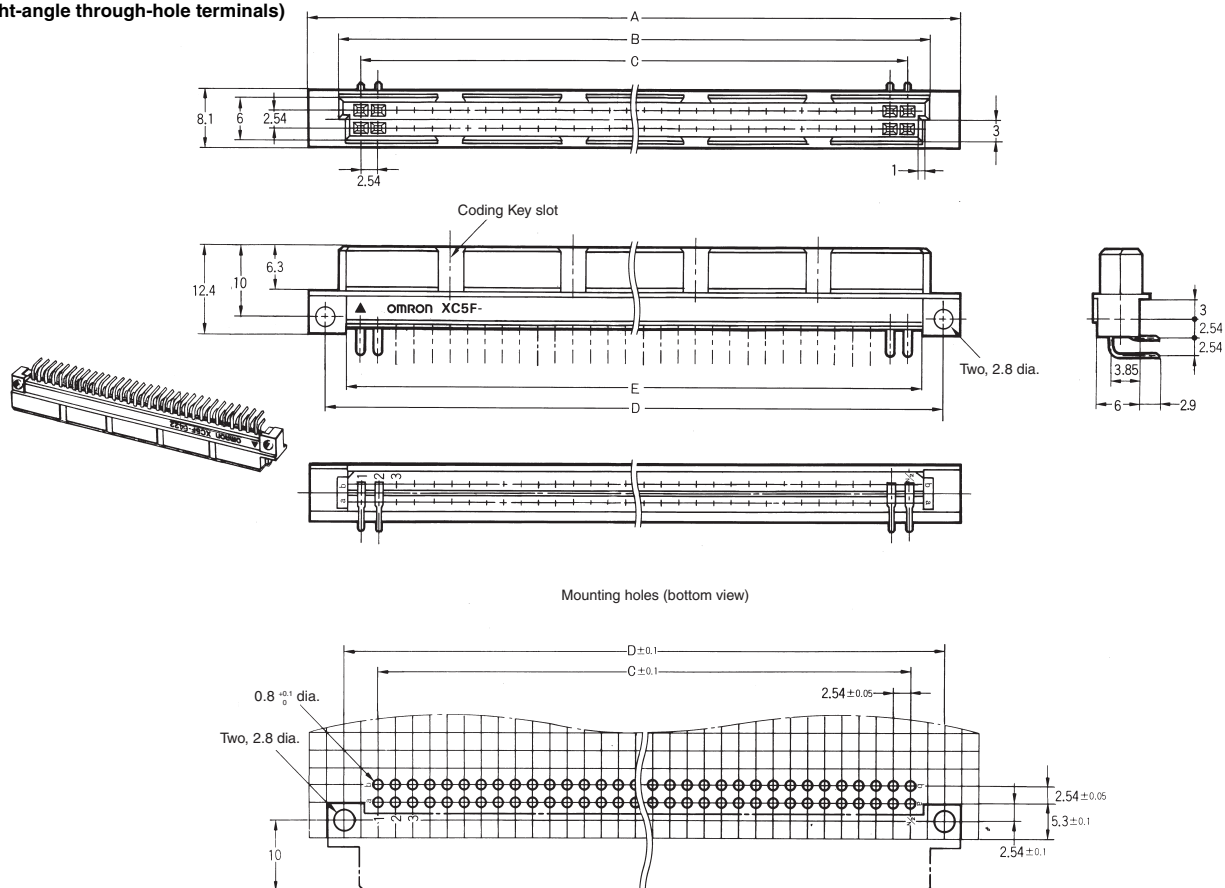

No. of contacts	Dimensions (mm)					Coding Key slot positions (contact No.)
	A	B	C	D	E	
20*	37.9	29.1	22.86	33.02	27.1	3, 8
32	53.2	44.4	38.10	48.26	42.3	5, 12
44*	68.4	59.6	53.34	63.50	57.5	4, 9, 14, 19
50*	76.0	67.2	60.96	71.12	65.2	5, 10, 16, 21
64	93.8	85.0	78.74	88.90	82.9	6, 13, 20, 27
100*	139.5	130.7	124.46	134.62	128.7	10, 20, 31, 41

## ■ Ordering Information

No. of contacts	Terminal type	Model
20*	Right-angle through-hole terminals	XC5F-2022
32		XC5F-3222
44*		XC5F-4422
50*		XC5F-5022
64		XC5F-6422
100*		XC5F-0122

\*Marked items have an increased number of contacts while following DIN standards.

# XC5C Triple-row Plugs, DIN C-type (Standard)

## ■ Dimensions

XC5C-□□22

(With right-angle through-hole terminals)

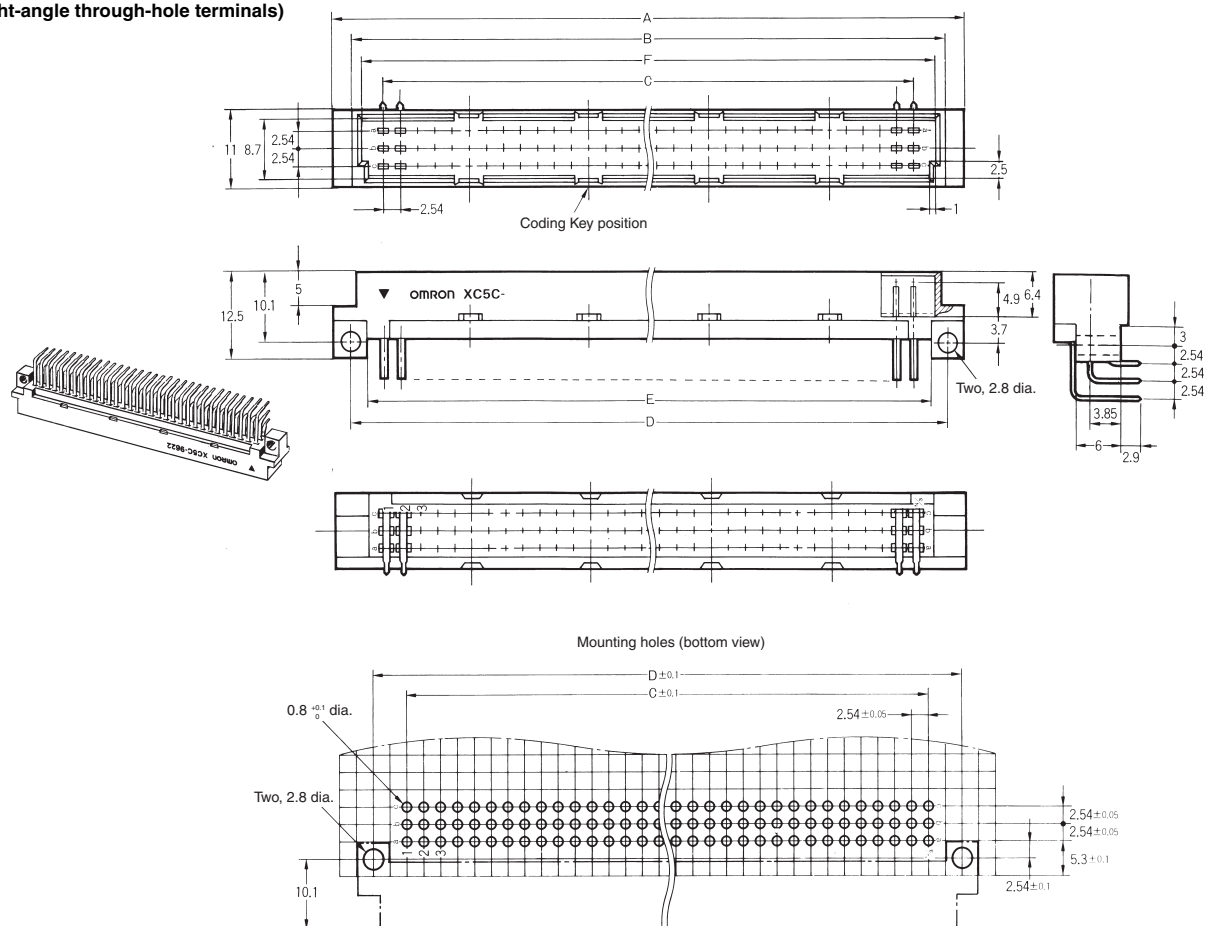

No. of contacts	Dimensions (mm)						Coding Key positions (contact No.)
	A	B	C	D	E	F	
32*	53.2	47.4	38.10	48.26	43.3	44.6	5, 12
48	53.2	47.4	38.10	48.26	43.3	44.6	5, 12
64*	93.8	88.0	78.74	88.90	83.9	85.2	6, 13, 20, 27
96	93.8	88.0	78.74	88.90	83.9	85.2	6, 13, 20, 27

\*Has no center row (row b).

## ■ Ordering Information

No. of contacts	Terminal type	Model
32*	Right-angle through-hole terminals	XC5C-3222
48		XC5C-4822
64*		XC5C-6422
96		XC5C-9622

\*Has no center row (row b).

# XC5D Triple-row Sockets, DIN C-type (Standard)

## ■ Dimensions

### XC5D-□□21

(With straight through-hole terminals)

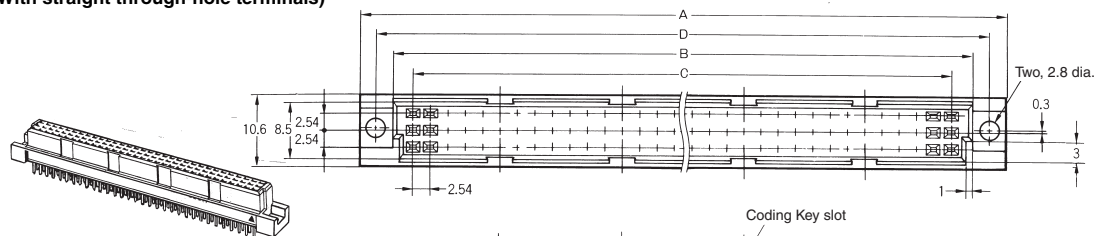

### XC5D-□□23

(With straight wrap terminals)

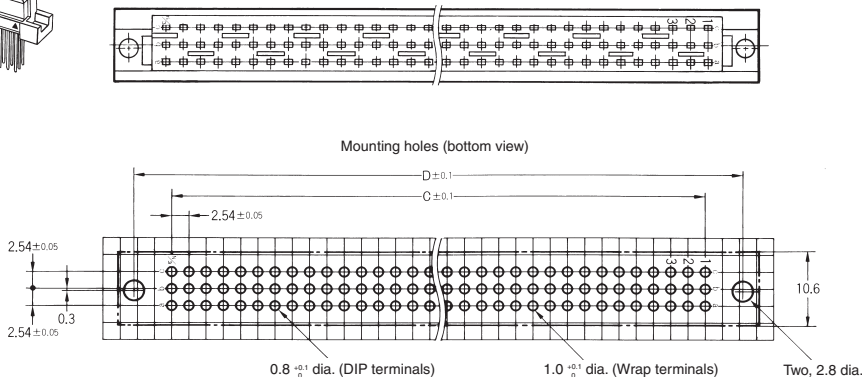
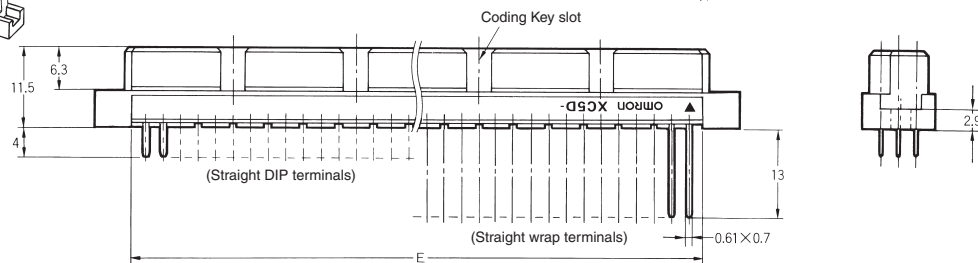
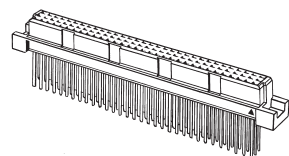

No. of contacts	Dimensions (mm)					Coding Key slot positions (contact No.)
	A	B	C	D	E	
32*	54.2	44.4	38.10	49.36	42.3	5, 12
48	54.2	44.4	38.10	49.36	42.3	5, 12
64*	94.8	85.0	78.74	90.00	82.9	6, 13, 20, 27
96	94.8	85.0	78.74	90.00	82.9	6, 13, 20, 27

\*Has no center row (row b).

## ■ Ordering Information

No. of contacts	Terminal type	
	Straight through-hole terminals	Straight wrap terminals
32*	XC5D-3221	---
48	XC5D-4821	XC5D-4823
64*	XC5D-6421	XC5D-6423
96	XC5D-9621	XC5D-9623

\*Has no center row (row b).

# XC5G Triple-row Plugs, DIN R-type (Reverse)

## ■ Dimensions

XC5G-□□21

(With straight through-hole terminals)

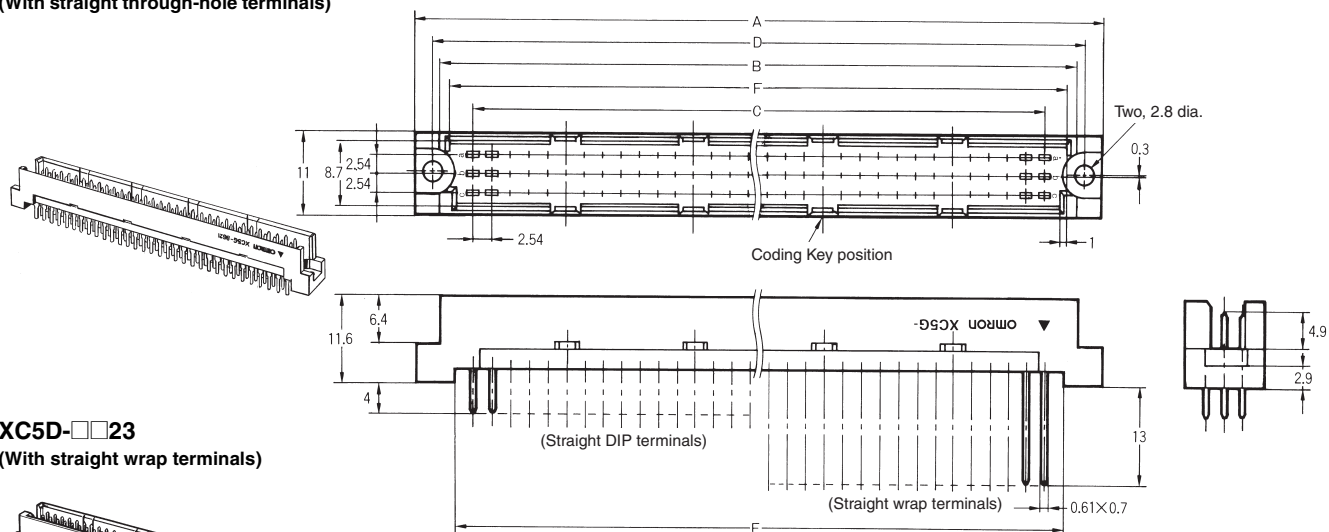

XC5D-□□23

(With straight wrap terminals)

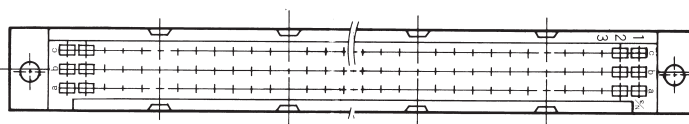
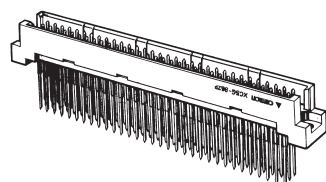

Mounting holes (bottom view)

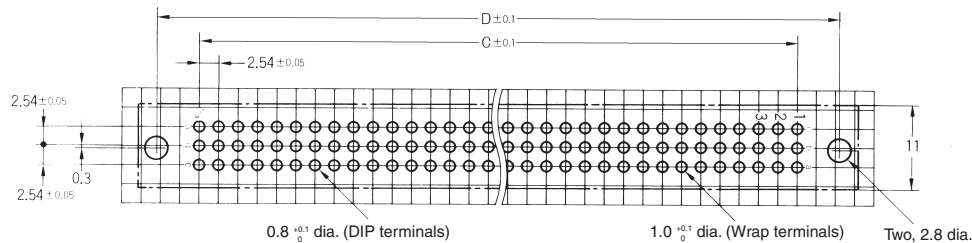

No. of contacts	Dimensions (mm)						Coding Key positions (contact No.)
	A	B	C	D	E	F	
48	54.2	47.4	38.10	49.36	43.3	44.6	5, 12
64*	94.8	88.0	78.74	90.00	83.9	85.2	6, 13, 20, 27
96	94.8	88.0	78.74	90.00	83.9	85.2	6, 13, 20, 27

\*Has no center row (row b).

## ■ Ordering Information

No. of contacts	Terminal type	
	Straight through-hole terminals	Straight wrap terminals
48	XC5G-4821	XC5G-4823
64*	XC5G-6421	XC5G-6423
96	XC5G-9621	XC5G-9623

\*Has no center row (row b).



# XC5H Triple-row Sockets, DIN R-type (Reverse)

## ■ Dimensions

XC5H-□□22

(With right-angle through-hole terminals)

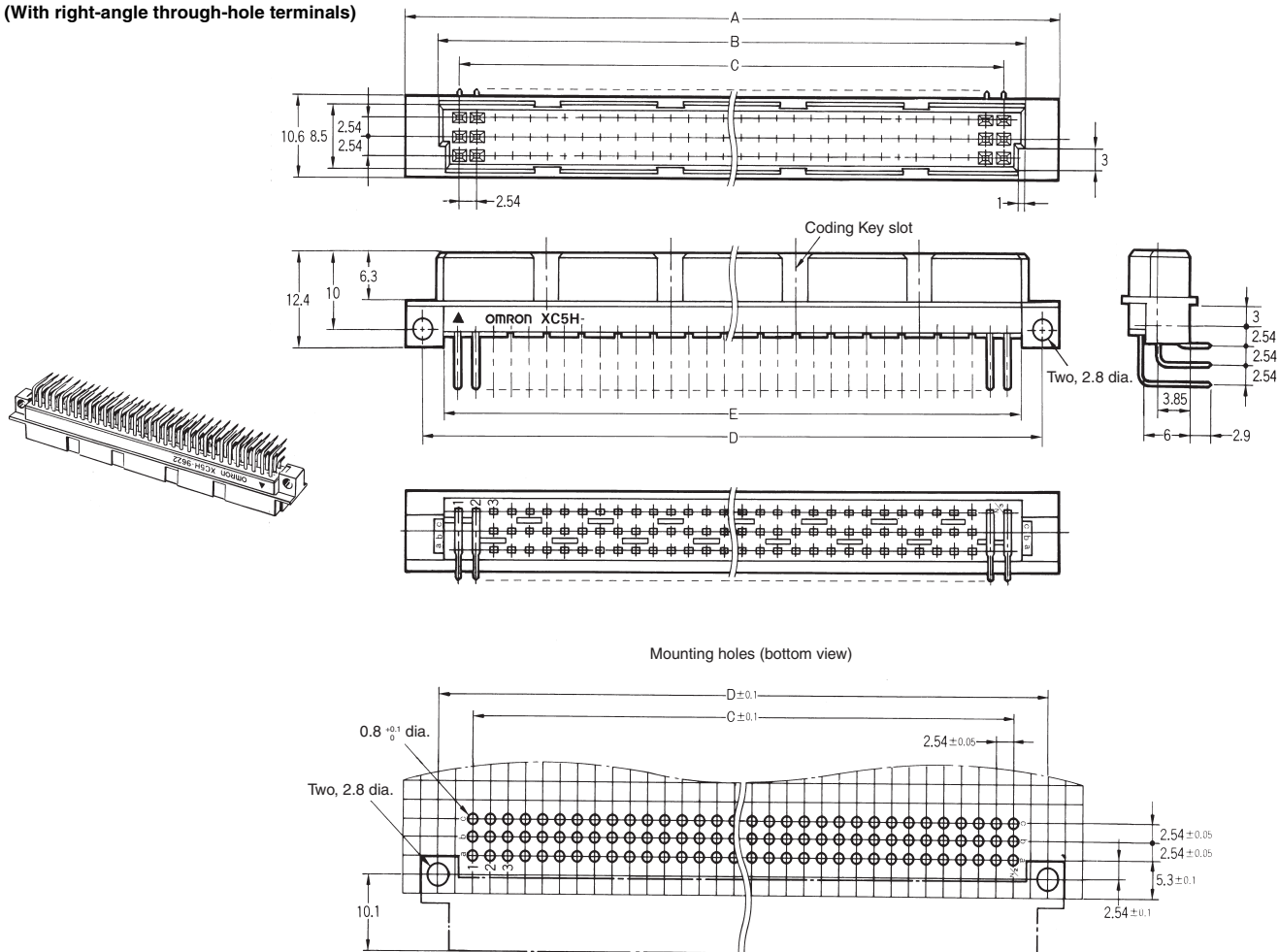

No. of contacts	Dimensions (mm)					Coding Key slot positions (contact No.)
	A	B	C	D	E	
48	53.2	44.4	38.10	48.26	42.3	5, 12
64*	93.8	85.0	78.74	88.90	82.9	6, 13, 20, 27
96	93.8	85.0	78.74	88.90	82.9	6, 13, 20, 27

\*Has no center row (row b).

## ■ Ordering Information

No. of contacts	Terminal type	Model
48	Right-angle through-hole terminals	XC5H-4822
64*		XC5H-6422
96		XC5H-9622

\*Has no center row (row b).

# Tools and Accessories (Sold Separately)

## Coding Cutter XY2D-0001

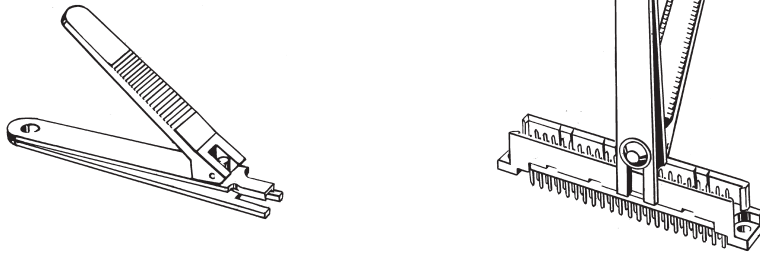

Cut the Coding Key on the Plug and insert the Coding Key in the Coding Key slots on the Socket to prevent improper insertion of the Plug into the Socket.

1. Cut the Coding Key(s) in the slot in the plug housing wall with the special cutting tool (XY2D-0001).

**Note:** Coding Cutters may not work with some DIN-style connector combinations. In that case, contact your OMRON representative.

## Coding Key XC5Z-0001

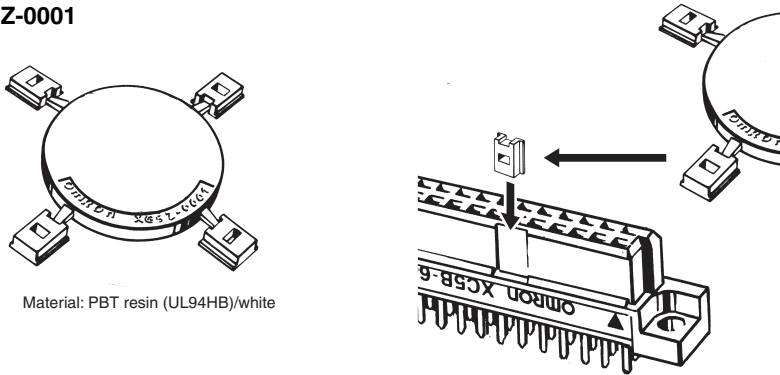

Material: PBT resin (UL94HB)/white

2. Insert the special Coding Key (XC5Z-0001) into the Coding Key slots in the housing wall of the corresponding Socket.

**Note:** 1. Each XC5Z-0001 has four Coding Keys.

2. Coding Keys may not work with some DIN-style connector combinations. In that case, contact your OMRON representative.

## Temporary Fastening Pins XC5Z-0002

(For use with 1.6-mm boards)

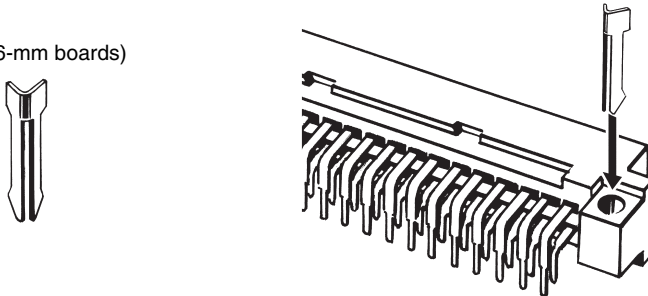

Fastening pins (XC5Z-0002) are used to keep the connector flush against the board during automated soldering.

**Note:** 1. For the XC5A, XC5F, XC5C, and XC5H.

2. Temporary fastening pins cannot be used with DIN-style connectors.

## Dust Cover XC5T-962

(For DIN41612 C- or R-type Triple-row Plugs with 64 or 96 contacts)

## XC5T-963

(For DIN41612 C- or R-type Triple-row Sockets with 64 or 96 contacts)

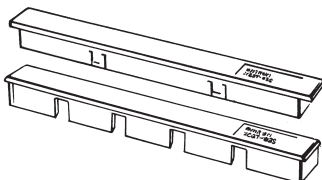

Material: Polyamide resin (UL94V-2)/white

This cover is for protection against dust only, and should not be used for flux protection during automated soldering.

# Mating Diagrams

	Vertical (Standard)	Vertical (Reverse)	Stacking (See note.)	Horizontal (See note.)
<b>Double-row Connectors</b>				
<b>Triple-row Connectors</b>				

**Note:** By combining a Standard and a Reverse Connector, stacking and horizontal connections can be made. In this case, the triangular marks (terminal number 1) on the Plug and the Socket will not match.

# Precautions

## ■ Correct Use

### Basic Mating Dimensions

Mating dimensions for all Connectors should be as shown in the following diagram.

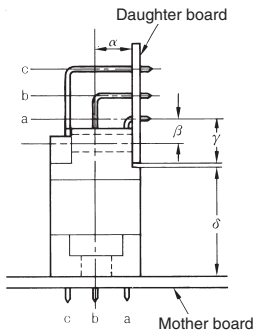

**α: 3.55 mm**

The distance between the center line of the mounting holes on the mother board and the daughter board. (This center line is shifted 0.3 mm toward row a from row b.)

**β: 2.54 mm**

The distance between the mounting holes on the daughter board and row a.

**γ: 5.3 mm**

The distance between the edge of the daughter board and row a.

**δ: 12.4 to 14.2 mm**

To ensure reliability, be sure to keep the Connectors within these dimensions when mounting.

The allowable margins for mating the Connectors are shown below.

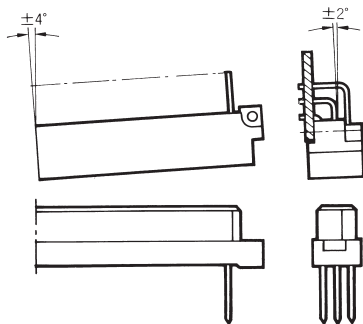
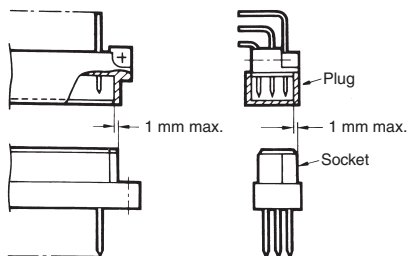

### Applicable Wrap Post Wire Sizes

AWG30, AWG28, AWG26, or AWG24  
(Solid wire: 0.25 to 0.51 mm dia.)

### Wrap Post Length

3 wires

### Soldering

#### Automated Soldering

Use masking tape to mask Right-angle Connectors before automated soldering.

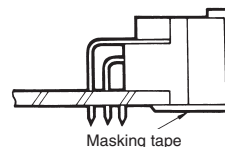

(Recommended tape: 3M Sumitomo #214)

#### Automated Soldering Conditions (Jet Flow)

1. Soldering temperature: 250±5°C
2. Continuous soldering time: Within 5 s



All sales are subject to Omron Electronic Components LLC standard terms and conditions of sale, which can be found at [http://www.components.omron.com/components/web/webfiles.nsf/sales\\_terms.html](http://www.components.omron.com/components/web/webfiles.nsf/sales_terms.html)

**ALL DIMENSIONS SHOWN ARE IN MILLIMETERS.**  
To convert millimeters into inches, multiply by 0.03937. To convert grams into ounces, multiply by 0.03527.

---

**OMRON**<sup>®</sup>

**OMRON ELECTRONIC  
COMPONENTS LLC**

55 E. Commerce Drive, Suite B  
Schaumburg, IL 60173

**847-882-2288**

**OMRON ON-LINE**

Global - <http://www.omron.com>

USA - <http://www.components.omron.com>