

V/VX/D3V Common Accessories











Ordering Information

■ Actuators (Sold Separately)

Actuators are supplementary components used when operating pin plunger switches using cams or dogs or when transmitting mechanical movements that are not in alignment with the switch plunger. Three series of actuators are optionally available: VAL, VAM and VAV series.

1. The VAL series are designated for operation by rotary cam or sliding devices.
2. The VAM series actuators designed are operate in reverse movement and are highly resistive to vibration and shock. The large OT of these models make them ideal for machine tools and automatic doors where the switches are subject to heavy vibration or shock.
3. The VAV series actuators are highly sensitive to force. Therefore, they should be used in applications where the operating force to be applied to the switch is very low.

Common to Miniature Basic Models (V, VX and D3V)

Actuator	Series	Common to Miniature, V-Size models
Leaf Spring 	VAL	VAL
Simulated Roller Leaf Spring 		VAL12
Roller Leaf Spring 		VAL2, VAL02
Reverse Long Hinge 	VAM	VAM
Reverse Hinge 		VAM21
Reverse Roller Modified 		VAM-1
Reverse Hinge Roller 		VAM22
Reverse Long Hinge Roller 		VAM2
Long Hinge 	VAV	VAV
Hinge Wire 		VAV-5
Hinge Roller 		VAV2

- Note:**
1. These actuators do not include switches
 2. Pin plunger versions of Omron's miniature basic snap-action switches, with the mounting hole locations shown below, can be used with the actuators (except for special models).

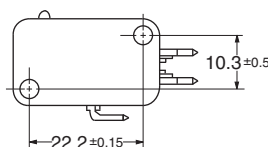

Dimensions

- Note:**
1. Unless otherwise specified, all units are in millimeters and a tolerance of ± 0.4 mm applies to all dimensions
 2. The operating characteristics below apply when the actuator is attached to V-15-1A5-K basic switch. (Except the VAV-5, which applies when VX-5-1A2 is attached.) Consult Omron for operating characteristics of models not listed in the following tables.
 3. Model numbers are for the actuator only. These actuators do not include the switch.
 4. The operating characteristics are for operation in the A direction (\downarrow).

VAL Series

Leaf Spring

VAL (Designed for models of OF 200 gf and greater)

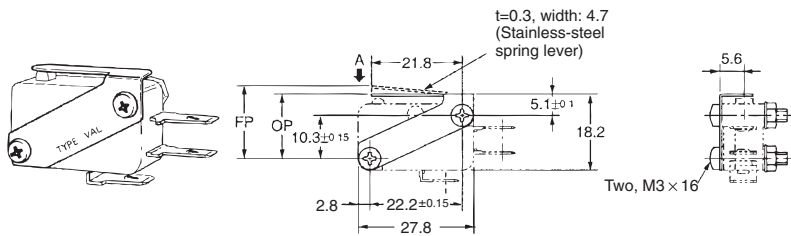

Characteristics when used with V-15-1A5	
OF max.	230 gf
RF min.	50 gf
OT min.	0.8 mm
MD max.	0.4 mm
FP max.	17 mm
OP	14.9 ± 0.5 mm

Simulated Roller Leaf Spring

VAL12 (Designed for models of OF 200 gf and greater)

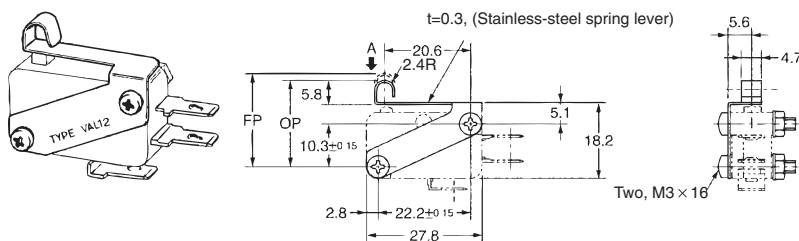

Characteristics when used with V-15-1A5	
OF max.	230 gf
RF min.	50 gf
OT min.	0.8 mm
MD max.	0.4 mm
FP max.	22.9 mm
OP	20.5 ± 0.8 mm

Roller Leaf Spring

VAL2, VAL02 (Designed for models of OF 200 gf max.)

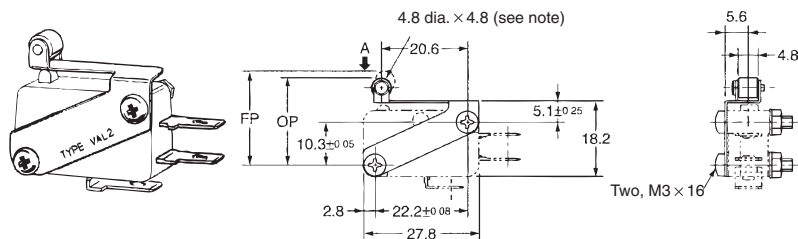

Characteristics when used with V-15-1A5	
OF max.	230 gf
RF min.	50 gf
OT min.	0.8 mm
MD max.	0.4 mm
FP max.	22.6 mm
OP	20.5 ± 0.5 mm

Note: VAL2: Unlubricated polyacetal resin roller
VAL02: Stainless-steel roller

VAM Series

Reverse Long Hinge Lever

VAM

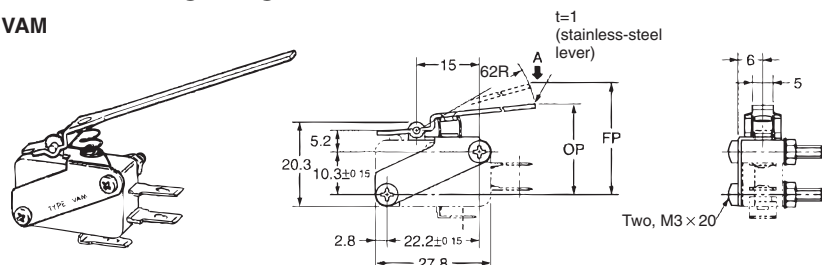

Characteristics when used with V-15-1A5	
OF max.	200 gf
RF min.	30 gf
OT min.	7 mm (reference value)
MD max.	5 mm
FP max.	45 mm
OP	20 ± 9 mm

- Note:** 1. Unless otherwise specified, all units are in millimeters and a tolerance of ± 0.4 mm applies to all dimensions
 2. The operating characteristics below apply when the actuator is attached to V-15-1A5-K basic switch. (Except the VAV-5, which applies when VX-5-1A2 is attached.) Consult Omron for operating characteristics of models not listed in the following tables.
 3. Model numbers are for the actuator only. These actuators do not include the switch.
 4. The operating characteristics are for operation in the A direction (\blacktriangledown).

Reverse Hinge Lever

VAM21

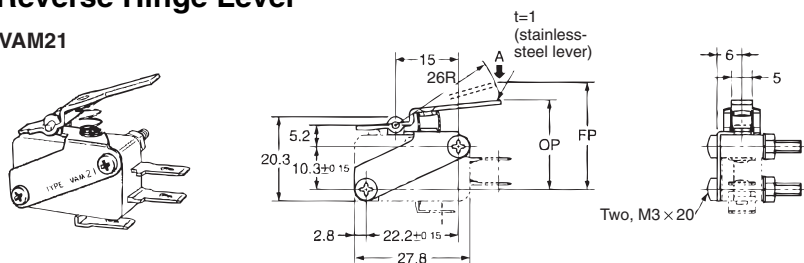

Characteristics when used with V-15-1A5	
OF max.	360 gf
RF min.	70 gf
OT min.	5 mm (reference value)
MD max.	4 mm
FP max.	30 mm
OP	20 ± 4 mm

Reverse Roller Modified Lever

VAM-1

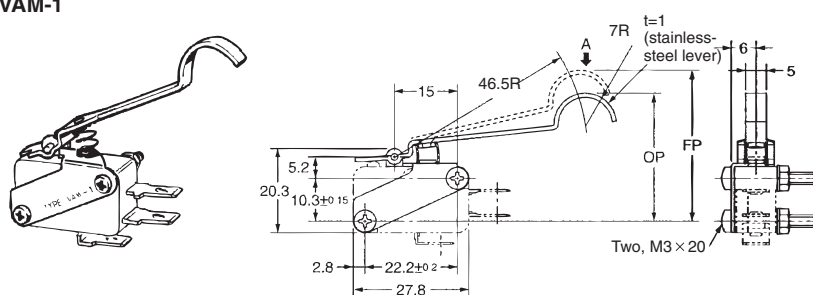

Characteristics when used with V-15-1A5	
OF max.	300 gf
RF min.	40 gf
OT min.	5 mm (reference value)
MD max.	6 mm
FP max.	47 mm
OP	30 ± 5 mm

Reverse Hinge Roller Lever

VAM22

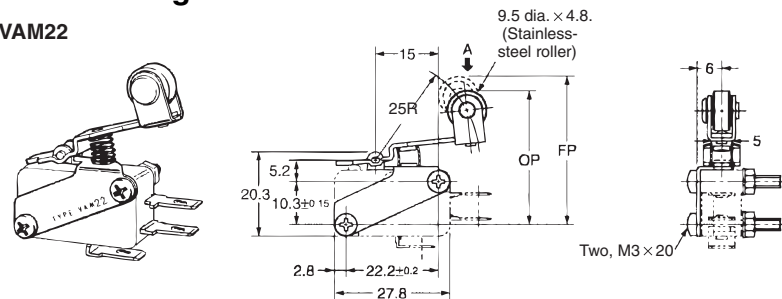

Characteristics when used with V-15-1A5	
OF max.	360 gf
RF min.	70 gf
OT min.	3 mm (reference value)
MD max.	4 mm
FP max.	38 mm
OP	31.3 ± 3 mm

Reverse Long Hinge Roller Lever

VAM2

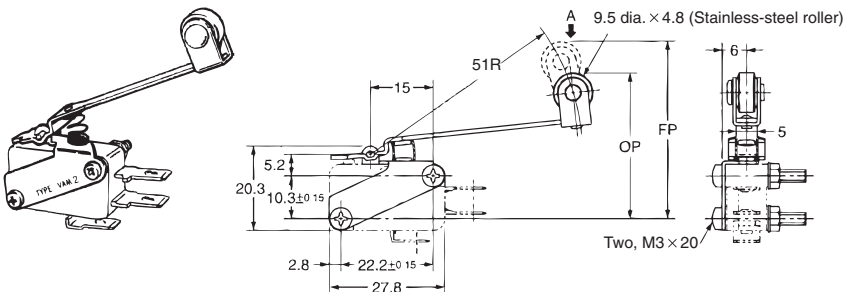

Characteristics when used with V-15-1A5	
OF max.	250 gf
RF min.	40 gf
OT min.	7 mm (reference value)
MD max.	6 mm
FP max.	48 mm
OP	31 ± 6 mm

- Note:** 1. Unless otherwise specified, all units are in millimeters and a tolerance of ± 0.4 mm applies to all dimensions
 2. The operating characteristics below apply when the actuator is attached to V-15-1A5-K basic switch. (Except the VAV-5, which applies when VX-5-1A2 is attached.) Consult Omron for operating characteristics of models not listed in the following tables.
 3. Model numbers are for the actuator only. These actuators do not include the switch.
 4. The operating characteristics are for operation in the A direction (\downarrow).

VAV Series

Long Hinge Lever

VAV

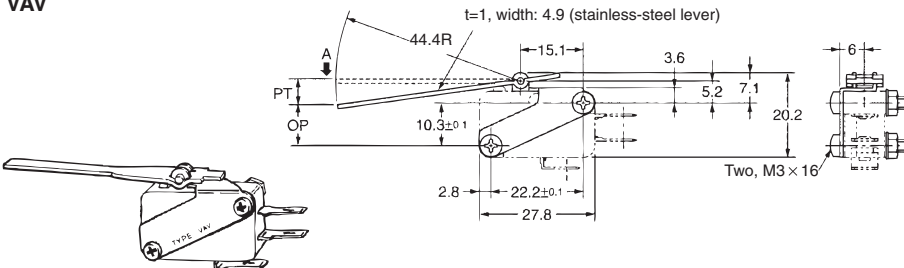

Characteristics when used with V-15-1A5	
OF max.	35 gf
RF min.	4 gf
OT min.	7.6 mm
MD max.	3.6 mm
FP max.	4.7 mm
OP	Approx 10.6 mm

Hinge Wire Lever

VAV-5 (Designed for models of OF 25 gf max.)

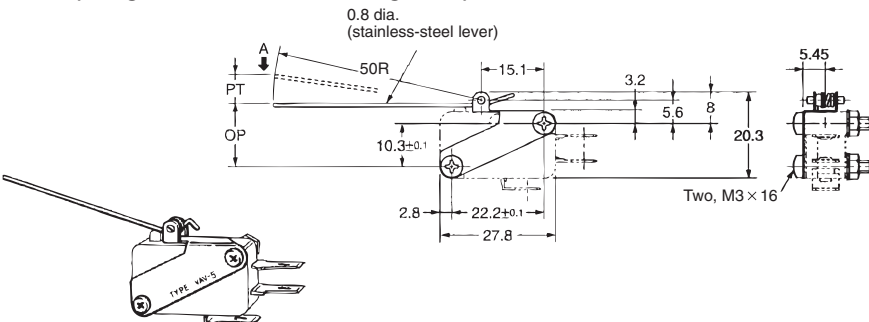

Characteristics when used with VX-5-1A2	
OF max.	2.8 gf
RF min.	0.2 gf
OT min.	16 mm
MD max.	2 mm
FP max.	5 mm
OP	Approx 16.7 mm

Hinge Roller Lever

VAV2

4.8 dia. x 4.8 (Unlubricated polyacetal resin roller)

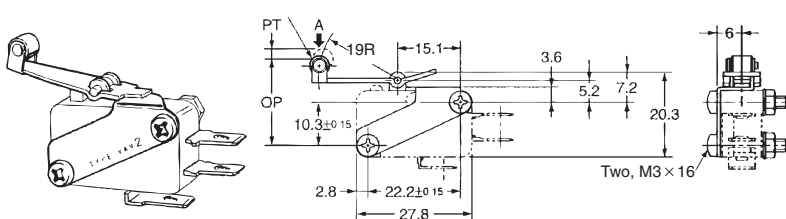

Characteristics when used with V-15-1A5	
OF max.	75 gf
RF min.	9 gf
OT min.	4.8 mm
MD max.	1.5 mm
FP max.	1.2 mm
OP	18.6 ± 1.6 mm

A large grid of graph paper for taking notes, consisting of 20 columns and 30 rows of small squares.

All sales are subject to Omron Electronic Components LLC standard terms and conditions of sale, which can be found at http://www.components.omron.com/components/web/webfiles.nsf/sales_terms.html

ALL DIMENSIONS SHOWN ARE IN MILLIMETERS.
To convert millimeters into inches, multiply by 0.03937. To convert grams into ounces, multiply by 0.03527.

OMRON[®]

**OMRON ELECTRONIC
COMPONENTS LLC**

55 E. Commerce Drive, Suite B
Schaumburg, IL 60173

847-882-2288

OMRON ON-LINE

Global - <http://www.omron.com>

USA - <http://www.components.omron.com>