

# General Purpose Relay G7L

- Ideally suited for high-inrush fluid pump controls: pool/spa, water processing, emergency, chemical industry, etc.
- High-capacity, high-withstand voltage relay with no contact chattering for momentary voltage drops up to 50% of rated voltage.
- UL Class B construction standard.
- Wide-range AC-activated coil that handles 100 to 120 VAC or 200 to 240 VAC at either 50 or 60 Hz.
- Miniature size for maximum switching capacity, particularly for inductive loads.
- Flame resistant materials (UL94V-0-qualifying) used for all insulation material.
- Quick-connect, screw, PCB terminals and DIN track mounting available.
- Conforms to UL, CSA, TUV and meets IEC 950.
- Safety design with contact gap of 3 mm.
- RoHS Compliant.

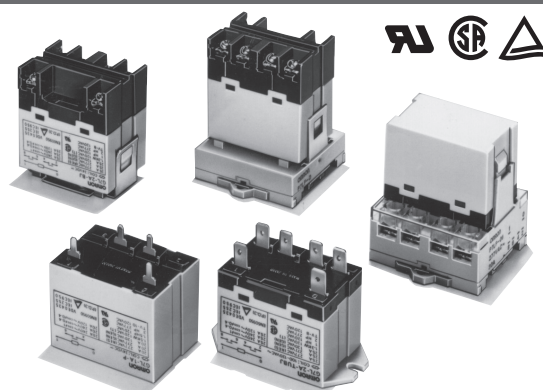

Note: Accessories: E-bracket, Adapter, Front-connecting socket and Cover are sold separately.

## Ordering Information

To Order: Select the part number and add the desired coil voltage rating (e.g., G7L-1A-T-CB-AC100/120).

Type	Contact form	Model		
		Quick-connect terminal	Screw terminal	PCB terminal
E bracket (see note 1)	SPST-NO	G7L-1A-T-CB	G7L-1A-B-CB	—
	DPST-NO	G7L-2A-T-CB	G7L-2A-B-CB	—
E bracket (see note 1) (with test button)	SPST-NO	G7L-1A-TJ-CB	G7L-1A-BJ-CB	—
	DPST-NO	G7L-2A-TJ-CB	G7L-2A-BJ-CB	—
Upper bracket	SPST-NO	G7L-1A-TUB-CB	G7L-1A-BUB-CB	—
	DPST-NO	G7L-2A-TUB-CB	G7L-2A-BUB-CB	—
Upper bracket (with test button)	SPST-NO	G7L-1A-TUBJ-CB	G7L-1A-BUBJ-CB	—
	DPST-NO	G7L-2A-TUBJ-CB	G7L-2A-BUBJ-CB	—
PCB mounting	SPST-NO	—	—	G7L-1A-P-CB
	DPST-NO	—	—	G7L-2A-P-CB

- Note: 1. E bracket or socket must be used for mounting (part number R99-07G7L). Refer to “Accessories” section for options and part numbers.  
2. For VDE approved versions, please consult OMRON.

## List of E-Bracket Mounting Models

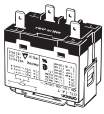
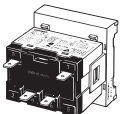
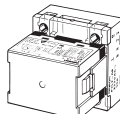
				Mounting	E-brackets	DIN Track Mounting Adapter	Front-connecting Socket
Terminal	Contact form	Model	Test button				
Quick-connect terminals	SPST-NO	G7L-1A-T	-	<input type="checkbox"/>	<input type="checkbox"/>	<input type="checkbox"/>	<input type="checkbox"/>
		G7L-1A-TJ	With test button	<input type="checkbox"/>	<input type="checkbox"/>	<input type="checkbox"/>	<input type="checkbox"/>
	DPST-NO	G7L-2A-T	-	<input type="checkbox"/>	<input type="checkbox"/>	<input type="checkbox"/>	<input type="checkbox"/>
		G7L-2A-TJ	With test button	<input type="checkbox"/>	<input type="checkbox"/>	<input type="checkbox"/>	<input type="checkbox"/>
Screw terminals	SPST-NO	G7L-1A-B	-	<input type="checkbox"/>	<input type="checkbox"/>	—	—
		G7L-1A-BJ	With test button	<input type="checkbox"/>	<input type="checkbox"/>	—	—
	DPST-NO	G7L-2A-B	-	<input type="checkbox"/>	<input type="checkbox"/>	—	—
		G7L-2A-BJ	With test button	<input type="checkbox"/>	<input type="checkbox"/>	—	—

Note: Accessories: E-bracket (R99-07), Adapter (P7LF-D), Front-connecting socket (P7LF-06) and Cover (P7LF-C) are sold separately.

## Model Number Legend

G7L-□ - □ □ □ - □ - □ - □  
1 2 3 4 5 6 7

- |  |   |   |
|--|---|---|
| <p><b>1. Contact form</b><br/>1A:SPST-NO<br/>2A:DPST-NO</p>  | <p><b>3. Mounting construction</b><br/>No symbol:E bracket type<br/>UB:Upper bracket type</p> | <p><b>5. 80: VDE approved version</b><br/>(includes UL, CSA and TÜV)</p>    |
| <p><b>2. Terminal shape</b><br/>T:Quick-connect terminals (#250)<br/>P:PCB terminals<br/>B:Screw terminals</p> | <p><b>4. Special functions</b><br/>No symbol:Without test button<br/>J:With test button</p>   | <p><b>6. CB: Class B insulation</b></p> <p><b>7. Rated coil voltage</b></p> |

## Accessories (Sold Separately)

### Quick-connect Terminals

Description	Model				Model
	Contact form				
	SPST-NO		DPST-NO		
E-brackets	G7L-1A-T	G7L-1A-TJ	G7L-2A-T	G7L-2A-TJ	R99-07G7L
Track mounting adapter					P7LF-D
Front connecting socket					P7LF-06

**Note:** A socket terminal cover is supplied with the P7LF-06 socket and does not attach directly to the G7L relays. It cannot be purchased separately.

### Screw Terminals

Description	Model				Model
	Contact form				
	SPST-NO		DPST-NO		
E-brackets	G7L-1A-B	G7L-1A-BJ	G7L-2A-B	G7L-2A-BJ	R99-07G7L
Track mounting adapter					P7LF-D
Terminal Cover					P7LF-C

**Note:** The P7LF-C terminal cover attaches directly to the G7L-B style relays. It is sold separately.

## Specifications

### Contact Data

Load	G7L-1A-T□, G7L-1A-B□		G7L-2A-T□, G7L-2A-B□		G7L-1A-P, G7L-2A-P	
	Resistive load (cosφ = 1)	Inductive load (cosφ = 0.4)	Resistive load (cosφ = 1)	Inductive load (cosφ = 0.4)	Resistive load (cosφ = 1)	Inductive load (cosφ = 0.4)
Rated load	30 A, 220 VAC	25 A, 220 VAC			20 A, 220 VAC	
Contact Type	Double break					
Contact material	Ag alloy					
Carry current	30 A		25 A		20 A	
Max. operating voltage	250 VAC					
Max. operating current	30 A		25 A		20 A	
Max. switching capacity	6,600 VA	5,500 VA			4,400 VA	
Min. permissible load	100 mA, 5 VDC (@ 60 operations / minute). Note: Do not use for switching microloads, such as signals.					

**Note:** 1. P level:  $\lambda_{60} = 0.1 \times 10^{-6}$  operation.  
2. When using B-series (screw) products, since the screw diameter of the contact terminal is M4, be careful that the contact current should be 20 A or less according to JET standard (electrical appliance and material control law of Japan).

### Coil Internal Circuit

DC operating coil

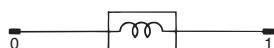

AC operating coil

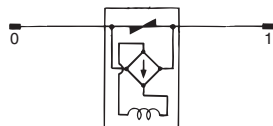

- Note:**
- The ratio of rated voltage between 100 to 120 VAC are values measured on the basis of 100 VAC
  - When driving a transistor, check the leakage current and connect a bleeder resistor if necessary.
  - The AC coil is provided with a built-in full-wave rectifier. If a triac, such as an SSR, drives the G7L, the G7L may not release. Be sure to perform a trial operation with the G7L and the triac before applying them to actual use.

## ■ Coil Data

### AC

Rated voltage (V)	Rated current (mA)	Resistance (Ω)	Must operate	Must release	Max. voltage	Power consumption
			% of rated voltage			
12	142	75	75% max.	15% min.	110% max.	Approx. 1.70 to 2.50 VA
24	71	303				
50	34	1,310				
100 to 120	17.00 to 20.40	5,260	75 volts max.	18 volts min.	132 volts	
200 to 240	8.50 to 10.20	21,000	150 volts max.	36 volts min.	264 volts	

### DC

Rated voltage (V)	Rated current (mA)	Resistance (Ω)	Coil inductance (H)		Must operate	Must release	Max. voltage	Power consumption
			Armature ON	Armature OFF	% of rated voltage			
6	317	18.90	0.9	0.21	75% max.	15% min.	110% max.	Approx. 1.90 W
12	158	75	0.37	0.88				
24	79	303	1.42	3.54				
48	40	1,220	6.1	15.3				
100	19	5,260	21.3	60.0				

- Note:** 1. The rated current and coil resistance are measured at a coil temperature of 23°C with tolerances of +15%/-20% for AC rated current and ±15% for DC coil resistance.  
 2. The inductances shown above are reference values.  
 3. Performance characteristic data are measured at a coil temperature of 23°C.  
 4. The maximum allowable coil voltage refers to the maximum value in a varying range of operating power voltage, measured at ambient temperature 23°C.  
 5. The “to” (for example “100 to 120”) represents a range of rated voltages.

## ■ Characteristics

<b>Contact resistance (note 1)</b>		50 mΩ max.
<b>Operate time (note 2)</b>		30 ms max.
<b>Release time (note 3)</b>		30 ms max.
<b>Max. operating frequency</b>	<b>Mechanical</b>	1,800 operations/hour
	<b>Electrical</b>	1,800 operations/hour (under rated load)
<b>Insulation resistance (note 3)</b>		1,000 MΩ min. (at 500 VDC)
<b>Dielectric strength</b>		4,000 VAC, min., 50/60 Hz for 1 minute between coil and contacts
		2,000 VAC, 50/60 Hz for 1 minute between contacts of same polarity
		2,000 VAC, 50/60 Hz for 1 minute between contacts of different polarity (DPST-NO type)
<b>Impulse withstand voltage</b>		Between coil and contact: 10,000 V - JEC212 (1981) Standard Impulse Wave Type (1.20 x 50 μs)
<b>Vibration</b>	<b>Mechanical durability</b>	10 to 55 Hz; 1.50 mm double amplitude
	<b>Malfunction durability</b>	10 to 55 Hz; 1.50 mm double amplitude
<b>Shock</b>	<b>Mechanical durability</b>	1,000 m/s <sup>2</sup> (approx. 100 G)
	<b>Malfunction durability</b>	100 m/s <sup>2</sup> (approx. 10 G)
<b>Life expectancy</b>	<b>Mechanical</b>	1,000,000 operations min. (at 1,800 operations/hour)
	<b>Electrical @ 23°C</b>	100,000 operations min. (at 1,800 operations/hour under rated load)
<b>Ambient operating temperature</b>		-25° to 60°C (with no icing or condensation)
<b>Ambient operating humidity</b>		5% to 85% RH
<b>Weight</b>	Quick-connect terminal type: approx. 90 g	
	PCB terminal type: approx. 100 g	
	Screw terminal type: approx. 120 g	

**Note:** Data shown are of initial value.

- Note:** 1. Measurement conditions: 5 VDC, 1 A, voltage drop method.  
 2. Measurement conditions: Rated operating voltage applied, not including contact bounce, @ 23°C.  
 3. Measurement conditions: The insulation resistance was measured with a 500-VDC megohmmeter at the same locations as the dielectric strength was measured.

# Engineering Data

## G7L-1A-T (TJ) (TUB) (TUBJ) G7L-1A-B (BJ) (BUB) (BUBJ) Maximum Switching Power

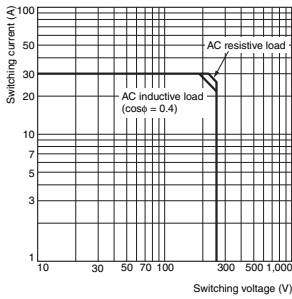

## G7L-2A-T (TJ) (TUB) (TUBJ) G7L-2A-B (BJ) (BUB) (BUBJ) Maximum Switching Power

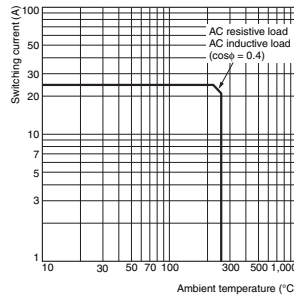

## G7L-1A-P G7L-2A-P Maximum Switching Power

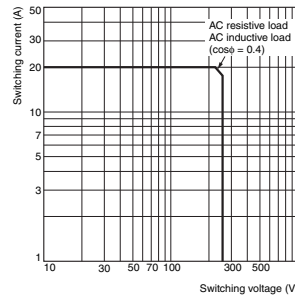

## Ambient Temperature vs. Operate and Release Voltage G7L-1A VAC (60 Hz)

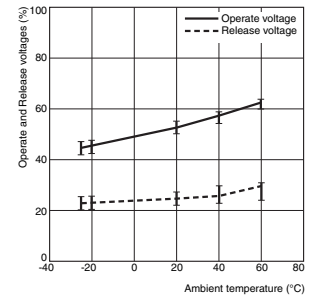

## Endurance

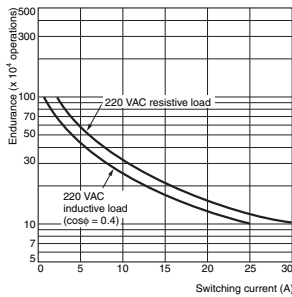

## Endurance

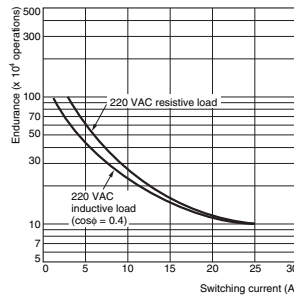

## Endurance

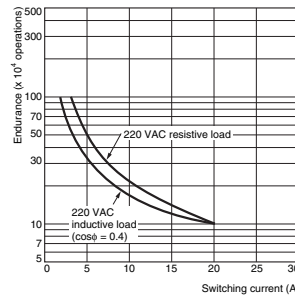

## G7L-1A VDC

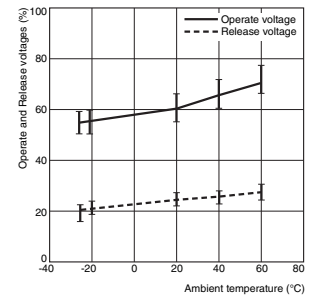

## Ambient Temperature vs. Coil Temperature Rise G7L-1A 120 VAC (50 Hz)

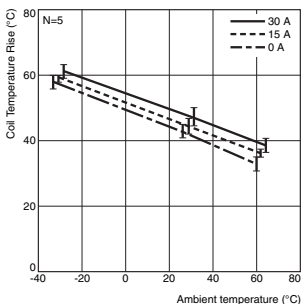

## G7L-1A VDC

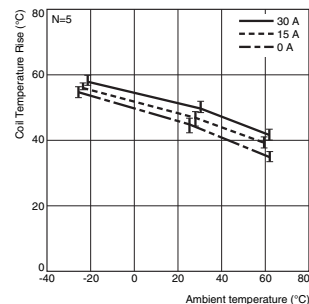

## Shock Malfunction G7L-2A-T (TUB) 100 to 120 VAC

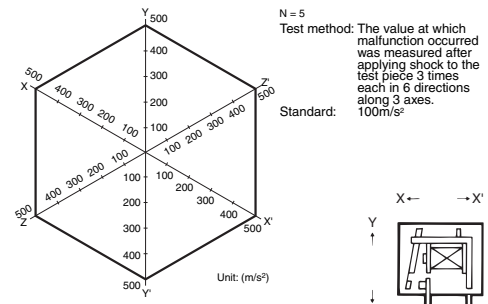

## Momentary Voltage Drop Test G7L-2A-T (TUB) 100 to 120 VAC Test Circuit

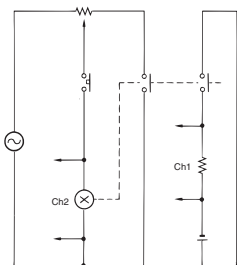

## Wave resulted from test

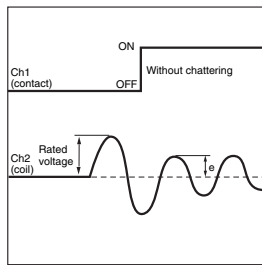

## Voltage distribution of wave e which chattering does not occur.

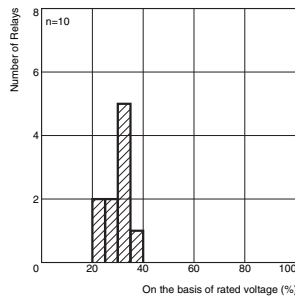

**Characteristic variation resulted from different mounting directions**

**G7L-2A-T (TUB) 100 to 120 VAC**

**Operate time**

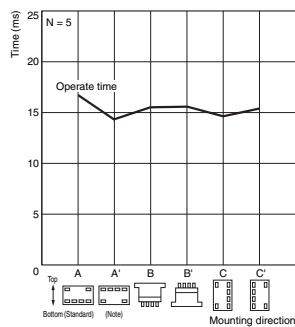

**Release time**

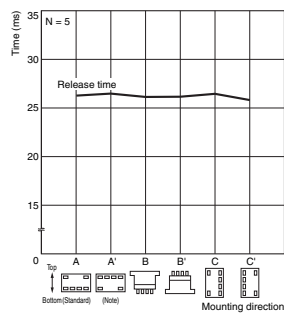

**Operate voltage**

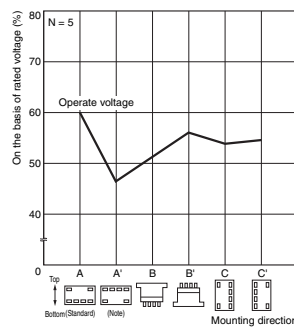

**Release voltage**

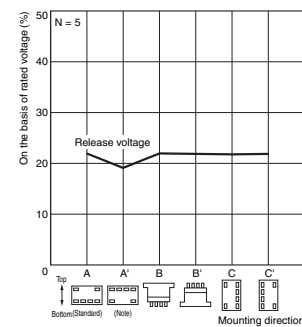

**Note:** The mounting direction A' deteriorates switching performance.

**Actual Load Endurance Test**

**G7L-2A 100 to 200 VAC**

**Operate and Release voltages**

**N = 5**

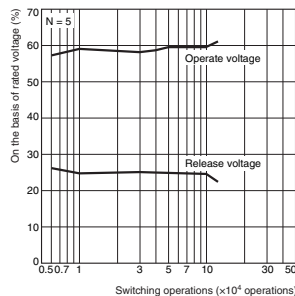

**Contact resistance**

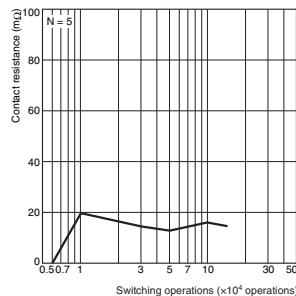

**Operate and Release voltages**

**N = 5**

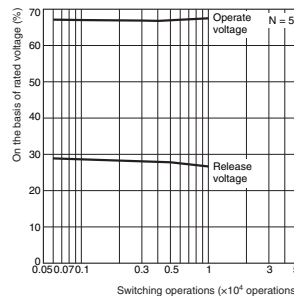

**Contact resistance**

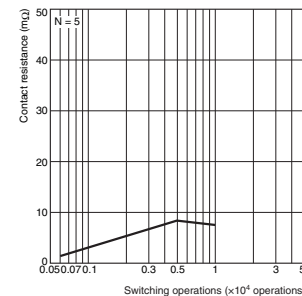

**Load conditions**

**• 1 φ 220 VAC**

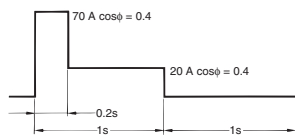

• Applied coil voltage: 100% of rated voltage

**Load conditions**

**• 1 φ 220 VAC**

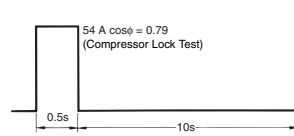

• Applied coil voltage: 100% of rated voltage

**G7L-2A 100 to 200 VAC**

**Operate and Release voltages**

**N = 5**

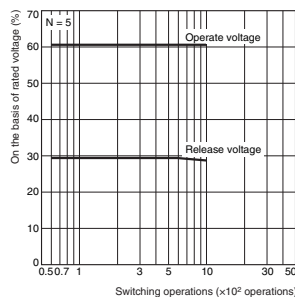

**Contact resistance**

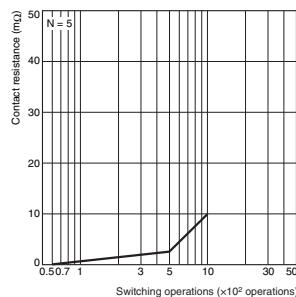

**Operate and Release voltages**

**N = 5**

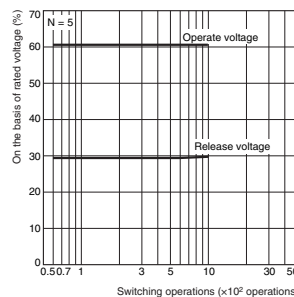

**Contact resistance**

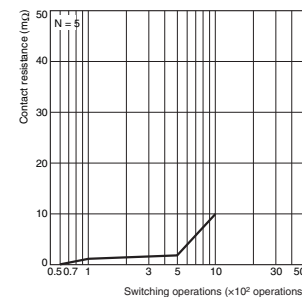

**Load conditions**

**• 1 φ 220 VAC**

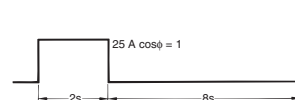

• Applied coil voltage: 75% of rated voltage

**Load conditions**

**• 1 φ 220 VAC**

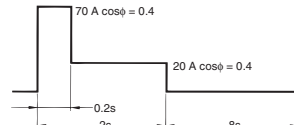

• Applied coil voltage: 75% of rated voltage

# Applications

- Compressors for package air conditioners and heater switching controllers
- Switching controllers for power tools or motors
- Power controllers for water heaters
- Power controllers for dryers
- Lamp control, motor drivers, and power supply switching in copy machines, facsimiles, and other office equipment
- Lighting controllers
- Power controllers for packers or food processing equipment
- Magnetron control in microwaves
- Power controllers for Uninterruptible Power Supplies (UPS)

# Dimensions

Unit: mm (inch)

## ■ Relays

### Quick-Connect Terminal Models

#### E-bracket Mounting\*

##### G7L-1A-T

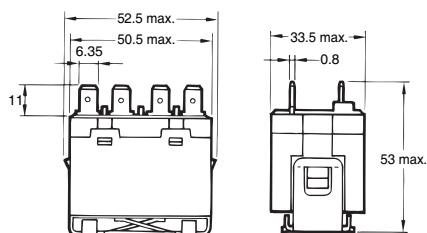
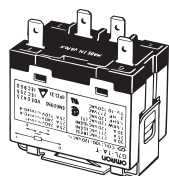

#### Terminal arrangement/ Internal connections (Top view)

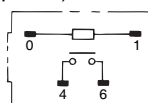

(No coil polarity)

**Note:** Refer to "Coil Internal Circuit" for the coil internal connection diagram.

##### G7L-2A-T

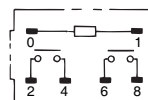
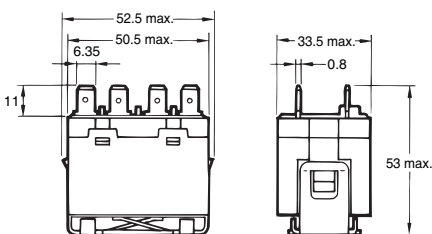
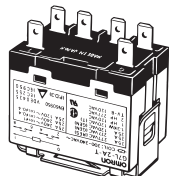

(No coil polarity)

**Note:** Refer to "Coil Internal Circuit" for the coil internal connection diagram.

##### G7L-1A-TJ (with Test Button)

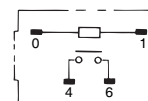
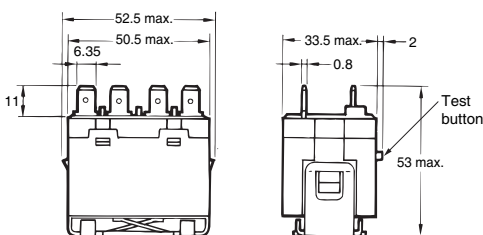
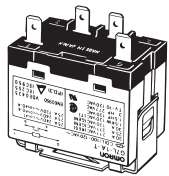

(No coil polarity)

**Note:** Refer to "Coil Internal Circuit" for the coil internal connection diagram.

##### G7L-2A-TJ (with Test Button)

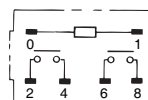
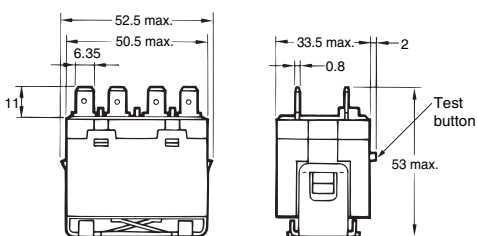
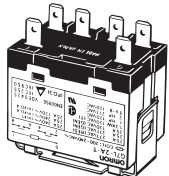

(No coil polarity)

**Note:** Refer to "Coil Internal Circuit" for the coil internal connection diagram.

#### Mounting holes

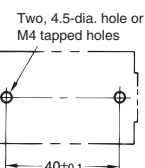

\* E brackets are sold separately

### Adapter Mounting\*

#### G7L-1A-T

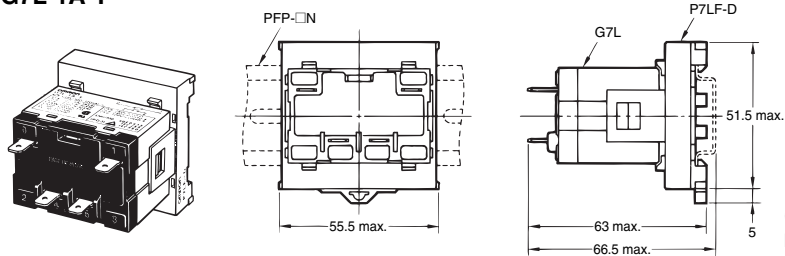

**Terminal arrangement/  
Internal connections  
(Top view)**

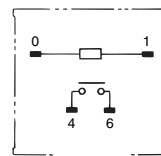

(No coil polarity)

**Note:** Refer to "Coil Internal Circuit" for the coil internal connection diagram.

#### G7L-2A-T

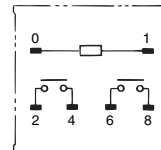
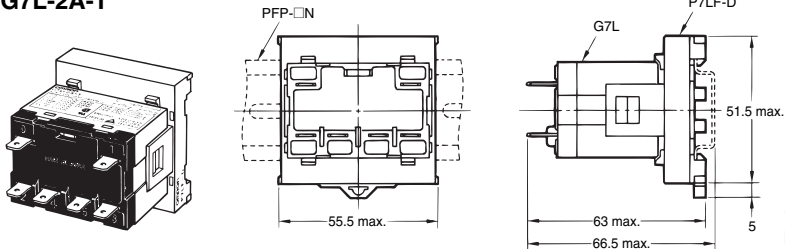

(No coil polarity)

**Note:** Refer to "Coil Internal Circuit" for the coil internal connection diagram.

#### Mounting holes

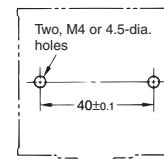

#### G7L-1A-TJ (with Test Button)

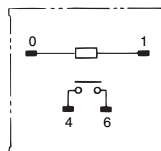
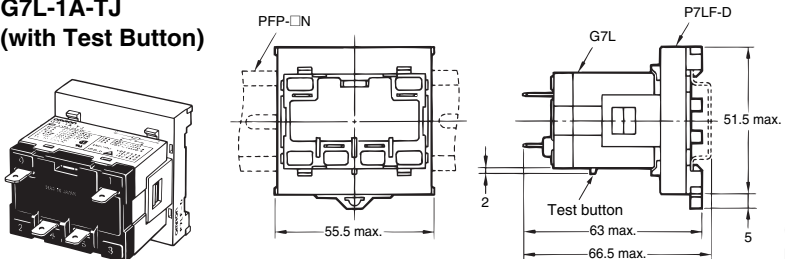

(No coil polarity)

**Note:** Refer to "Coil Internal Circuit" for the coil internal connection diagram.

#### G7L-2A-TJ (with Test Button)

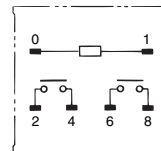
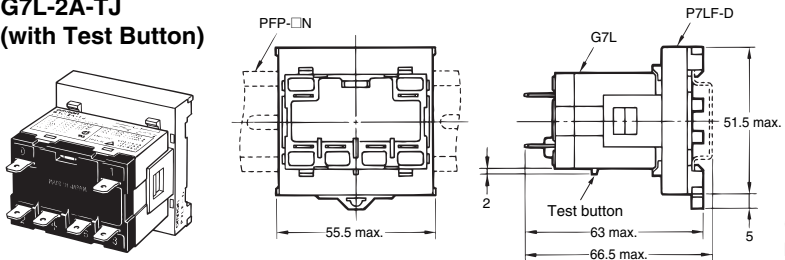

(No coil polarity)

**Note:** Refer to "Coil Internal Circuit" for the coil internal connection diagram.

\* The DIN Track Mounting Adapter and DIN tracks are sold separately. The adapter can be track-mounted or screw-mounted.

## Front-connecting Socket Mounting\*

### G7L-1A-T

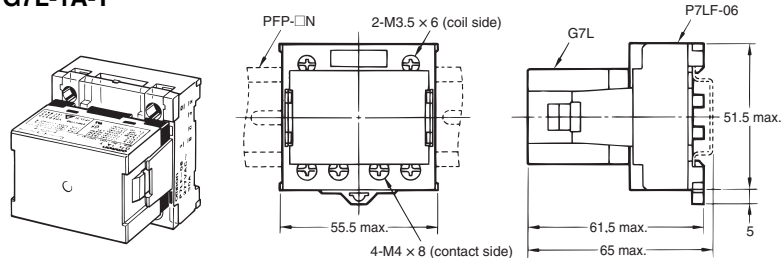

#### Terminal arrangement/ Internal connections (Top view)

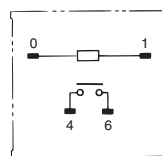

(No coil polarity)

**Note:** Refer to "Coil Internal Circuit" for the coil internal connection diagram.

### G7L-2A-T

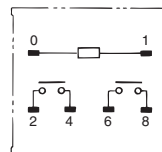
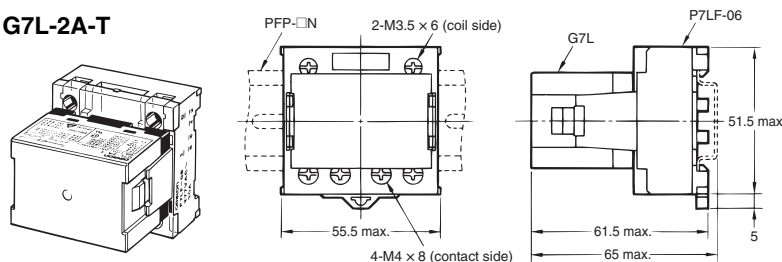

(No coil polarity)

**Note:** Refer to "Coil Internal Circuit" for the coil internal connection diagram.

#### Mounting holes

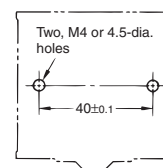

### G7L-1A-TJ (with Test Button)

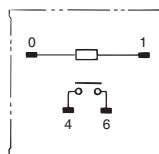
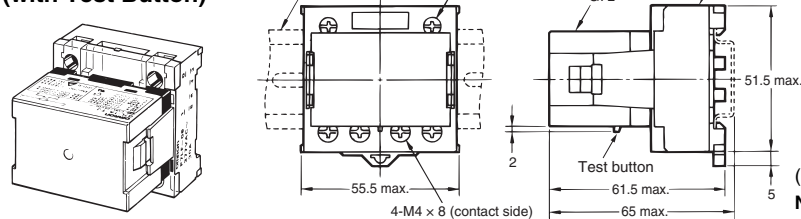

(No coil polarity)

**Note:** Refer to "Coil Internal Circuit" for the coil internal connection diagram.

### G7L-2A-TJ (with Test Button)

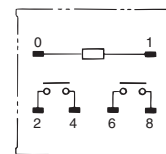
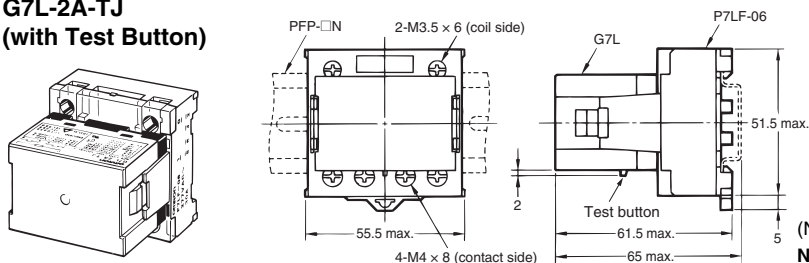

(No coil polarity)

**Note:** Refer to "Coil Internal Circuit" for the coil internal connection diagram.

\* The Front-connecting Socket and DIN tracks are sold separately. The socket can be track-mounted or screw-mounted.



## Upper Bracket Mounting

### G7L-1A-TUB

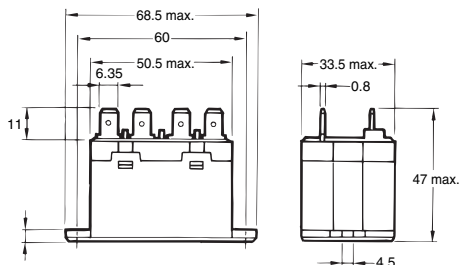
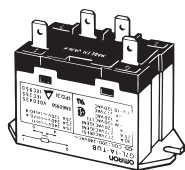

#### Terminal arrangement/ Internal connections (Top view)

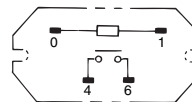

(No coil polarity)

**Note:** Refer to "Coil Internal Circuit" for the coil internal connection diagram.

### G7L-2A-TUB

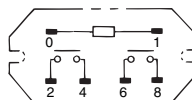
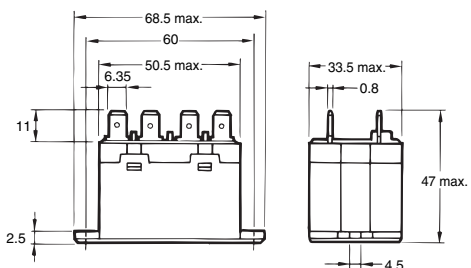
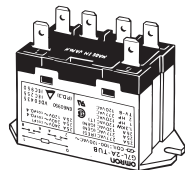

(No coil polarity)

**Note:** Refer to "Coil Internal Circuit" for the coil internal connection diagram.

#### Mounting holes

Two, 4.5-dia. hole or  
M4 tapped holes

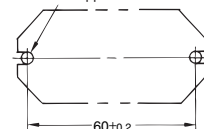

### G7L-1A-TUBJ (with Test Button)

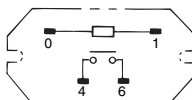
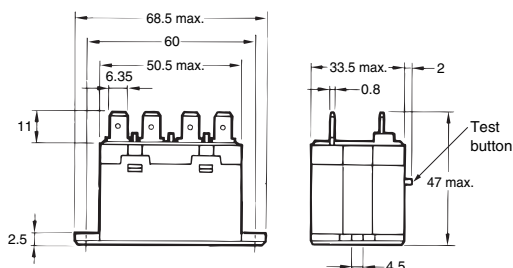
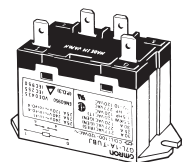

(No coil polarity)

**Note:** Refer to "Coil Internal Circuit" for the coil internal connection diagram.

### G7L-2A-TUBJ (with Test Button)

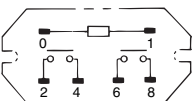
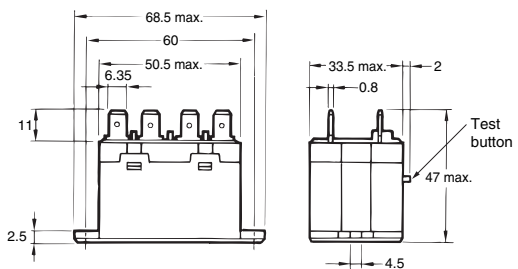
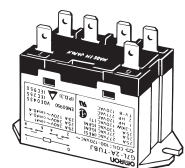

(No coil polarity)

**Note:** Refer to "Coil Internal Circuit" for the coil internal connection diagram.

## Screw Terminal Models

### E-bracket Mounting\*

#### G7L-1A-B

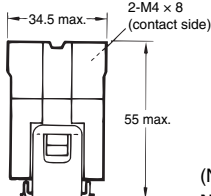
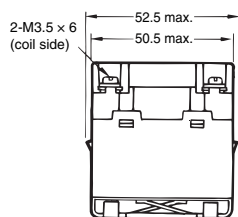
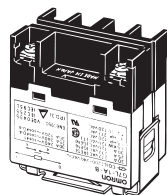

#### Terminal arrangement/ Internal connections (Top view)

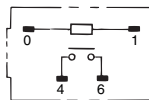

(No coil polarity)

**Note:** Refer to "Coil Internal Circuit" for the coil internal connection diagram.

#### G7L-2A-B

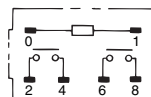
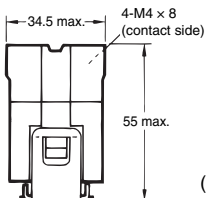
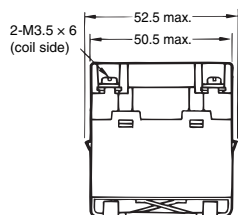
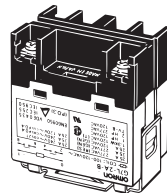

(No coil polarity)

**Note:** Refer to "Coil Internal Circuit" for the coil internal connection diagram.

#### Mounting holes

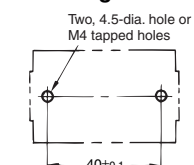

#### G7L-1A-BJ (with Test Button)

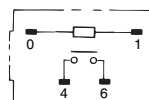
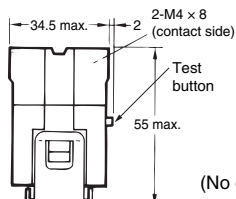
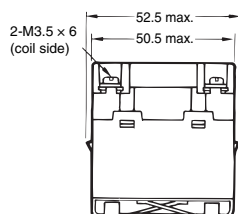
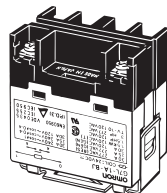

(No coil polarity)

**Note:** Refer to "Coil Internal Circuit" for the coil internal connection diagram.

#### G7L-2A-BJ (with Test Button)

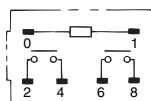
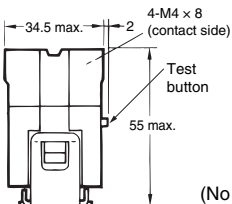
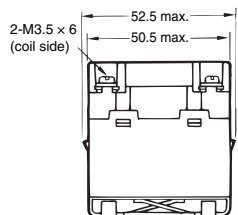
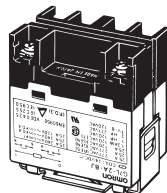

(No coil polarity)

**Note:** Refer to "Coil Internal Circuit" for the coil internal connection diagram.

\* E brackets are sold separately

### Adapter Mounting\*

#### G7L-1A-B

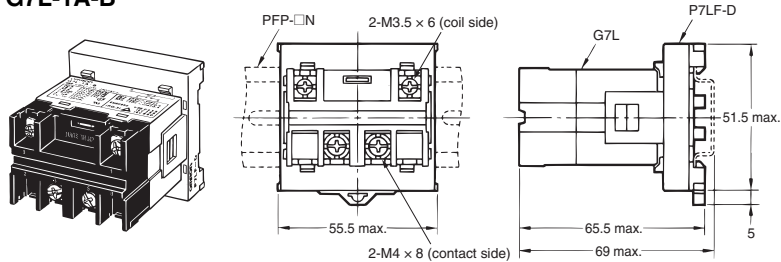

#### Terminal arrangement/ Internal connections (Top view)

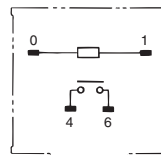

(No coil polarity)

**Note:** Refer to "Coil Internal Circuit" for the coil internal connection diagram.

#### G7L-2A-B

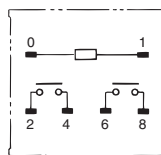
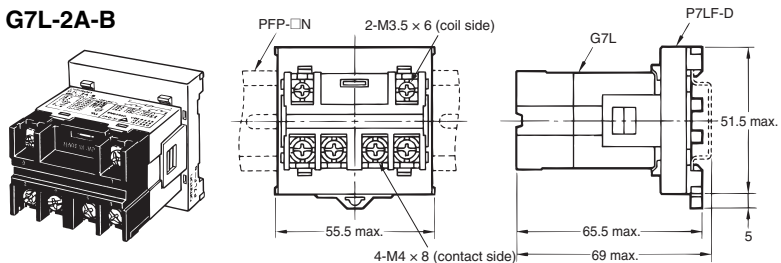

(No coil polarity)

**Note:** Refer to "Coil Internal Circuit" for the coil internal connection diagram.

#### Mounting holes

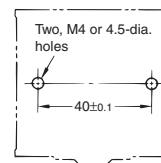

#### G7L-1A-BJ (with Test Button)

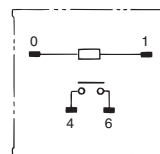
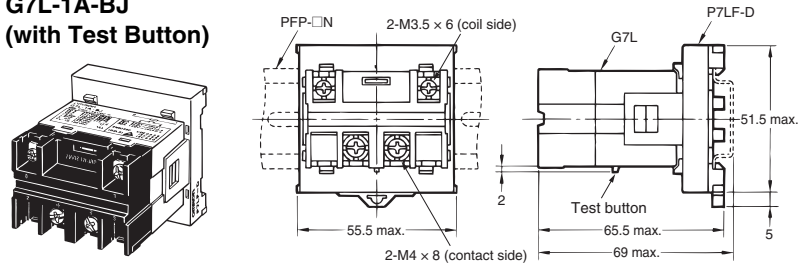

(No coil polarity)

**Note:** Refer to "Coil Internal Circuit" for the coil internal connection diagram.

#### G7L-2A-BJ (with Test Button)

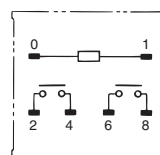
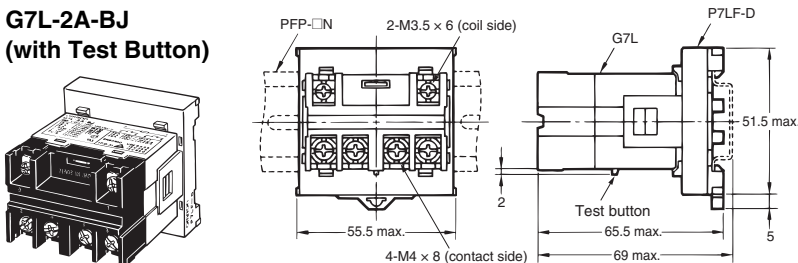

(No coil polarity)

**Note:** Refer to "Coil Internal Circuit" for the coil internal connection diagram.

\* The DIN Track Mounting Adapter and DIN tracks are sold separately. The adapter can be track-mounted or screw-mounted.

## Upper Bracket Mounting

### G7L-1A-BUB

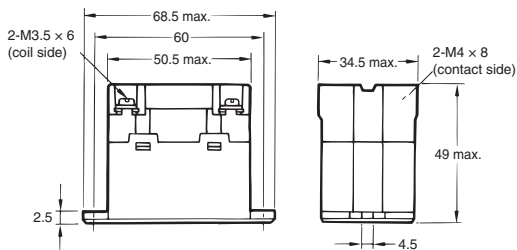
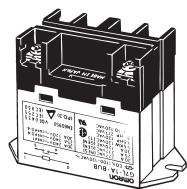

#### Terminal arrangement/ Internal connections (Top view)

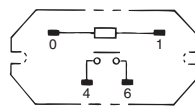

(No coil polarity)

**Note:** Refer to "Coil Internal Circuit" for the coil internal connection diagram.

### G7L-2A-BUB

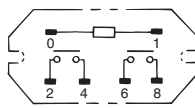
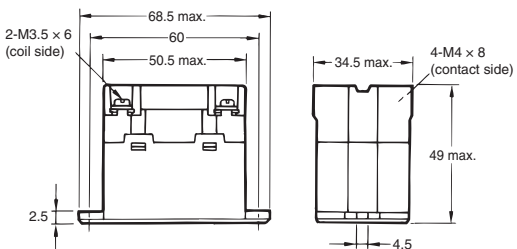
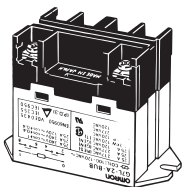

(No coil polarity)

**Note:** Refer to "Coil Internal Circuit" for the coil internal connection diagram.

#### Mounting holes

Two, 4.5-dia. hole or  
M4 tapped holes

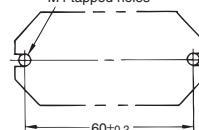

### G7L-1A-BUBJ (with Test Button)

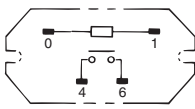
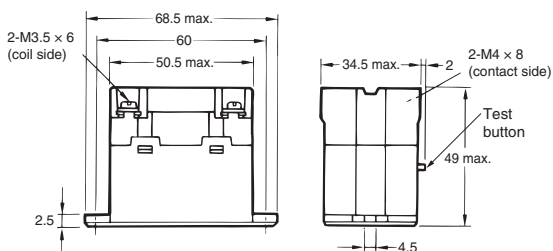
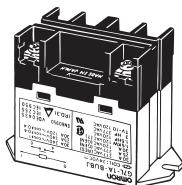

(No coil polarity)

**Note:** Refer to "Coil Internal Circuit" for the coil internal connection diagram.

### G7L-2A-BUBJ (with Test Button)

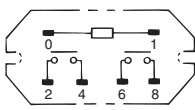
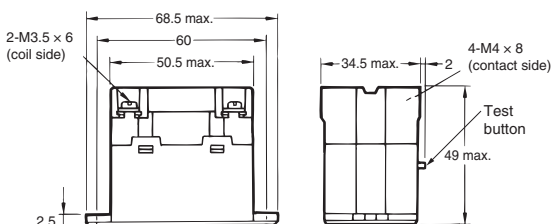
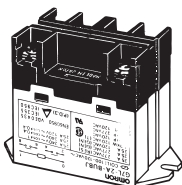

(No coil polarity)

**Note:** Refer to "Coil Internal Circuit" for the coil internal connection diagram.

## PCB Terminal Models

### G7L-1A-P

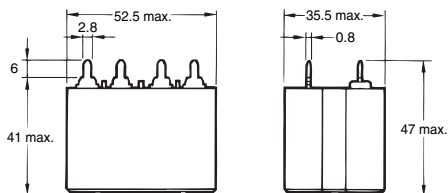
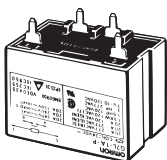

#### Terminal arrangement/ Internal connections (Top view)

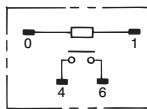

(No coil polarity)

**Note:** Refer to "Coil Internal Circuit" for the coil internal connection diagram.

#### PCB Mounting holes (Bottom view)

Tolerance  $\pm 0.1$  mm

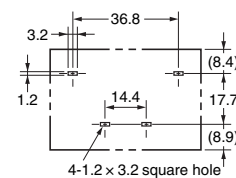

### G7L-2A-P

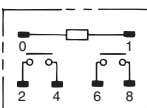
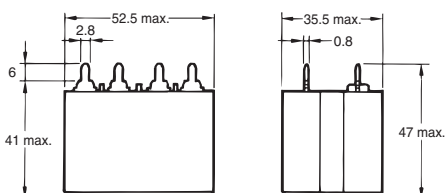
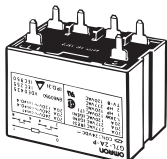

(No coil polarity)

**Note:** Refer to "Coil Internal Circuit" for the coil internal connection diagram.

#### PCB Mounting holes (Bottom view)

Tolerance  $\pm 0.1$  mm

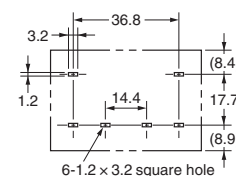

## Accessories (Sold Separately)

### E bracket R99-07G7L

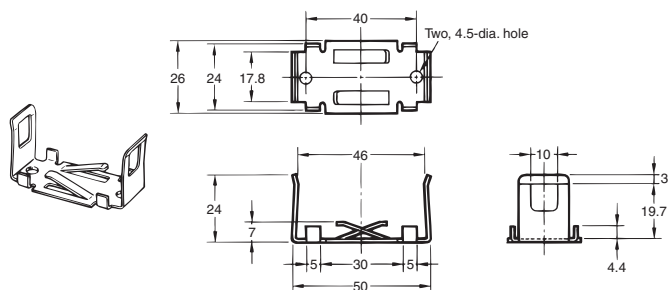

#### Mounting holes (Bottom view)

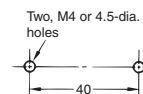

### Adapter P7LF-D

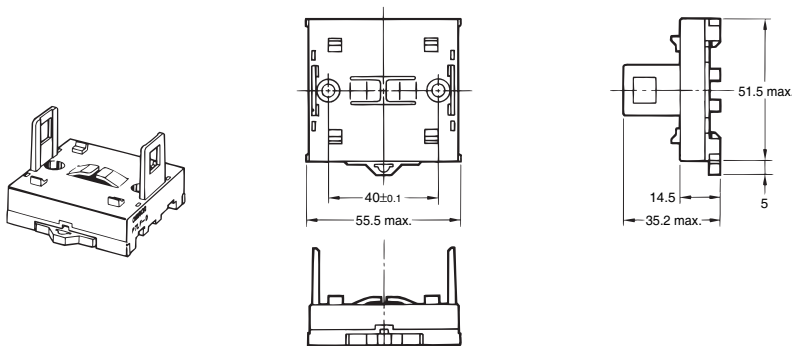

#### Mounting holes (Bottom view)

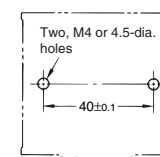

### Front connecting socket P7LF-06

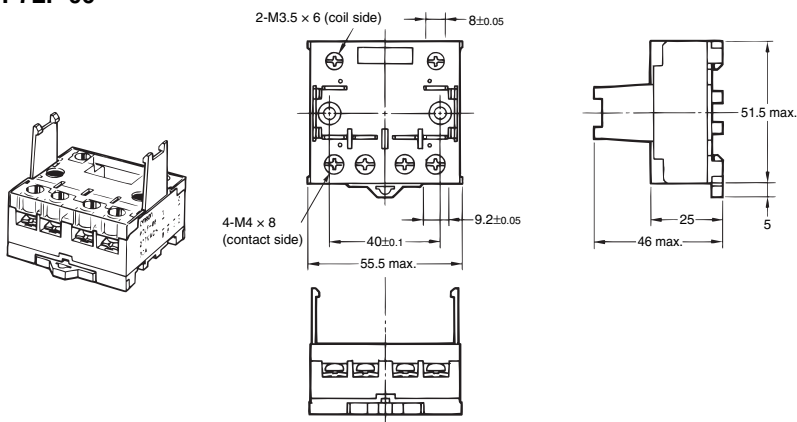

#### Mounting holes (Bottom view)

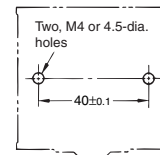

- Note:**
1. To protect against electric shock, a socket terminal cover is supplied with the P7LF-06 socket. It cannot be purchased separately.
  2. The P7LF-D and P7LF-06 are panel or track mountable.
  3. The P7LF-D is for use with quick connect or screw models that accept the E-bracket.
  4. The P7LF-06 is for use with quick connect models that accept the e-bracket.

### Cover P7LF-C

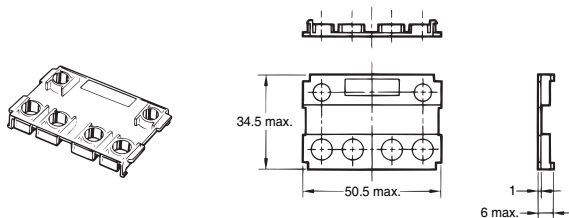

**Note:** P7LF-C cover attaches directly to G7L-B style relays. To protect against electric shock, use the P7LF-C on G7L-B terminals.

Mounting track

PFP-100N, PFP-50N  
(Conforming to EN 50022)

PFP-100N2  
(Conforming to EN 50022)

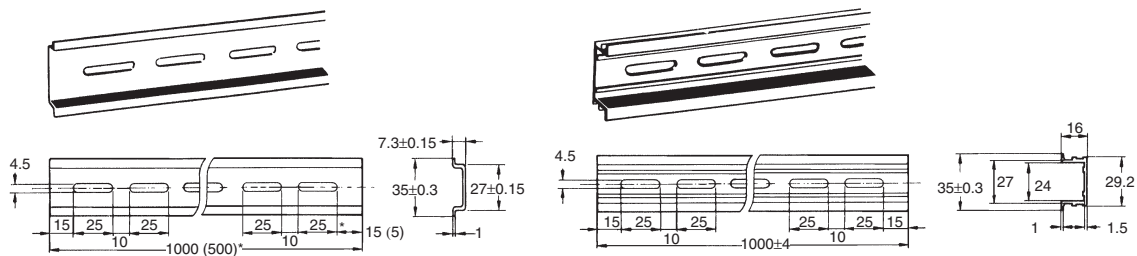

\* The figure in parenthesis is for PFP-50N.

**Note: 1.** It is recommended that a panel thickness of 1.60 to 2.00 mm (0.06 to 0.08 in) be used.

**2.** L = Length

PFP-100N L = 1 m (39.00 in)

PFP-50N L = 50 cm (19.60 in)

PFP-100N2 L = 1 m (39.00 in)

End plate

PFP-M

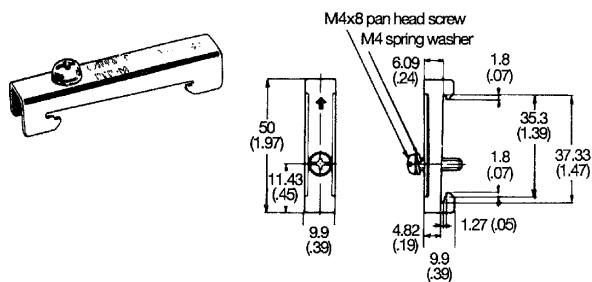

Spacer

PFP-S

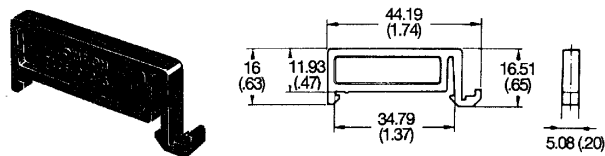

## ■ Approvals

- A variety of Safety Standard approved products for standard models.

### UL approval (File No. E41643)

Model	Coil ratings	Contact ratings	Number of test operations
		SPST-NO	
G7L-1A-T□ G7L-1A-B□ G7L-1A-P□ G7L-2A-T□ G7L-2A-B□ G7L-2A-P□	12 to 240 VAC 6 to 220 VDC	30 A, 277 VAC (RES) 40°C	100,000
		1.5 kW, 120 VAC (T) 40°C	6,000
		1.5 HP, 120 VAC 40°C	1,000
		3 HP 277 VAC 40°C	100,000
		20 FLA/120 LRA, 120 VAC 40°C	30,000
		17 FLA/102 LRA, 277 VAC 40°C	30,000
		TV-10, 120 VAC 40°C	25,000

### CSA approval (File No. LR31928)

Model	Coil ratings	Contact ratings	Number of test operations
		SPST-NO	
G7L-1A-P	12 to 240 VAC 6 to 220 VDC	2.4 kW, 120 VAC (T) 40°C	6,000
		1.5 HP, 120 VAC (T) 40°C	1,000
		3 HP 277 VAC 40°C	100,000
		20.5 FLA/105 LRA, 120 VAC 85°C	100,000
		TV-10, 120 VAC 40°C	25,000
G7L-1A-T□ G7L-1A-B□ G7L-2A-T□ G7L-2A-B□ G7L-2A-P□	12 to 240 VAC 6 to 220 VDC	30 A, 277 VAC (RES) 40°C	100,000
		2.4 kW, 120 VAC (T) 40°C	6,000
		1.5 HP, 120 VAC 40°C	1,000
		3 HP 277 VAC 40°C	100,000
		20.5 FLA/105 LRA, 120 VAC 85°C	100,000
		TV-10, 120 VAC 40°C	25,000

### Reference

UL Approved Type .....

- UL508 Industrial Control Devices
- UL1950 Information processing equipment  
(Including office equipment)

CSA Approved Type.....

- CSA C22.2 No.1, 14  
Industrial Control Devices
- CSA C22.2 No.950 Information processing equipment  
(Including office equipment)

TÜV EN/IEC Standard Approved Type.....

- EN61810-1 Relay
- EN60950 Information processing equipment  
(Including office equipment)
- IEC950 Information processing equipment  
(Including office equipment)

### VDE recognized type (License no. 1530 UG)

**Note:** 1. Please consult OMRON for details of VDE approvals.

2. The G7L relay conforms to the following standards:

Electrical safety: DIN IEC 255 Teil 1-00/DIN VDE 0435 Teil 201/05. 83  
DIN VDE 0435 Teil 201 A1/05. 90  
DIN IEC 255 Teil 0-20/DIN VDE 0435 Teil 120/10. 81  
DIN EN 60 950/VDE 0805/11. 93

EMC: prEN 50082-2, EN 55022

3. The rated values approved by each of the safety standards (e.g., UL and CSA) may be different from the performance characteristics individually defined in this catalog.
4. In the interest of product improvement, specifications are subject to change.
5. Suffix T130 rated at 130°C
6. Pollution degree 3, Material Group II & III.
7. CE marking is provide only on non-PCB terminal versions.

### EN/IEC, TÜV Approval (File No. R50059083)

Model	Coil ratings	Contact ratings	Approved switching operations
		SPST-NO	
G7L-1A-B□	6, 12, 24, 48, 100, 110, 200, 220 VDC 12, 24, 50, 100 to 120, 200 to 240 VAC	30 A, 250 VAC ~ (cosφ = 1) 60°C 25 A, 250 VAC ~ (cosφ = 0.4) 60°C 30 A, 120 VAC ~ (cosφ = 0.4) 60°C	50,000
G7L-2A-B□		DPST-NO 25 A, 277 VAC ~ (cosφ = 1) 60°C 25 A, 277 VAC ~ (cosφ = 0.4) 60°C	50,000
G7L-1A-T□		SPST-NO 25 A, 240 VAC ~ (cosφ = 1) 60°C 25 A, 240 VAC ~ (cosφ = 0.4) 60°C 25 A, 277 VAC ~ (cosφ = 1) 60°C 25 A, 277 VAC ~ (cosφ = 0.4) 60°C	50,000
G7L-2A-T□		DPST-NO 25 A, 240 VAC ~ (cosφ = 1) 60°C 25 A, 240 VAC ~ (cosφ = 0.4) 60°C 25 A, 277 VAC ~ (cosφ = 1) 60°C 25 A, 277 VAC ~ (cosφ = 0.4) 60°C	50,000
G7L-1A-P		SPST-NO 20 A, 240 VAC ~ (cosφ = 1) 60°C 20 A, 240 VAC ~ (cosφ = 0.4) 60°C 25 A, 277 VAC ~ (cosφ = 1) 60°C 25 A, 277 VAC ~ (cosφ = 0.4) 60°C	50,000
G7L-2A-P		DPST-NO 20 A, 240 VAC ~ (cosφ = 1) 60°C 20 A, 240 VAC ~ (cosφ = 0.4) 60°C 25 A, 277 VAC ~ (cosφ = 1) 60°C 25 A, 277 VAC ~ (cosφ = 0.4) 60°C	50,000



# Precautions

## ■ Correct Use

### Handling

To preserve initial performance, do not drop or otherwise subject the power relay to shock.

The case is not designed to be removed during normal handling and operation. Doing so may affect performance.

Use the power relay in a dry environment free from excessive dust, SO<sub>2</sub>, H<sub>2</sub>S, or organic gas.

Do not allow a voltage greater than the maximum allowable coil voltage to be applied continuously.

Do not use the power relay outside of specified voltages and currents.

Do not allow the ambient operating temperature to exceed the specified limit.

### Installation

Although there are not specific limits on the installation site, it should be as dry and dust-free as possible.

Using in an atmosphere of high humidity and corrosive gas may deteriorate its performance characteristic caused by condensation or corrosive products, resulting in failure or burn damage of the Relay.

PCB terminal-equipped relays weigh approximately 100 g. Be sure that the PCB is strong enough to support them. We recommend dual-side through-hole PCBs to reduce solder cracking from heat stress.

Relays with test buttons must be mounted facing down. Be careful not to touch the test button accidentally. Doing so may turn on the contact.

Be sure to use the test button for test purposes only (with test-button models). The test button is used for Relay circuit tests, such as circuit continuity tests. Do not attempt to switch the load with the test button.

### Soldering PCB Terminals

Do not perform automatic soldering, but solder manually.

Do not wash down the entire Relay because it does not have an airtight construction.

### Connecting

Refer to the following table when connecting a wire with a crimp style terminal to the G7L.

	Screw Terminals	Front Connecting Socket
<b>Coil</b>		
<b>Contact</b>		

Allow suitable slack on leads when wiring and do not apply excessive force to the terminals.

Tightening torque;

Coil: 0.78 to 1.18 N·m

Contacts: 0.98 to 1.37 N·m

When connecting with screws, if the screws are not sufficiently tightened, the lead wire can become detached and may lead to abnormal heating or fire caused by faulty contact.

Do not apply excessive force when mounting or dismantling the faston receptacle. Insert and remove terminals carefully, one at a time. Do not insert terminals at an angle, or insert / remove multiple terminals at the same time.

Do not connect to the terminals by soldering. Use #250 faston or positive-lock connectors;

Type	Receptacle Terminals*	Positive Housing
#250 terminals (width: 6.35 mm)	AMP 170333-1 (170327-1) AMP 170334-1 (170328-1) AMP 170335-1 (170329-1)	AMP 172076-1 natural color AMP 172076-4 yellow AMP 172076-5 green AMP 172076-5 blue

\*the numbers shown in parentheses are for air-feeding.

- Note:** 1. The current should be 25A when using receptacle terminals.  
2. Use receptacle terminals or positive housing for cable wiring.

### Mounting

#### Top Bracket Type

Mounting torque; 0.98 N·m

Tighten with to M4 screws when mounting.

#### DIN Track Mounting Adapter and Front-Connecting Socket

The DIN Track Mounting Adapter and Front-connecting Socket can be mounted on the G7L with just one hand and dismantled with ease using a screwdriver.

To support the G7L mounted on a DIN Track Mounting Adapter or Front-connecting Socket, use the PFP-M End Plate. Put the End Plate onto the DIN Track Mounting Adapter or Front-connecting Socket so that the surface mark of the End Plate faces upwards. Then tighten the screw of the End Plate securely with a screwdriver.

#### Screw Mounting

Screw-mount the DIN Track Mounting Adapter or Front-connecting Socket securely after opening screw mounting holes on them.

When cutting or opening holes on the panel after the Front-connecting Socket is mounted, take proper measures so that the cutting chips will not fall onto the Relay terminals. When cutting or opening holes on the upper part of the panel, mask the Front-connecting Socket properly with a cover.

### Operating Coil

- As a rule, either a battery or a DC power supply with a maximum 5% ripple is used for the operating voltage for DC relays. Before using a rectified AC supply, confirm that the ripple is not greater than 5%. Ripple greater than this can lead to variations in the operating and reset voltages.

As excessive ripple can generate beats, the insertion of a smoothing capacitor is recommended as shown below.

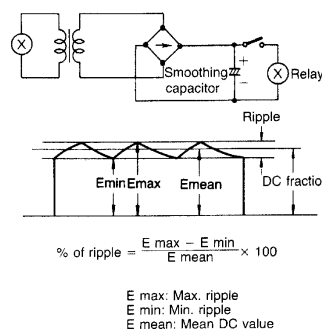

- When driving a transistor, check the leakage current and connect a bleeder resistor if necessary.
- Momentary voltage drops on coil input voltage should not exceed one second duration after contact mating with no shock or vibration.





All sales are subject to Omron Electronic Components LLC standard terms and conditions of sale, which can be found at [http://www.components.omron.com/components/web/webfiles.nsf/sales\\_terms.html](http://www.components.omron.com/components/web/webfiles.nsf/sales_terms.html)

**ALL DIMENSIONS SHOWN ARE IN MILLIMETERS.**  
To convert millimeters into inches, multiply by 0.03937. To convert grams into ounces, multiply by 0.03527.

---

**OMRON**<sup>®</sup>  
**OMRON ELECTRONIC  
COMPONENTS LLC**  
**847-882-2288**

**OMRON ON-LINE**  
Global - <http://www.omron.com>  
USA - <http://www.components.omron.com>

Cat. No. J055-E-09

08/14 (07/13) Specifications subject to change without notice

Printed in USA