

# Power PCB Relay G6C

## SPST-NO Type Breaks 10-A Loads; SPST-NO + SPST-NC Breaks 8-A Load

- Compact: 20 x 15 x 10 mm (L x W x H).
- Low power consumption: 200 mW.
- Semi-sealed or fully sealed construction available.
- Unique moving loop armature reduces relay size, magnetic interference, and contact bounce.
- Single and Dual coil latching types also available
- RoHS Compliant

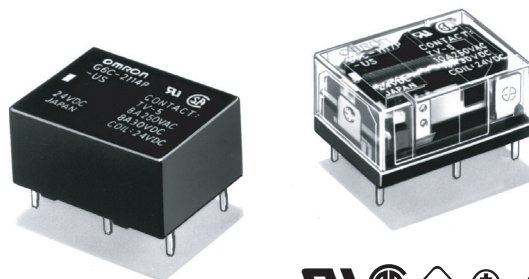

## Ordering Information

Classification	Contact form	Straight Through-hole PCB		Self-clinching Through-hole PCB	
		Semi-sealed	Fully sealed	Semi-sealed	Fully sealed
Non-latching	SPST-NO	G6C-1117P-US	G6C-1114P-US	G6C-1117C-US	G6C-1114C-US
	SPST-NO + SPST-NC	G6C-2117P-US	G6C-2114P-US	G6C-2117C-US	G6C-2114C-US
Single coil latching	SPST-NO	G6CU-1117P-US	G6CU-1114P-US	G6CU-1117C-US	G6CU-1114C-US
	SPST-NO + SPST-NC	G6CU-2117P-US	G6CU-2114P-US	G6CU-2117C-US	G6CU-2114C-US
Dual coil latching	SPST-NO	G6CK-1117P-US	G6CK-1114P-US	G6CK-1117C-US	G6CK-1114C-US
	SPST-NO + SPST-NC	G6CK-2117P-US	G6CK-2114P-US	G6CK-2117C-US	G6CK-2114C-US

**Note:** When ordering, add the rated coil voltage to the model number.

Example: G6C-1117P-US DC12

Rated coil voltage

### Model Number Legend

G6C  -     -  -  DC

1    2    3    4    5    6    7    8

**1. Relay Function**

- None: Non-latching
- U: Single coil latching
- K: Dual coil latching

**2. Contact Form**

- 11: SPST-NO
- 21: SPST-NO + SPST-NC

**3. Contact Type**

- 1: Standard

**4. Enclosure Ratings**

- 4: Fully sealed
- 7: Semi-sealed

**5. Terminals**

- P: Straight Through-hole PCB
- C: Self-clinching Through-hole PCB

**6. Approved Standards**

- US: UL/CSA certified

**7. Mounting Method**

- None: Mount directly to PCB
- P6C: Mount to Socket

**8. Rated Coil Voltage**

- 3, 5, 6, 12, or 24 VDC

## ■ Accessories (Order Separately)

### Back Connecting Sockets

Applicable Relay	Back Connecting Socket (See note 1.)
G6C(U)-1114P-US-P6C G6C(U)-1117P-US-P6C G6C(U)-2114P-US-P6C G6C(U)-2117P-US-P6C	P6C-06P
G6CK-1114P-US-P6C G6CK-1117P-US-P6C G6CK-2114P-US-P6C G6CK-2117P-US-P6C	P6C-08P

- Note:** 1. Not applicable to the self-clinching versions.  
The operating current for the socket is 5 A max.
2. Use the G6C(U)-□□□□P-US-**P6C** if mounting relays in a P6C Socket.

Removal Tool	P6B-Y1
Hold-down Clips	P6B-C2

## Specifications

### ■ Contact Ratings

Item	SPST-NO		SPST-NO+SPST-NC	
	Resistive load ( $\cos\phi = 1$ )	Inductive load ( $\cos\phi = 0.4$ ; L/R = 7 ms)	Resistive load ( $\cos\phi = 1$ )	Inductive load ( $\cos\phi = 0.4$ ; L/R = 7 ms)
Rated load	10 A at 250 VAC; 10A at 30 VDC	5 A at 250 VAC; 5 A at 30 VDC	8 A at 250 VAC; 8A at 30 VDC	3.5 A at 250 VAC; 3.5 A at 30 VDC
Contact material	Ag Alloy (Cd free)			
Rated carry current	10 A		8 A	
Max. switching voltage	380 VAC, 125 VDC (the case of latching 250 VAC, 125 VDC)			
Max. switching current	10 A		8 A	
Max. switching capacity	2,500 VA, 300 W	1,250 VA, 220 W	2,000 VA, 240 W	875 VA, 170 W
Min. permissible load (reference value - see note)	10 mA at 5 VDC			

**Note:** P level:  $\lambda_{60} = 0.1 \times 10^{-6}$  operations

### ■ Coil Data

#### Non-latching

Rated voltage (VDC)	Rated current (mA)	Coil resistance ( $\Omega$ )	Coil inductance (ref. value) (H)		Pick-up voltage	Dropout voltage	Maximum voltage	Power consumption (mW)
			Armature OFF	Armature ON				
3	67	45	0.078	0.067	70% max.	10% min.	160% max. at 23°C	Approx. 200
5	40	125	0.22	0.18				
6	33.30	180	0.36	0.29				
12	16.70	720	1.32	1.13				
24	8.30	2,880	4.96	4.19				

- Note:** 1. The rated current and coil resistance are measured at a coil temperature of 23°C with a tolerance of  $\pm 10\%$ .
2. Operating characteristics are measured at a coil temperature of 23°C.

### Single Coil Latching Type

Rated voltage (VDC)	Rated current (mA)	Coil resistance (Ω)	Coil inductance (ref. value) (H)		Set pick-up voltage	Reset pick-up voltage	Maximum voltage	Power consumption (mW)
			Armature OFF	Armature ON	% of rated voltage			
3	67	45	0.09	0.06	70% max.	70% min.	160% max. at 23°C	Approx. 200
5	40	125	0.25	0.20				
6	33.30	180	0.36	0.24				
12	16.70	720	1.75	1.17				
24	8.30	2,880	5.83	3.84				

### Dual Coil Latching Type

Rated voltage (VDC)	Rated current (mA)	Coil resistance (Ω)	Coil inductance (ref. value) (H)				Set pick-up voltage	Reset pick-up voltage	Maximum voltage	Power consumption (mW)
			Set Coil		Reset Coil					
			Armature OFF	Armature ON	Armature OFF	Armature ON	% of rated voltage			
3	93.50	32.10	0.03	0.02	0.03	0.02	70% max.	70% max.	130% max. at 23°C)	Approx. 280
5	56	89.30	0.07	0.06	0.08	0.07				
6	46.70	129	0.10	0.08	0.12	0.10				
12	23.30	514	0.37	0.32	0.47	0.38				
24	11.70	2,056	1.56	1.18	1.46	1.13				

- Note:** 1. The rated current and coil resistance are measured at a coil temperature of 23°C with a tolerance of ±10%.  
 2. Operating characteristics are measured at a coil temperature of 23°C.  
 3. The minimum pulse width of the set and reset voltage is 20 ms.

## ■ Characteristics

<b>Contact resistance</b>		30 mΩ max.
<b>Operate (set) time</b>		10 ms max. (mean value: approx. 5 ms)
<b>Release (reset) time</b>		10 ms max. (mean value: approx. 2 ms; latching types: mean value: approx. 5 ms)
<b>Bounce time</b>		5 ms max. (Approx. 3 ms typical)
<b>Min. set/reset signal width</b>		Latching type: 20 ms (at 23°C)
<b>Max. switching frequency</b>	<b>Mechanical</b>	18,000 operations/hr
	<b>Electrical</b>	1,800 operations/hr (under rated load)
<b>Insulation resistance</b>		1,000 MΩ min. (at 500 VDC, at 250 VDC between set coil and reset coil)
<b>Dielectric strength</b>		2,000 VAC, 50/60 Hz for 1 min between coil and contacts 2,000 VAC, 50/60 Hz for 1 min between contacts of different polarity 1,000 VAC, 50/60 Hz for 1 min between contacts of same polarity 250 VAC, 50/60 Hz for 1 min between set and reset coils (double winding latching type)
<b>Surge withstand voltage</b>		6,000 V (1.2 x 50 μs) between coil and contacts (latching types: 4,500 V, 1.2 x 50 μs)
<b>Vibration resistance</b>	<b>Mechanical durability</b>	10 to 55 Hz, 1.5-mm double amplitude
	<b>Malfunction durability</b>	10 to 55 Hz, 1.5-mm double amplitude
<b>Shock resistance</b>	<b>Mechanical durability</b>	1,000 m/s <sup>2</sup> (Approx. 100G)
	<b>Malfunction durability</b>	100 m/s <sup>2</sup> (Approx. 10G)
<b>Ambient temperature</b>		Operating: -25°C to 70°C (with no icing)
<b>Ambient humidity</b>		Operating: 5% to 85%
<b>Service Life</b>	<b>Mechanical:</b>	50,000,000 operations min. (at 18,000 operations/hr)
	<b>Electrical:</b>	100,000 operations min. (at 1,800 operations/hr) See "Characteristic Data"
<b>Weight</b>		Approx. 5.6 g

## ■ Approved Standards

UL Recognized (File No. E41643) -- See note

Model	Contact form	Coil rating	Contact rating
G6C-1114P-US G6C-1114C-US G6C-1117P-US G6C-1117C-US	SPST-NO	3 to 60 VDC	10 A, 250 VAC (general use) 10 A, 30 VDC (resistive load) 1/6 hp, 125 VAC 1/4 hp, 125 VAC 1/4 hp, 250 VAC 1/3 hp, 250 VAC TV-5 (40°C, 25,000 operations) 600 W, 120 VAC (tungsten) 530 VA, 20 to 265 VAC, 2 A max. (pilot duty) 43.2 VA, 30 VDC (pilot duty) 12LRA, 2.2FLA, 30 VDC (30,000 operations)
G6C-2114P-US G6C-2114C-US G6C-2117P-US G6C-2117C-US	SPST-NO + SPST-NC		8 A, 250 VAC (general use) 8 A, 30 VDC (resistive load) 1/6 hp, 125 VAC 1/4 hp, 125 VAC 1/4 hp, 250 VAC 1/3 hp, 250 VAC TV-5 (40°C, 25,000 operations) 600 W, 120 VAC (tungsten) 530 VA, 20 to 265 VAC, 2 A max. (pilot duty) 43.2 VA, 30 VDC (pilot duty) 12LRA, 2.2FLA, 30 VDC (30,000 operations)

Note: UL Recognition tests performed at 80°C for 6,000 operations unless otherwise specified.

CSA Certified (File No. LR31928)

Model	Contact form	Coil rating	Contact rating
G6C-1114P-US G6C-1114C-US G6C-1117P-US G6C-1117C-US	SPST-NO	3 to 60 VDC	10 A, 250 VAC (general use) 10 A, 30 VDC (resistive load) 1/6 hp, 125 VAC 1/4 hp, 125 VAC 1/4 hp, 250 VAC 1/3 hp, 250 VAC TV-5 600 W, 120 VAC (tungsten)
G6C-2114P-US G6C-2114C-US G6C-2117P-US G6C-2117C-US	SPST-NO + SPST-NC	3 to 60 VDC	8 A, 250 VAC (general use) 8 A, 30 VDC (resistive load) 1/6 hp, 125 VAC 1/4 hp, 125 VAC 1/4 hp, 250 VAC TV-5 600 W, 120 VAC (tungsten)

VDE (Approval No. 2413) EN61810-1

Model	Contact form	Coil rating	Contact rating	Number of test operations
G6C-1114P-US G6C-1114C-US G6C-1117P-US G6C-1117C-US	SPST-NO	3, 12, 24 VDC	10 A, 250 VAC (cosφ = 1) 5 A, 250 VAC (cosφ = 0.4)	100,000 operations
G6C-2114P-US G6C-2114C-US G6C-2117P-US G6CU-2117P-VD	SPST-NO + SPST-NC	Single-stable: 3, 5, 12, 24 VDC Latching: 5 VDC G6CU-2117P-VD: 3 VDC	7 A, 250 VAC (cosφ = 1) 3.5 A, 250 VAC (cosφ = 0.4)	100,000 operations

# Engineering Data

## Maximum Switching Capacity SPST-NO

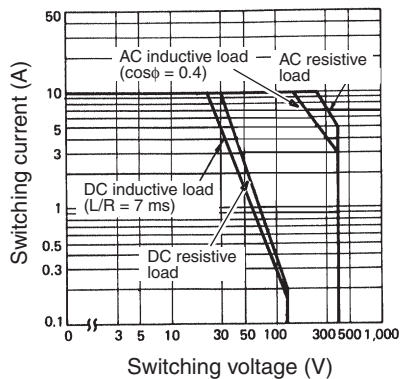

## SPST-NO + SPST-NC

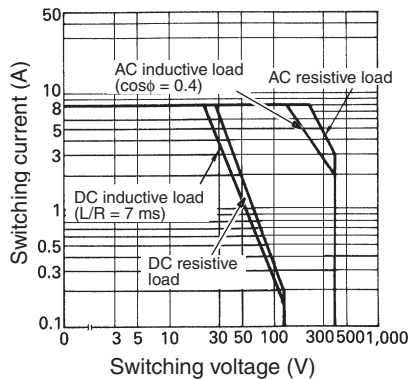

## Service Life

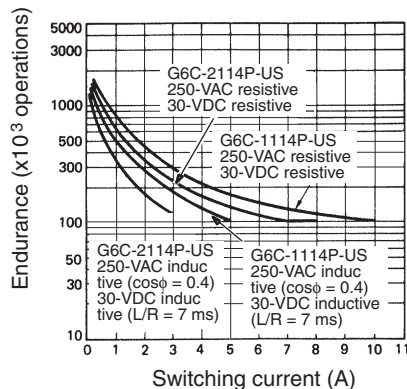

## Ambient Temperature vs. Maximum Coil Voltage

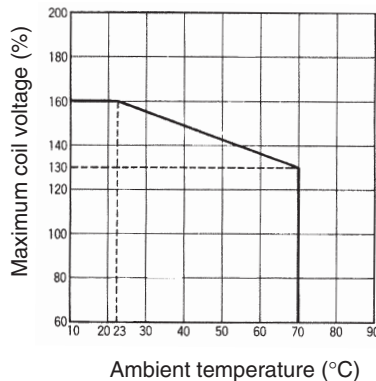

**Note:** The maximum coil voltage refers to the maximum value in a varying range of operating power voltage, not a continuous voltage.

# Dimensions

Note: 1. All units are in millimeters unless otherwise indicated.

2. Orientation mark is indicated as follows: 

## ■ Non-latching

### G6C-□117P-US

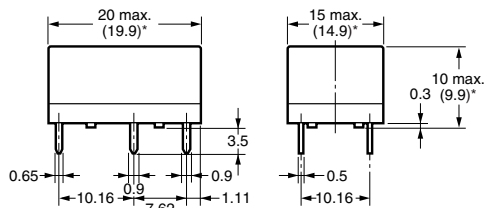
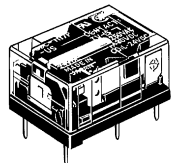

\*Average value

### G6C-1117P-US, G6C-1117C-US G6C-1114P-US, G6C-1114C-US Terminal Arrangement/Internal Connections (Bottom View)

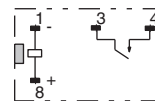

### Mounting Holes (Bottom View)

Tolerance: ±0.1

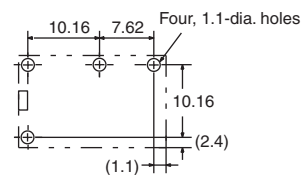

### G6C-□117C-US

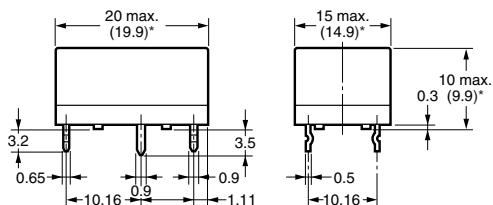
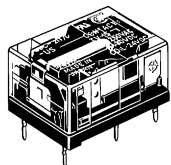

\*Average value

### G6C-□114P-US

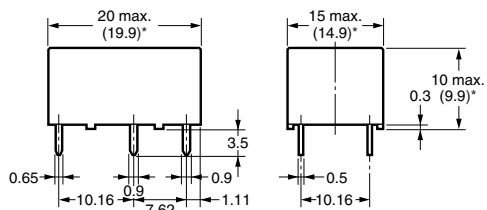
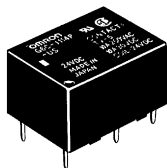

\*Average value

### G6C-2117P-US, G6C-2117C-US G6C-2114P-US, G6C-2114C-US Terminal Arrangement/Internal Connections (Bottom View)

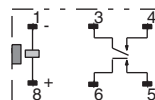

### Mounting Holes (Bottom View)

Tolerance: ±0.1

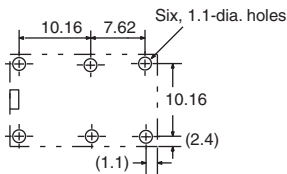

### G6C-□114C-US

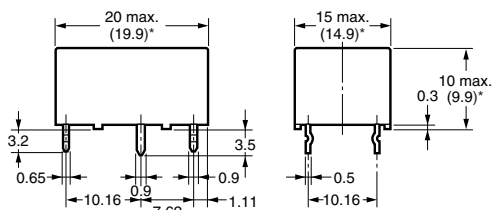
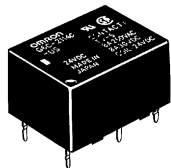

\*Average value

# Single Coil Latching

G6CU-□117P-US

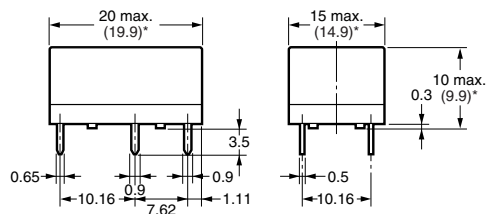
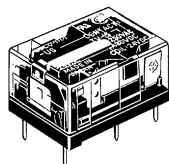

\*Average value

G6CU-1117P-US, G6CU-1117C-US  
G6CU-1114P-US, G6CU-1114C-US  
Terminal Arrangement/Internal Connections (Bottom View)

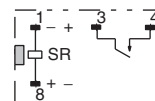

Mounting Holes (Bottom View)

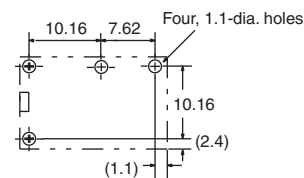

G6CU-□117C-US

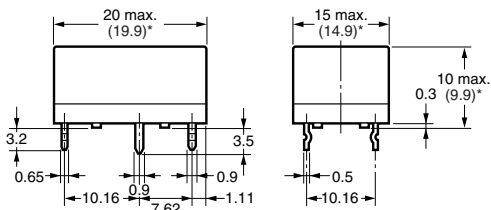
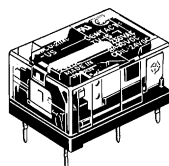

\*Average value

G6CU-□114P-US

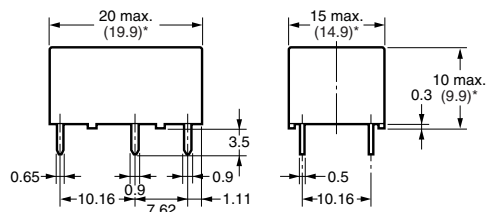
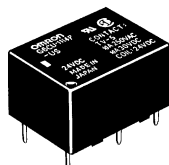

\*Average value

G6CU-2117P-US, G6CU-2117C-US  
G6CU-2114P-US, G6CU-2114C-US  
Terminal Arrangement/Internal Connections (Bottom View)

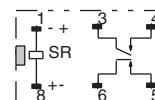

Mounting Holes (Bottom View)

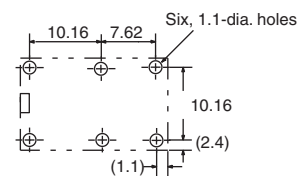

G6CU-□114C-US

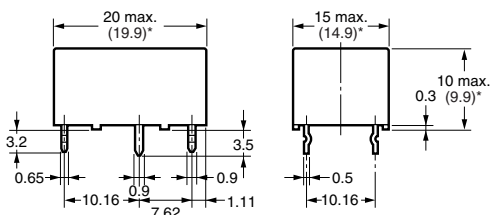
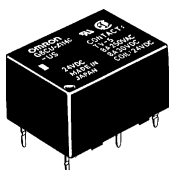

\*Average value

# ■ Dual Coil Latching

## G6CK-□117P-US

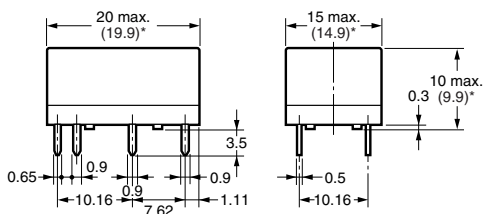
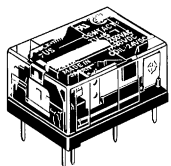

\*Average value

## G6CK-1117P-US, G6CK-1117C-US G6CK-1114P-US, G6CK-1114C-US Terminal Arrangement/Internal Connections (Bottom View)

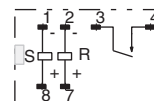

## Mounting Holes (Bottom View)

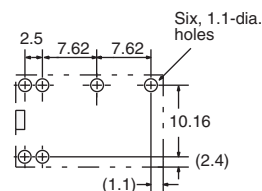

## G6CK-□117C-US

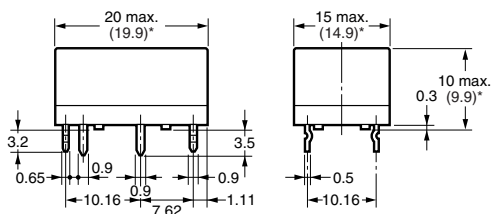
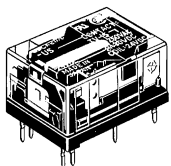

\*Average value

## G6CK-□114P-US

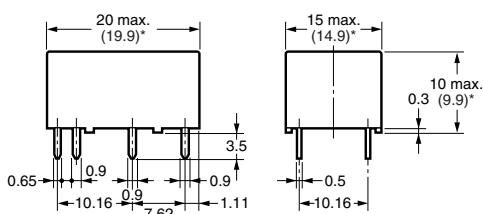
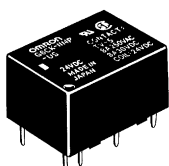

\*Average value

## G6CK-2117P-US, G6CK-2117C-US G6CK-2114P-US, G6CK-2114C-US Terminal Arrangement/Internal Connections (Bottom View)

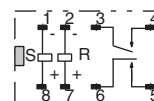

## G6CK-□114C-US

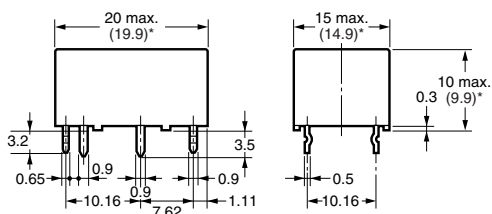
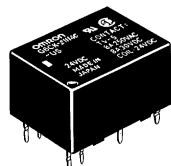

\*Average value

## Mounting Holes (Bottom View)

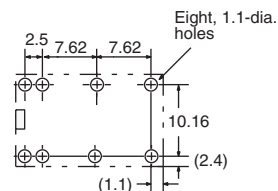



## Accessories

### Back Connecting Sockets

P6C-06P

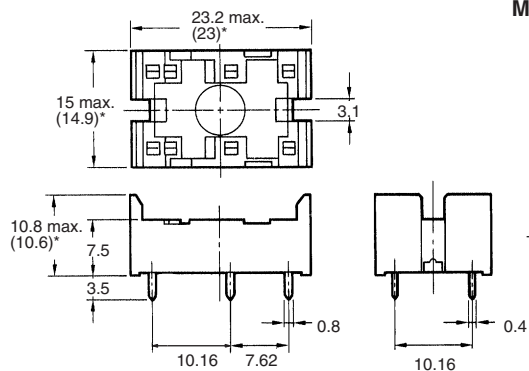
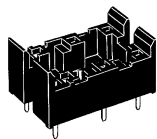

### Mounting Holes (Bottom View)

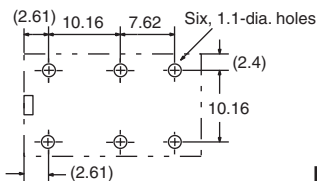

### Mounting Height of Relay with Connecting Socket

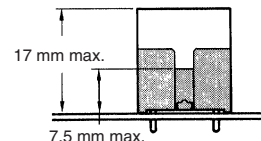

\*Average value

P6C-08P

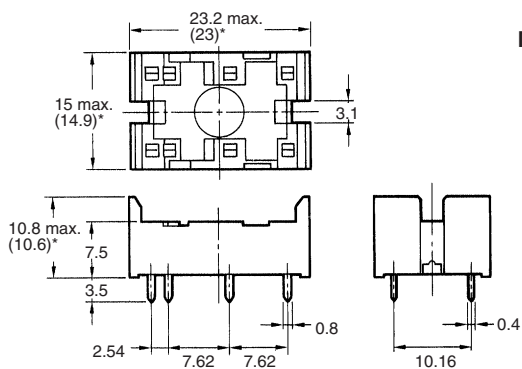
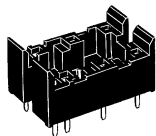

### Mounting Holes (Bottom View)

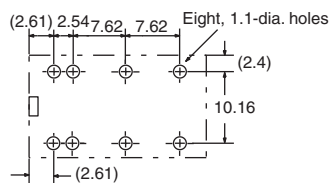

\*Average value

Note: Rated current of socket max. 5 A

### Removal Tool

P6B-Y1

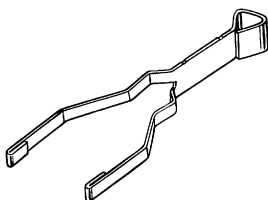

### Hold-down Clips

P6B-C2

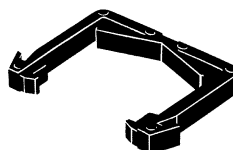

All sales are subject to Omron Electronic Components LLC standard terms and conditions of sale, which can be found at [http://www.components.omron.com/components/web/webfiles.nsf/sales\\_terms.html](http://www.components.omron.com/components/web/webfiles.nsf/sales_terms.html)

**ALL DIMENSIONS SHOWN ARE IN MILLIMETERS.**

To convert millimeters into inches, multiply by 0.03937. To convert grams into ounces, multiply by 0.03527.

---

**OMRON**<sup>®</sup>

**OMRON ELECTRONIC  
COMPONENTS LLC**

55 E. Commerce Drive, Suite B  
Schaumburg, IL 60173

**847-882-2288**

**OMRON ON-LINE**

Global - <http://www.omron.com>

USA - <http://www.components.omron.com>

Cat. No. X301-E-1b

09/11

Specifications subject to change without notice

Printed in USA