

MOS FET Relays

Technical Information

Introduction

New models with a wider range of characteristics provide an array of solutions, meeting the needs of today's high performance applications.

Our expanded range of MOS FET relays, Type G3VM, sets the benchmark in Solid State Relays (SSRs). Products are manufactured using the latest advances in automated production and include a variety of improved construction technologies within the areas of the input LED, PDA (Photo Diode Array used as a photocoupler) and MOS FET chips used in the load switching circuit. As a result, further reductions in package size and power requirements have been achieved.

Combining the advantages of mechanical and solid state technology, the new G3VM range gives you unprecedented capability to design. All models featured include a double MOS FET load circuit, enabling the designer complete versatility since it makes no difference whether an AC or DC load in either direction is connected (Connection A). Thus, the MOS FET relay is a fully functional alternative to an electromechanical relay with minimal additional drive circuitry.

The built-in Current Limit Function (CLR models) has many uses. Traditionally used to clamp excessive over current fault conditions in telecom equipment, this feature can also be used to good effect to resist transient and short circuit conditions.

MOS FET relays are the ideal data and telecommunication solution for line seizing, line switching, hook switching, Data Access Arrangement (DAA) function, line transformer circuit control and other feature phone functions. Central office applications require high reliability and long life. Here the G3VM is ideal for use in the areas of Subscriber Line Interfaces (SLICs) Multiplexers and Routers. In addition, Local Area Networks (LANs) and Network Termination Units (NTUs) including Set-Top Boxes (STBs) and Remote Metering Systems (RMS) can take advantage of the G3VMs' small size and low ON resistance.

Advances in performance and cost reduction enable MOS FET relays to be considered as good alternatives to Reed Relays in application areas such as security motion detectors (standard and anti-mask PIRs), and Automated Test Equipment (ATE) probe cards.

Glossary

Term	Symbol	Description
LED forward current	I_F	Rated current that can flow continuously in the forward direction of the LED
Repetitive peak LED forward current	I_{FP}	Rated current that can flow momentarily in the forward direction of the LED
LED forward current reduction rate	$<I_F/^\circ\text{C}$	Rated change of forward current flowing through the LED relative to ambient temperature above 25°C
LED reverse voltage	V_R	Rated reverse voltage that can be applied between the anode and the cathode
Connection temperature	T_J	Rated temperature that can be allowed in the junction of the LED, Photodetector or MOS FET(s)
Load voltage (AC peak / DC)	V_{OFF}	Rated voltage that can be applied between the MOS FET's output terminals in the OFF state
Continuous load current	I_O	Rated current that can flow between the MOS FET's output terminals in the ON state
ON current reduction rate	$<I_{ON}/^\circ\text{C}$	Rated change of load current flowing between MOS FET(s) output terminals relative to ambient temperature above 25°C
Dielectric strength between input and output	V_{I-O}	Isolation voltage between input and output terminals for a specified time
Operating temperature	T_a	Ambient temperature range in which the relay may be operated without impairment
Storage temperature	T_{stg}	Ambient temperature range in which the relay may be stored while not operating
LED forward voltage	V_F	Voltage drop between the LED's anode and cathode at a certain forward current
LED reverse current	I_R	Leakage current flowing in the LED's reverse direction (between cathode and anode)
Capacity between (LED) terminals	C_T	Electrostatic capacitance between the anode and the cathode terminals of the LED
Trigger LED forward current	I_{FT}	Minimum value of input current necessary to put the output MOS FET(s) in to the ON state
Maximum resistance with output ON	R_{ON}	Resistance between the MOS FET's output terminals specified with reference to ON state current
Current leakage when the relay is open	I_{LEAK}	Leakage current flowing between the MOS FET's output terminals in the OFF state
Output Capacitance	C_{off}	Electrostatic capacitance between the output terminals in the OFF state
Capacity between I/O terminals	C_{I-O}	Electrostatic capacitance between the input and output terminals of the relay
Insulation resistance	R_{I-O}	Resistance between the input and output terminals at the specified voltage value
Turn-ON time	t_{ON}	Time required for the output waveform to change from 0 (100%) to 90 (10%) after input goes from OFF to ON state
Turn-OFF time	t_{OFF}	Time required for the output waveform to change from 0 (100%) to 90 (10%) after input goes from ON to OFF state
Recommended Load Voltage (AC peak / DC)	V_{DD}	Rated load voltage that can be applied between the MOS FET's output terminals

Precautions

WARNING
Be sure to turn OFF the power when wiring the Relay, otherwise an electric shock may be received.

WARNING
Do not touch the charged terminals of the SSR, otherwise an electric shock may be received.

CAUTION
Do not apply overvoltage or overcurrent to the I/O circuits of the SSR, otherwise the SSR may malfunction or burn.

CAUTION
Be sure to wire and solder the Relay under the proper soldering conditions, otherwise the Relay in operation may generate excessive heat and the Relay may burn.

CAUTION
Electrostatic sensitive devices. Keep in original packaging until required to use. Avoid touching device terminals. Take static handling precautions during processing.

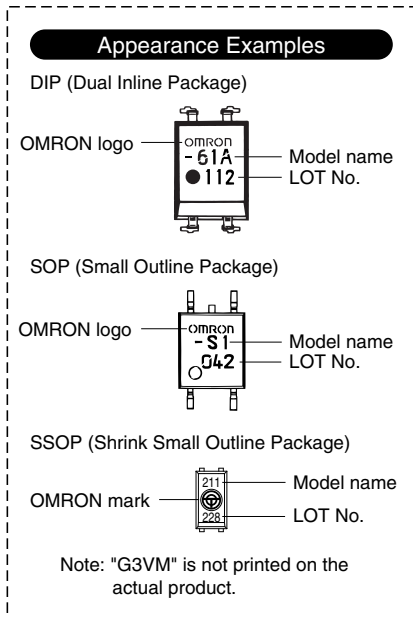

Typical Relay Driving Circuit Examples

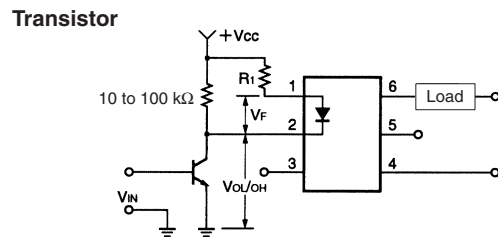
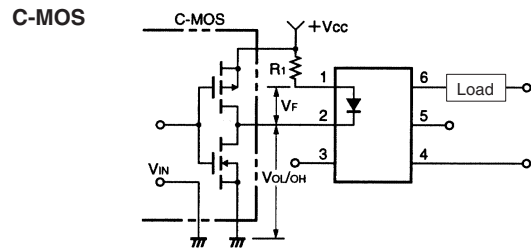

Use the following formula to obtain the LED current limiting resistance value to assure that the relay operates accurately.

$$R_1 = \frac{V_{CC} - V_{OL} - V_F (ON)}{5 \text{ to } 20 \text{ mA}}$$

Use the following formula to obtain the LED forward voltage value to assure that the relay releases accurately.

$$V_F (OFF) = V_{CC} - V_{OH} < 0.8 \text{ V}$$

Protection from Surge Voltage on the Input Terminals

If any reversed surge voltage is imposed on the input terminals, insert a diode in parallel to the input terminals as shown in the following circuit diagram and do not impose a reversed voltage value of 3 V or more.

Surge Voltage Protection Circuit Example

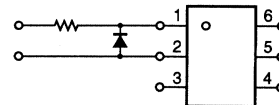

Protection from Spike Voltage on the Output Terminals

If a spike voltage exceeding the absolute maximum rated value is generated between the output terminals, insert a C-R snubber or clamping diode in parallel to the load as shown in the following circuit diagram to limit the spike voltage.

Spike Voltage Protection Circuit Example

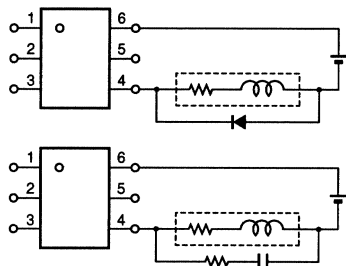

Unused Terminals (6-pin models only)

Terminal 3 is connected to the internal circuit. Do not connect anything to terminal 3 externally.

Pin Strength for Automatic Mounting

In order to maintain the characteristics of the relay, the force imposed on any pin of the relay for automatic mounting must not exceed the following.

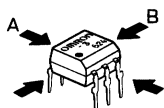

In direction A: 1.96 N
In direction B: 1.96 N

Guidelines for Mounting Devices on PCBs

Cleaning

When ions in the flux enter into the product during soldering, fluctuation in device performance or corrosion may occur. Be sure to wash away any flux residue which contains Cl⁻ or Na⁺ ions.

The following types of solvents are recommended for cleaning the flux:

- Asahi Clean AK-225AES
- Kao Cleanthru 750H
- Pine-Alpha ST-100S

Cleaning Conditions

Cleaning conditions and precautions may vary according to product specifications.

General precautions for dip cleaning

Dipping time varies according to the solvent used.

However, as a general guideline, it is recommended that the dip time be limited to three minutes.

General precautions for ultrasonic cleaning

When ultrasonic cleaning is conducted for an excessively long time, contact between the product resin and the metal leads may lessen. Also, excessive ultrasonic stress may cause cracks in the pellet.

It is recommended that the applied stress be minimized.

Load Connection

Do not short-circuit the input and output terminals while the relay is operating or the relay may malfunction.

AC Connection

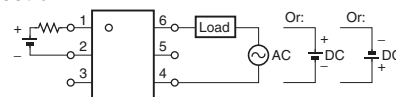

DC Single Connection

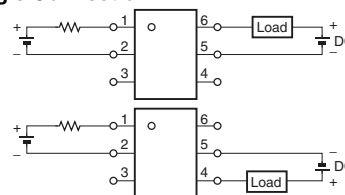

DC Parallel Connection

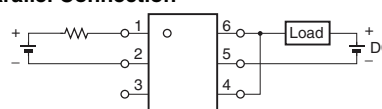

Recommended conditions for standard ultrasonic cleaning

Frequency:	27kHz to 29kHz
Output:	0.25 W/cm ² or less
Time:	30 seconds or less

Temperature: 50°C (may vary according to the type of solvent used)

Cleaning must be conducted with the printed circuit board or device floating on the solvent, so as to avoid direct contact between the PCB or device and the ultrasonic vibrator.

Handling Precautions

Do not touch the device's mark-bearing surface with your hand or with a brush while cleaning or applying cleaning liquid to the device. This may erase device markings. It is important to confirm that neither the solvent used for cleaning nor the cleaning conditions will damage the device package.

■ Solder Mounting

Perform solder mounting under the following recommended conditions to prevent the temperature of the relays from rising, causing possible damage to the relays.

Flow Soldering

Through Hole Packages (Once only)

Solder type	Preheating Temperature	Solder Temperature
Lead solder (SnPb)	150°C, 60 to 120s	260°C, 10s max.
Lead-free solder (SnAgCu)	150°C, 60 to 120s	260°C, 10s max.

Note: It is recommended that the suitability of solder mounting be verified under actual conditions

Reflow Soldering

Surface Mount Packages (Twice max.)

Solder type	Preheating Temperature*	Soldering Temperature*	
Lead solder (SnPb)	140 to 160°C, 60 to 120s	210°C, 30s max.	Peak, 240°C max.
Lead-free solder (SnAgCu)	180 to 190°C, 60 to 120s	230°C, 30 to 50s	Peak, 260°C max.

*Measured from the top surface of the relay package

Note: 1. It is recommended that the suitability of solder mounting be verified under actual conditions

2. Tape cut SSOP's are packaged without humidity resistance. Use manual soldering to mount them.

Manual Soldering (Once only)

Manually solder at 350°C for 3s or less or at 260°C for 10s or less.

SSOP Handling Precautions

Humidity-resistant Packaging

Component cases can crack if surface-mounted components that have absorbed moisture are subjected to thermal stress when mounting. To prevent this, observe the following precautions.

1. Unopened components can be stored in the packaging at 5 to 30°C and a humidity of 90% max. However, they should be used within 12 months.
2. After the packaging has been opened, components can be stored at 5 to 30°C and a humidity of 70% max. However, they should be mounted within 168 hours.
3. If, after opening the packaging, the humidity indicator turns pink to the 30% mark or the expiration date is exceeded, then bake the components while they are still on the taping reel and use them within 72 hours. Do not bake the same components more than once.
Baking conditions: 60 ± 5°C, 64 to 72 hours
4. If the same components are baked repeatedly, then the tape detachment strength will change, causing potential problems when mounting. Use caution when mounting under these conditions.
5. When mounting using dehumidifying measures, always take countermeasures against component damage from static electricity.
6. Do not throw or drop the components. If the laminated packaging material is damaged, airtightness will be lost.
7. Tape cut SSOP's are packaged without humidity resistance. Use manual soldering to mount them.

A large grid of 20 columns and 30 rows of small squares, intended for writing notes. The grid is composed of thin lines forming a uniform pattern of squares across the page.



All sales are subject to Omron Electronic Components LLC standard terms and conditions of sale, which can be found at http://www.components.omron.com/components/web/webfiles.nsf/sales_terms.html

ALL DIMENSIONS SHOWN ARE IN MILLIMETERS.
To convert millimeters into inches, multiply by 0.03937. To convert grams into ounces, multiply by 0.03527.

OMRON[®]

**OMRON ELECTRONIC
COMPONENTS LLC**

55 E. Commerce Drive, Suite B
Schaumburg, IL 60173

847-882-2288

OMRON ON-LINE

Global - <http://www.omron.com>

USA - <http://www.components.omron.com>