

## The Best Seller G2R

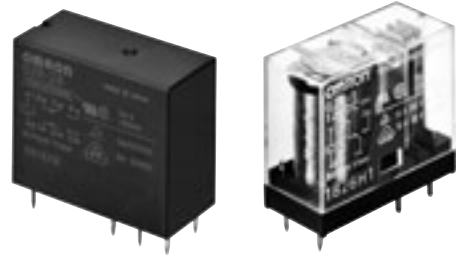

- 1 General purpose power Relays of single-pole 10 A and double-pole 5 A.
- Safety-oriented design with dielectric strength of 5,000 V between coil and contacts, and surge resistance of 10,000 V.
- AC and DC types are both available for operational coils.

RoHS Compliant



### Model Number Legend

G2R-□-□□□□-□□  
 1 2 3 4 5 6 7

#### 1. Relay Function

- None: Single-side stable
- K : Double-winding latching

#### 2. Number of poles

- 1: 1-pole
- 2: 2-pole

#### 3. Contact Form

- None: NO/NC
- A : NO

#### 4. Contact Type

- None: Single
- Z : Bifurcated contact

#### 5. Enclosure rating

- None: Flux protection (T-type is an enclosed relay)
- 4 : Fully sealed

#### 6. Terminal Shape

- None: PCB terminals
- T : Quick-connect (upper bracket mounting #187)

#### 7. Classification

- None: Standard
- E : High-capacity
- H : High-sensitivity
- U : For ultrasonically cleanable
- Z : Full-wave rectifier

G  
2  
R

### Model Configuration

Terminal Shape	Classification	Number of poles		1-pole		2-pole		Minimum packing unit
		Enclosure rating	Contact form	SPST-NO (1a)	SPDT (1c)	DPST-NO (2a)	DPDT (2c)	
PCB terminals	Standard	Flux protection	AC	G2R-1A	G2R-1	G2R-2A	G2R-2	100 pcs/tray
			DC					
		Fully sealed	AC	G2R-1A4	G2R-14	G2R-2A4	G2R-24	
			DC					
	Bifurcated contact	Flux protection	AC	G2R-1AZ	G2R-1Z	-	-	50 pcs/tray
			DC					
	Fully sealed	Flux protection	AC	G2R-1AZ4	G2R-1Z4	-	-	
			DC					
	High-capacity	Flux protection	AC	G2R-1A-E	G2R-1-E	-	-	100 pcs/tray
			DC					
High-sensitivity	Flux protection	AC	G2R-1A-H	G2R-1-H	G2R-2A-H	G2R-2-H		
		DC						
Double-winding latching	Flux protection	AC	G2RK-1A	G2RK-1	G2RK-2A	G2RK-2	50 pcs/tray	
		DC						
Quick-connect	Standard	Unsealed	AC	G2R-1A-T	G2R-1-T	-	-	100 pcs/tray
			DC					

Note 1. Full-wave rectifier and supersonic cleaner compatible models are also available. Refer to page 3.  
 2. Sockets for PCB terminal models are not provided.

## Ordering Information

### PCB Terminal Models

Classification	Enclosure rating	Number of poles Contact form	1-pole		2-pole		
			Model	Rated coil voltage	Model	Rated coil voltage	
Standard	Flux protection	NO	G2R-1A	12, 24, 100/(110) VAC	G2R-2A	12, 24, 100/(110) VAC	
				200/(220) VAC		200/(220) VAC	
				5, 6, 12, 24, 48 VDC		5, 6, 12, 24, 48 VDC	
		100 VDC	100 VDC				
		NO/NC	G2R-1	12, 24, 100/(110) VAC	G2R-2	12, 24, 100/(110) VAC	
				200/(220) VAC		200/(220) VAC	
	5, 6, 12, 24, 48 VDC			5, 6, 12, 24, 48 VDC			
	100 VDC	100 VDC					
	Fully sealed	NO	G2R-1A4	12, 24, 100/(110) VAC	G2R-2A4	12, 24, 100/(110) VAC	
				200/(220) VAC		200/(220) VAC	
				5, 6, 12, 24, 48 VDC		5, 6, 12, 24, 48 VDC	
		100 VDC	100 VDC				
NO/NC		G2R-14	12, 24, 100/(110) VAC	G2R-24	12, 24, 100/(110) VAC		
			200/(220) VAC		200/(220) VAC		
	5, 6, 12, 24, 48 VDC		5, 6, 12, 24, 48 VDC				
100 VDC	100 VDC						
High-sensitivity	Flux protection	NO	G2R-1A-H	5, 6, 12, 24, 48 VDC	G2R-2A-H	5, 6, 12, 24, 48 VDC	
		NO/NC	G2R-1-H	5, 6, 12, 24, 48 VDC	G2R-2-H	5, 6, 12, 24, 48 VDC	
		Double-winding latching	NO	G2RK-1A	5, 6, 12, 24 VDC	G2RK-2A	5, 12, 24 VDC
			NO/NC	G2RK-1	5, 6, 12, 24 VDC	G2RK-2	5, 6, 12, 24 VDC
Bifurcated contact	Flux protection	NO	G2R-1AZ	12, 24, 48 VDC	-		
				100 VDC			
		NO/NC	G2R-1Z	5, 6, 12, 24, 48 VDC			
	100 VDC						
	Fully sealed	NO	G2R-1AZ4	5, 12, 24, 48 VDC		-	
				100 VDC			
NO/NC		G2R-1Z4	5, 12, 24, 48 VDC				
100 VDC							
High-capacity	Flux protection	NO	G2R-1A-E	12, 24, 100/(110) VAC	-		
				200/(220) VAC			
				5, 6, 12, 24, 48 VDC			
				100 VDC			
		NO/NC	G2R-1-E	12, 24, 100/(110) VAC		-	
				200/(220) VAC			
				5, 6, 12, 24, 48 VDC			
				100 VDC			

Note: When ordering, add the rated coil voltage to the model number.

Example: G2R-1A AC12

Rated coil voltage

However, the notation of the coil voltage on the product case as well as on the packing will be marked as □□ VAC.

### ● Quick-connect Terminal (#187)

Classification	Enclosure rating	Number of poles Contact form	1-pole	
			Model	Rated coil voltage
Standard	Unsealed	NO	G2R-1A-T	12, 24, 100/(110) VAC
				200/(220) VAC
				5, 6, 12, 24, 48 VDC
				100 VDC
		NO/NC	G2R-1-T	12, 24, 100/(110) VAC
				200/(220) VAC
				5, 6, 12, 24, 48 VDC
				100 VDC

### ● Full-wave Rectifier

Classification	Enclosure rating	Number of poles Contact form	1-pole		2-pole	
			Model	Rated coil voltage	Model	Rated coil voltage
Standard	Flux protection	NO	G2R-1A-Z	5, 12, 24 VDC	G2R-2A-Z	5, 6, 12, 24, 48 VDC
				100 VDC		100 VDC
		NO/NC	G2R-1-Z	5, 12, 24, 48 VDC	G2R-2-Z	12, 24, 48 VDC
				100 VDC		100 VDC
	Fully sealed	NO	G2R-1A4-Z	5, 12, 48 VDC	G2R-2A4-Z	24, 48 VDC
				100 VDC		100 VDC
		NO/NC	G2R-14-Z	5, 12, 24, 48 VDC	G2R-24-Z	5, 12, 24 VDC
				100 VDC		100 VDC
High-capacity	Flux protection	NO	G2R-1A-EZ	5, 12, 24 VDC	-	
				100 VDC		
		NO/NC	G2R-1-EZ	12, 24, 48 VDC		

### ● For Ultrasonically Cleanable

Classification	Enclosure rating	Number of poles Contact form	1-pole		2-pole	
			Model	Rated coil voltage	Model	Rated coil voltage
Standard	Fully sealed	NO	G2R-1A4-U	12, 24, 100/(110) VAC	G2R-2A4-U	100/(110) VAC
				200/(220) VAC		-
				5, 6, 12, 24, 48 VDC		5, 12, 24 VDC
		NO/NC	G2R-14-U	100/(110) VAC	G2R-24-U	24, 100/(110) VAC
				200/(220) VAC		200/(220) VAC
				5, 12, 24, 48 VDC		5, 12, 24, 48 VDC
				100 VDC		100 VDC

Note: When ordering, add the rated coil voltage to the model number.

Example: G2R-1A-T AC12

Rated coil voltage

However, the notation of the coil voltage on the product case as well as on the packing will be marked as □□ VAC.

## ■ Ratings

### ● Coil

Classification	Item Rated voltage	Rated current (mA)		Coil resistance (Ω)	Must operate voltage (V)	Must release voltage (V)	Max. voltage (V)	Power consumption (VA, W)
		50 Hz	60 Hz					
<ul style="list-style-type: none"> <li>Standard</li> <li>Quick-connect</li> <li>Fully sealed</li> <li>High-capacity</li> </ul>	12 VAC	93	75	65	80% max.	30% min.	140% (at 23°C)	Approx. 0.9 (60 Hz)
	24 VAC	46.5	37.5	260				
	100/(110) VAC	11	9/(10.6)	4,600				
	200/(220) VAC	5.5	4.5/(5.3)	20,200				
<ul style="list-style-type: none"> <li>Standard</li> <li>High-capacity</li> <li>Bifurcated contact</li> <li>Quick-connect</li> <li>Fully sealed</li> </ul>	5 VDC	106		47	70% max.	15% min.	170% (at 23°C)	Approx. 0.53
	6 VDC	88.2		68				
	12 VDC	43.6		275				
	24 VDC	21.8		1,100				
	48 VDC	11.5		4,170				
<ul style="list-style-type: none"> <li>High-sensitivity</li> </ul>	5 VDC	71.4		70	70% max.	15% min.	170% (at 23°C)	Approx. 0.36
	6 VDC	60		100				
	12 VDC	30		400				
	24 VDC	15		1,600				
	48 VDC	7.5		6,400				

- Note 1. The rated current and coil resistance are measured at a coil temperature of 23°C with a tolerance of +15%/-20% (AC rated current) or ±10% (DC coil resistance).  
 Note 2. AC coil resistances shown above are only reference values.  
 Note 3. The operating characteristics are measured at a coil temperature of 23°C.  
 Note 4. The "Max. voltage" is the maximum voltage that can be applied to the relay coil.

### ● Coil: Double-winding Latching Relays

Item Rated voltage	Set Coil		Reset coil		Must set voltage (V)	Must reset voltage (V)	Max. voltage (V)	Power consumption	
	Rated current (mA)	Coil resistance (Ω)	Rated current (mA)	Coil resistance (Ω)				Set Coil (mW)	Reset coil (mW)
5 VDC	167	30	119	42	70% max.	70% max.	140% (at 23°C)	Approx. 850	Approx. 600
6 VDC	138	43.5	100	60					
12 VDC	70.6	170	50	240					
24 VDC	34.6	694	25	960					

- Note 1. The rated current and coil resistance are measured at a coil temperature of 23°C with a tolerance of ±10%.  
 Note 2. The operating characteristics are measured at a coil temperature of 23°C.  
 Note 3. The "Max. voltage" is the maximum voltage that can be applied to the relay coil.

## ● Contacts: Flux Protection Type

Classification Number of poles Load Item	Standard type Quick-connect Terminal (1 single-pole type)				High-capacity type		Bifurcated contact type		High-sensitivity type			
	1-pole		2-pole		1-pole		2-pole		1-pole		2-pole	
	Resistive load	Inductive load ( $\cos\phi = 0.4$ ; L/R = 7 ms)	Resistive load	Inductive load ( $\cos\phi = 0.4$ ; L/R = 7 ms)	Resistive load	Inductive load ( $\cos\phi = 0.4$ ; L/R = 7 ms)	Resistive load	Inductive load ( $\cos\phi = 0.4$ ; L/R = 7 ms)	Resistive load	Inductive load ( $\cos\phi = 0.4$ ; L/R = 7 ms)	Resistive load	Inductive load ( $\cos\phi = 0.4$ ; L/R = 7 ms)
Contact type	Single				Single		Bifurcated		Single			
Contact material	Ag-alloy (Cd free)											
Rated load	10 A at 250 VAC 10 A at 30 VDC	7.5 A at 250 VAC 5 A at 30 VDC	5 A at 250 VAC 5 A at 30 VDC	2 A at 250 VAC 3 A at 30 VDC	16 A at 250 VAC 16 A at 30 VDC	8 A at 250 VAC 8 A at 30 VDC	5 A at 250 VAC 5 A at 30 VDC	2 A at 250 VAC 3 A at 30 VDC	5 A at 250 VAC 5 A at 30 VDC	2 A at 250 VAC 3 A at 30 VDC	3 A at 250 VAC 3 A at 30 VDC	1 A at 250 VAC 1.5 A at 30 VDC
Rated carry current	10 A		5 A		16 A		5 A		5 A		3 A	
Max. switching voltage	380 VAC, 125 VDC				380 VAC, 125 VDC				380 VAC, 125 VDC			
Max. switching current	10 A		5 A		16 A		5 A		5 A		3 A	
Failure rate (P level) (reference value) *	100 mA at 5 VDC		10 mA at 5 VDC		100 mA at 5 VDC		1 mA at 5 VDC		100 mA at 5 VDC		10 mA at 5 VDC	

\* This value was measured at a switching frequency of 120 operations/min.

## ● Contacts: Fully Sealed Type

Classification Number of poles Load Item	Standard type (Single contact type)				Bifurcated contact type	
	1-pole		2-pole		1-pole	
	Resistive load ( $\cos\phi = 1$ )	Inductive load ( $\cos\phi = 0.4$ ; L/R = 7 ms)	Resistive load ( $\cos\phi = 1$ )	Inductive load ( $\cos\phi = 0.4$ ; L/R = 7 ms)	Resistive load ( $\cos\phi = 1$ )	Inductive load ( $\cos\phi = 0.4$ ; L/R = 7 ms)
Contact type	Single				Bifurcated	
Contact material	Ag-alloy (Cd free)					
Rated load	8 A at 250 VAC 8 A at 30 VDC	6 A at 250 VAC 4 A at 30 VDC	4 A at 250 VAC 4 A at 30 VDC	1.5 A at 250 VAC 2.5 A at 30 VDC	5 A at 250 VAC 5 A at 30 VDC	2 A at 250 VAC 3 A at 30 VDC
Rated carry current	8 A		4 A		5 A	
Max. switching voltage	380 VAC, 125 VDC				380 VAC, 125 VDC	
Max. switching current	8 A		4 A		5 A	
Failure rate (P level) (reference value) *	100 mA at 5 VDC		10 mA at 5 VDC		1 mA at 5 VDC	

\* This value was measured at a switching frequency of 120 operations/min.

## ● Contacts: Latching Type

Number of poles Load Item	1-pole		2-pole	
	Resistive load ( $\cos\phi = 1$ )	Inductive load ( $\cos\phi = 0.4$ ; L/R = 7 ms)	Resistive load ( $\cos\phi = 1$ )	Inductive load ( $\cos\phi = 0.4$ ; L/R = 7 ms)
Contact type	Single		Single	
Contact material	Ag-alloy (Cd free)			
Rated load	5 A at 250 VAC 5 A at 30 VDC	3.5 A at 250 VAC 2.5 A at 30 VDC	3 A at 250 VAC 3 A at 30 VDC	1.5 A at 250 VAC 2 A at 30 VDC
Rated carry current	5 A		3 A	
Max. switching voltage	380 VAC, 125 VDC			
Max. switching current	5 A		3 A	
Failure rate (P level) (reference value) *	100 mA at 5 VDC		10 mA at 5 VDC	

\* This value was measured at a switching frequency of 120 operations/min.

## Characteristics

### Standard Relays

Item	Number of poles	1-pole	2-pole
Contact resistance *1		30 mΩ max.	50 mΩ max.
Operate time *2		15 ms max.	
Release time *2		AC: 10 ms max.; DC: 5 ms max.	
Max. operating frequency	Mechanical	18,000 operations/hr	
	Electrical	1,800 operations/hr	
Insulation resistance *3		1,000 MΩ min.	
Dielectric strength	Between coil and contacts	5,000 VAC, 50/60 Hz for 1 min	
	Between contacts of different polarity		3,000 VAC, 50/60 Hz for 1 min
	Between contacts of the same polarity	1,000 VAC, 50/60 Hz for 1 min	
Insulation distance	Between coil and contacts	Clearance: 8 mm, Creepage: 8 mm	
Vibration resistance	Destruction	10 to 55 to 10 Hz, 0.75 mm single amplitude (1.5 mm double amplitude)	
	Malfunction	10 to 55 to 10 Hz, 0.75 mm single amplitude (1.5 mm double amplitude)	
Shock resistance	Destruction	1,000 m/s <sup>2</sup>	
	Malfunction	200 m/s <sup>2</sup> when energized; 100m/s <sup>2</sup> when no energized	
Durability	Mechanical	AC coil: 10,000,000 operations min.; DC coil: 20,000,000 operations min. (at 1,800 operations/hr)	
	Electrical	100,000 operations min. (at 1,800 operations/hr under rated load)	
Ambient operating temperature		-40°C to 70°C (with no icing)	
Ambient operating humidity		5% to 85%	
Weight		Approx. 17 g (Approx. 20 g *4)	

Note: The values here are initial values.

- \*1. Measurement conditions: 5 VDC, 1 A, voltage-drop method.
- \*2. Measurement conditions: Rated operating voltage applied, not including contact bounce.
- \*3. Measurement conditions: The insulation resistance was measured with a 500 VDC megohmmeter at the same locations as the dielectric strength was measured.
- \*4. Value for quick-connect terminals.

### Double-winding Latching Relays

Item	Number of poles	1-pole	2-pole
Contact resistance *1		30 mΩ max.	50 mΩ max.
Set	Time *2	20 ms max.	
	Min. set pulse width *3	30 ms	
Reset	Time *2	20 ms max.	
	Min. reset pulse width *3	30 ms	
Max. operating frequency	Mechanical	18,000 operations/hr	
	Electrical	1,800 operations/hr	
Insulation resistance *4		1,000 MΩ min.	
Dielectric strength	Between coil and contacts	5,000 VAC, 50/60 Hz for 1 min	
	Between contacts of different polarity		3,000 VAC, 50/60 Hz for 1 min
	Between contacts of the same polarity	1,000 VAC, 50/60 Hz for 1 min	
	Between set and reset coils	1,000 VAC, 50/60 Hz for 1 min	
Insulation distance	Between coil and contacts	Clearance: 8 mm, Creepage: 8 mm	
Vibration resistance	Destruction	10 to 55 to 10 Hz, 0.75 mm single amplitude (1.5 mm double amplitude)	
	Malfunction	10 to 55 to 10 Hz, 0.75 mm single amplitude (1.5 mm double amplitude)	
Shock resistance	Destruction	1,000 m/s <sup>2</sup>	
	Malfunction	Set: 500m/s <sup>2</sup> Armature OFF Reset: 200m/s <sup>2</sup> Contact OFF	
Durability	Mechanical	10,000,000 operations min (at 18,000 operations/hr)	
	Electrical	100,000 operations min. (at 1,800 operations/hr under rated load)	
Ambient operating temperature		-40°C to 70°C (with no icing or condensation)	
Ambient operating humidity		5% to 85%	
Weight		Approx. 17 g	

Note: The values here are initial values.

- \*1. Measurement conditions: 5 VDC, 1 A, voltage-drop method.
- \*2. Measurement conditions: Rated operating voltage applied, not including contact bounce.
- \*3. Measurement conditions: Rated operating voltage applied.
- \*4. Measurement conditions: The insulation resistance was measured with a 500 VDC megohmmeter at the same locations as the dielectric strength was measured.

## Engineering Data

### Maximum Switching Capacity

#### Flux Protection/Plug-in Relays

#### G2R-1, G2R-1A, G2R-1-T, G2R-1A-T

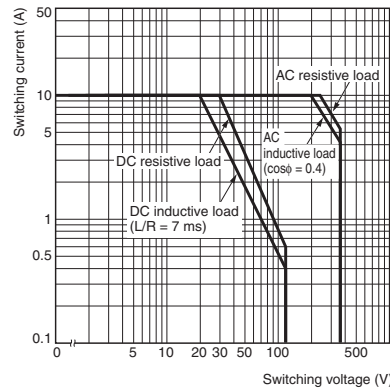

#### G2R-1-E, G2R-1A-E

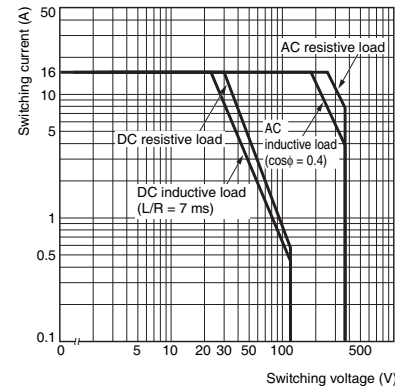

#### G2R-1Z, G2R-1AZ

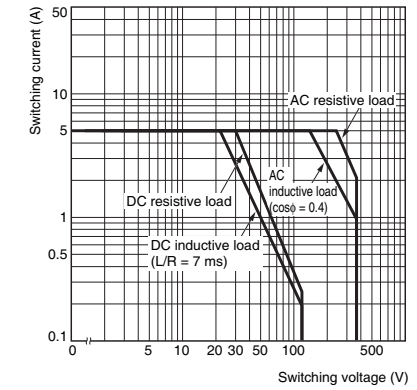

#### G2R-1-H, G2R-1A-H, G2R-2, G2R-2A

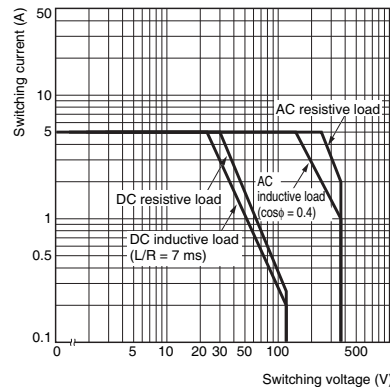

#### G2R-2-H, G2R-2A-H

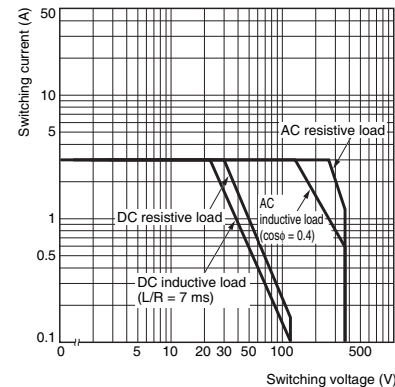

## G2RK-1A, G2RK-1



## G2RK-2A, G2RK-2



### Fully Sealed Relays

## G2R-14, G2R-1A4



## G2R-24, G2R-2A4



## G2R-1Z4, G2R-1AZ4



### ● Durability

### Flux Protection/Plug-in Relays

## G2R-1, G2R-1A, G2R-1-T, G2R-1A-T



## G2R-1-E, G2R-1A-E

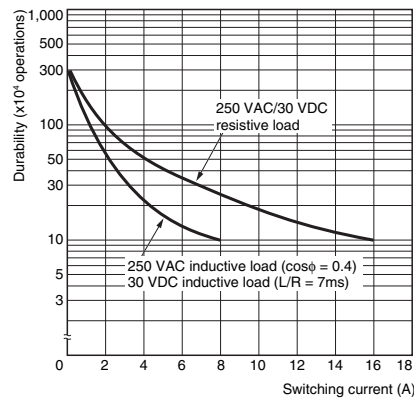

## G2R-1Z, G2R-1AZ



## G2R-1-H, G2R-1A-H, G2R-2, G2R-2A



## G2R-2-H, G2R-2A-H



## G2RK-1A, G2RK-1



## G2RK-2A, G2RK-2



### Fully Sealed Relays

## G2R-14, G2R-1A4



## G2R-24, G2R-2A4



## G2R-1Z4, G2R-1AZ4



### Ambient Temperature vs. Maximum Coil Voltage



Note: The maximum coil voltage refers to the maximum value in a varying range of operating power voltage, not a continuous voltage.

### Ambient Temperature vs. Must Operate and Must Release Voltage

#### G2R-1

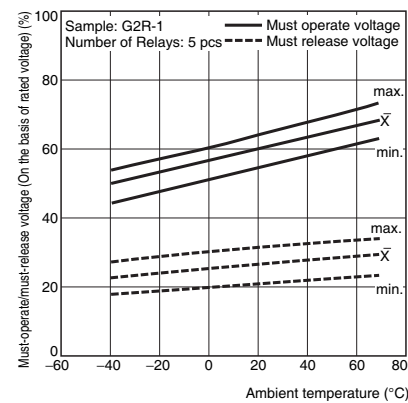

#### G2R-2

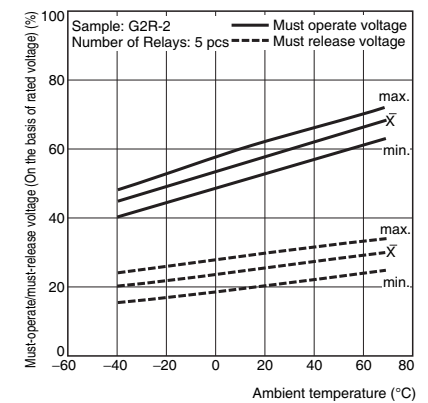

### Shock Malfunction

#### G2R-1 Number of Relays: 5 pcs

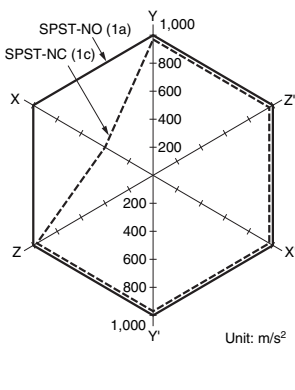

Test Conditions: Shock is applied in  $\pm X$ ,  $\pm Y$ , and  $\pm Z$  directions three times each with and without energizing the Relays to check the number of contact malfunctions. Requirement: 200 m/s<sup>2</sup> when energized; 100m/s<sup>2</sup> when de-energized

#### G2R-2 Number of Relays: 5 pcs

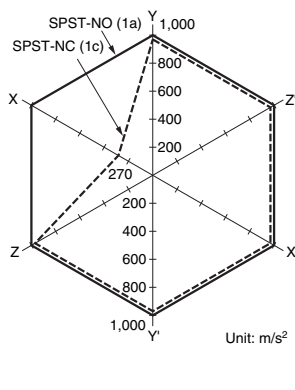

Test Conditions: Shock is applied in  $\pm X$ ,  $\pm Y$ , and  $\pm Z$  directions three times each with and without energizing the Relays to check the number of contact malfunctions. Requirement: 200 m/s<sup>2</sup> when energized; 100m/s<sup>2</sup> when de-energized

### Keep-power decrement with time

#### G2RK-1

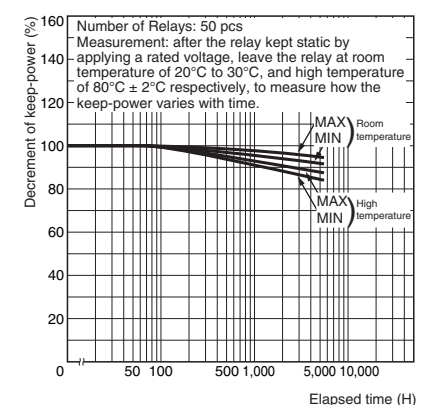



## ■ Dimensions

### Relays with PCB Terminals

#### (SPDT (1c) Relays)

#### G2R-1(-Z)

#### G2R-1Z

#### G2R-1-H



This illustration is the G2R-1 model.



#### PCB Mounting Holes (BOTTOM VIEW)

Tolerance:  $\pm 0.1$  mm

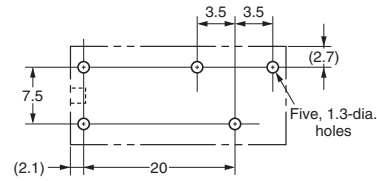

#### Terminal Arrangement/ Internal Connections (BOTTOM VIEW)

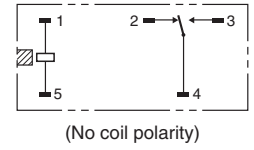

### Relays with PCB Terminals

#### (SPST-NO (1a) Relays)

#### G2R-1A(-Z)

#### G2R-1AZ

#### G2R-1A-H



This illustration is the G2R-1A model.

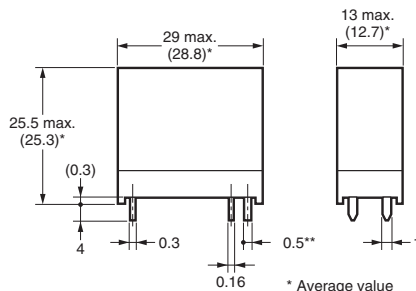

#### PCB Mounting Holes (BOTTOM VIEW)

Tolerance:  $\pm 0.1$  mm

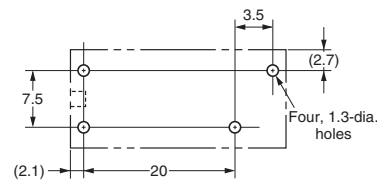

#### Terminal Arrangement/ Internal Connections (BOTTOM VIEW)



### Relays with PCB Terminals

#### (SPDT (1c) /High-capacity Relays)

#### G2R-1-E(Z)



This illustration is the G2R-1-E model.

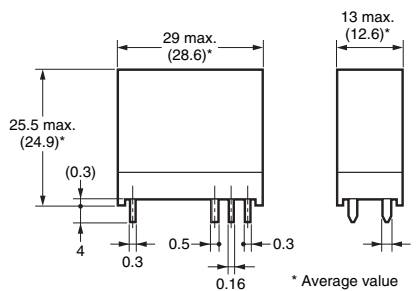

#### PCB Mounting Holes (BOTTOM VIEW)

Tolerance:  $\pm 0.1$  mm

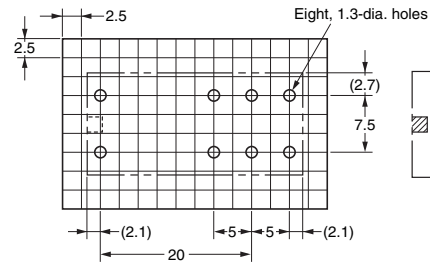

#### Terminal Arrangement/ Internal Connections (BOTTOM VIEW)

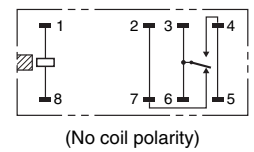

### Relays with PCB Terminals

#### (SPST-NO (1a)/High-capacity Relays)

#### G2R-1A-E(Z)



This illustration is the G2R-1A-E model.

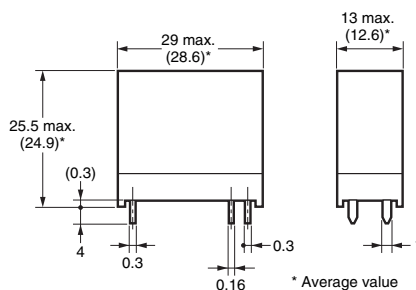

#### PCB Mounting Holes (BOTTOM VIEW)

Tolerance:  $\pm 0.1$  mm

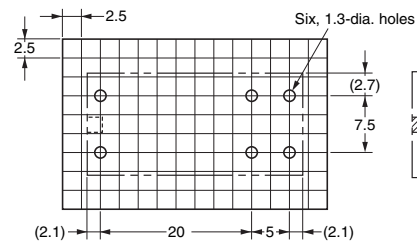

#### Terminal Arrangement/ Internal Connections (BOTTOM VIEW)



Note: Orientation marks are indicated as follows:

**Relays with PCB Terminals  
(SPDT (1c) Relays)  
G2R-14(-Z)(-U)  
G2R-1Z4**



**PCB Mounting Holes  
(BOTTOM VIEW)  
Tolerance: ±0.1 mm**

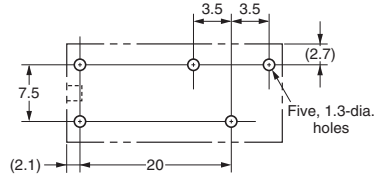

**Terminal Arrangement/  
Internal Connections  
(BOTTOM VIEW)**



**Relays with PCB Terminals  
(SPST-NO (1a) Relays)  
G2R-1A4(-Z)(-U)  
G2R-1AZ4**



**PCB Mounting Holes  
(BOTTOM VIEW)  
Tolerance: ±0.1 mm**

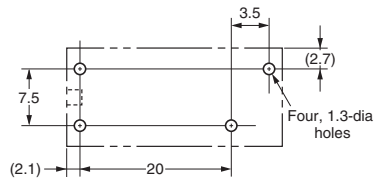

**Terminal Arrangement/  
Internal Connections  
(BOTTOM VIEW)**



**Double-winding Latching Relays with  
PCB Terminals  
(SPDT (1c) Relays)  
G2RK-1**

G2R



**PCB Mounting Holes  
(BOTTOM VIEW)  
Tolerance: ±0.1 mm**

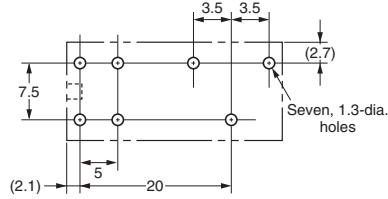

**Terminal Arrangement/  
Internal Connections  
(BOTTOM VIEW)**



**Double-winding Latching Relays with  
PCB Terminals  
(SPST-NO (1a) Relays)  
G2RK-1A**



**PCB Mounting Holes  
(BOTTOM VIEW)  
Tolerance: ±0.1 mm**

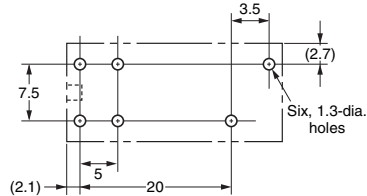

**Terminal Arrangement/  
Internal Connections  
(BOTTOM VIEW)**



**Double-winding Latching Relays with PCB Terminals  
(DPDT (2c) Relays)  
G2RK-2**

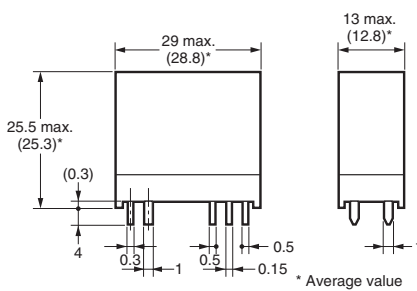

**PCB Mounting Holes  
(BOTTOM VIEW)  
Tolerance: ±0.1 mm**

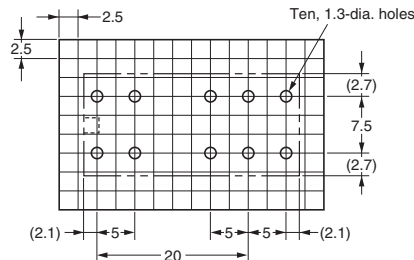

**Terminal Arrangement/  
Internal Connections  
(BOTTOM VIEW)**



**Double-winding Latching Relays with PCB Terminals  
(DPST-NO (2a) Relays)  
G2RK-2A**



**PCB Mounting Holes  
(BOTTOM VIEW)  
Tolerance: ±0.1 mm**

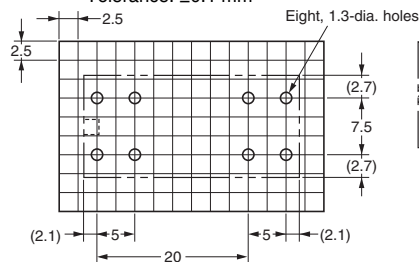

**Terminal Arrangement/  
Internal Connections  
(BOTTOM VIEW)**



Note: Orientation marks are indicated as follows: [ ] [ ]

**Relays with PCB Terminals  
(DPDT (2c) Relays)  
G2R-2(-Z)  
G2R-2-H**

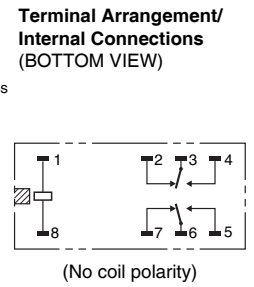
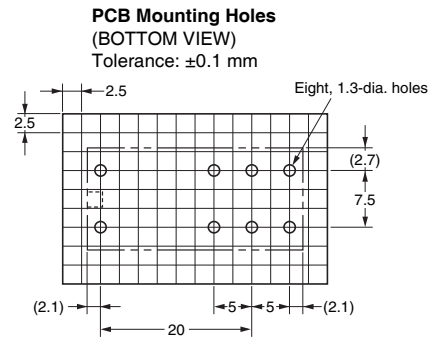
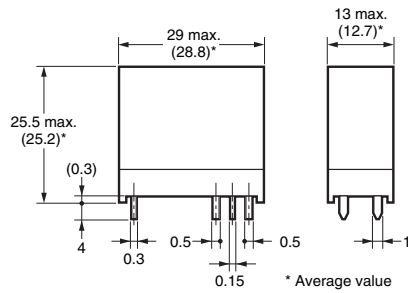

**Relays with PCB Terminals  
(DPST-NO (2a) Relays)  
G2R-2A  
G2R-2A-H  
G2R-2A-Z**

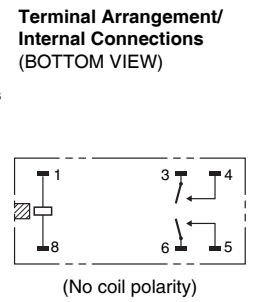
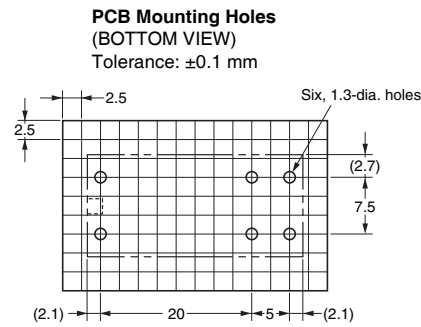
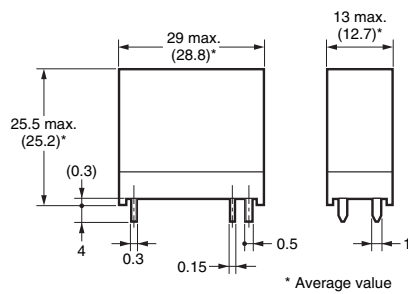

**Relays with PCB Terminals  
(DPDT (2c) Relays)  
G2R-24(-Z)(-U)**

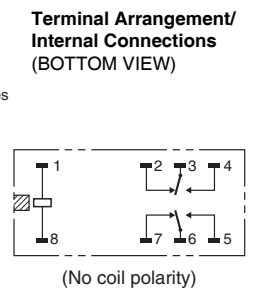
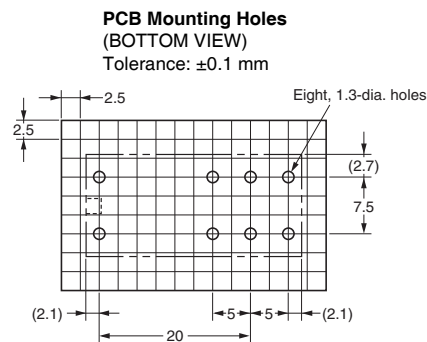
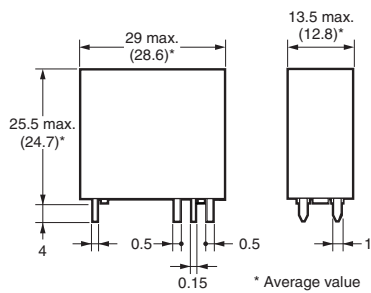
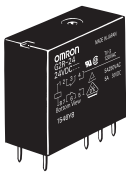

**Relays with PCB Terminals  
(DPST-NO (2a) Relays)  
G2R-2A4(-Z)(-U)**

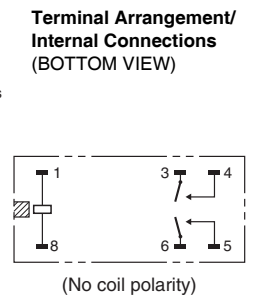
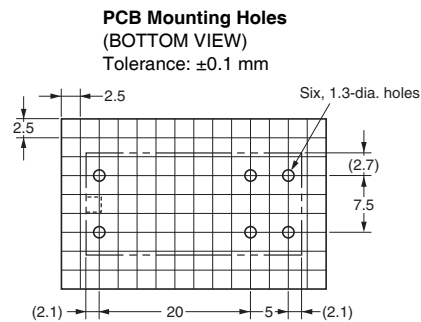
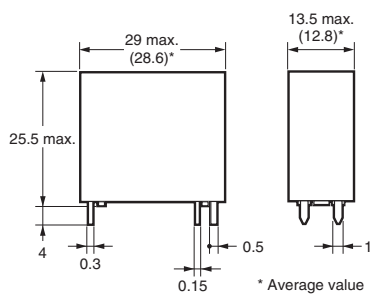

Note: Orientation marks are indicated as follows:

**Relays with Quick-connect  
Terminals  
(SPDT (1c) Relays)  
G2R-1-T**



**Mounting Holes  
(BOTTOM VIEW)**  
Tolerance:  $\pm 0.1$  mm



Note: Model number of quick-connect terminal is 187.

**Terminal Arrangement/  
Internal Connections  
(BOTTOM VIEW)**



**Relays with Quick-connect  
Terminals  
(SPST-NO (1a) Relays)  
G2R-1A-T**



**Mounting Holes  
(BOTTOM VIEW)**  
Tolerance:  $\pm 0.1$  mm

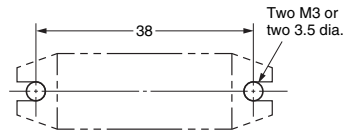

Note: Model number of quick-connect terminal is 187.

**Terminal Arrangement/  
Internal Connections  
(BOTTOM VIEW)**



G2R

Note: Orientation marks are indicated as follows:

## Approved Standards

- The approval rating values for overseas standards are different from the performance values determined individually. Confirm the values before use.

**UL Recognized:**  File No. E41643

### 1-pole

Model	Contact form	Coil ratings	Contact ratings	Number of test operations	
G2R-1A	SPST-NO (1a)	5 to 110 VDC 12 to 220 VAC	10 A, 250 VAC (General Use) at 40°C	100,000	
G2R-1A4			5 A, 277 VAC (General Use) at 40°C	6,000	
G2R-1A-H			5 A, 30 VDC (Resistive) at 40°C	100,000	
G2R-1A-T					
G2R-1	SPDT (1c)	5 to 110 VDC 12 to 220 VAC	5 A, 30 VDC (Resistive) at 40°C	100,000	
G2R-14			TV-3 (N. O. only) at 40°C	25,000	
G2R-1-H					
G2R-1-T					
G2R-1AZ	SPST-NO (1a)	5 to 110 VDC 12 to 220 VAC	10 A, 250 VAC (General Use) at 40°C	6,000	
G2R-1AZ4			5 A, 30 VDC (Resistive) at 40°C		
G2R-1Z			SPDT (1c)	5 A, 30 VDC (Resistive) at 40°C	30,000
G2R-1Z4					
G2R-1A-E	SPST-NO (1a)	5 to 110 VDC 12 to 220 VAC	16 A, 250 VAC (General Use) at 40°C	6,000	
G2R-1-E			SPDT (1c)		16 A, 30 VDC (Resistive) at 40°C
	TV-3 (N. O. only) at 40°C	25,000			

### 2-pole

Model	Contact form	Coil ratings	Contact ratings	Number of test operations
G2R-2A	DPST-NO (2a)	5 to 110 VDC 12 to 220 VAC	5 A, 250 VAC (General Use) at 40°C	6,000
G2R-2A4			5 A, 30 VDC (Resistive) at 40°C	100,000
G2R-2A-H				
G2R-2	DPDT (2c)	5 to 110 VDC 12 to 220 VAC	5 A, 30 VDC (Resistive) at 40°C	25,000
G2R-24			TV-3 (N. O. only) at 40°C	
G2R-24-H				

**CSA Certified:**  File No. LR31928

### 1-pole

Model	Contact form	Coil ratings	Contact ratings	Number of test operations
G2R-1A	SPST-NO (1a)	5 to 110 VDC 12 to 220 VAC	10 A, 250 VAC (General Use) at 40°C	100,000
G2R-1A4			10 A, 30 VDC (Resistive) at 40°C	
G2R-1A-H				TV-3 (N. O. only) at 40°C
G2R-1A-T				
G2R-1	SPDT (1c)	5 to 110 VDC 12 to 220 VAC	5 A, 250 VAC (General Use) at 40°C	6,000
G2R-14			5 A, 30 VDC (Resistive) at 40°C	
G2R-1-H			16 A, 250 VAC (General Use) at 40°C	6,000
G2R-1-T				
G2R-1AZ	SPST-NO (1a)	5 to 110 VDC 12 to 220 VAC	16 A, 30 VDC (Resistive) at 40°C	25,000
G2R-1AZ4				
G2R-1Z4				
G2R-1A-E	SPST-NO (1a)	5 to 110 VDC 12 to 220 VAC	16 A, 250 VAC (General Use) at 40°C	6,000
G2R-1-E			SPDT (1c)	
	TV-3 (N. O. only) at 40°C	25,000		

### 2-pole

Model	Contact form	Coil ratings	Contact ratings	Number of test operations
G2R-2A	DPST-NO (2a)	5 to 110 VDC 12 to 220 VAC	5 A, 250 VAC (General Use) at 40°C	6,000
G2R-2A4			5 A, 30 VDC (Resistive) at 40°C	100,000
G2R-2A-H				
G2R-2	DPDT (2c)	5 to 110 VDC 12 to 220 VAC	5 A, 30 VDC (Resistive) at 40°C	25,000
G2R-24			TV-3 (N. O. only) at 40°C	
G2R-24-H				

**EN/IEC, VDE Certified:**  Certificate No. 40015012

Model	Contact form	Coil ratings	Contact ratings	Number of test operations
G2R-1(A)-E	1	5, 6, 12, 24, 48, 100 VDC 12, 24, 100/110, 200/220 VAC	16 A, 250 VAC (cosφ = 1.0) at 70°C	100,000
G2R-( )	1	5, 6, 12, 24, 48, 100 VDC 12, 24, 100/110, 200/220 VAC	10 A, 250 VAC (cosφ = 1.0) at 40°C	
			10 A, 30 VDC (0 ms) at 40°C	
	2	5, 6, 12, 24, 48, 100 VDC 12, 24, 100/110, 200/220 VAC	5 A, 250 VAC (cosφ = 1.0) at 40°C	
			5 A, 30 VDC (0 ms) at 40°C	

**EN, TÜV Certified:** Registration No. R50030327

Model	Contact form	Coil ratings	Contact ratings	Number of test operations
G2R-1(A)-E	1	5 to 110 VDC 12 to 220 VAC	16 A, 250 VAC (cosφ = 1.0) at 70°C	100,000
G2R-( )	1	5 to 110 VDC 12 to 220 VAC	10 A, 250 VAC (cosφ = 1.0) at 70°C	
			10 A, 30 VDC (0 ms) at 70°C	
	2	5 to 110 VDC 12 to 220 VAC	5 A, 250 VAC (cosφ = 1.0) at 40°C	
			5 A, 30 VDC (0 ms) at 40°C	

## ■Precautions

● Please refer to “PCB Relays Common Precautions” for correct use.

### Correct Use

#### ● Mounting

- When mounting a number of relays on a PCB, be sure to provide a minimum mounting space of 5 mm between the two juxtaposed relays as shown below.



#### ● Handling

- The terminals are compatible with Faston receptacle #187 and are suitable for positive-lock mounting. Use only Faston terminals with the specified numbers. Select leads for connecting Faston receptacles with wire diameters that are within the allowable range for the load current. Do not apply excessive force to the terminals when mounting or dismantling the Faston receptacle. Also, do not insert terminals at an angle, or insert/remove multiple terminals at the same time. Be sure to insert and remove terminals carefully one at a time.

Refer to the following table for examples of positive-lock connectors made by AMP. Contact the manufacturer directly for details on connectors including availability.

Type	Receptacle terminals	Positive housing
#187 (Width 4.75)	AMP170330-1 (170324-1)	AMP172074-1 (natural color)
	AMP170331-1 (170325-1)	AMP172074-4 (yellow)
	AMP170332-1 (170326-1)	AMP172074-5 (green)
		AMP172074-6 (blue)

Note: The numbers shown in parentheses are for air-feeding.

#### ● Minimum Pulse Width of Double-winding Latching Relays

- The minimum pulse width shown in the table of characteristics are values measured under conditions of ambient temperature at 23°C with rated operating voltage imposed on coil. The Relay may not provide a satisfactory performance as its holding ability decreases depending on the operating circuit conditions and ambient temperature, or decreases due to degradation over time. In actual operation, impose to the coil a rated operating voltage with a pulse width that is suitable to the actual load, and reset the setting at least once a year, to correspond to the degradation over time.
- When using the Relay in a strong magnetic field environment, the magnetic body may be demagnetized due to the influence of environment, causing the Relay to malfunction.

Therefore, do not use the Relay in a strong magnetic field environment.

#### ● Degradation over Time of Double-winding Latching Relays Holding Ability

- If a double-winding latching Relay is used left set for an extended period, changes over time will degrade the magnetic force, and the reduction in holding ability may cause the set status to be released. This is also because of the properties of semi-hard magnetic material, and the rate of degradation over time depends on the ambient environment (e.g., temperature, humidity, vibration, and presence or absence of external magnetic fields). Perform maintenance at least once a year by resetting, applying the rated voltage again, and then setting.
- Wiring High Capacity (-E) Models**
  - High-capacity models (-E) have a structure that connects two terminals from one contact. When designing the circuit, use both terminals. If you use only one terminal, the relay may be unable to satisfy specified performance.

• Application examples provided in this document are for reference only. In actual applications, confirm equipment functions and safety before using the product.  
 • Consult your OMRON representative before using the product under conditions which are not described in the manual or applying the product to nuclear control systems, railroad systems, aviation systems, vehicles, combustion systems, medical equipment, amusement machines, safety equipment, and other systems or equipment that may have a serious influence on lives and property if used improperly. Make sure that the ratings and performance characteristics of the product provide a margin of safety for the system or equipment, and be sure to provide the system or equipment with double safety mechanisms.

Note: Do not use this document to operate the Unit.