

PCB Relay G5NB

A Slim Compact Relay with 3 A Switching Capability and 10-kV Impulse Withstand Voltage

- Max size 20.5L x 7.2 W x 15.3 W mm.
- Standard models switch up to 3 A
High-capacity models switch up to 5 A (AC loads only).
- Low power consumption (200 mW).
- Semi-sealed and sealed types available.
- UL recognized / CSA certified. VDE Approved.
- RoHS Compliant.

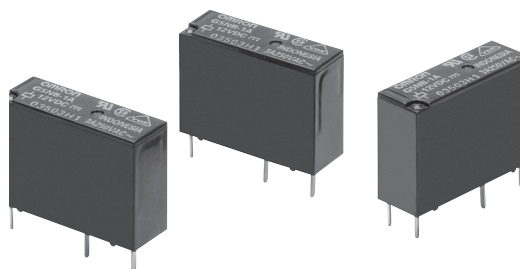

Ordering Information

Contact Form SPST-NO		
Classification	Enclosure ratings	
	Flux-tight model	Sealed model
Standard	G5NB-1A	G5NB-1A4
High Capacity	G5NB-1A-E	G5NB-1A4-E

Note: When ordering, add the rated coil voltage to the model number.

Example: G5NB-1A DC12
└─── Rated coil voltage

Example2: G5NB-1A4-E DC5
└─── Rated coil voltage

Model Number Legend

G5NB- - DC

1 2 3 4 5

1. Number of Poles

1: 1 pole

2. Contact Form

A: SPST-NO

3. Enclosure Ratings

None: Flux protection

4: Sealed

4. Type

None: Standard

E: High Capacity

5. Rated Coil Voltage

5, 12, 18, 24 VDC

Application Examples

Water heaters, refrigerators, air conditioners, and small electric appliances

Specifications

■ Coil Ratings

Rated voltage	5 VDC	12 VDC	18 VDC	24 VDC
Rated current	40.0 mA	16.7 mA	11.1 mA	8.3 mA
Coil resistance	125 Ω	720 Ω	1,620 Ω	2,880 Ω
Must operate voltage	75% of rated voltage (max.)			
Must release voltage	10% of rated voltage (min.)			
Max. voltage	Standard: 180% of rated voltage (at 23°C) High-capacity: 170% of rated voltage (at 23°C)			
Power consumption	Approx. 200 mW			

Note: 1. The rated current and coil resistance are measured at a coil temperature of 23°C with a tolerance of ±10%.

2. The operating characteristics are measured at a coil temperature of 23°C.

3. The "Max. voltage" is the maximum voltage that can be applied to the relay coil.

■ Contact Ratings

Load	Standard	High-capacity
Rated load (resistive, p.f.= 1)	3 A at 125 VAC 3 A at 30 VDC	5 A at 250 VAC 3 A at 30 VDC
Max. switching voltage	250 VAC, 30 VDC	250 VAC, 30 VDC
Rated carry current Max. switching current	3 A 3 A	5A 5A (AC load,) 3A (DC load)
Max. switching power	375 VA, 90 W	1,250 VA, 90 W

■ Characteristics

Contact resistance (see note 2)	100 mΩ max.								
Operate time	10 ms max.								
Release time	10 ms max.								
Insulation resistance (see note 3)	1,000 MΩ min. (at 500 VDC)								
Dielectric strength	4,000 VAC, 50/60 Hz for 1 min. between coil and contacts 750 VAC, 50/60 Hz for 1 min. between contacts of same polarity								
Impulse withstand voltage	10,000 V (1.2 x 50 μs) between coil and contacts								
Vibration resistance	Destruction: 10 to 55 Hz, 1.5-mm double amplitude Malfunction: 10 to 55 Hz, 1.5-mm double amplitude								
Shock resistance	Destruction: 1,000 m/s ² (approx. 100 G) Malfunction: 100 m/s ² (approx. 10 G)								
Life expectancy	Mechanical: 5,000,000 operations min. (18,000 operations/hour) Electrical: 200,000 operations minimum: <table style="margin-left: 20px;"> <tr> <td><u>High-capacity</u></td> <td><u>Standard</u></td> </tr> <tr> <td>5 A at 125 VAC</td> <td>3 A at 125 VAC</td> </tr> <tr> <td>3 A at 30 VDC</td> <td>3 A at 30 VDC</td> </tr> </table> 100,000 operations minimum: <table style="margin-left: 20px;"> <tr> <td><u>High-capacity</u></td> </tr> <tr> <td>5 A at 250 VAC</td> </tr> </table> All electrical load ratings are resistive, with operation frequency = 1,800 operations/hour.	<u>High-capacity</u>	<u>Standard</u>	5 A at 125 VAC	3 A at 125 VAC	3 A at 30 VDC	3 A at 30 VDC	<u>High-capacity</u>	5 A at 250 VAC
<u>High-capacity</u>	<u>Standard</u>								
5 A at 125 VAC	3 A at 125 VAC								
3 A at 30 VDC	3 A at 30 VDC								
<u>High-capacity</u>									
5 A at 250 VAC									
Minimum permissible load (reference value) (see note 4)	5 VDC, 10 mA								
Ambient temperature	Operating: -40°C to 70°C (with no icing or condensation)								
Ambient humidity	Operating: 5% to 85%								
Weight	Approx. 4 g								

Note: 1. The data shown above are initial value.

2. Measurement conditions: 5 VDC, 1 A, voltage drop method

3. Measurement conditions: Measured at the same points as the dielectric strength using a 500-VDC ohmmeter.

4. This value is for a switching frequency of 120 operations/minute. (P level: λ₆₀ = 0.1 x 10⁻⁶ operations)

■ Approved Standards

UL Recognized (File No. E41515)

Coil ratings	Contact ratings
5 to 24 VDC	3 A at 30 VDC (Resistive), 70°C 3 A at 125 VAC (Resistive), 70°C

CSA Certified (File No. LR31928)

Coil ratings	Contact ratings
5 to 24 VDC	3 A at 30 VDC (Resistive) 3 A at 125 VAC (Resistive)

■ Actual Load Life (Reference Values)

- 120-VAC motor and lamp load (2.5-A surge and 0.5-A normal): 250,000 operations min. (at 23°C)
- 160-VDC valve load (with varistor) (0.24-A): 250,000 operations min. (at 23°C)

Engineering Data

Standard models

Maximum Switching Capacity

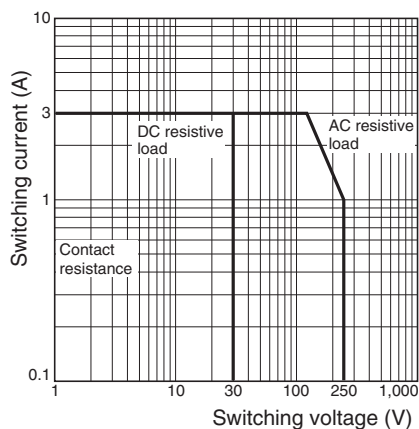

Electrical Service Life

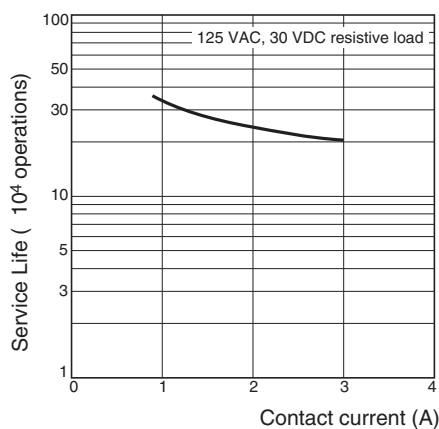

High-capacity models

Maximum Switching Capacity

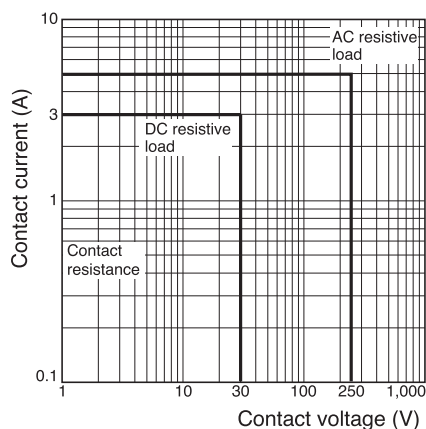

Electrical Service Life

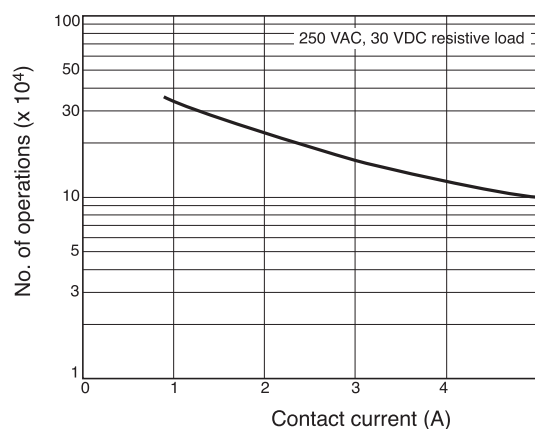

Standard models

Ambient Temperature vs. Maximum Coil Voltage

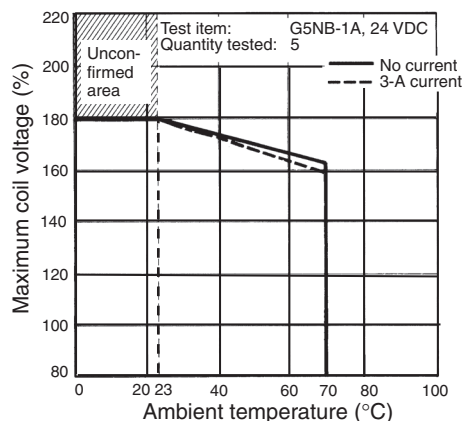

High-capacity models

Ambient Temperature vs. Maximum Coil Voltage

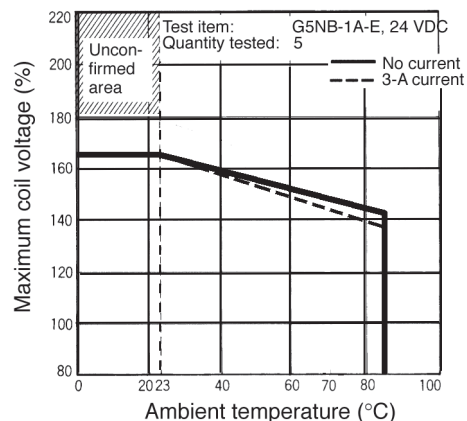

Note: The maximum coil voltage refers to the maximum value in a varying range of operating power voltage, not a continuous voltage.

All models

Malfunctioning Shock

G5NB-1A

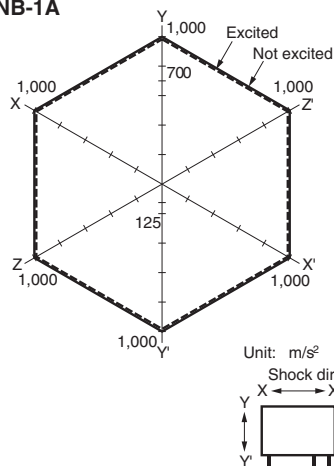

Quantity Tested: 5 units
 Test Method: Shock was applied 3 times in 6 directions along 3 axes and the level at which shock caused malfunction was measured.
 Rating: 100 m/s²

Dimensions

Note: All units are in millimeters unless otherwise indicated.

G5NB-1A(4)-(E)

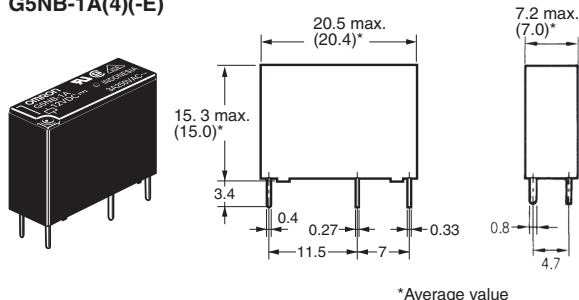

PCB Mounting Holes (Bottom View)

Tolerance: ±0.1 mm

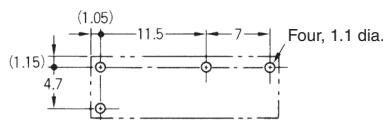

Terminal Arrangement/ Internal Connections (Bottom View)

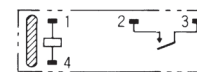

(No coil polarity)

Precautions

Correct Use

Handling

- Note: 1. The enclosure rating for G5NB-1A and G5NB-1A-E is suitable for flux protection. Do not use immersion-cleaning for these model
- 2. Do not ultrasonic clean any G5NB relay.

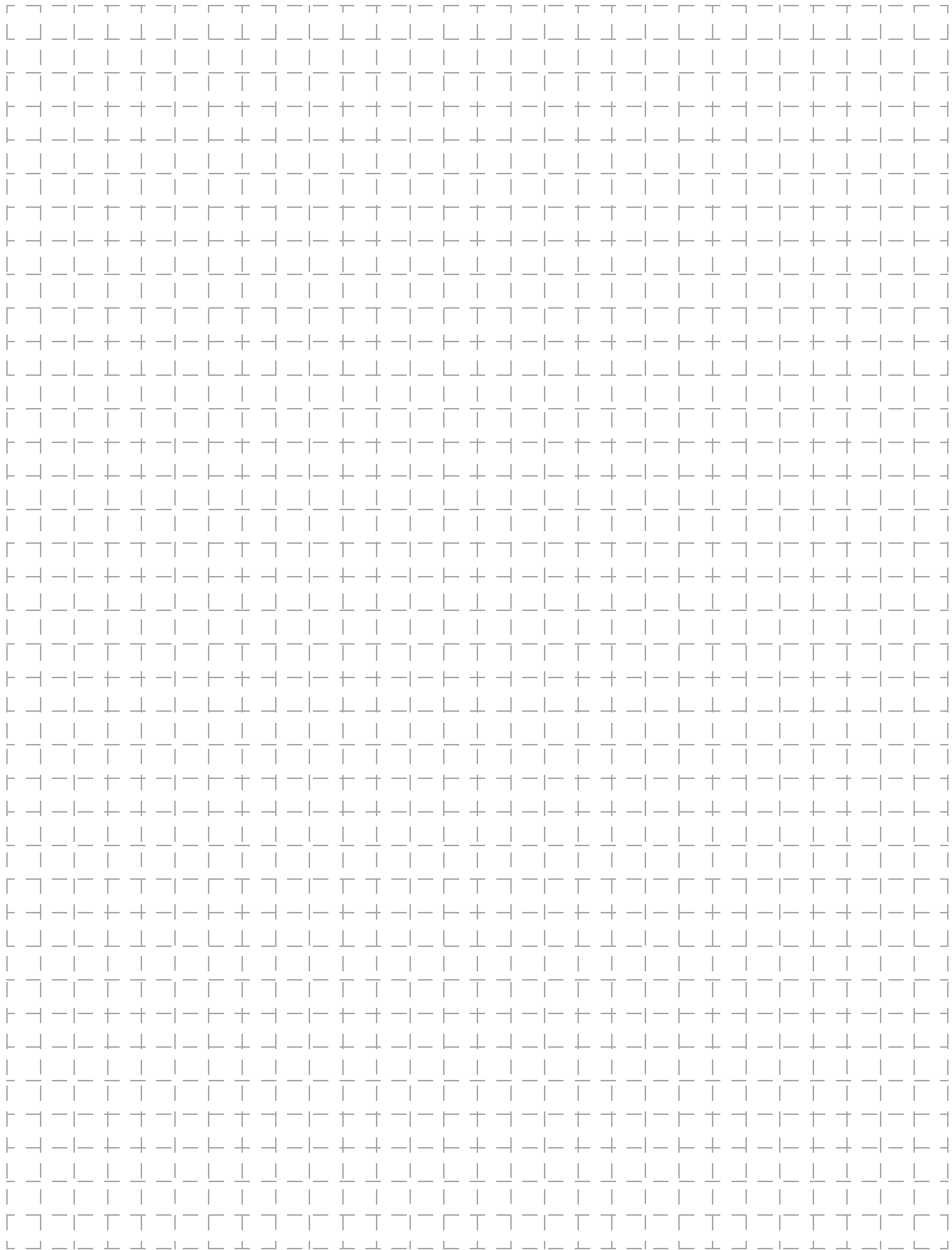

All sales are subject to Omron Electronic Components LLC standard terms and conditions of sale, which can be found at http://www.components.omron.com/components/web/webfiles.nsf/sales_terms.html

ALL DIMENSIONS SHOWN ARE IN MILLIMETERS.
To convert millimeters into inches, multiply by 0.03937. To convert grams into ounces, multiply by 0.03527.

OMRON[®]

**OMRON ELECTRONIC
COMPONENTS LLC**

55 E. Commerce Drive, Suite B
Schaumburg, IL 60173

847-882-2288

OMRON ON-LINE

Global - <http://www.omron.com>

USA - <http://www.components.omron.com>

Cat. No. X301-E-1b

09/11

Specifications subject to change without notice

Printed in USA