

Remote Reset Rocker Switch A8GS

Minimum size class in the industry Rocker switch with reset function

- Zero standby power by Reset function.
- High inrush-current durability.
Conforming to TV-8 rating. (Inrush 117A)
- Model variation for Micro loads.
- Model variation of micro load and high capacity combination. (DPST)
It is able to operate micro load and high capacity load at the same time.
- Contact gap of 3 mm minimum.
- UL and cUL standard approved, Conforming to EN standards.
- Model variation for 3.3VDC circuit.



NEW

RoHS Compliant (Please refer the Precautions)

Usage example

- Saving energy by cutting the standby power.
- Saving energy by preventing forgetting to turn OFF main power.
- Turning OFF main power by remote.
- Turning OFF main power of many equipments at the same time.

* There are 2 kinds of main models A8GS. (Delay OFF Function model and Remote Reset model) With regard to the models with Delay OFF Function, please refer to the other catalog.

List of Models

1. Reset function type

Contact Form 1 to 2: Power contact terminal a, b: Micro load contact terminal +, -: Coil terminal		SPST						Quantity per box	
		Micro load contact terminal × 1		Power contact terminal × 1					
Terminals		CT Connector		Quick-connect terminals #187 (t=0.8)		Solder terminals			
Reset voltage		5V model		3.3V model		5V model		3.3V model	
Marking on caps	No Marking	A8GS-S1105	A8GS-S1103	A8GS-P1185	A8GS-P1183	A8GS-P1115	A8GS-P1113	50	
		A8GS-S1205	A8GS-S1203	A8GS-P1285	A8GS-P1283	A8GS-P1215	A8GS-P1213		
		A8GS-S1305	A8GS-S1303	A8GS-P1385	A8GS-P1383	A8GS-P1315	A8GS-P1313		

Contact Form 1 to 2: Power contact terminal a, b: Micro load contact terminal +, -: Coil terminal		DPST				Quantity per box
		Micro load contact terminal × 1 + Power contact terminal × 1				
Terminals		Micro load contact terminal : CT Connector Power contact terminal : Quick-connect terminals #187 (t=0.8)		Micro load contact terminal : CT Connector Power contact terminal : Solder terminals		
Reset voltage		5V model		3.3V model		
Marking on caps	No Marking	A8GS-C1185	A8GS-C1183	A8GS-C1115	A8GS-C1113	50
		A8GS-C1285	A8GS-C1283	A8GS-C1215	A8GS-C1213	
		A8GS-C1385	A8GS-C1383	A8GS-C1315	A8GS-C1313	

Contact Form 1 to 4: Power contact terminal +, -: Coil terminal		DPST				Quantity per box
		Power contact terminal × 2				
Terminals		Quick-connect terminals #187 (t=0.8)		Solder terminals		50
Reset voltage		5V model	3.3V model	5V model	3.3V model	
Marking on caps		No Marking	A8GS-D1185	A8GS-D1183	A8GS-D1115	
			A8GS-D1285	A8GS-D1283	A8GS-D1215	A8GS-D1213
			A8GS-D1385	A8GS-D1383	A8GS-D1315	A8GS-D1313

Note: 1. [V] is shown at the end of model name for TV-8 approved models. (Example : A8GS-P1185V, A8GS-C1185V, A8GS-D1185V)
 Note: 2. TV-8 approved model is only for Power switch circuit.
 Note: 3. [3] is shown at the end of model name for reset voltage 3.3 VDC models. (Example : A8GS-P1183).
 [5] is shown at the end of model name for reset voltage 5 VDC models. (Example : A8GS-P1185).

2. Without Reset function type

Contact Form 1 to 4: Power contact terminal a, b: Micro load contact terminal		SPST			DPST		Quantity per box	
		Micro load contact terminal × 1	Power contact terminal × 1		Power contact terminal × 2			
		a ■ — ■ b	1 ■ — ■ 2					
Terminals		CT Connector	Quick-connect terminals #187 (t=0.8)	Solder terminals	Quick-connect terminals #187 (t=0.8)	Solder terminals	50	
Marking on caps		No Marking	A8GS-S1100	A8GS-P1180	A8GS-P1110	A8GS-D1180		A8GS-D1110
			A8GS-S1200	A8GS-P1280	A8GS-P1210	A8GS-D1280		A8GS-D1210
			A8GS-S1300	A8GS-P1380	A8GS-P1310	A8GS-D1380	A8GS-D1310	

Contact Form 1 to 2 Power contact terminal a, b: Micro load contact terminal		DPST		Quantity per box	
		Micro load contact terminal × 1 + Power contact terminal × 1			
Terminals		Micro load contact terminal : CT Connector Power contact terminal : Quick-connect terminals #187 (t=0.8)	Micro load contact terminal : CT Connector Power contact terminal : Solder terminals	50	
Marking on caps		No Marking	A8GS-C1180		A8GS-C1110
			A8GS-C1280		A8GS-C1210
			A8GS-C1380	A8GS-C1310	

Note: 4. These models are without reset function, it has same function with standard Rocker switch.

Ratings

Contact Ratings

	Rated voltage	Rated current (Resistive load)
Power contact terminal	125 VAC	16 A
	250 VAC	10 A
Micro load contact terminal	5 VDC	0.2 A

Note: 1. The above ratings were tested under the following conditions:
 (1) Ambient temperature : 20 ± 2 °C
 (2) Ambient humidity : 65 ± 5 % RH
 (3) Switching frequency : 7 times/min

Reset Coil Ratings

Model	Rated voltage, current	Operating voltage range	Rated usage cycle	Coil resistance (Coil temperature: 20 ± 2 °C)
Reset voltage : 5V model (A8GS-□□□□5)	5VDC 455 mA	4.5 to 5.5 VDC	ON: 50 to 100 ms OFF: Min 5 sec	11 Ω ± 20 %
Reset voltage : 3.3V model (A8GS-□□□□3)	3.3VDC 300 mA	3.0 to 3.6 VDC	ON: 50 to 100 ms OFF: Min 5 sec	11 Ω ± 20 %

Note: 1. Voltage for coil should be set within operating voltage range and applied time should be within rated usage cycle. Otherwise the performance of the coil may be deteriorated.

Note: 2. In case of applying voltage within the range from 5.5 to 24 VDC to the coil, contact your OMRON sales representative.

Contact specifications

	Micro load contact	Power contact
Material	Gold alloy	Silver alloy
Contact gap	3 mm	3 mm
Minimum applicable load (Reference value) *	3 VDC 1 mA	5 VDC 200 mA

* Please refer to "Using Micro loads" in "Precautions"(P6) for more information on the minimum applicable load.

Characteristics

Permissible operating frequency	Mechanical	Switch operation: 20 times/min max, Coil operation: 7 times/min max
	Electrical	7 times/min max
Insulation resistance		100 MΩ min (at 500 VDC with insulation tester)
Contact resistance (initial value)	Power contact terminal	100 mΩ max (6 VDC to 8 V, 1 A Voltage drop method)
	Micro load contact terminal	100 mΩ max (6 VDC to 8 V, 0.1 A Voltage drop method)
Dielectric strength	Between terminals of the same polarity	AC2,000 V 50/60 Hz 1 min
	Between terminals of the different polarity	AC2,000 V 50/60 Hz 1 min
	Between each terminals of the switch and terminals of coil	AC4,000 V 50/60 Hz 1 min
	Between each terminals of switch and ground	AC4,000 V 50/60 Hz 1 min
Vibration resistance *	Malfunction	10 to 55 Hz 1.5 mm double amplitude (Malfunction within 1 ms)
Shock resistance *	Malfunction	300 m/s ² min (Malfunction within 1 ms)
	Destruction	1000 m/s ² max
Ambient operating temperature		-10 to +55 °C (with no icing or condensation, 60 % RH max)
Ambient operating humidity		90 %RH max (+5 to 35 °C with no icing or condensation)
Durability	Mechanical	Switch operation: 30,000 operations min, Coil operation: 10,000 operations min
	Electrical	Switch operation: 10,000 operations min
Inrush current		117 A max.
Degree of protection		IEC IP40
Contact release time **		100 ms max
Weight		A8GS-Sxxxx: around 9 g A8GS-Pxxxx: around 10 g A8GS-Cxxxx: around 11 g A8GS-Dxxxx: around 12 g

Note: 1. Above specification values are initial values.

*For the testing condition in individual specification, contact your OMRON sales representative.

**Time from voltage applied to reset coil to actual contacts opening.

Approved Safety Standards

UL (UL61058-1)

	Approved safety standards ratings	TV-8 approved ratings *
Power contact terminal	16 A 125 VAC	TV-8
	10 A 250 VAC	
Micro load contact terminal	-	-

TÜV (EN61058-1)

	Approved safety standards ratings	TV-8 approved ratings *
Power contact terminal	10 (4) A 250 VAC	8/128 A 250 VAC
Micro load contact terminal	0.2 A 5 VDC	0.2 A 5 VDC

Note: 1. Approved safety standard ratings for Signal Switch Circuit is only for 'A8GS-Cxxxx' model. 'A8GS-Sxxxx' model is not approved.

*These ratings are only for TV-8 rating approved models.

Connector for Signal Switch Circuit and Coil Circuit

CT connectors produced by Tyco Electronics Corporation or XR connectors produced by JST shall be used for connection of Signal and Coil circuit. Other connectors shall not be used.

	Connector Terminal no.	Connection with Switch	Tyco Electronics Corporation: CT connector				JST: XR Connector	
			Housing	Pressure welding type		Cramping type		
				AWG #30-26	AWG #26-22	AWG #28-26		AWG #24
Micro load contact terminal	1	a (Switch COM)	179228-3	179609-1	179227-1	173977-3	2-179694-3	03XR-6□-P*
	2	---						
	3	b (Switch NO)						
Coil terminal	1	+ (Coil)	179228-2			173977-2	2-179694-2	02XR-6□-P*
	2	- (Coil)						

* □ indicates Housing color.

A8GS

Operation

Remote Reset Function

Button is operated for turning OFF of Power and Micro load contact terminal by applying external signal to coil.

Manual Operation

Power and Micro load contact terminal are operated to turn ON/OFF by manual, same as standard Rocker switch.

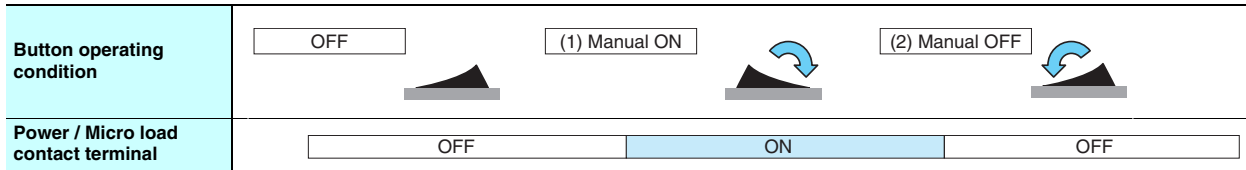

Remote Reset Function Operation

It is able to turn OFF Power and Micro load contact terminal from manual ON condition by applying voltage to coil.

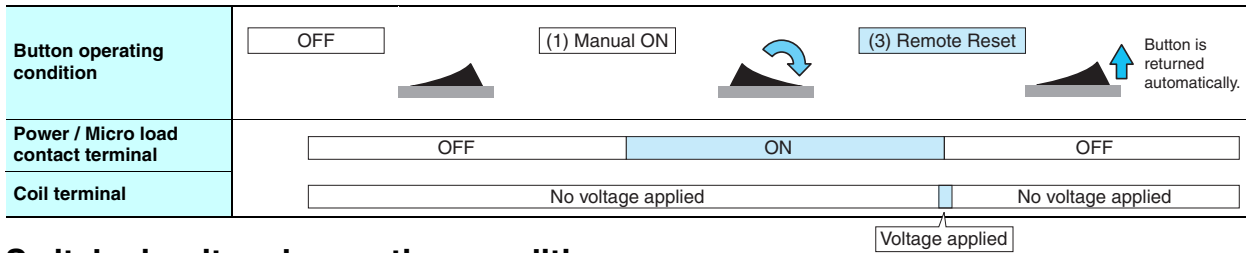

Switch circuit and operating condition

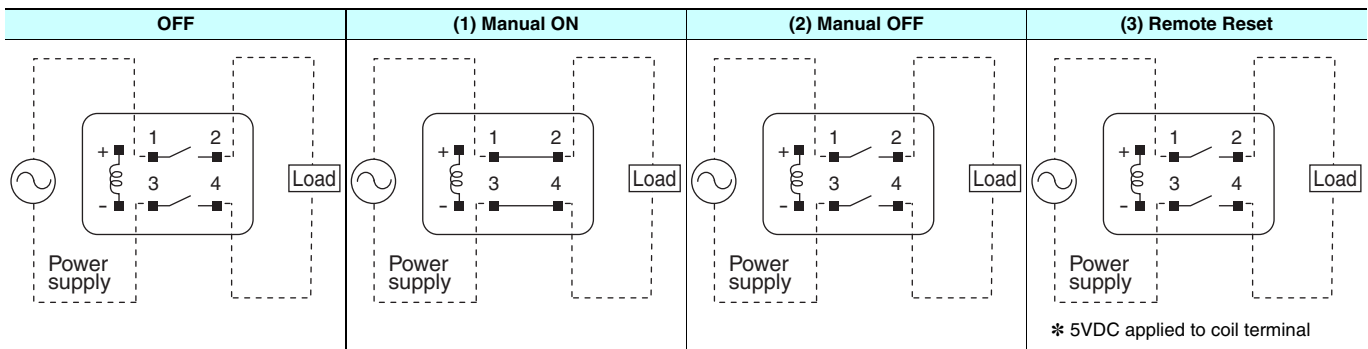

Note: 1. The above circuit is referring to the 'A8GS-Dxxxx' model.

A8GS

Panel Cutout

Panel thickness: 0.8 to 2.3 mm

Panel cutout design is for prevention of false insertion.
Please be careful about the direction of the protrusion.

The rollover of the panel shall be on the front face.
And panel back side shall be Edge shape by processing.

Note: 1. Recommendation panel material is "SPCC", however, in case of soft material or Panel back side shape is not edge, mounting strength may down. Please check and try by actual mounting panel and set the Panel thickness and hole dimension.

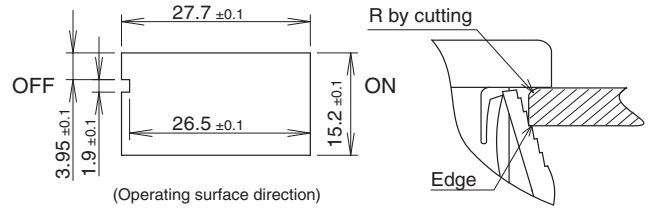

Precautions

WARNING

Do not wire the switch or touch any terminal of the Switch while power is being supplied. Or it may result in electric shock.



Cautions

Use the switch within the rated voltage and current ranges, otherwise the switch may have deteriorated durability. Radiate heat, or burn out. This particularly applies to the instantaneous voltages and currents when switching.

Caution of usage

●Mounting

- Easy to mount by snap fitting.
- Do not impose excessive force on switch at the time of panel mounting.
- Do not detach the switch after installed. Otherwise, the holding strength may be loose.
- Apply the force to housing when installing to panel. Do not apply the force to the button (rocker) part when installing to the panel.

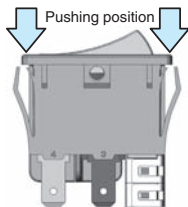

●Wiring

- Confirm the size of the receptacles and be sure to connect them firmly.
- Use an appropriate wire allowable to carry current.
- Be sure that there is no mechanical stress on terminals and coil terminals. Otherwise, the switch may malfunction and/or damaged. (Example: Too strong wiring)

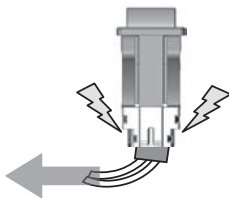

- Take appropriate insulation distance between switch terminal and other metal parts after wiring.
- Coil has polarity, please confirm polarity when wiring.
- Do not apply continuous voltage more than 10 seconds at any time. Otherwise, insulation deterioration may occur by heat of coil. Please consider the circuit design.
- Reverse voltage may cause of accurate discrete semiconductor devices. In case of controlling by accurate discrete semiconductor devices, Please consider the circuit design. (Example : add the surge absorbing circuit)
- In case of manual soldering, soldering time is max 4 sec by soldering iron (Max 350 °C at the iron tip) and do not add the stress to terminals.
- In case of touching the soldering iron to the root of terminals, it may cause Housing parts melt.

●Handling

- Do not apply excessive operating force to the switch.
- Do not drop or apply the excessive shock. Otherwise the switch may be damaged or deformed.
- Do not impose force to operating part from an angle, Otherwise the switch may be damaged or deformed.

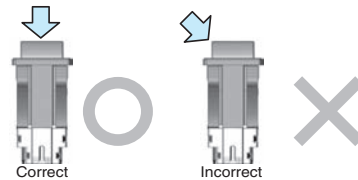

●Environment for storage and use

- To prevent the terminals color change and others while storage, Do not keep for a long term in the following conditions.
 - (1) High temperature, high humid environment
 - (2) Corrosive gas
 - (3) The place where the direct rays of the sun
 - (4) The place where the sea breeze
 - (5) Environmental with a sudden temperature change
 This switch is not sealed to prevent from entering dust and liquid. Do not use under dust and liquid condition.
- Switch shall not be icing or condensation.
- Strong magnetic field may cause malfunction. Check function is recommended under practical use conditions.

●Using Micro Loads

In case of using the switch under the micro loads, please refer the Minimum applicable load and set the load more than minimum applicable load.

Even when using micro load within the operating range, if inrush current occurs, it may increase contact wear and so deteriorate durability. Therefore, insert a contact protection circuit where necessary.

The minimum applicable load is the L-level reference value. This value indicates the malfunction reference level for the reliability level of 60 %. ($\lambda 60$)

The equation, $\lambda 60 = 0.5 \times 10^{-6} / \text{operations}$ indicates that the estimated malfunction rate is less than 1/2,000,000 operations with a reliability level of 60 %.

●RoHS Compliant

The "RoHS Compliant" designation indicates that the listed models do not contain the six hazardous substances covered by the RoHS Directive.

Reference: The following standards are used to determine compliance for the six substances.

Lead	: 1,000 ppm max.
Mercury	: 1,000 ppm max.
Cadmium	: 100 ppm max.
Hexavalent chromium	: 1,000 ppm max.
PBB	: 1,000 ppm max.
PBDE	: 1,000 ppm max.

- Application examples provided in this document are for reference only. In actual applications, confirm equipment functions and safety before using the product.
- Consult your OMRON representative before using the product under conditions which are not described in the manual or applying the product to nuclear control systems, railroad systems, aviation systems, vehicles, combustion systems, medical equipment, amusement machines, safety equipment, and other systems or equipment that may have a serious influence on lives and property if used improperly. Make sure that the ratings and performance characteristics of the product provide a margin of safety for the system or equipment, and be sure to provide the system or equipment with double safety mechanisms.

Note: Do not use this document to operate the Unit.

OMRON Corporation
Electronic and Mechanical Components Company

Contact: www.omron.com/ecb

CSM_3_1_1216
Cat. No. A222-E1-03
1014(0313)(O)