

Rotary DIP Switch

A6K/A6KS

Miniature (7.2 × 7.2mm size) Rotary DIP Switch

- Mounting space reduced by 50%.
(compared with conventional models)
- SMT and through hole type Available.
Side-actuated type available.
- Gold-plated contacts ensure high reliability.

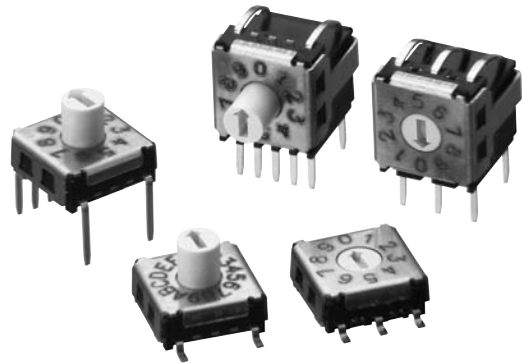

RoHS Compliant

Application

Mode setting of MPU
Modem
Controller of servo motor
Coin changer
Program controller

List of Models

● Through hole (3 × 3 Terminal)

Type (actuator color)			Top-actuated, flat (White)	Top-actuated, extended actuator (White)	Side-actuated, flat (White)	Side-actuated, extended actuator (White)
No. of switching positions	Quantity per tube	Output code				
		10	BCD Decimal	A6K-102RF	A6K-102RS	A6KV-102RF
16	Top :63 Side:60	BCD Hexadecimal	A6K-162RF	A6K-162RS	A6KV-162RF	A6KV-162RS



● Through hole (5 × 2 Terminal)

Type (actuator color)			Top-actuated, flat (White)	Top-actuated, extended actuator (White)	Side-actuated, flat (White)	Side-actuated, extended actuator (White)
No. of switching positions	Quantity per tube	Output code				
		10	BCD Decimal	A6K-104RF	A6K-104RS	A6KV-104RF
16	Top :63 Side:60	BCD Hexadecimal	A6K-164RF	A6K-164RS	A6KV-164RF	A6KV-164RS

● SMT (3 × 3 Terminal, Tube)

Type (actuator color)			Top-actuated, flat (White)	Top-actuated, extended actuator (White)
No. of switching positions	Quantity per tube	Output code		
		10	BCD Decimal	A6KS-102RF
16	63	BCD Hexadecimal	A6KS-162RF	A6KS-162RS

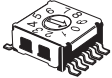
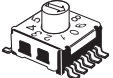

● SMT (5 × 2 Terminal, Tube)

Type (actuator color)			Top-actuated, flat (White)	Top-actuated, extended actuator (White)	Side-actuated, flat (White)	Side-actuated, extended actuator (White)	
No. of switching positions	Quantity per tube	Output code					
			10	63	BCD Decimal	A6KS-104RF	A6KS-104RS
16			BCD Hexadecimal	A6KS-164RF	A6KS-164RS	A6KSV-164RF	A6KSV-164RS

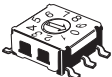
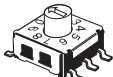
● SMT (3 × 3 Terminal, Embossed taping Packages)

Type (actuator color)		Top-actuated, flat (White)		Top-actuated, extended actuator (White)	
No. of switching positions	Output code	Minimum packing unit		Minimum packing unit	
		10	BCD Decimal	1450	A6KS-102RF-P
16	BCD Hexadecimal		A6KS-162RF-P		A6KS-162RS-P

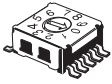
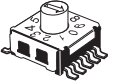
● SMT (5 × 2 Terminal, Embossed taping Packages)

Type (actuator color)		Top-actuated, flat (White)		Top-actuated, extended actuator (White)		Side-actuated, flat (White)		Side-actuated, extended actuator (White)	
No. of switching positions	Output code	Minimum packing unit		Minimum packing unit		Minimum packing unit		Minimum packing unit	
		10	BCD Decimal	1450	A6KS-104RF-P	850	A6KS-104RS-P	750	A6KSV-104RF-P
16	BCD Hexadecimal		A6KS-164RF-P		A6KS-164RS-P		A6KSV-164RF-P		A6KSV-164RS-P

Note: Order in multiples of the package quantity.

■ Ratings/Characteristics

Rating (resistive load)	25 mA at 24 VDC 10 μA (minimum current) at 3.5 VDC	
Ambient operating temperature	-30 to +80°C at 60% max. (with no icing or condensation)	
Ambient operating humidity	35% to 95% (at +5 to +35°C)	
Insulation resistance	100 MΩ min. (at 250 VDC with insulation tester)	
Contact resistance (initial value)	200 mΩ max.	
Dielectric strength	Between terminals	250 VAC for 1 min
Vibration resistance	Malfunction	10 to 55 Hz, 1.5-mm double amplitude
Shock resistance	Malfunction	300 m/s ² min.
Durability	Electrical	20,000 steps min.
Washing	Not possible	
Degree of protection	IEC IP60	
Operating torque	1.96 × 10 ⁻² N·m {2 gf·m} max.	
Weight (See note.)	Through hole terminal	Top-actuated, flat: Approx. 0.4 g, Side-actuated, flat: Approx. 0.7 g
	SMT terminal	Top-actuated, flat: Approx. 0.4 g, Side-actuated, flat: Approx. 0.4 g

Note: Add 0.03 g for the extended-actuator type of each model.

Output Codes

10-position Models

Code	BCD Decimal code			
	1	2	4	8
0				
1	●			
2		●		
3	●	●		
4			●	
5	●		●	
6		●	●	
7	●	●	●	
8				●
9	●			●

16-position Models

Code	BCD Hexadecimal code			
	1	2	4	8
0				
1	●			
2		●		
3	●	●		
4			●	
5	●		●	
6		●	●	
7	●	●	●	
8				●
9	●			●
A		●		●
B	●	●		●
C			●	●
D	●		●	●
E		●	●	●
F	●	●	●	●

Note: "●" indicates that the internal switch is ON.

Dimensions (Unit: mm)

Through hole

● Top-actuated Flat Models with 3 × 3 Terminal Arrangement

A6K-102RF
A6K-162RF

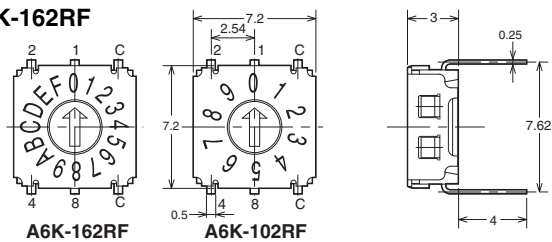

● Top-actuated Extended actuator Models with 3 × 3 Terminal Arrangement

A6K-102RS
A6K-162RS

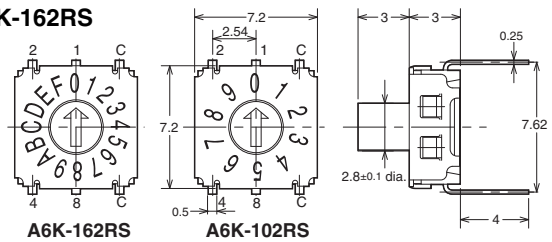

● Side-actuated Flat Models with 3 × 3 Terminal Arrangement

A6KV-102RF
A6KV-162RF

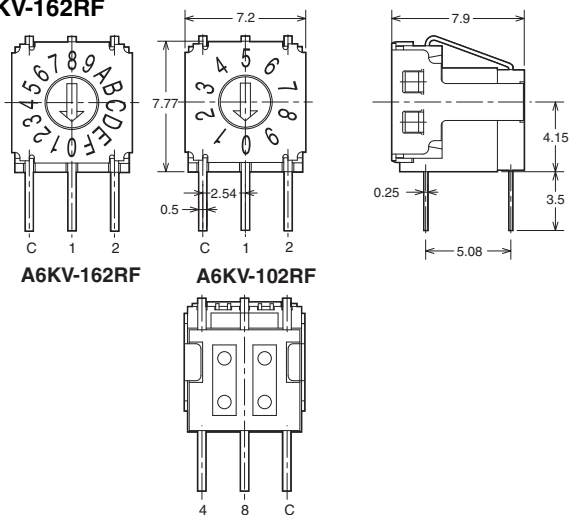

● Side-actuated Extended-actuator Models with 3 × 3 Terminal Arrangement

A6KV-102RS
A6KV-162RS

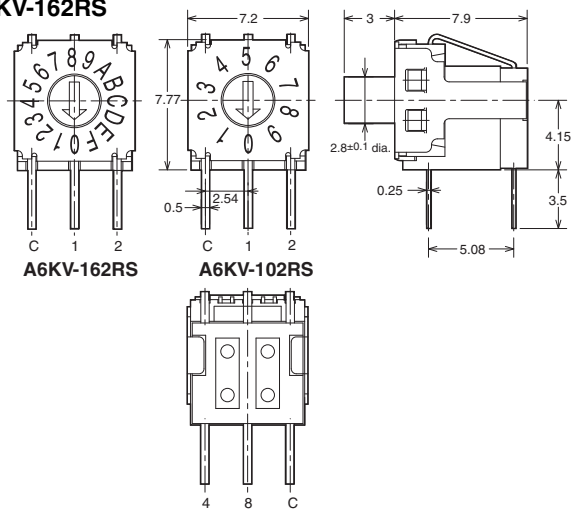

Note: Unless otherwise specified, a tolerance of ±0.4 mm applies to all dimensions.

● Top-actuated Flat Models with 5 × 2 Terminal Arrangement

A6K-104RF
A6K-164RF

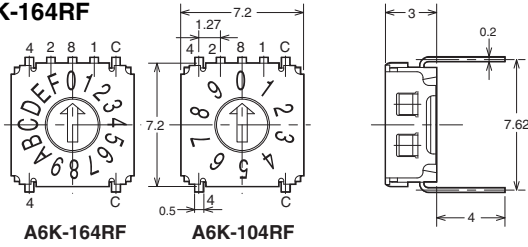

● Top-actuated Extended actuator Models with 5 × 2 Terminal Arrangement

A6K-104RS
A6K-164RS

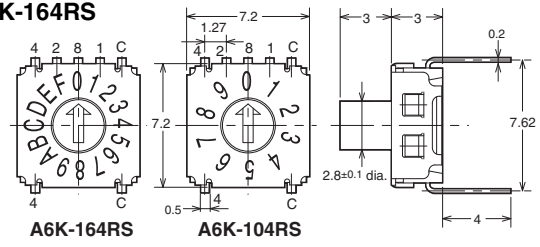

● Side-actuated Flat Models with 5 × 2 Terminal Arrangement

A6KV-104RF
A6KV-164RF

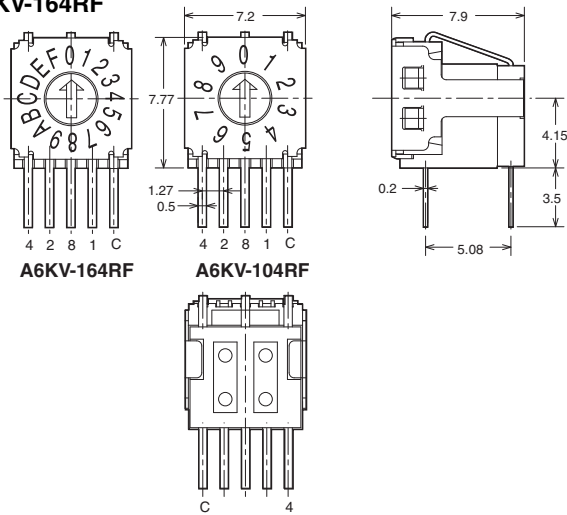

● Side-actuated Extended-actuator Models with 5 × 2 Terminal Arrangement

A6KV-104RS
A6KV-164RS

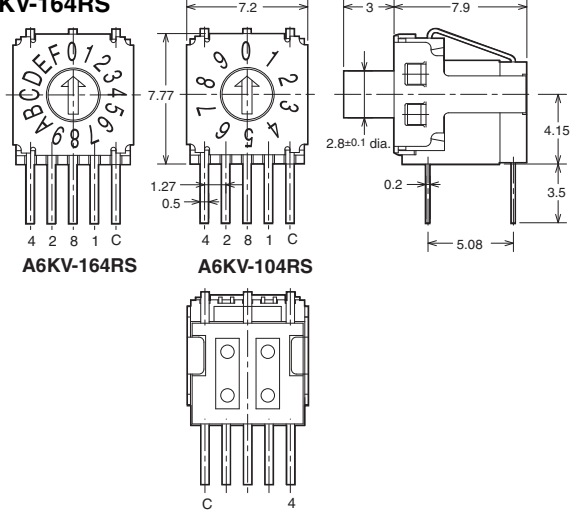

SMT

● Top-actuated Flat Models with 3 × 3 Terminal Arrangement

A6KS-102RF
A6KS-162RF

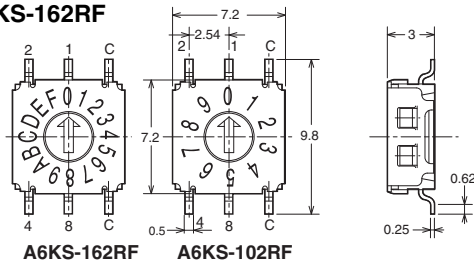

● Top-actuated Extended actuator Models with 3 × 3 Terminal Arrangement

A6KS-102RS
A6KS-162RS

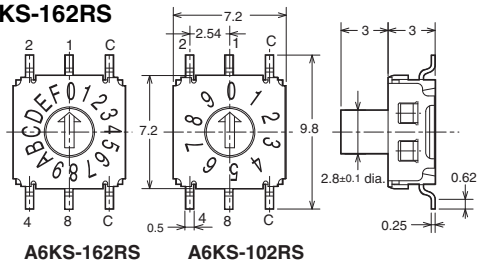

● Top-actuated Flat Models With 5 × 2 Terminal Arrangement

A6KS-104RF
A6KS-164RF

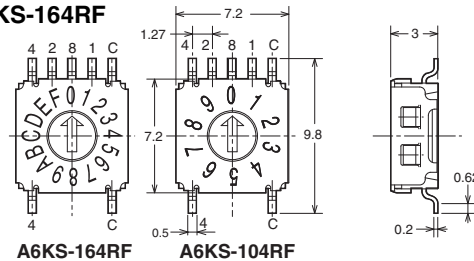

● Top-actuated Extended actuator Models with 5 × 2 Terminal Arrangement

A6KS-104RS
A6KS-164RS

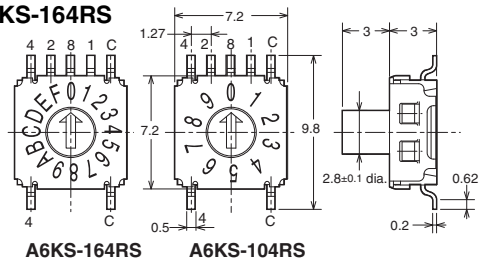

Note: Unless otherwise specified, a tolerance of ±0.4 mm applies to all dimensions.

● Side-actuated Flat Models with 5 × 2 Terminal Arrangement

A6KSV-104RF
A6KSV-164RF

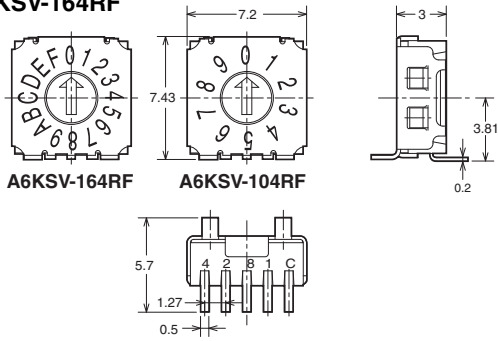

● Side-actuated Extended-actuator Models with 5 × 2 Terminal Arrangement

A6KSV-104RS
A6KSV-164RS

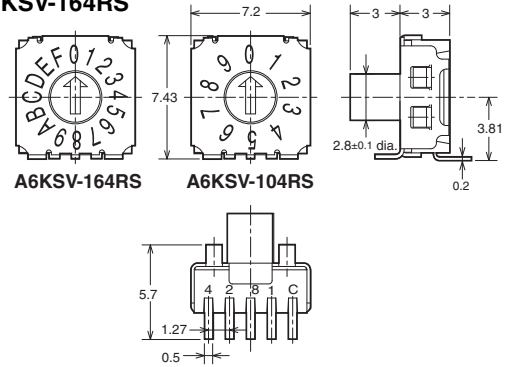

Note: Unless otherwise specified, a tolerance of ±0.4 mm applies to all dimensions.

■ PCB Dimensions (Top View) (Unit: mm)

● 3 × 3 Terminal Arrangement

Through hole (Top-actuated Models)

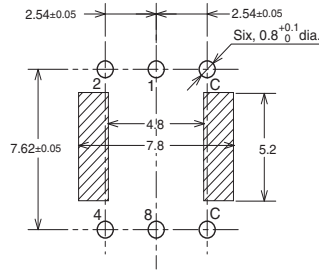

Through hole (Side-actuated Models)

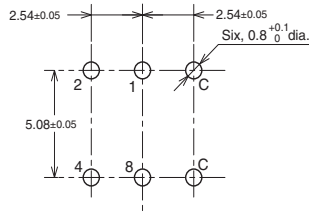

SMT (Top-actuated Models)

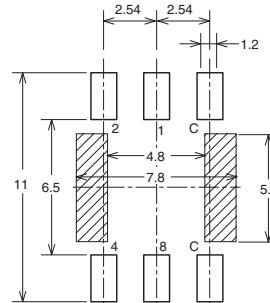

● 5 × 2 Terminal Arrangement

Through hole (Top-actuated Models)

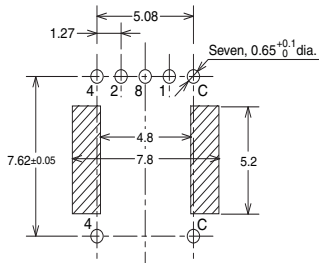

Through hole (Side-actuated Models)

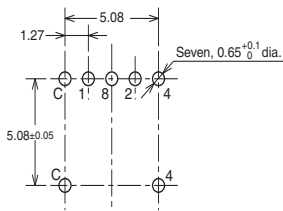

SMT (Top-actuated Models)

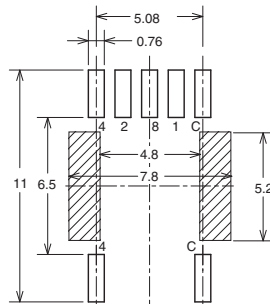

SMT (Side-actuated Models)

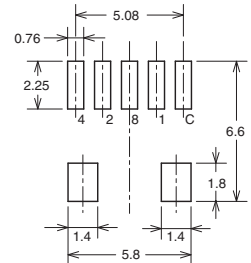

:Through hole and Pattern prohibited area

Note: Unless otherwise specified, a tolerance of ±0.4 mm applies to all dimensions.

Internal Connections

Contact Form

- **Top-actuated/Side-actuated Models with 3 × 3 Terminal Arrangement (Through hole/SMT)**

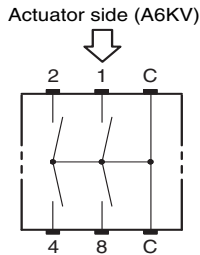

- **Top-actuated Models with 5 × 2 Terminal Arrangement (Through hole/SMT)**

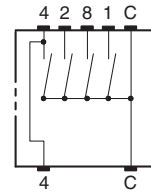

- **Side-actuated Models with 5 × 2 Terminal Arrangement (Through hole)**

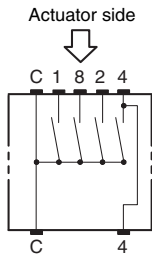

- **Side-actuated Models with 5 × 2 Terminal Arrangement (SMT)**

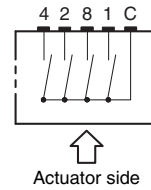

Precautions

Be sure to read the Safety precautions common to all DIP Switches for correct use.

- Application examples provided in this document are for reference only. In actual applications, confirm equipment functions and safety before using the product.
- Consult your OMRON representative before using the product under conditions which are not described in the manual or applying the product to nuclear control systems, railroad systems, aviation systems, vehicles, combustion systems, medical equipment, amusement machines, safety equipment, and other systems or equipment that may have a serious influence on lives and property if used improperly. Make sure that the ratings and performance characteristics of the product provide a margin of safety for the system or equipment, and be sure to provide the system or equipment with double safety mechanisms.

Note: Do not use this document to operate the Unit.