

Detection Switch D2X

Switch with Crimp Connector

- Reduced wiring time with AMP crimp-type connectors
- Snap-fit attachment for easy installation
- Actuator operates from either side, allowing mounting in either direction
- High contact force and wiping action for greater contact reliability
- Rated load 0.1 A at 30 VDC
- RoHS Compliant

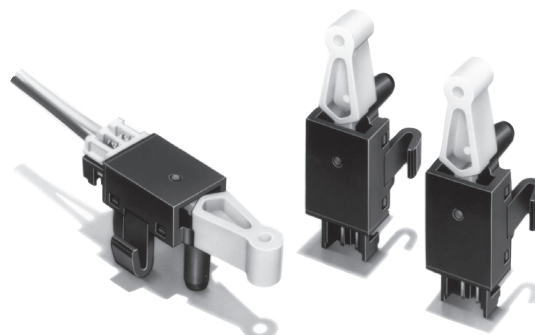

Ordering Information

Actuator	Terminal	Contact OF	Model
			Standard Model
Center mounted rotary lever	Crimp-type connector	50 g	D2X-C

Specifications

■ Characteristics

Electrical ratings	0.1 A, 30 VDC (resistive load)
Operating speed	0.1 mm to 100 mm/second
Operating frequency	Mechanical: 60 operations per minute Electrical: 30 operations per minute
Contact resistance	200 mΩ max.
Insulation resistance	100 MΩ min. at 250 VDC
Dielectric strength	250 VAC, 50/60 Hz for 1 minute between terminals of same polarity 250 VAC, 50/60 Hz for 1 minute between current-carrying metal parts and ground
Vibration resistance	Malfunction: 10 to 55 Hz, 1.5 mm double amplitude
Shock resistance	Destruction: 500 m/s ² (approx. 50G) max. Malfunction: 300 m/s ² (approx. 30G) max.
Degree of protection	IEC IP00
Degree of protection against electric shock	Class I
Proof tracking index (PTI)	175
Ambient operating temperature	-10° to 70°C (at 60% RH max.) with no icing
Ambient operating humidity	45% to 85% (for 5°C to 35°C)
Service life	Mechanical: 1,000,000 operations min. Electrical: 50,000 operations min.
Weight	Approx. 1 g

Note: 1. Data shown are of initial value.

2. The ratings apply under the following test conditions: Ambient Temperature = 20±2°C, Ambient Humidity = 65±5%, Operating frequency = 30 operations/min.

Engineering Data

Contact Specifications

Item	Specification
Specification	Slide
Material	Gold plated
Minimum applicable load (see note)	1 mA at 5 VDC

Note: Minimum applicable loads are indicated by N standard reference values. This value represents the failure rate at a 60% (λ_{60}) reliability level (JIS C5003).

The equation $\lambda_{60}=0.5 \times 10^{-6}/\text{operations}$ indicates that a failure rate of 1/2,000,000 operations can be expected at a reliability level of 60%.

Contact Form

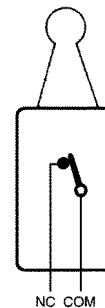

Panel Mounting Holes

- Note:** 1. Unless otherwise specified, all units are in millimeters and a tolerance of ± 0.1 mm applies to all dimensions
- 2. The tolerance from the center of each hole is ± 0.07
- 3. Make sure that any burrs are located on the backside of the mounting plate

With 1.6 mm panel thickness

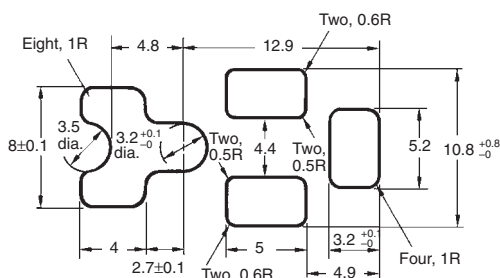

With 1.2 mm panel thickness

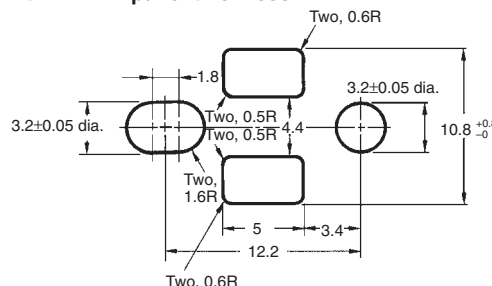

Dimensions

- Note:** 1. Unless otherwise specified, all units are in millimeters and a tolerance of ± 0.4 mm applies to all dimensions.
- 2. The operating characteristics are for cases where the actuator operates in the A (\leftarrow) direction or B (\rightarrow) direction.

D2X-C

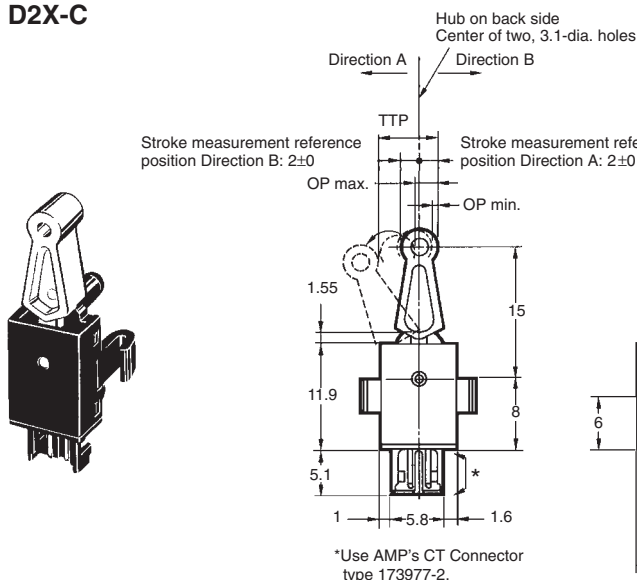

OF	50 g
RF min.	2 g
OP	2° to 9° max. or 0.52 to 2.35 mm
TTP max.	25° or 6.34 mm

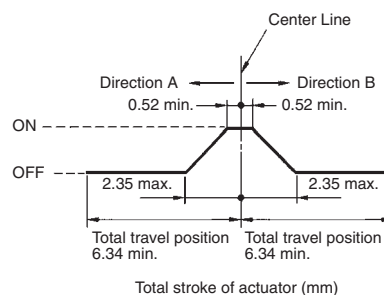

Precautions

Be sure to read the precautions and information common to all Snap Action and Detection Switches, contained in the Technical User's Guide, "Snap Action Switches, Technical Information" for correct use.

■ Correct Use

Operating Object

For proper operation, follow these guidelines:

Set the dog or cam stroke so the actuator does not receive excessive force when the switch is actuated. When the actuator is released, the dog or cam must not be touching the actuator head.

Set the dog or cam so that it will press the head of the lever in the traveling direction of the lever.

Do not allow the lever to be pressed beyond the TTP, otherwise the D2X may be damaged.

Lever Load

Do not impose loads in the following directions on the lever, otherwise the Switch may be damaged or malfunction.

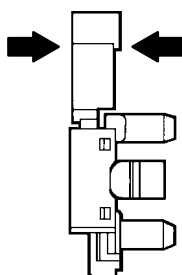

Microload

Be sure that the load is within the following range:

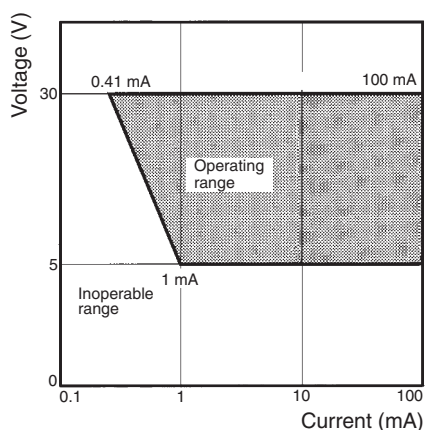

■ Wiring Connector

Use the following type CT connectors of AMP for wiring.

Press-fit connector: 173997-2

Crimp-style connector housing: 179228-2

Crimp-style connector contact: 179227-1

The above connectors are not sold by Omron.

Contact Tyco Electronic's AMP offices for these connectors

All sales are subject to Omron Electronic Components LLC standard terms and conditions of sale, which can be found at http://www.components.omron.com/components/web/webfiles.nsf/sales_terms.html

ALL DIMENSIONS SHOWN ARE IN MILLIMETERS.
To convert millimeters into inches, multiply by 0.03937. To convert grams into ounces, multiply by 0.03527.

OMRON[®]

**OMRON ELECTRONIC
COMPONENTS LLC**

55 E. Commerce Drive, Suite B
Schaumburg, IL 60173

847-882-2288

OMRON ON-LINE

Global - <http://www.omron.com>

USA - <http://www.components.omron.com>

Cat. No. X303-E-1

11/10

Specifications subject to change without notice

Printed in USA