

DC Power Relays (200-A Models) G9EC-1

DC Power Relays Capable of Interrupting High-voltage, High-current Loads

- A compact relay capable of switching 400-V 200-A DC loads. (Capable of interrupting 1,000 A at 400 VDC max.)
- The switching section and driving section are gas-injected and hermetically sealed, allowing these compact relays to interrupt high-capacity loads. The sealed construction also requires no arc space, saves space, and helps ensure safe applications.
- Downsizing and optimum design allow no restrictions on the mounting direction.
- Terminal Cover is also available for industrial applications.
- UL/CSA standard UL508 approved.



Model Number Structure

Model Number Legend

G9EC-□-□-□-□
1 2 3 4

1. Number of Poles

1: 1 pole

2. Contact Form

Blank: SPST-NO

3. Coil Terminals

B: M3.5 screw terminals (standard)

Blank: Lead wire output

4. Special Functions

Ordering Information

List of Models

Models	Terminals		Contact form	Coil rated voltage	Model
	Coil terminals	Contact terminals			
Switching/current conduction models	Screw terminals	Screw terminals	SPST-NO	12 VDC 24 VDC 48 VDC 60 VDC 100 VDC	G9EC-1-B
	Lead wire				G9EC-1

- Note:**
1. Relays come with two M8 nuts for the main terminals (contacts).
 2. Relays with coil terminals and screw terminals come with two M3.5 screws.

Specifications

■ Ratings

Coil

Rated voltage	Rated current	Coil resistance	Must-operate voltage	Must-release voltage	Maximum voltage (See note 3.)	Power consumption
12 VDC	938 mA	12.8 Ω	75% max. of rated voltage	8% min. of rated voltage	110% of rated voltage	Approx. 11 W
24 VDC	469 mA	51.2 Ω				
48 VDC	234 mA	204.8 Ω				
60 VDC	188 mA	320.0 Ω				
100 VDC	113 mA	888.9 Ω				

- Note:**
- The figures for the rated current and coil resistance are for a coil temperature of 23°C and have a tolerance of ±10%.
 - The figures for the operating characteristics are for a coil temperature of 23°C.
 - The figure for the maximum voltage is the maximum voltage that can be applied to the relay coil for period of 10 minutes at an ambient temperature of 23°C. It does not apply to continuous operation.

Contacts

Item	Resistive load
	G9EC-1(-B)
Rated load	200 A at 400 VDC
Rated carry current	200 A
Maximum switching voltage	400 V
Maximum switching current	200 A

■ Characteristics

Item	G9EC-1(-B)	
Contact resistance (See note 2.)	30 mΩ max. (0.2 mΩ typical)	
Contact voltage drop	0.1 V max. (for a carry current of 200 A)	
Operate time	50 ms max.	
Release time	30 ms max.	
Insulation resistance (See note 3.)	Between coil and contacts	1,000 MΩ min.
	Between contacts of the same polarity	1,000 MΩ min.
Dielectric strength	Between coil and contacts	2,500 VAC, 1 min
	Between contacts of the same polarity	2,500 VAC, 1 min
Impulse withstand voltage (See note 4.)	4,500 V	
Vibration resistance	Destruction	10 to 55 to 10 Hz 0.75-mm single amplitude (Acceleration: 2.94 to 88.9 m/s ²)
	Malfunction	10 to 55 to 10 Hz 0.75-mm single amplitude (Acceleration: 2.94 to 88.9 m/s ²)
Shock resistance	Destruction	490 m/s ²
	Malfunction	196 m/s ²
Mechanical endurance (See note 5.)	200,000 operations min.	
Electrical endurance (resistive load) (See note 6.)	400 VDC, 200 A, 3,000 operations min.	
Short-time carry current	300 A (15 min)	
Maximum interruption current	1,000 A at 400 VDC (10 times)	
Overload interruption	700 A at 400 VDC (40 times min.)	
Reverse polarity interruption	-200 A at 200 VDC (1,000 times min.)	
Ambient operating temperature	-40 to 50°C (with no icing or condensation)	
Ambient operating humidity	5% to 85%	
Weight	Approx. 560 g	

- Note:**
- The above values are initial values at an ambient temperature of 23°C unless otherwise specified.
 - The contact resistance was measured with 1 A at 5 VDC using the voltage drop method.
 - The insulation resistance was measured with a 500-VDC megohmmeter.
 - The impulse withstand voltage was measured with a JEC-212 (1981) standard impulse voltage waveform (1.2 × 50 μs).
 - The mechanical endurance was measured at a switching frequency of 3,600 operations/hr.
 - The electrical endurance was measured at a switching frequency of 60 operations/hr.

Engineering Data

■ G9EC-1(-B) Switching/Current Conduction Models

Maximum Switching Capacity

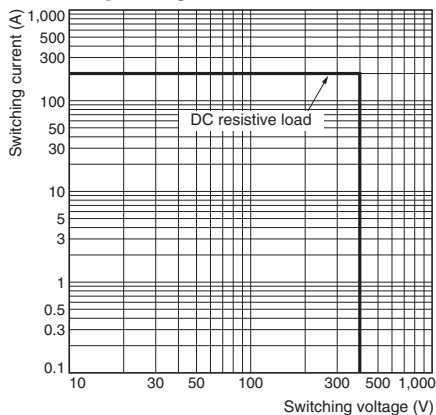

Electrical Endurance (Switching Performance)

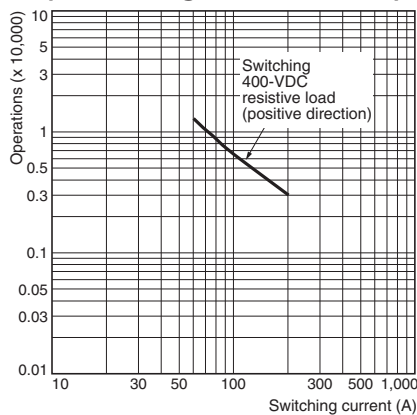

Electrical Endurance (Interruption Performance)

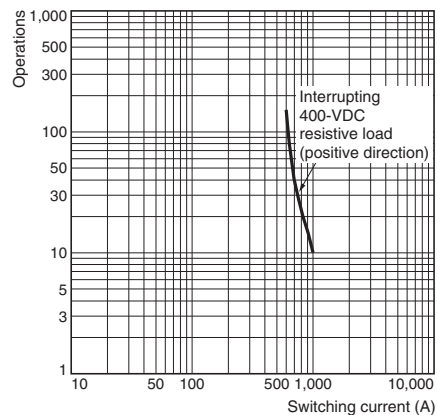

Carry Current vs Energizing Time

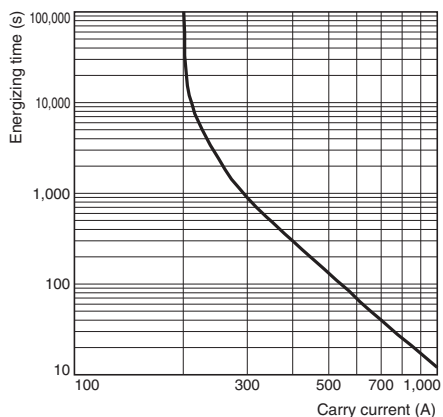

Must-operate Voltage and Must-release Voltage Distributions

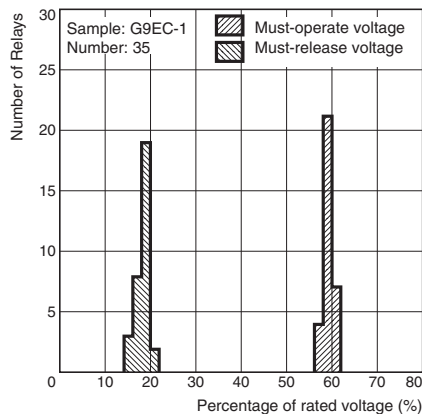

Time Characteristic Distributions

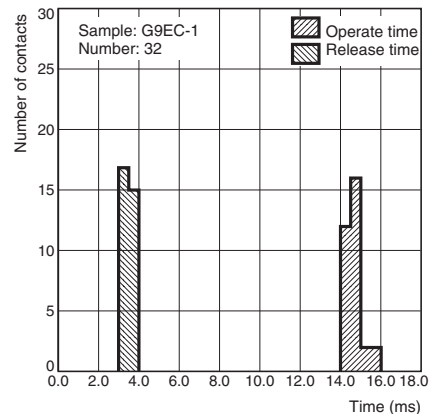

Vibration Malfunction

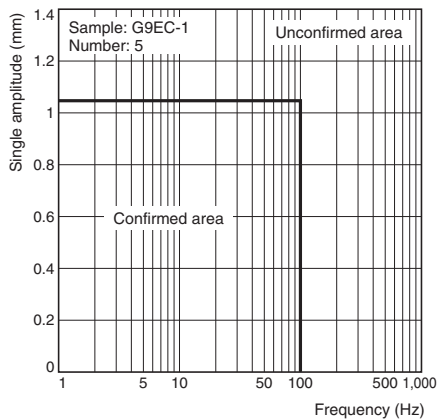

Vibration Resistance

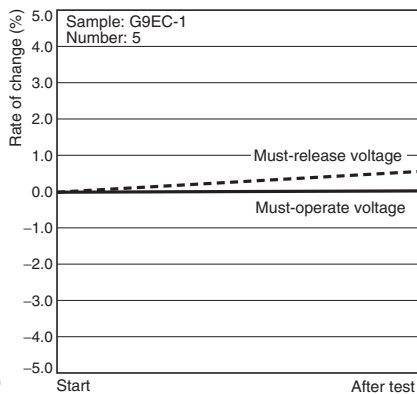

Characteristics were measured after applying vibration at a frequency of 10 to 55 Hz (single amplitude of 0.75 mm) to the test piece (not energized) for 2 hours each in 3 directions. The percentage rate of change is the average value for all of the samples

Shock Malfunction

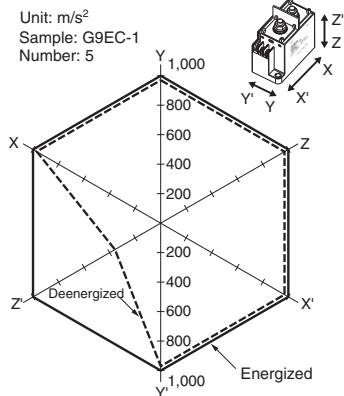

The value at which malfunction occurred was measured after applying shock to the test piece 3 times each in 6 directions along 3 axes.

Shock Resistance

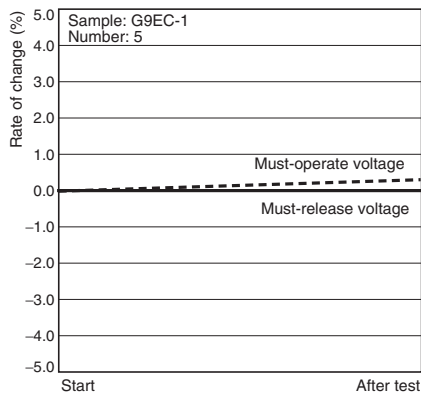

Characteristics were measured after applying a shock of $490 m/s^2$ to the test piece 3 times each in 6 directions along 3 axes. The percentage rate of change is the average value for all of the samples.

Dimensions

Note: All units are in millimeters unless otherwise indicated.

Models with Screw Terminals

G9EC-1-B

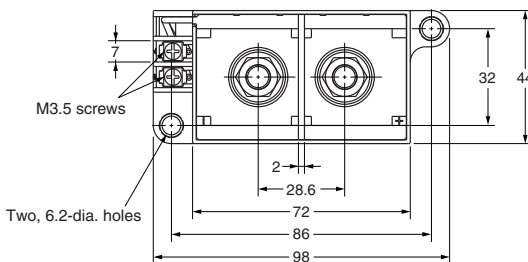
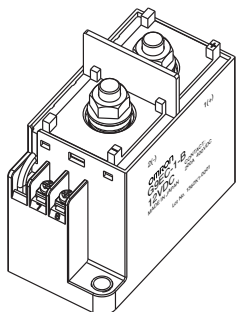

Terminal Arrangement/
Internal Connections
(TOP VIEW)

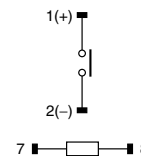

Note: Be sure to connect terminals with the correct polarity. Coils do not have polarity.

Mounting Hole Dimensions
(TOP VIEW)

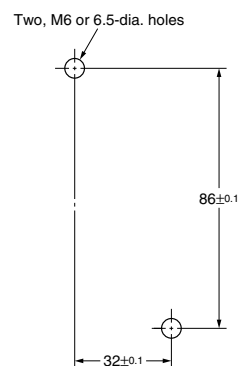

Dimension (mm)	Tolerance (mm)
10 or lower	±0.3
10 to 50	±0.5
50 or higher	±1

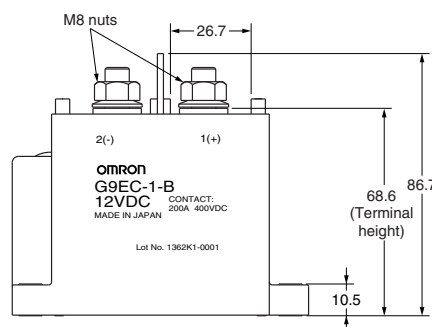
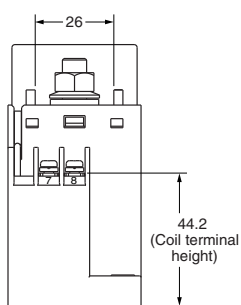

Models with Lead Wires

G9EC-1

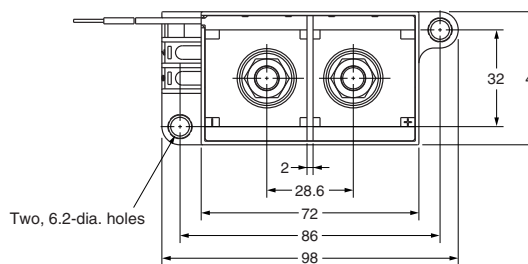
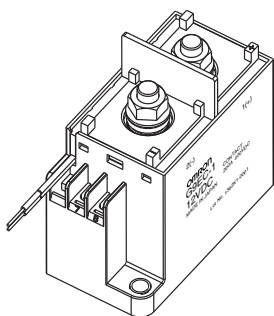

Terminal Arrangement/
Internal Connections
(TOP VIEW)

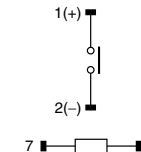

Note: Be sure to connect terminals with the correct polarity. Coils do not have polarity.

Mounting Hole Dimensions
(TOP VIEW)

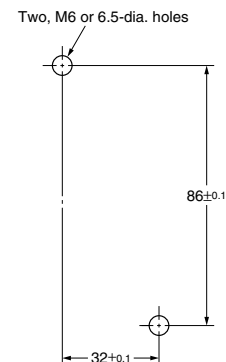

Dimension (mm)	Tolerance (mm)
10 or lower	±0.3
10 to 50	±0.5
50 or higher	±1

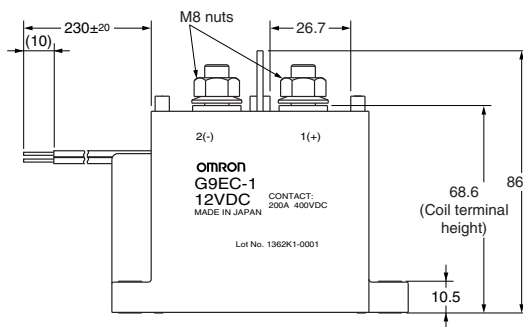
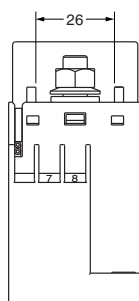

■ Options

Terminal Cover

P9EC-C

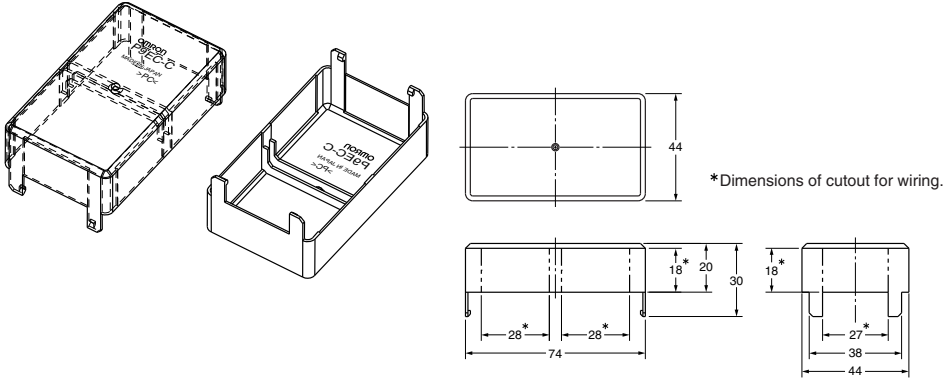

Note: Be sure to remove the cutouts for wiring that are located in the wiring outlet direction before installing the Terminal Cover.

Dimension (mm)	Tolerance (mm)
10 or lower	±0.3
10 to 50	±0.5
50 or higher	±1

Precautions

⚠ WARNING
 Take measures to prevent contact with charged parts when using the Relay for high voltages.

■ Correct Use

Refer to the relevant catalog for common precautions.

1. Be sure to tighten all screws to the appropriate torque given below. Loose screws may result in burning due to abnormal heat generation during energization.
 - M8 screws: 8.82 to 9.80 N·m
 - M6 screws: 3.92 to 4.90 N·m
 - M5 screws: 1.57 to 2.35 N·m
 - M4 screws: 0.98 to 1.37 N·m
 - M3.5 screws: 0.75 to 1.18 N·m
2. The G9EA and G9EC Relays' contacts have polarity. Be sure to perform connections with the correct polarity. If the contacts are connected with the reverse polarity, the switching characteristics specified in this document cannot be assured.
3. Do not drop or disassemble this Relay. Not only may the Relay fail to meet the performance specifications, it may also result in damage, electric shock, or burning.
4. Do not use these Relays in strong magnetic fields of 800 A/m or higher (e.g., near transformers or magnets). The arc discharge that occurs during switching may be bent by the magnetic field, resulting in flashover or insulation faults.
5. This Relay is a device for switching high DC voltages. If it is used for voltages exceeding the specified range, it may not be possible to interrupt the load and burning may result. In order to prevent fire spreading, use a configuration in which the current load can be interrupted in the event of emergencies.
 In order to ensure safety of the system, replace the Relay on a regular basis.
6. If the Relay is used for no-load switching, the contact resistance may increase and so confirm correct operation under the actual operating conditions.
7. These Relays contain pressurized gas. Even in applications with low switching frequencies, the ambient temperature and heat caused by arc discharge in the contacts may allow permeation of the sealed gas, resulting in arc interruption failure.
 In order to ensure safety of the system, replace Relays on a regular basis.
8. Do not use or store the Relay in a vacuum. Doing so will accelerate deterioration of the sealing.
9. With this Relay, if the rated voltage (or current) is continuously applied to the coil and contacts, and then turned OFF and immediately ON again, the coil temperature, and consequently the coil resistance, will be higher than usual. This means that the must-operate voltage will also be higher than usual, exceeding the rated value ("hot start"). In this case, take the appropriate countermeasures, such as reducing the load current or restricting the energizing time or ambient operating temperature.
10. The ripple percentage for DC relays can cause fluctuations in the must-operate voltage or humming. For this reason, reduce the ripple percentage in full-wave rectified power supply circuits by adding a smoothing capacitor. Ensure that the ripple percentage is less than 5%.
11. Ensure that a voltage exceeding the specified maximum voltage is not continuously applied to the coil. Abnormal heating in the coil may shorten the lifetime of the insulation coating.
12. Do not use the Relay at a switching voltage or current greater than the specified maximum values. Doing so may result in arc discharge interruption failure or burning due to abnormal heating in the contacts.

13. The contact ratings are for resistive loads. The electrical endurance with inductive loads is inferior to that of resistive loads. Confirm correct operation under the actual operating conditions.
14. Do not use the Relay in locations where water, solvents, chemicals, or oil may come in contact with the case or terminals. Doing so may result in deterioration of the case resin or abnormal heating due to corrosion or contamination of the terminals. Also, if electrolyte adheres to the output terminals, electrolysis may occur between the output terminals, resulting in corrosion of the terminals or wiring disconnections.
15. Be sure to turn OFF the power and confirm that there is no residual voltage before replacing the Relay or performing wiring.
16. The distance between crimp terminals or other conductive parts will be reduced and insulation properties will be lowered if wires are laid in the same direction from the contact terminals. Use insulating coverings, do not wire in the same direction, and take other measures as required to maintain insulation properties.
17. Use either a varistor, or a diode plus Zener diode as a protective circuit against reverse surge in the relay coil. Using a diode alone will reduce the switching characteristics.
18. Do not tighten the screws to a torque exceeding 11 N·m for the M8 screws and 5 N·m for the M5 screws.
 Overtightening the contact terminals will reduce the switching performance and damage the product.
19. Be sure to use the screws provided with the product for wiring coil terminals and contact terminals. The specified tightening torque cannot be achieved with different screws and may result in abnormal heat generation when energized.

The coil's power consumption can be reduced by using in combination with a semiconductor circuit. Consult your OMRON representative for details.

Recommended Wire Size

Model	Size
G9EC-1(-B)	38 to 60 mm ²

Note: Use flexible leads.

MEMO

A large grid of dashed lines for taking notes, consisting of 20 columns and 30 rows of small squares.

Omron Electronic Components, LLC

Terms and Conditions of Sales

I. GENERAL

- Definitions:** The words used herein are defined as follows.
 - Terms:** These terms and conditions
 - Seller:** Omron Electronic Components LLC and its subsidiaries
 - Buyer:** The buyer of Products, including any end user in section III through VI
 - Products:** Products and/or services of Seller
 - Including:** Including without limitation
- Offer; Acceptance:** These Terms are deemed part of all quotations, acknowledgments, invoices, purchase orders and other documents, whether electronic or in writing, relating to the sale of Products by Seller. Seller hereby objects to any Terms proposed in Buyer's purchase order or other documents which are inconsistent with, or in addition to, these Terms.
- Distributor:** Any distributor shall inform its customer of the contents after and including section III of these Terms.

II. SALES

- Prices; Payment:** All prices stated are current, subject to change without notice by Seller. Buyer agrees to pay the price in effect at the time the purchase order is accepted by Seller. Payments for Products received are due net 30 days unless otherwise stated in the invoice. Buyer shall have no right to set off any amounts against the amount owing in respect of this invoice.
- Discounts:** Cash discounts, if any, will apply only on the net amount of invoices sent to Buyer after deducting transportation charges, taxes and duties, and will be allowed only if (a) the invoice is paid according to Seller's payment terms and (b) Buyer has no past due amounts owing to Seller.
- Interest:** Seller, at its option, may charge Buyer 1.5% interest per month or the maximum legal rate, whichever is less, on any balance not paid within the stated terms.
- Orders:** Seller will accept no order less than 200 U.S. dollars net billing.
- Currencies:** If the prices quoted herein are in a currency other than U.S. dollars, Buyer shall make remittance to Seller at the then current exchange rate most favorable to Seller; provided that if remittance is not made when due, Buyer will convert the amount to U.S. dollars at the then current exchange rate most favorable to Seller available during the period between the due date and the date remittance is actually made.
- Governmental Approvals:** Buyer shall be responsible for all costs involved in obtaining any government approvals regarding the importation or sale of the Products.
- Taxes:** All taxes, duties and other governmental charges (other than general real property and income taxes), including any interest or penalties thereon, imposed directly or indirectly on Seller or required to be collected directly or indirectly by Seller for the manufacture, production, sale, delivery, importation, consumption or use of the Products sold hereunder (including customs duties and sales, excise, use, turnover and license taxes) shall be charged to and remitted by Buyer to Seller.
- Financial:** If the financial position of Buyer at any time becomes unsatisfactory to Seller, Seller reserves the right to stop shipments or require satisfactory security or payment in advance. If Buyer fails to make payment or otherwise comply with these Terms or any related agreement, Seller may (without liability and in addition to other remedies) cancel any unshipped portion of Products sold hereunder and stop any Products in transit until Buyer pays all amounts, including amounts payable hereunder, whether or not then due, which are owing to it by Buyer. Buyer shall in any event remain liable for all unpaid accounts.
- Cancellation; Etc:** Orders are not subject to rescheduling or cancellation unless Buyer indemnifies Seller fully against all costs or expenses arising in connection therewith.
- Force Majeure:** Seller shall not be liable for any delay or failure in delivery resulting from causes beyond its control, including earthquakes, fires, floods, strikes or other labor disputes, shortage of labor or materials, accidents to machinery, acts of sabotage, riots, delay in or lack of transportation or the requirements of any government authority.
- Shipping; Delivery:** Unless otherwise expressly agreed in writing by Seller:
 - All sales and shipments of Products shall be FOB shipping point (unless otherwise stated in writing by Seller), at which point title to and all risk of loss of the Products shall pass from Seller to Buyer, provided that Seller shall retain a security interest in the Products until the full purchase price is paid by Buyer;
 - Delivery and shipping dates are estimates only; and
 - Seller will package Products as it deems proper for protection against normal handling and extra charges apply to special conditions.
- Claims:** Any claim by Buyer against Seller for shortage or damage to the Products occurring before delivery to the carrier or any claim related to pricing or other charges must be presented in detail in writing to Seller within 30 days of receipt of shipment.

III. PRECAUTIONS

- Suitability:** IT IS THE BUYER'S SOLE RESPONSIBILITY TO ENSURE THAT ANY OMRON PRODUCT IS FIT AND SUFFICIENT FOR USE IN A MOTORIZED VEHICLE APPLICATION. BUYER SHALL BE SOLELY RESPONSIBLE FOR DETERMINING APPROPRIATENESS OF THE PARTICULAR PRODUCT WITH RESPECT TO THE BUYER'S APPLICATION INCLUDING (A) ELECTRICAL OR ELECTRONIC COMPONENTS, (B) CIRCUITS, (C) SYSTEM ASSEMBLIES, (D) END PRODUCT, (E) SYSTEM, (F) MATERIALS OR SUBSTANCES OR (G) OPERATING ENVIRONMENT. Buyer acknowledges that it alone has determined that the Products will meet their requirements of the intended use in all cases. Buyer must know and observe all prohibitions of use applicable to the Product/s.
- Use with Attention:** The followings are some examples of applications for which particular attention must be given. This is not intended to be an exhaustive list of all possible use of any Product, nor to imply that any use listed may be suitable for any Product:
 - Outdoor use, use involving potential chemical contamination or electrical interference.

- Use in consumer Products or any use in significant quantities.
 - Energy control systems, combustion systems, railroad systems, aviation systems, medical equipment, amusement machines, vehicles, safety equipment, and installations subject to separate industry or government regulations.
 - Systems, machines, and equipment that could present a risk to life or property.
- Prohibited Use:** NEVER USE THE PRODUCT FOR AN APPLICATION INVOLVING SERIOUS RISK TO LIFE OR PROPERTY WITHOUT ENSURING THAT THE SYSTEM AS A WHOLE HAS BEEN DESIGNED TO ADDRESS THE RISKS, AND THAT THE PRODUCT IS PROPERLY RATED AND INSTALLED FOR THE INTENDED USE WITHIN THE OVERALL EQUIPMENT OR SYSTEM.
 - Motorized Vehicle Application:** USE OF ANY PRODUCT/S FOR A MOTORIZED VEHICLE APPLICATION MUST BE EXPRESSLY STATED IN THE SPECIFICATION BY SELLER.
 - Programmable Products:** Seller shall not be responsible for the Buyer's programming of a programmable Product.

IV. WARRANTY AND LIMITATION

- Warranty:** Seller's exclusive warranty is that the Products will be free from defects in materials and workmanship for a period of twelve months from the date of sale by Seller (or such other period expressed in writing by Seller). SELLER MAKES NO WARRANTY OR REPRESENTATION, EXPRESS OR IMPLIED, ABOUT ALL OTHER WARRANTIES, NON-INFRINGEMENT, MERCHANTABILITY OR FITNESS FOR A PARTICULAR PURPOSE OF THE PRODUCTS.
- Buyer Remedy:** Seller's sole obligation hereunder shall be to replace (in the form originally shipped with Buyer responsible for labor charges for removal or replacement thereof) the non-complying Product or, at Seller's election, to repay or credit Buyer an amount equal to the purchase price of the Product; provided that there shall be no liability for Seller or its affiliates unless Seller's analysis confirms that the Products were correctly handled, stored, installed and maintained and not subject to contamination, abuse, misuse or inappropriate modification. Return of any Products by Buyer must be approved in writing by Seller before shipment.
- Limitation on Liability:** SELLER AND ITS AFFILIATES SHALL NOT BE LIABLE FOR SPECIAL, INDIRECT, INCIDENTAL OR CONSEQUENTIAL DAMAGES, LOSS OF PROFITS OR PRODUCTION OR COMMERCIAL LOSS IN ANY WAY CONNECTED WITH THE PRODUCTS, WHETHER SUCH CLAIM IS BASED IN CONTRACT, WARRANTY, NEGLIGENCE OR STRICT LIABILITY. FURTHER, IN NO EVENT SHALL LIABILITY OF SELLER OR ITS AFFILIATES EXCEED THE INDIVIDUAL PRICE OF THE PRODUCT ON WHICH LIABILITY IS ASSERTED.
- Indemnities:** Buyer shall indemnify and hold harmless Seller, its affiliates and its employees from and against all liabilities, losses, claims, costs and expenses (including attorney's fees and expenses) related to any claim, investigation, litigation or proceeding (whether or not Seller is a party) which arises or is alleged to arise from Buyer's acts or omissions under these Terms or in any way with respect to the Products.

V. INFORMATION; ETC.

- Intellectual Property:** The intellectual property embodied in the Products is the exclusive property of Seller and its affiliates and Buyer shall not attempt to duplicate it in any way without the written permission of Seller. Buyer (at its own expense) shall indemnify and hold harmless Seller and defend or settle any action brought against Seller to the extent that it is based on a claim that any Product made to Buyer specifications infringed intellectual property rights of another party.
- Property; Confidentiality:** Notwithstanding any charges to Buyer for engineering or tooling, all engineering and tooling shall remain the exclusive property of Seller. All information and materials supplied by Seller to Buyer relating to the Products are confidential and proprietary, and Buyer shall limit distribution thereof to its trusted employees and strictly prevent disclosure to any third party.
- Performance Data:** Performance data is provided as a guide in determining suitability and does not constitute a warranty. It may represent the result of Seller's test conditions, and the users must correlate it to actual application requirements.
- Change In Specifications:** Product specifications and descriptions may be changed at any time based on improvements or other reasons. It is Seller's practice to change part numbers when published ratings or features are changed, or when significant engineering changes are made. However, some specifications of the Product may be changed without any notice.
- Errors And Omissions:** The information on Seller's website or in other documentation has been carefully checked and is believed to be accurate; however, no responsibility is assumed for clerical, typographical or proofreading errors or omissions.
- Export Controls:** Buyer shall comply with all applicable laws, regulations and licenses regarding (a) export of the Products or information provided by Seller; (b) sale of Products to forbidden or other proscribed persons or organizations; (c) disclosure to non-citizens of regulated technology or information.

VI. MISCELLANEOUS

- Waiver:** No failure or delay by Seller in exercising any right and no course of dealing between Buyer and Seller shall operate as a waiver of rights by Seller.
- Assignment:** Buyer may not assign its rights hereunder without Seller's written consent.
- Law:** These Terms are governed by Illinois law (without regard to conflict of laws). Federal and state courts in Cook County, Illinois have exclusive jurisdiction for any dispute hereunder.
- Amendment:** These Terms constitute the entire agreement between Buyer and Seller relating to the Products, and no provision may be changed or waived unless in writing signed by the parties.
- Severability:** If any provision hereof is rendered ineffective or invalid, such provision shall not invalidate any other provision.

Certain Precautions on Specifications and Use

1. **Suitability for Use.** Seller shall not be responsible for conformity with any standards, codes or regulations which apply to the combination of the Product in Buyer's application or use of the Product. At Buyer's request, Seller will provide applicable third party certification documents identifying ratings and limitations of use which apply to the Product. This information by itself is not sufficient for a complete determination of the suitability of the Product in combination with the end product, machine, system, or other application or use. Buyer shall be solely responsible for determining appropriateness of the particular Product with respect to Buyer's application, product or system. Buyer shall take application responsibility in all cases but the following is a non-exhaustive list of applications for which particular attention must be given:
 - (i) Outdoor use, uses involving potential chemical contamination or electrical interference, or conditions or uses not described in this document.
 - (ii) Energy control systems, combustion systems, railroad systems, aviation systems, medical equipment, amusement machines, vehicles, safety equipment, and installations subject to separate industry or government regulations.
 - (iii) Use in consumer products or any use in significant quantities.
 - (iv) Systems, machines and equipment that could present a risk to life or property. Please know and observe all prohibitions of use applicable to this product.

NEVER USE THE PRODUCT FOR AN APPLICATION INVOLVING SERIOUS RISK TO LIFE OR PROPERTY WITHOUT ENSURING THAT THE SYSTEM AS A WHOLE HAS BEEN DESIGNED TO ADDRESS THE RISKS, AND THAT THE OMRON PRODUCT IS PROPERLY RATED AND INSTALLED FOR THE INTENDED USE WITHIN THE OVERALL EQUIPMENT OR SYSTEM.
2. **Programmable Products.** Seller shall not be responsible for the user's programming of a programmable product, or any consequence thereof.
3. **Performance Data.** Performance data given in this publication is provided as a guide for the user in determining suitability and does not constitute a warranty. It may represent the result of Seller's test conditions, and the users must correlate it to actual application requirements. Actual performance is subject to Seller's Warranty and Limitations of Liability.
4. **Change in Specifications.** Product specifications and accessories may be changed at any time based on improvements and other reasons. It is our practice to change part numbers when published ratings or features are changed, or when significant construction changes are made. However, some specifications of the Product may be changed without any notice. When in doubt, special part numbers may be assigned to fix or establish key specifications for your application. Please consult with your Seller representative at any time to confirm actual specifications of purchased Product.
5. **Errors and Omissions.** The information in this publication has been carefully checked and is believed to be accurate; however, no responsibility is assumed for clerical, typographical or proofreading errors, or omissions.
6. **RoHS Compliance.** Where indicated, our products currently comply, to the best of our knowledge as of the date of this publication, with the requirements of the European Union's Directive on the Restriction of certain Hazardous Substances ("RoHS"), although the requirements of RoHS do not take effect until July 2006. These requirements may be subject to change. Please consult our website for current information.

Complete "Terms and Conditions of Sale" for product purchase and use are on Omron's website at <http://www.components.omron.com> – under the "About Us" tab, in the Legal Matters section.

ALL DIMENSIONS SHOWN ARE IN MILLIMETERS.

To convert millimeters into inches, multiply by 0.03937. To convert grams into ounces, multiply by 0.03527.

OMRON®

**OMRON ELECTRONIC
COMPONENTS LLC**

55 E. Commerce Drive, Suite B
Schaumburg, IL 60173

847-882-2288

OMRON ON-LINE

Global - <http://www.omron.com>

USA - <http://www.components.omron.com>

Cat. No. J144-E-05Aa

02/09

Specifications subject to change without notice

Printed in USA