

# Low Signal Relay G6L

## Extremely Thin SPST-NO Flat Relay, One of the Thinnest Relays in the World

- Uses 20% less mounting area and approximately 64% less volume in comparison with the G5V-1 relay.
- Measures just 7.0 (W) x 10.6 (L) x 4.5 (H) mm for surface-mount or 4.1 (H) for through-hole.
- High dielectric strength: 1,000 VAC between coil and contacts and 750 VAC between contacts of the same polarity.
- Conforms to FCC Part 68.
- UL recognized / CSA certified
- RoHS Compliant - Use of lead completely eliminated.

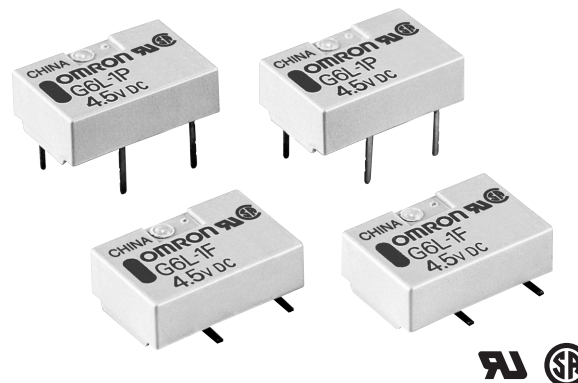

## Ordering Information

Contact form	Construction	Mounting type	Model
SPST-NO	Fully sealed	Through-hole terminal	G6L-1P
		Surface-mount terminal	G6L-1F

**Note:** 1. When ordering, add the rated coil voltage to the model number.

Example: G6L-1P DC12  
└─── Rated coil voltage

2. When ordering tape packing (surface mount versions), add "-TR" to the model number.

Example: G6L-1F-TR DC12  
└─── Tape packing

Be sure since "-TR" is not part of the relay model number, it is not marked on the relay case.

## Model Number Legend:

G6L - 1 □ - □ DC □  
1 2 3 4

**1. Contact Form**

1: SPST-NO

**2. Terminal Shape**

P: Through-hole  
 F: Surface mount

**3. Packaging**

None: Tube packaging  
 TR: Tape and reel packaging (SMT versions)

**4. Rated Coil Voltage**

3, 4.5, 5, 12, 24

## Application Examples

- Peripherals of MODEM/PC
- Telephones
- Office automation machines
- Audio-visual products
- Communications equipment
- Measurement devices
- Amusement equipment
- Security equipment

# Specifications

## ■ Contact Ratings

Item	Resistive load
Contact material	Ag (Au-alloy surface)
Contact type	Single crossbar
Rated load	0.3 A at 125 VAC, 1 A at 24 VDC
Carry current	1 A
Max. switching voltage	125 VAC, 60 VDC
Max. switching current	1 A
Min. permissible load - P level (See note)	1 mA at 5 VDC

**Note:** This value was measured at a switching frequency of 120 operations/min. This value may vary, depending on switching frequency, operating conditions, expected reliability level of the relay, etc. It is always recommended to double-check relay suitability under actual load conditions.

## ■ Coil Ratings

Item	Voltage Rating				
	3 VDC	4.5 VDC	5 VDC	12 VDC	24 VDC
Rated voltage	3 VDC	4.5 VDC	5 VDC	12 VDC	24 VDC
Rated current	60.0 mA	40.0 mA	36.0 mA	15.0 mA	9.6 mA
Coil resistance	50.0 Ω	112.5 Ω	139.0 Ω	800.0 Ω	2,504.0 Ω
Pick-up voltage	75% max. of rated voltage				
Dropout voltage	10% min. of rated voltage				
Maximum voltage	150% of rated voltage				130% of rated voltage
Power consumption	Approx. 180 mW				Approx. 230 mW

- Note:**
1. The rated current and coil resistance are measured at a coil temperature of 23°C with a tolerance of ±10%.
  2. The operating characteristics are measured at a coil temperature of 23°C.
  3. The maximum voltage is the highest voltage that can be imposed on the relay coil.
  4. The voltage measurements for Pick-up/Dropout are the values obtained for instantaneous changes in the voltage (rectangular wave).

## ■ Characteristics

Item	G6L-1P, G6L-1F	
Contact resistance (See Note 1)	100 mΩ max.	
Operate time (See Note 2)	5 ms max. (approx. 1.1 ms)	
Release time (See Note 2)	5 ms max. (approx. 0.4 ms)	
Insulation resistance (See Note 3)	1,000 MΩ min. (at 500 VDC)	
Dielectric strength	Coil and contacts	1,000 VAC, 50/60 Hz for 1 min
	Contacts of same poles	750 VAC, 50/60 Hz for 1 min
Surge withstand voltage	Coil and contacts	1,500 VAC, 10 × 160 μs
Vibration	Mechanical durability	10 to 55 Hz, 1.65-mm single amplitude (3.3-mm double amplitude)
	Malfunction durability	10 to 55 Hz, 1.65-mm single amplitude (3.3-mm double amplitude)
Shock	Mechanical durability	1,000 m/s <sup>2</sup>
	Malfunction durability	100 m/s <sup>2</sup>
Service life	Mechanical	5,000,000 operations min. (at 36,000 operations/hour)
	Electrical	100,000 operations min. (with a rated load at 1,800 operations/hour)
Ambient operating temperature	Operating: -40°C to 70°C (with no icing or condensation)	
Ambient operating humidity	Operating: 5% to 85% RH	
Weight	Approx. 0.6 g	

- Note:**
1. The contact resistance was measured with 10 mA at 1 VDC with a fall-of-potential method.
  2. Values in parentheses are actual values.
  3. The insulation resistance was measured with a 500-VDC megohmmeter applied to the same parts as those used for checking the dielectric strength.
  4. The above values are initial values.

# Engineering Data

## Maximum Switching Capacity

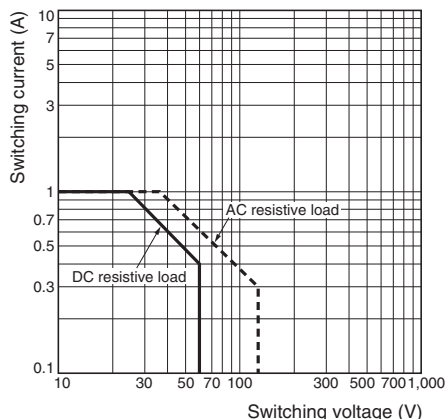

## Ambient Temperature vs. Maximum Voltage

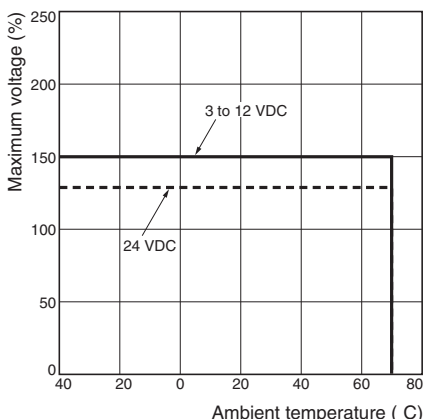

Note: "Maximum Voltage" is the maximum voltage that can be applied to the relay coil.

## Ambient Temperature vs. Switching Current

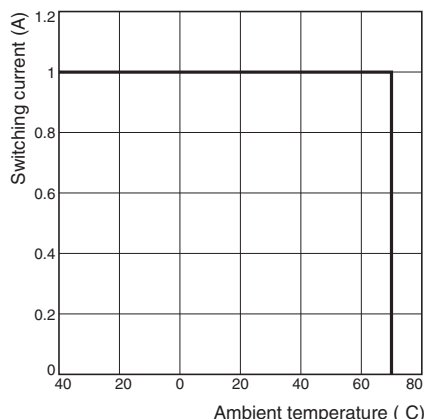

## Electrical Service Life

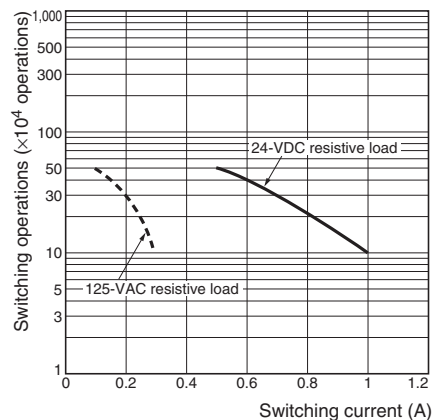

## Ambient Temperature vs. Must Operate or Must Release Voltage

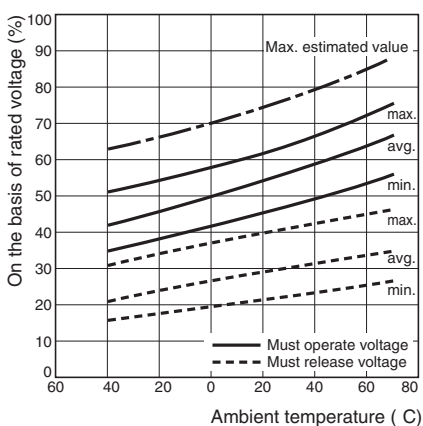

## Shock Malfunction

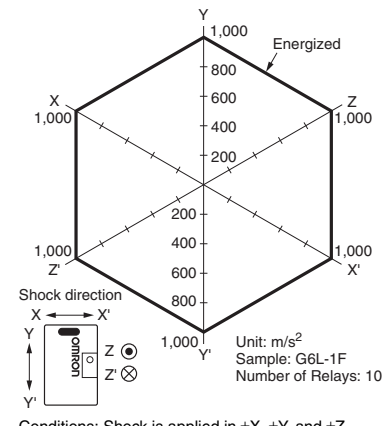

Conditions: Shock is applied in ±X, ±Y, and ±Z directions three times each with and without energizing the Relays to check the number of contact malfunctions.

## Electrical Service Life (with Must Operate and Must Release Voltage) (See note 1)

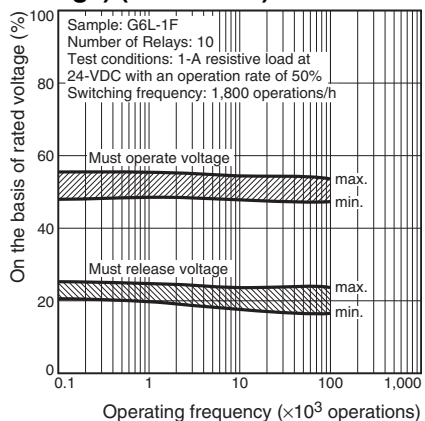

## Electrical Service Life (Contact Resistance) (See note 1)

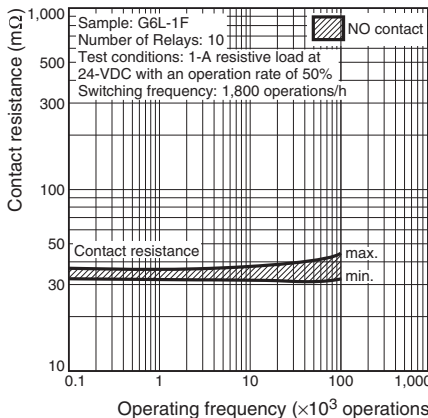

## Contact Reliability Test (Contact Resistance) (See notes 1 and 2)

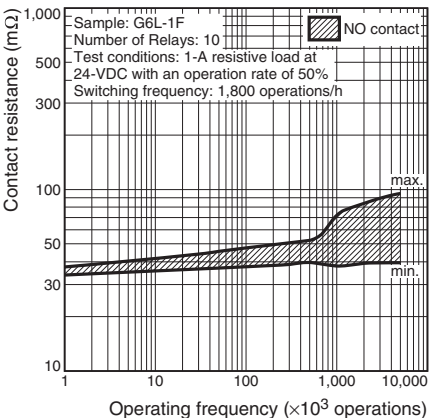

Note: 1. The tests were conducted at an ambient temperature of 23°C.  
2. The contact resistance data are periodically measured reference values and are not values from each monitoring operation. Contact resistance values will vary according to the switching frequency and operating environment, so be sure to check operation under the actual operating conditions before use.

### Mutual Magnetic Interference

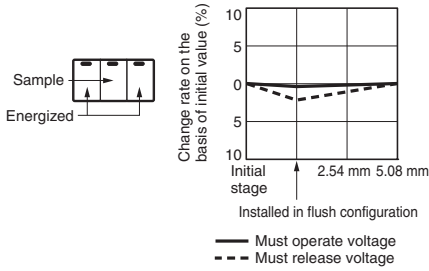

### Mutual Magnetic Interference

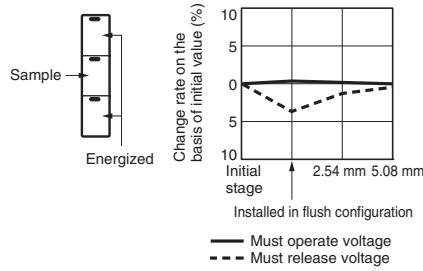

### External Magnetic Interference

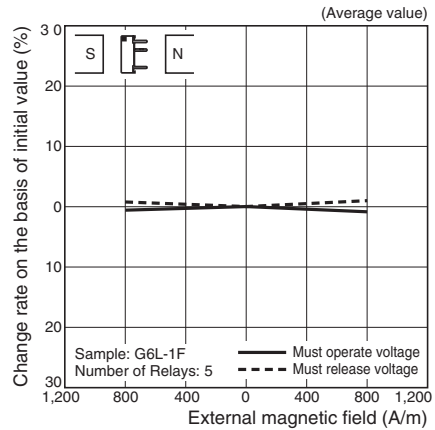
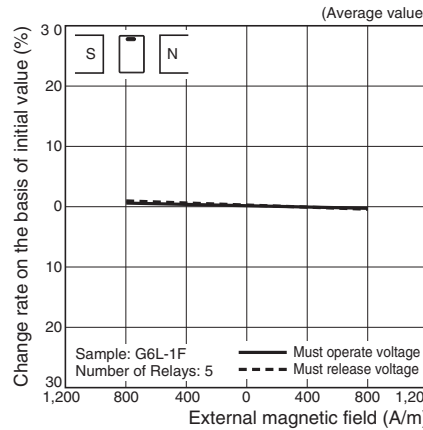
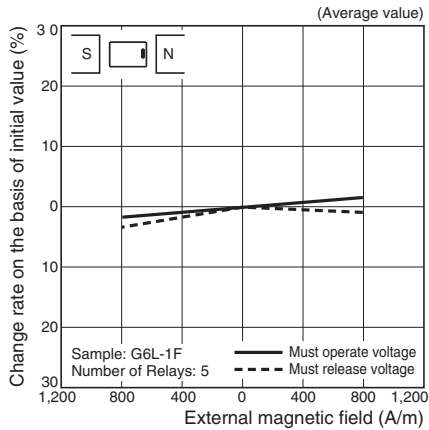

### High-frequency Characteristics (Isolation) (See notes)

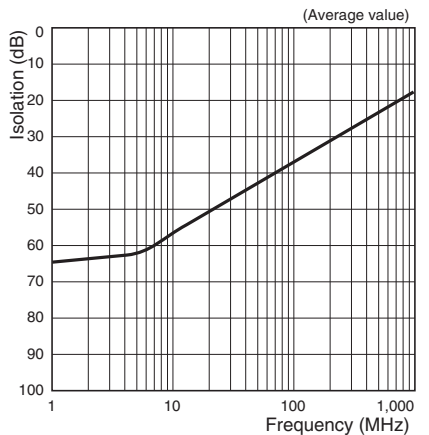

### High-frequency Characteristics (Insertion Loss) (See notes)

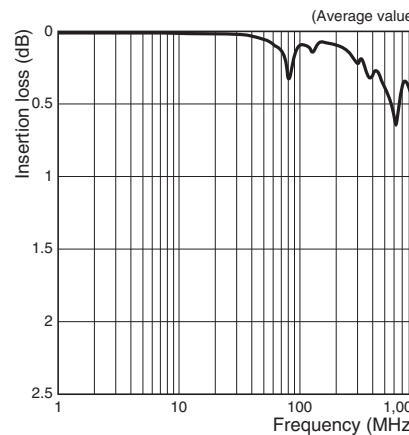

### High-frequency Characteristics (Return Loss, V.SWR) (See notes)

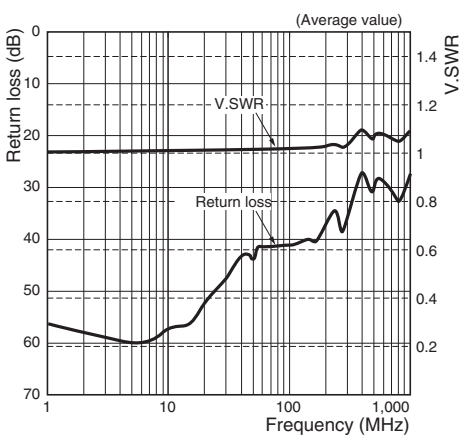

- Note:**
1. The tests were conducted at an ambient temperature of 23°C.
  2. High-frequency characteristics depend on the PCB to which the Relay is mounted. Always check these characteristics, including endurance, in the actual machine before use.

**Must Operate and Must Release Time Distribution (See Note)**

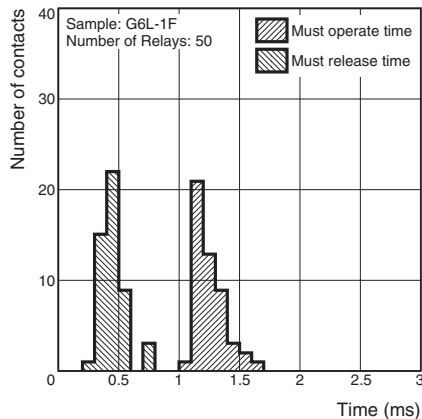

**Distribution of Bounce Time (See Note)**

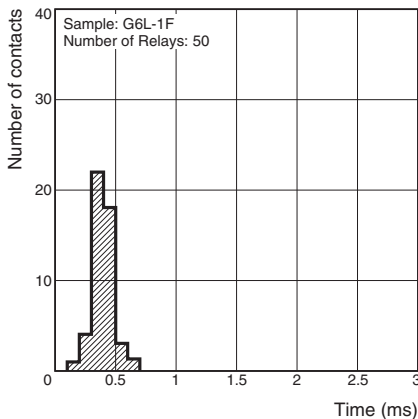

**Vibration Resistance**

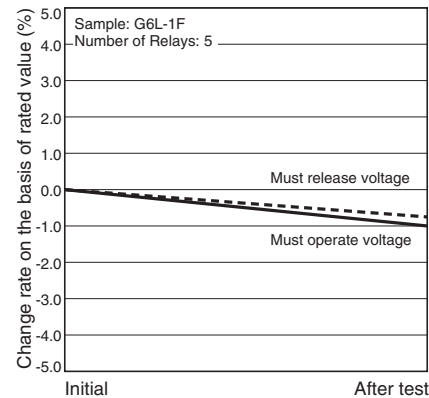

**Note:** The tests were conducted at an ambient temperature of 23°C.

**Dimensions**

**Note:** All units are in millimeters unless otherwise indicated.

**G6L-1P**

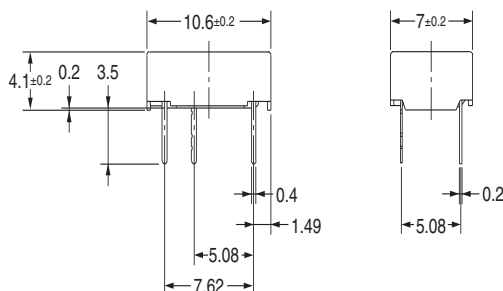
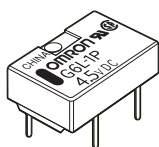

**Note:** Each value has a tolerance of  $\pm 0.3$  mm.

**PCB Mounting Holes (Bottom View)**  
Tolerance:  $\pm 0.1$  mm

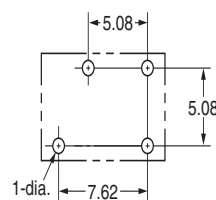

**Terminal Arrangement/ Internal Connections (Bottom View)**

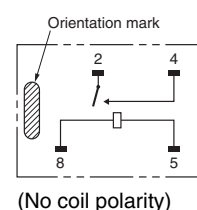

**G6L-1F**

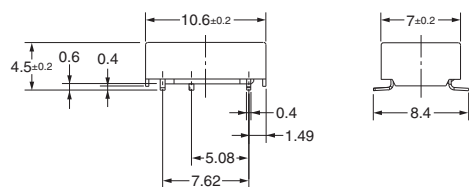
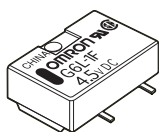

**Note:** Each value has a tolerance of  $\pm 0.3$  mm.  
The coplanarity of the terminals is 0.1 mm max.

**PCB Mounting Holes (Top View)**  
Tolerance:  $\pm 0.1$  mm

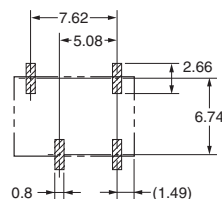

**Terminal Arrangement/ Internal Connections (Top View)**

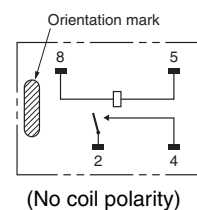

# Packaging

## ■ Tube Packaging

Relays in tube packaging are arranged so that the orientation mark of each Relay is on the left side.

Always confirm that the Relays are in the correct orientation when mounting the Relays to the PCBs.

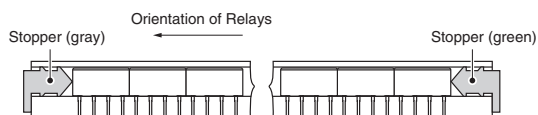

Tube length: 552 mm (stopper not included)  
No. of Relays per tube: 50

## ■ Tape and Reel Packaging (Surface-mount models)

When ordering Relays in tape and reel packaging, add the suffix "-TR" to the model number, otherwise the Relays in tube packaging will be provided.

- Relays per reel: 1,000

### 1. Direction of Relay Insertion

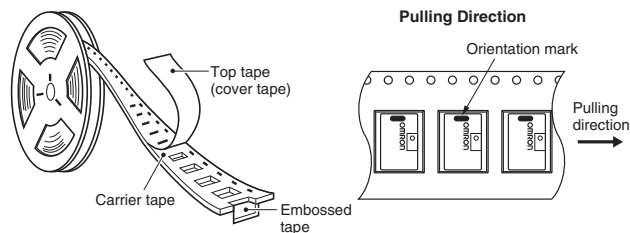

### 2. Reel Dimensions

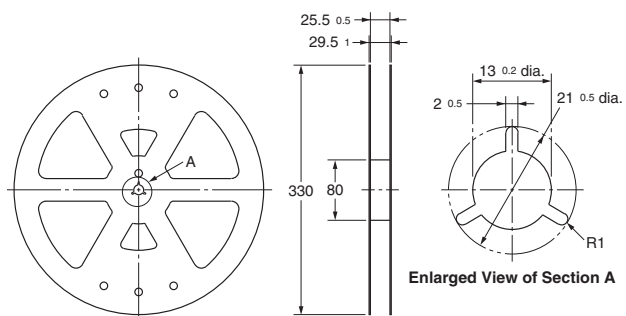

### G6L-1F

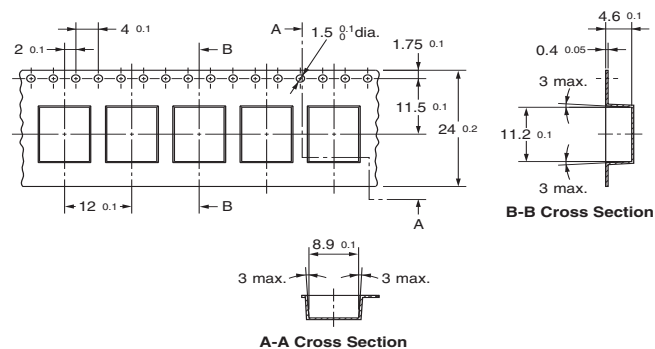

### 3. Carrier Tape Dimensions

# Recommended Soldering Method

## IRS Methods (for Surface-mounting Terminal Relays)

### IRS Method (Mounting Solder: Lead)

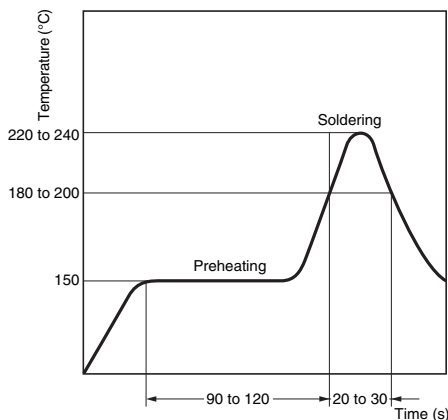

- The thickness of cream solder to be applied should be between 150 and 200 μm on OMRON's recommended PCB pattern.
- In order to perform correct soldering, it is recommended that the correct soldering conditions be maintained as shown below on the left-hand side.

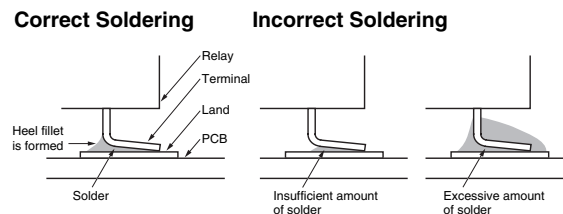

Visually check that the Relay is properly soldered.

**Note:** The temperature profile indicates the temperature on the circuit board.

### IRS Method (Mounting Solder: Lead-free)

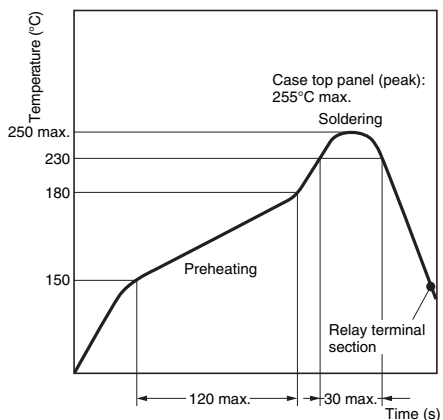

**Note:** The temperature profile indicates the temperature on the PCB.

## Approved Standards

UL Recognized (File No. E41515) / CSA Certified (File No. LR31928) - - Ambient Temp. = 40°C

Contact form	Coil rating	Contact rating	Number of test operations
SPST-NO (1a)	3 to 24 VDC	1A at 30 VDC (Resistive) 0.5A at 60 VDC (Resistive) 0.3A at 125 VAC (General Use)	6,000

# Precautions

Be sure to read the precautions and information common to all Electromechanical Relays, contained in the Technical User's Guide, "Electromechanical Relays, Technical Information", for correct use.

## ■ Correct Use

### Long-term Continuously ON Contacts

Using the Relay in a circuit where the Relay will be ON continuously for long periods (without switching) can lead to unstable contacts because the heat generated by the coil itself will affect the insulation, causing a film to develop on the contact surfaces. Be sure to use a fail-safe circuit design that provides protection against contact failure or coil burnout.

### Handling

Use the relay as soon as possible after opening the moisture-proof package. If the relay is left for a long time after opening the moisture-proof package, the appearance may suffer and seal failure may occur after the solder mounting process. To store the relay after opening the moisture-proof package, place it into the original package and seal the package with adhesive tape.

When washing the product after soldering the relay to a PCB, use a water-based solvent or alcohol-based solvent, and keep the solvent temperature to less than 40°C. Do not put the relay in a cold cleaning bath immediately after soldering.

### Claw Securing Force During Automatic Insertion

During automatic insertion of Relays, make sure to set the securing force of the claws to the following values so that the Relay characteristics will be maintained.

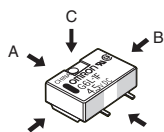

Direction A: 5.0 N max.  
Direction B: 5.0 N max.  
Direction C: 5.0 N max.

Secure the claws to the area indicated by shading.  
Do not attach them to the center area or to only part of the Relay.

### Environmental Conditions During Operation, Storage, and Transportation

Protect the Relays from direct sunlight and keep the Relays under normal temperature, humidity, and pressure.

### Maximum Voltage

The maximum voltage of the coil can be obtained from the coil temperature increase and the heat-resisting temperature of coil insulating sheath material. (Exceeding the heat-resisting temperature may result in burning or short-circuiting). The maximum voltage also involves important restrictions which include the following:

- Must not cause thermal changes in or deterioration of the insulating material.
- Must not cause damage to other control devices.
- Must not cause any harmful effect on people.
- Must not cause fire.

Therefore, be sure not to exceed the maximum voltage specified in the catalog.

As a rule, the rated voltage must be applied to the coil. A voltage exceeding the rated value, however, can be applied to the coil provided that the voltage is less than the maximum voltage. It must be noted that continuous voltage application to the coil will cause a coil temperature increase thus affecting characteristics such as electrical life and resulting in the deterioration of coil insulation.

### Coating

Relays mounted on PCBs may be coated or washed. Do not apply silicone coating or detergent containing silicone, otherwise the silicone coating or detergent may remain on the surface of the Relays.

### Coil Power Supply Waveform

If the voltage applied to the coil is increased or decreased gradually, operating characteristics may be unstable, contact endurance may decline, or the Relay may not function at its full performance level. Therefore, always use an instantaneous ON and instantaneous OFF when applying the voltage. Be sure that the rated voltage or zero voltage is reached within 1 ms.



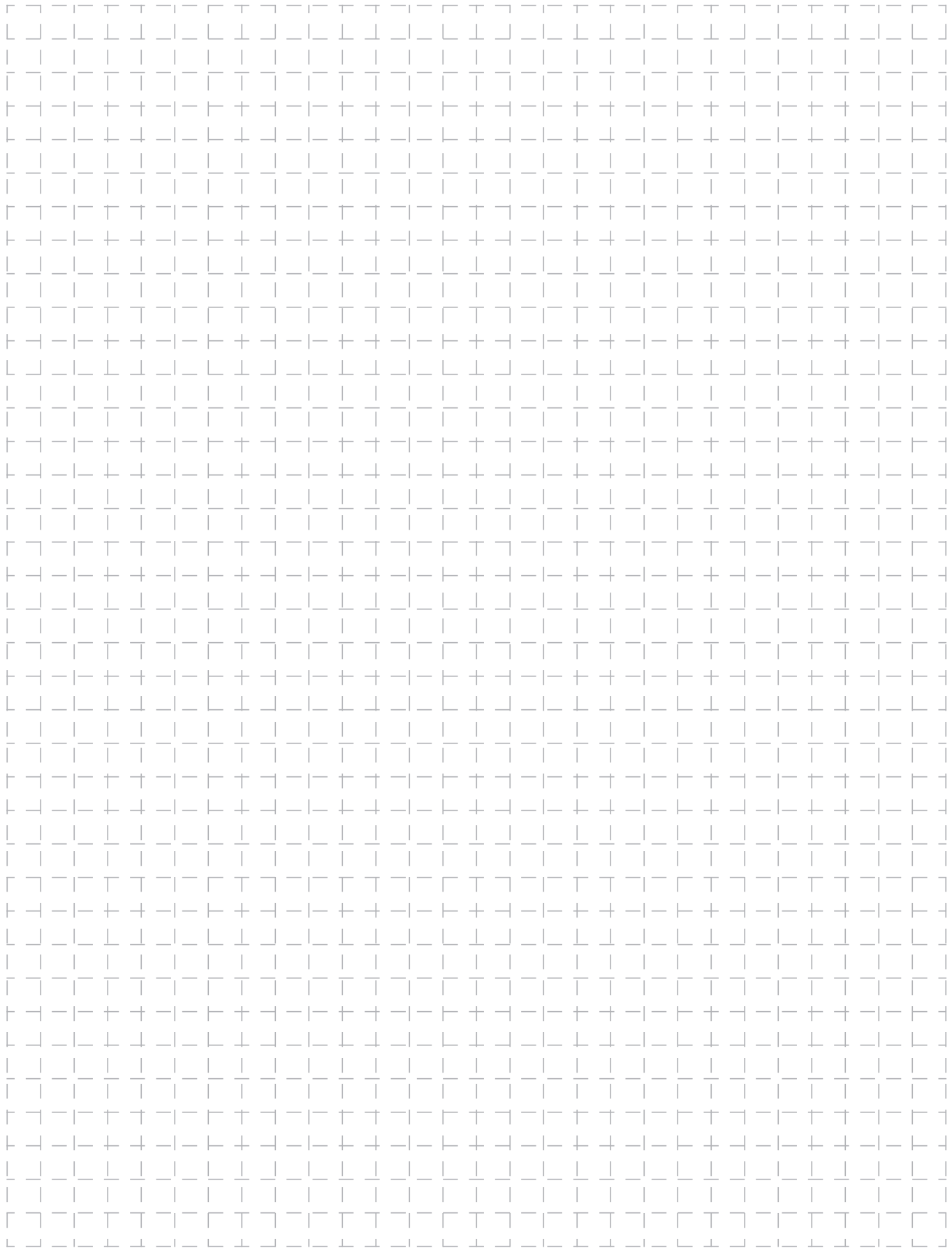

All sales are subject to Omron Electronic Components LLC standard terms and conditions of sale, which can be found at [http://www.components.omron.com/components/web/webfiles.nsf/sales\\_terms.html](http://www.components.omron.com/components/web/webfiles.nsf/sales_terms.html)

**ALL DIMENSIONS SHOWN ARE IN MILLIMETERS.**

To convert millimeters into inches, multiply by 0.03937. To convert grams into ounces, multiply by 0.03527.

**OMRON**<sup>®</sup>  
**OMRON ELECTRONIC  
COMPONENTS LLC**  
**847-882-2288**

**OMRON ON-LINE**

Global - <http://www.omron.com>

USA - <http://www.components.omron.com>

Cat. No. K119-E-04

06/14

Specifications subject to change without notice

Printed in USA