

Power PCB Relay G6C

SPST-NO Type Breaks 10-A Loads; SPST-NO + SPST-NC Breaks 8-A Load

- Compact: 20 x 15 x 10 mm (L x W x H).
- Low power consumption: 200 mW.
- Semi-sealed or fully sealed construction available.
- Unique moving loop armature reduces relay size, magnetic interference, and contact bounce.
- Single and Dual coil latching types also available
- RoHS Compliant

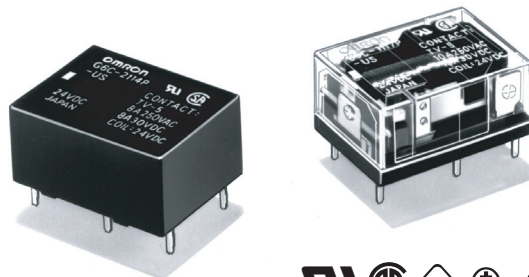

Ordering Information

Classification	Contact form	Straight Through-hole PCB		Self-clinching Through-hole PCB	
		Semi-sealed	Fully sealed	Semi-sealed	Fully sealed
Non-latching	SPST-NO	G6C-1117P-US	G6C-1114P-US	G6C-1117C-US	G6C-1114C-US
	SPST-NO + SPST-NC	G6C-2117P-US	G6C-2114P-US	G6C-2117C-US	G6C-2114C-US
Single coil latching	SPST-NO	G6CU-1117P-US	G6CU-1114P-US	G6CU-1117C-US	G6CU-1114C-US
	SPST-NO + SPST-NC	G6CU-2117P-US	G6CU-2114P-US	G6CU-2117C-US	G6CU-2114C-US
Dual coil latching	SPST-NO	G6CK-1117P-US	G6CK-1114P-US	G6CK-1117C-US	G6CK-1114C-US
	SPST-NO + SPST-NC	G6CK-2117P-US	G6CK-2114P-US	G6CK-2117C-US	G6CK-2114C-US

Note: When ordering, add the rated coil voltage to the model number.

Example: G6C-1117P-US DC12

Rated coil voltage

Model Number Legend

G6C - - - DC
 1 2 3 4 5 6 7 8

1. Relay Function

- None: Non-latching
- U: Single coil latching
- K: Dual coil latching

2. Contact Form

- 11: SPST-NO
- 21: SPST-NO + SPST-NC

3. Contact Type

- 1: Standard

4. Enclosure Ratings

- 4: Fully sealed
- 7: Semi-sealed

5. Terminals

- P: Straight Through-hole PCB
- C: Self-clinching Through-hole PCB

6. Approved Standards

- US: UL/CSA certified

7. Mounting Method

- None: Mount directly to PCB
- P6C: Mount to Socket

8. Rated Coil Voltage

- 3, 5, 6, 12, or 24 VDC

■ Accessories (Order Separately)

Back Connecting Sockets

Applicable Relay	Back Connecting Socket (See note 1.)
G6C(U)-1114P-US-P6C G6C(U)-1117P-US-P6C G6C(U)-2114P-US-P6C G6C(U)-2117P-US-P6C	P6C-06P
G6CK-1114P-US-P6C G6CK-1117P-US-P6C G6CK-2114P-US-P6C G6CK-2117P-US-P6C	P6C-08P

- Note:** 1. Not applicable to the self-clinching versions.
The operating current for the socket is 5 A max.
2. Use the G6C(U)-□□□□P-US-**P6C** if mounting relays in a P6C Socket.

Removal Tool	P6B-Y1
Hold-down Clips	P6B-C2

Specifications

■ Contact Ratings

Item	SPST-NO		SPST-NO+SPST-NC	
	Resistive load ($\cos\phi = 1$)	Inductive load ($\cos\phi = 0.4$; L/R = 7 ms)	Resistive load ($\cos\phi = 1$)	Inductive load ($\cos\phi = 0.4$; L/R = 7 ms)
Rated load	10 A at 250 VAC; 10A at 30 VDC	5 A at 250 VAC; 5 A at 30 VDC	8 A at 250 VAC; 8A at 30 VDC	3.5 A at 250 VAC; 3.5 A at 30 VDC
Contact material	Ag Alloy (Cd free)			
Rated carry current	10 A		8 A	
Max. switching voltage	380 VAC, 125 VDC (the case of latching 250 VAC, 125 VDC)			
Max. switching current	10 A		8 A	
Max. switching capacity	2,500 VA, 300 W	1,250 VA, 220 W	2,000 VA, 240 W	875 VA, 170 W
Min. permissible load (reference value - see note)	10 mA at 5 VDC			

Note: P level: $\lambda_{60} = 0.1 \times 10^{-6}$ operations

■ Coil Data

Non-latching

Rated voltage (VDC)	Rated current (mA)	Coil resistance (Ω)	Coil inductance (ref. value) (H)		Pick-up voltage	Dropout voltage	Maximum voltage	Power consumption (mW)
			Armature OFF	Armature ON				
3	67	45	0.078	0.067	70% max.	10% min.	160% max. at 23°C	Approx. 200
5	40	125	0.22	0.18				
6	33.30	180	0.36	0.29				
12	16.70	720	1.32	1.13				
24	8.30	2,880	4.96	4.19				

- Note:** 1. The rated current and coil resistance are measured at a coil temperature of 23°C with a tolerance of $\pm 10\%$.
2. Operating characteristics are measured at a coil temperature of 23°C.

Single Coil Latching Type

Rated voltage (VDC)	Rated current (mA)	Coil resistance (Ω)	Coil inductance (ref. value) (H)		Set pick-up voltage	Reset pick-up voltage	Maximum voltage	Power consumption (mW)
			Armature OFF	Armature ON	% of rated voltage			
3	67	45	0.09	0.06	70% max.	70% min.	160% max. at 23°C	Approx. 200
5	40	125	0.25	0.20				
6	33.30	180	0.36	0.24				
12	16.70	720	1.75	1.17				
24	8.30	2,880	5.83	3.84				

Dual Coil Latching Type

Rated voltage (VDC)	Rated current (mA)	Coil resistance (Ω)	Coil inductance (ref. value) (H)				Set pick-up voltage	Reset pick-up voltage	Maximum voltage	Power consumption (mW)
			Set Coil		Reset Coil					
			Armature OFF	Armature ON	Armature OFF	Armature ON	% of rated voltage			
3	93.50	32.10	0.03	0.02	0.03	0.02	70% max.	70% max.	130% max. at 23°C)	Approx. 280
5	56	89.30	0.07	0.06	0.08	0.07				
6	46.70	129	0.10	0.08	0.12	0.10				
12	23.30	514	0.37	0.32	0.47	0.38				
24	11.70	2,056	1.56	1.18	1.46	1.13				

- Note:** 1. The rated current and coil resistance are measured at a coil temperature of 23°C with a tolerance of ±10%.
 2. Operating characteristics are measured at a coil temperature of 23°C.
 3. The minimum pulse width of the set and reset voltage is 20 ms.

■ Characteristics

Contact resistance		30 mΩ max.
Operate (set) time		10 ms max. (mean value: approx. 5 ms)
Release (reset) time		10 ms max. (mean value: approx. 2 ms; latching types: mean value: approx. 5 ms)
Bounce time		5 ms max. (Approx. 3 ms typical)
Min. set/reset signal width		Latching type: 20 ms (at 23°C)
Max. switching frequency	Mechanical	18,000 operations/hr
	Electrical	1,800 operations/hr (under rated load)
Insulation resistance		1,000 MΩ min. (at 500 VDC, at 250 VDC between set coil and reset coil)
Dielectric strength		2,000 VAC, 50/60 Hz for 1 min between coil and contacts 2,000 VAC, 50/60 Hz for 1 min between contacts of different polarity 1,000 VAC, 50/60 Hz for 1 min between contacts of same polarity 250 VAC, 50/60 Hz for 1 min between set and reset coils (double winding latching type)
Surge withstand voltage		6,000 V (1.2 x 50 μs) between coil and contacts (latching types: 4,500 V, 1.2 x 50 μs)
Vibration resistance	Mechanical durability	10 to 55 Hz, 1.5-mm double amplitude
	Malfunction durability	10 to 55 Hz, 1.5-mm double amplitude
Shock resistance	Mechanical durability	1,000 m/s ² (Approx. 100G)
	Malfunction durability	100 m/s ² (Approx. 10G)
Ambient temperature		Operating: -25°C to 70°C (with no icing)
Ambient humidity		Operating: 5% to 85%
Service Life	Mechanical:	50,000,000 operations min. (at 18,000 operations/hr)
	Electrical:	100,000 operations min. (at 1,800 operations/hr) See "Characteristic Data"
Weight		Approx. 5.6 g

■ Approved Standards

UL Recognized (File No. E41643) -- See note

Model	Contact form	Coil rating	Contact rating
G6C-1114P-US G6C-1114C-US G6C-1117P-US G6C-1117C-US	SPST-NO	3 to 60 VDC	10 A, 250 VAC (general use) 10 A, 30 VDC (resistive load) 1/6 hp, 125 VAC 1/4 hp, 125 VAC 1/4 hp, 250 VAC 1/3 hp, 250 VAC TV-5 (40°C, 25,000 operations) 600 W, 120 VAC (tungsten) 530 VA, 20 to 265 VAC, 2 A max. (pilot duty) 43.2 VA, 30 VDC (pilot duty) 12LRA, 2.2FLA, 30 VDC (30,000 operations)
G6C-2114P-US G6C-2114C-US G6C-2117P-US G6C-2117C-US	SPST-NO + SPST-NC		8 A, 250 VAC (general use) 8 A, 30 VDC (resistive load) 1/6 hp, 125 VAC 1/4 hp, 125 VAC 1/4 hp, 250 VAC 1/3 hp, 250 VAC TV-5 (40°C, 25,000 operations) 600 W, 120 VAC (tungsten) 530 VA, 20 to 265 VAC, 2 A max. (pilot duty) 43.2 VA, 30 VDC (pilot duty) 12LRA, 2.2FLA, 30 VDC (30,000 operations)

Note: UL Recognition tests performed at 80°C for 6,000 operations unless otherwise specified.

CSA Certified (File No. LR31928)

Model	Contact form	Coil rating	Contact rating
G6C-1114P-US G6C-1114C-US G6C-1117P-US G6C-1117C-US	SPST-NO	3 to 60 VDC	10 A, 250 VAC (general use) 10 A, 30 VDC (resistive load) 1/6 hp, 125 VAC 1/4 hp, 125 VAC 1/4 hp, 250 VAC 1/3 hp, 250 VAC TV-5 600 W, 120 VAC (tungsten)
G6C-2114P-US G6C-2114C-US G6C-2117P-US G6C-2117C-US	SPST-NO + SPST-NC	3 to 60 VDC	8 A, 250 VAC (general use) 8 A, 30 VDC (resistive load) 1/6 hp, 125 VAC 1/4 hp, 125 VAC 1/4 hp, 250 VAC TV-5 600 W, 120 VAC (tungsten)

VDE (Approval No. 2413) EN61810-1

Model	Contact form	Coil rating	Contact rating	Number of test operations
G6C-1114P-US G6C-1114C-US G6C-1117P-US G6C-1117C-US	SPST-NO	3, 12, 24 VDC	10 A, 250 VAC ($\cos\phi = 1$) 5 A, 250 VAC ($\cos\phi = 0.4$)	100,000 operations
G6C-2114P-US G6C-2114C-US G6C-2117P-US G6C-2117C-US	SPST-NO + SPST-NC	Single-stable: 3, 5, 12, 24 VDC Latching: 5 VDC G6CU-2117P-VD: 3 VDC	7 A, 250 VAC ($\cos\phi = 1$) 3.5 A, 250 VAC ($\cos\phi = 0.4$)	100,000 operations

Engineering Data

Maximum Switching Capacity SPST-NO



SPST-NO + SPST-NC



Service Life

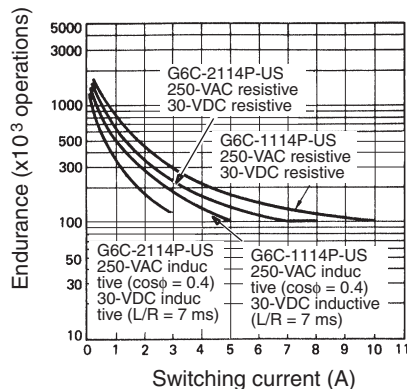

Ambient Temperature vs. Maximum Coil Voltage

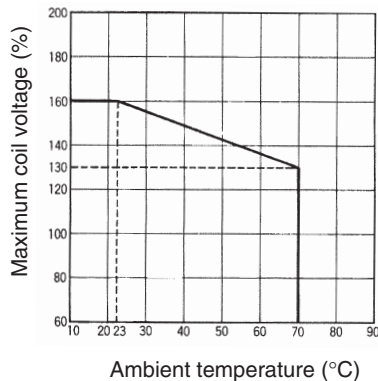

Note: The maximum coil voltage refers to the maximum value in a varying range of operating power voltage, not a continuous voltage.

Dimensions

Note: 1. All units are in millimeters unless otherwise indicated.

2. Orientation mark is indicated as follows: 

■ Non-latching

G6C-□117P-US



*Average value

G6C-1117P-US, G6C-1117C-US G6C-1114P-US, G6C-1114C-US Terminal Arrangement/Internal Connections (Bottom View)

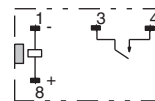

Mounting Holes (Bottom View)

Tolerance: ±0.1

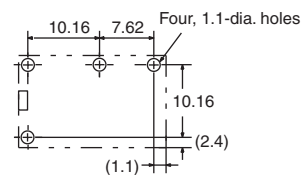

G6C-□117C-US

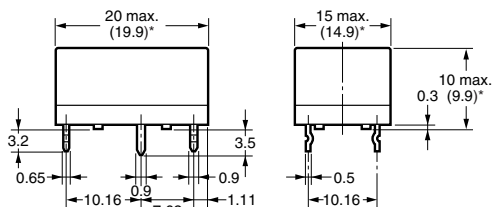
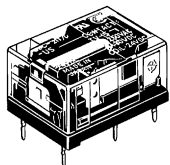

*Average value

G6C-□114P-US

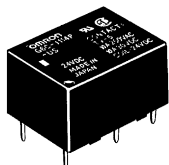

*Average value

G6C-2117P-US, G6C-2117C-US G6C-2114P-US, G6C-2114C-US Terminal Arrangement/Internal Connections (Bottom View)

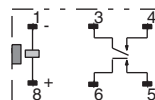

Mounting Holes (Bottom View)

Tolerance: ±0.1

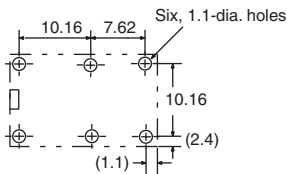

G6C-□114C-US

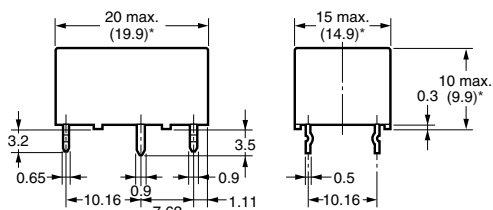
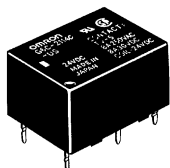

*Average value

Single Coil Latching

G6CU-□117P-US

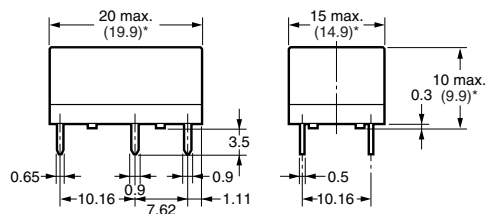

*Average value

G6CU-1117P-US, G6CU-1117C-US
G6CU-1114P-US, G6CU-1114C-US
Terminal Arrangement/Internal Connections (Bottom View)



Mounting Holes (Bottom View)

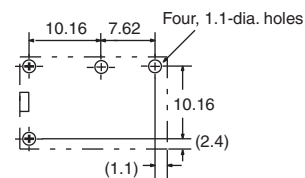

G6CU-□117C-US

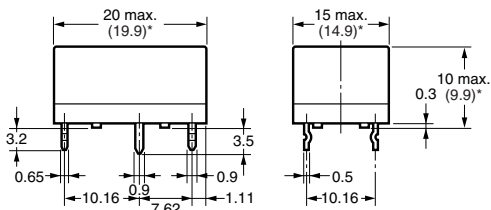

*Average value

G6CU-□114P-US

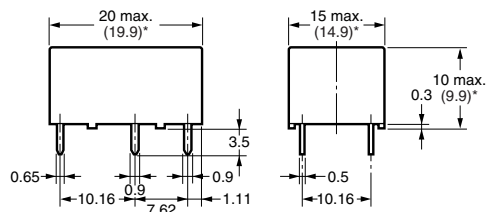

*Average value

G6CU-2117P-US, G6CU-2117C-US
G6CU-2114P-US, G6CU-2114C-US
Terminal Arrangement/Internal Connections (Bottom View)



Mounting Holes (Bottom View)

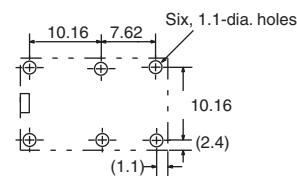

G6CU-□114C-US

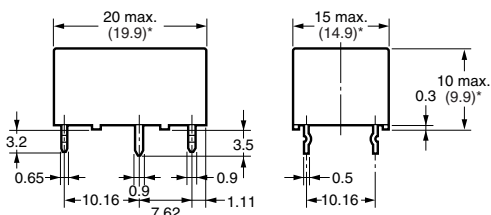

*Average value

■ Dual Coil Latching

G6CK-□117P-US



*Average value

G6CK-1117P-US, G6CK-1117C-US G6CK-1114P-US, G6CK-1114C-US Terminal Arrangement/Internal Connections (Bottom View)



Mounting Holes (Bottom View)



G6CK-□117C-US



*Average value

G6CK-□114P-US

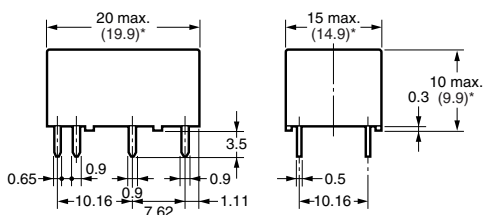
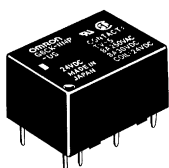

*Average value

G6CK-2117P-US, G6CK-2117C-US G6CK-2114P-US, G6CK-2114C-US Terminal Arrangement/Internal Connections (Bottom View)



Mounting Holes (Bottom View)

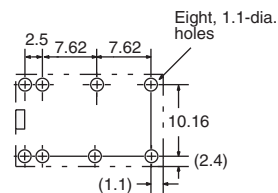

G6CK-□114C-US

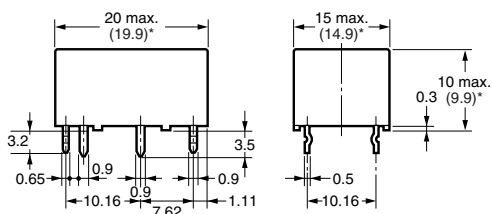
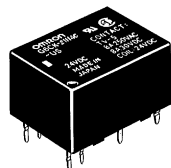

*Average value

Accessories

Back Connecting Sockets

P6C-06P

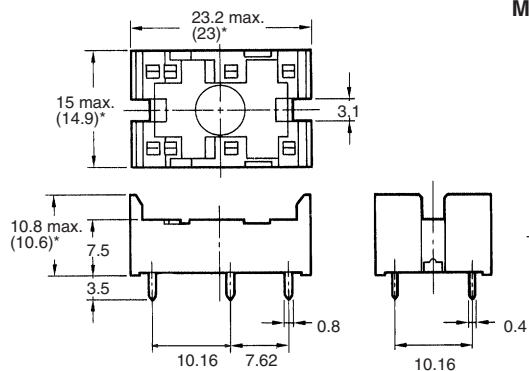

Mounting Holes (Bottom View)

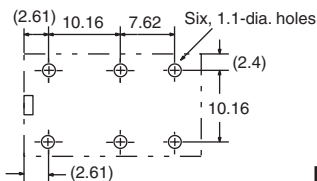

Mounting Height of Relay with Connecting Socket

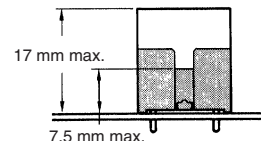

*Average value

P6C-08P



Mounting Holes (Bottom View)

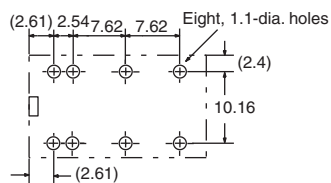

*Average value

Note: Rated current of socket max. 5 A

Removal Tool

P6B-Y1



Hold-down Clips

P6B-C2



All sales are subject to Omron Electronic Components LLC standard terms and conditions of sale, which can be found at http://www.components.omron.com/components/web/webfiles.nsf/sales_terms.html

ALL DIMENSIONS SHOWN ARE IN MILLIMETERS.

To convert millimeters into inches, multiply by 0.03937. To convert grams into ounces, multiply by 0.03527.

OMRON[®]

**OMRON ELECTRONIC
COMPONENTS LLC**

55 E. Commerce Drive, Suite B
Schaumburg, IL 60173

847-882-2288

OMRON ON-LINE

Global - <http://www.omron.com>

USA - <http://www.components.omron.com>

Cat. No. X301-E-1b

09/11

Specifications subject to change without notice

Printed in USA