

Power PCB Relay G6B

Subminiature Relay that Switches up to 5 A

- Subminiature: 20 x 10 x 10 mm (L x W x H).
- Low power consumption: 200 mW.
- Unique moving loop armature reduces relay size, magnetic interference, and contact bounce time.
- Fully sealed construction
- Single and Dual coil latching types also available.
- High Capacity versions available
- RoHS Compliant

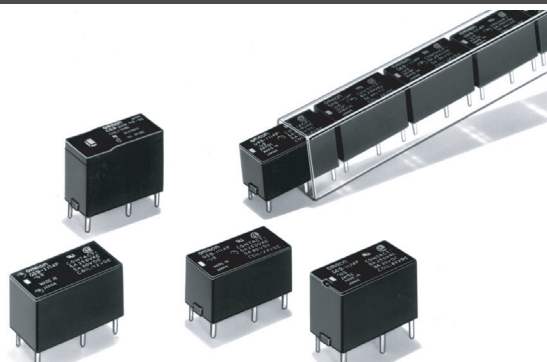

Ordering Information

Classification	Contact form	Straight Through-hole PCB	Self-clinching Through-hole PCB
Non-latching	SPST-NO	G6B-1114P-US	G6B-1114C-US
	SPST-NO+SPST-NC	G6B-2114P-US	G6B-2114C-US
	DPST-NO	G6B-2214P-US	G6B-2214C-US
	DPST-NC	G6B-2014P-US	G6B-2014C-US
Single coil latching	SPST-NO	G6BU-1114P-US	G6BU-1114C-US
Dual coil latching	SPST-NO	G6BK-1114P-US	G6BK-1114C-US
High-capacity, Non-latching	SPST-NO	G6B-1174P-US	G6B-1174C-US

Note: When ordering, add the rated coil voltage to the model number.

Example: G6B-1114P-US DC12

Rated coil voltage

Model Number Legend

G6B - - - DC

1 2 3 4 5 6 7 8

1. Relay Function

- None: Non-latching
- U: Single coil latching
- K: Dual coil latching

2. Contact Form

- 21: SPST-NO + SPST-NC
- 22: DPST-NO
- 20: DPST-NC
- 11: SPST-NO

3. Contact Type

- 1: Standard
- 7: High-capacity

4. Enclosure Ratings

- 4: Fully sealed

5. Terminals

- P: Straight Through-hole PCB
- C: Self-clinching Through-hole PCB

6. Approved Standards

- US: UL/CSA certified

7. Mounting Method

- None: Mount directly to PCB
- P6B: Mount to Socket

8. Rated Coil Voltage

- 5, 6, 12, or 24 VDC

■ Accessories (Order Separately)

Back Connecting Sockets

Applicable Relay	Back Connecting Socket (See note 1.)
G6B(U)-1114P-US-P6B	P6B-04P
G6BK-1114P-US-P6B	P6B-06P
G6B-2□□4P-US-P6B	P6B-26P
G6B-1174P-US-P6B	P6B-04P

- Note:** 1. Not applicable to the self-clinching type.
 2. Use the G6B-□□□□P-US-**P6B** if mounting relays in a P6B Socket.

Removal Tool	P6B-Y1
Hold-down Clips	P6B-C2

Specifications

■ Contact Ratings

Item	SPST-NO		SPST-NO + SPST-NC, DPST-NO, DPST-NC	
	Resistive load (cosφ = 1)	Inductive load (cosφ = 0.4; L/R = 7 ms)	Resistive load (cosφ = 1)	Inductive load (cosφ = 0.4; L/R = 7 ms)
Rated load	5 A at 250 VAC; 5A at 30 VDC	2 A at 250 VAC; 2 A at 30 VDC	5 A at 250 VAC; 5A at 30 VDC	1.5 A at 250 VAC; 1.5 A at 30 VDC
Contact material	Ag Alloy (Cd free)			
Rated carry current	5 A			
Max. switching voltage	380 VAC, 125 VDC			
Max. switching current	5 A			
Max. switching capacity	1,250 VA, 150 W	500 VA, 60 W	1,250 VA, 150 W	375 VA, 80 W
Min. permissible load (reference value - see note)	10 mA at 5 VDC			

Item	SPST-NO (High-capacity)	
Load	Resistive load (cosφ = 1)	Inductive load (cosφ = 0.4; L/R = 7 ms)
Rated load	8 A at 250 VAC; 8 A at 30 VDC	2 A at 250 VAC; 2 A at 30 VDC
Contact material	Ag Alloy (Cd free)	
Rated carry current	8 A	
Max. switching voltage	380 VAC, 125 VDC	
Max. switching current	8 A	
Max. switching capacity	2,000 VA, 150 W	
Min. permissible load (reference value - see note)	10 mA at 5 VDC	

Note: P level: $\lambda_{60} = 0.1 \times 10^{-6}$ /operation

■ Coil Ratings

Non-latching, Single Pole

Rated voltage (VDC)	Rated current (mA)	Coil resistance (Ω)	Coil inductance (ref. value)(H)		Pick-up voltage	Dropout voltage	Max. voltage	Power consumption (mW)
			Armature OFF	Armature ON				
5	40	125	0.28	0.26	70% max.	10% min.	160% max. @ 23°C	Approx. 200
6	33.30	180	0.31	0.28				
12	16.70	720	1.2	1.1				
24	8.30	2,880	4.9	4.1				

- Note:** 1. The rated current and coil resistance are measured at a coil temperature of 23°C with a tolerance of ±10%.
 2. Operating characteristics are measured at a coil temperature of 23°C.

Non-latching, Double Pole

Rated voltage (VDC)	Rated current (mA)	Coil resistance (Ω)	Pick-up voltage	Dropout voltage	Max. voltage	Power consumption (mW)
			% of rated voltage			
5	60	83.30	80% max.	10% min.	140% max. @ 23°C	Approx. 300
6	50	120				
12	25	480				
24	12.50	1,920				

Single Coil Latching

Rated voltage (VDC)	Rated current (mA)	Coil resistance (Ω)	Coil inductance (ref. value) (H)		Set pick-up voltage	Reset pick-up voltage	Maximum voltage	Power consumption (mW)
			Armature OFF	Armature ON	% of rated voltage			
5	40	125	0.28	0.26	70% max.	70% max.	160% max. at 23°C	Approx. 200
6	33.30	180	0.31	0.28				
12	16.70	720	1.2	1.10				
24	8.30	2,880	4.9	4.10				

Dual Coil Latching

Rated voltage (VDC)	Rated current (mA)	Coil resistance (Ω)	Coil inductance (ref. value) (H)		Set pick-up voltage	Reset pick-up voltage	Maximum voltage	Power consumption (mW)
			Armature OFF	Armature ON	% of rated voltage			
5	56	89.20	0.15	0.15	70% max.	70% max.	130% max. at 23°C	Approx. 280
6	46.80	128.50	0.18	0.18				
12	23.30	515	0.52	0.52				
24	11.70	2,060	1.20	1.20				

Note: 1. The rated current and coil resistance are measured at a coil temperature of 23°C with a tolerance of ±10%.
 2. Operating characteristics are measured at a coil temperature of 23°C.

■ Characteristics

Contact resistance		30 mΩ max.
Operate (set) time		10 ms max. (mean value: 1-pole approx. 3 ms, 2-pole approx. 4 ms)
Release (reset) time	Non-latching	10 ms max. (mean value: 1-pole approx. 1 ms, 2-pole approx. 2 ms)
	Latching	10 ms max. (mean value: approx. 3 ms)
Min. set/reset signal width		Latching type: 15 ms min. (at 23°C)
Max. operating frequency	Mechanical	18,000 operations/hr
	Electrical	1,800 operations/hr (under rated load)
Insulation resistance		1,000 MΩ min. (at 500 VDC, at 250 VDC between set coil and reset coil)
Dielectric strength		3,000 VAC (Latching types: 2,000 VAC), 50/60 Hz for 1 min between coil and contacts 1,000 VAC, 50/60 Hz for 1 min between contacts of same polarity 250 VAC, 50/60 Hz for 1 min between set and reset coils 2,000 VAC, 50/60 Hz for 1 min between contacts of different polarity
Vibration resistance	Mechanical durability	10 to 55 Hz, 1.5-mm double amplitude
	Malfunction durability	10 to 55 Hz, 1.5-mm double amplitude
Shock resistance	Mechanical durability	1,000 m/s ² (Approx 100G)
	Malfunction durability	Single-side stable: 100 m/s ² (Approx 10G); Latching: 300 m/s ² (Approx 30G)
Service Life	Mechanical	50,000,000 operations min. (at 18,000 operations/hr)
	Electrical	100,000 operation min. (at 1,800 operations/hr)
Ambient temperature		Operating: -25°C to 70°C (with no icing)
Ambient humidity		Operating: 5% to 85%
Weight		Double-winding latching: Approx. 3.7 g High-capacity: Approx. 4.6 g Double pole: Approx. 4.5 g Other: Approx. 3.5 g

Note: The data shown above are initial values.

Approved Standards

UL Recognized (File No. E41643) / CSA Certified (File No. LR31928)

Model	Contact form	Coil rating	Contact rating
G6B-1114P-US G6B-1114C-US G6BU-1114P-US G6BU-1114C-US G6BK-1114C-US G6BK-1114C-US	SPST-NO	3 to 24 VDC	5 A at 250 VAC (General Use) 80°C 5 A at 30 VDC (Resistive) 80°C
G6B-1174P-US G6B-1174C-US			8 A at 250 VAC (General Use) 80°C 8 A at 30 VDC (Resistive) 80°C
G6B-2114P-US G6B-2114C-US G6B-2214P-US G6B-2214C-US G6B-2014P-US G6B-2014C-US	SPST-NO + SPST-NC DPST-NO DPST-NC		5 A at 250 VAC (general use) 40°C 5 A at 30 VDC (resistive load) 40°C

Engineering Data

G6B-1114P-US

Maximum Switching Capacity

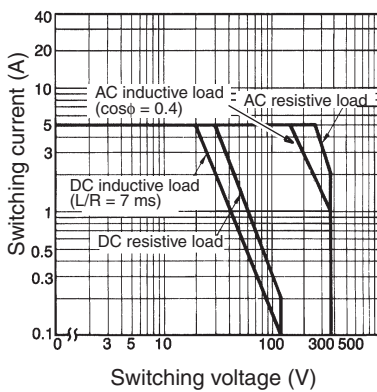

Electrical Service Life

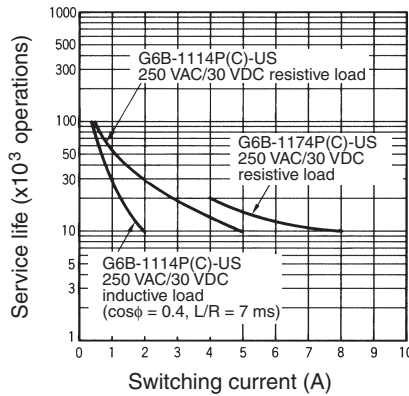

Ambient Temperature vs. Maximum Coil Voltage

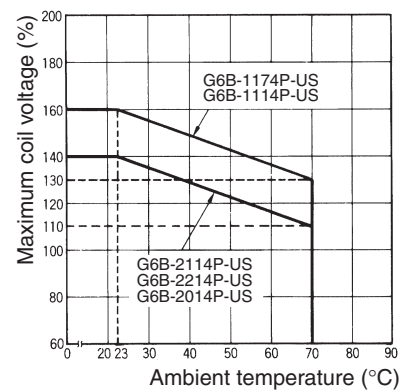

Note: The maximum coil voltage refers to the maximum value in a varying range of operating power voltage, not a continuous voltage.

G6B-2114P-US, G6B-2214P-US, G6B-2014P-US

Maximum Switching Capacity

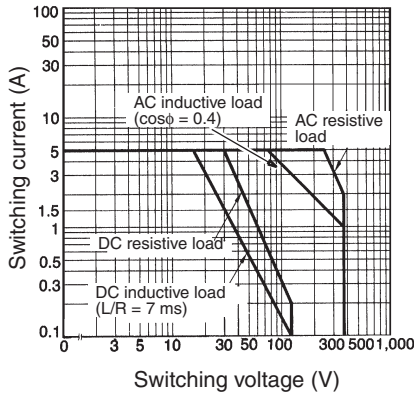

Electrical Service Life

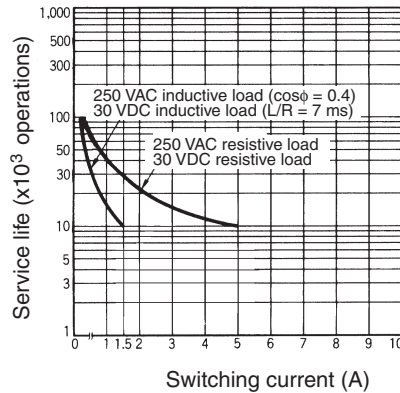

Dimensions

Note: 1. All units are in millimeters unless otherwise indicated.

2. Orientation marks are indicated as follows:

Single Pole

G6B-1114P-US
G6BU-1114P-US

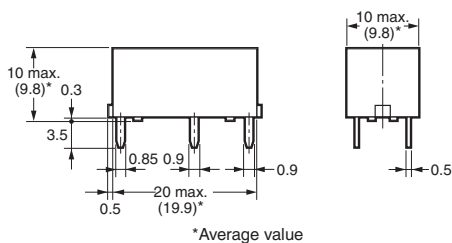
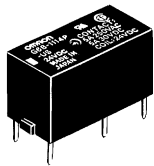

Terminal Arrangement/Internal Connections (Bottom View)
G6B-1114P, -1114C

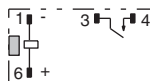

Mounting Holes (Bottom View)
G6B-1114P, -1114C
G6BU-1114P, -1114C

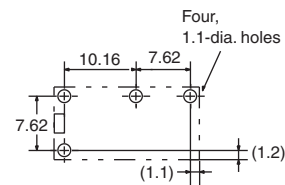

G6B-1114C-US
G6BU-1114C-US

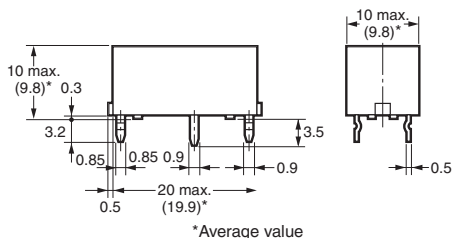
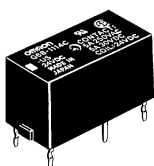

G6BU-1114P, -1114C

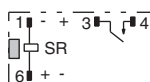

G6BK-1114P-US

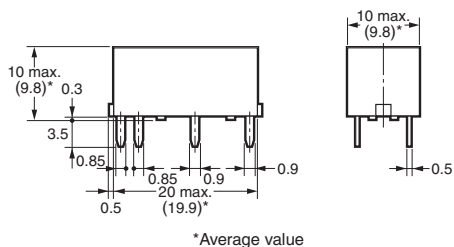
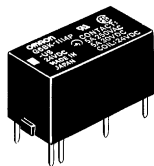

Terminal Arrangement/Internal Connections (Bottom View)
G6BK-1114P, -1114C

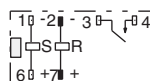

Mounting Holes (Bottom View)
G6BK-1114P, -1114C

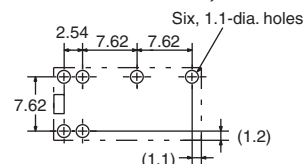

G6BK-1114C-US

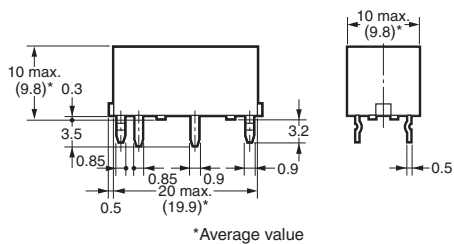
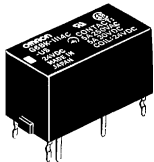

G6B-1174P-US

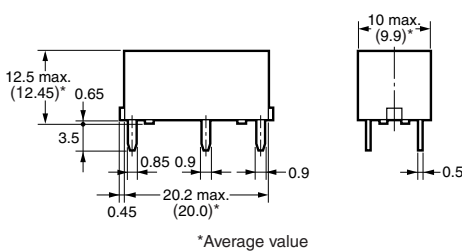
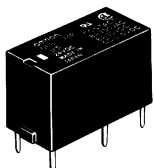

Terminal Arrangement/Internal Connections (Bottom View)
G6B-1174P, -1174C

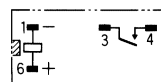

Mounting Holes (Bottom View)

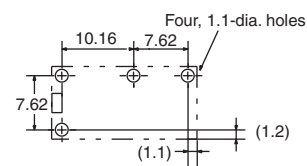

G6B-1174C-US

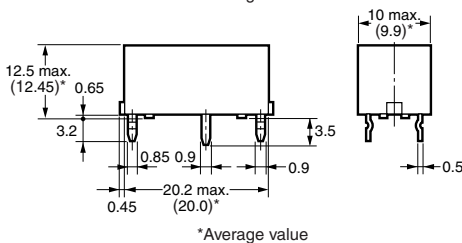
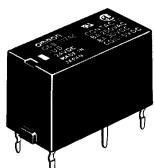

Double Pole

G6B-2114P-US
G6B-2214P-US
G6B-2014P-US

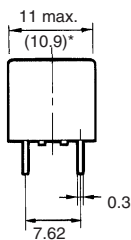
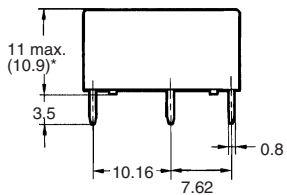
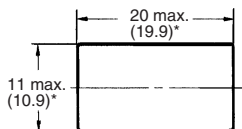
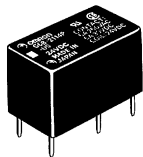

*Average value

Terminal Arrangement/Internal Connections (Bottom View)

G6B-2114P-US

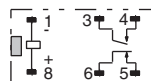

G6B-2214P-US

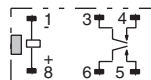

G6B-2014P-US

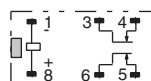

Mounting Holes (Bottom View)

Tolerance: ± 0.1

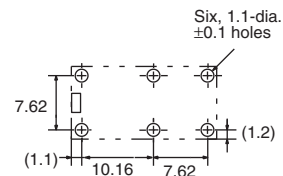

G6B-2114C-US
G6B-2214C-US
G6B-2014C-US

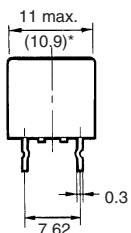
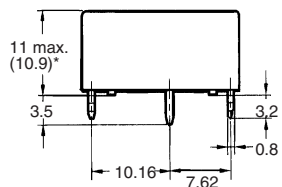
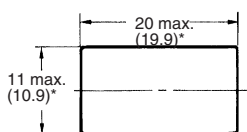
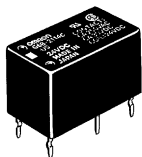

*Average value

Terminal Arrangement/Internal Connections (Bottom View)

G6B-2114C-US

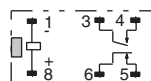

G6B-2214C-US

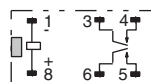

G6B-2014C-US

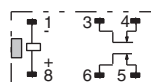

Mounting Holes (Bottom View)

Tolerance: ± 0.1

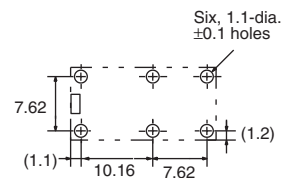

Accessories

Back Connecting Socket P6B-04P

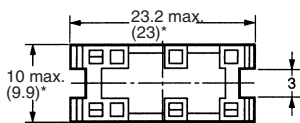
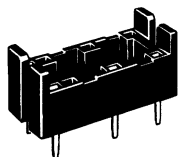

Mounting Holes (Bottom View)

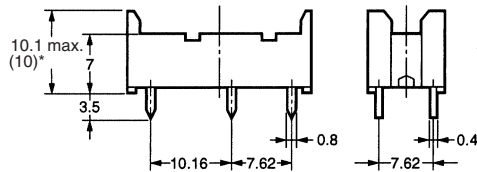
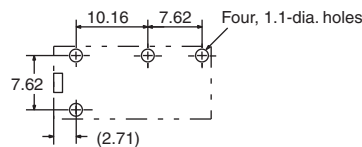

*Average value

P6B-06P

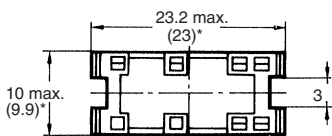
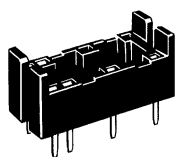

Mounting Holes (Bottom View)

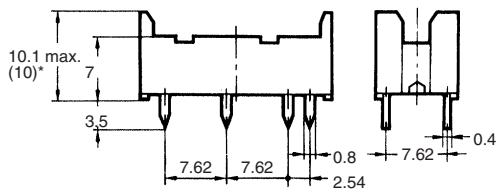
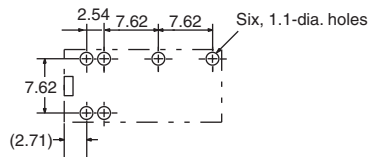

*Average value

P6B-26P

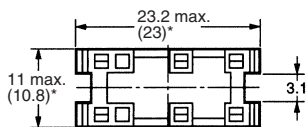
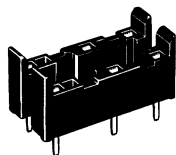

Mounting Holes (Bottom View)

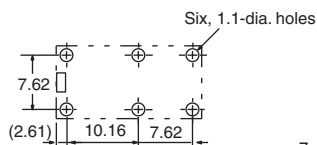

Mounting Height of Relay with Connecting Socket

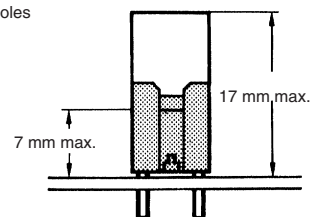

Note: Rated current of socket is 5 A max.

Note: Height of G6B-1174P-US is 19.5 mm max.

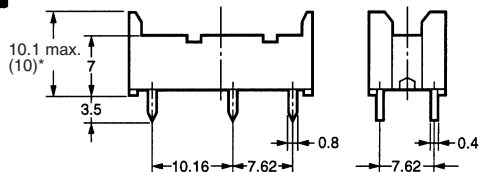

*Average value

Removal Tool P6B-Y1

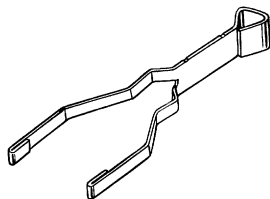

Hold-down Clips P6B-C2

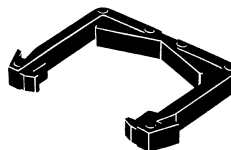

Note: P6B-C2 Hold-down Clips cannot be used for G6B-1174P-US.

All sales are subject to Omron Electronic Components LLC standard terms and conditions of sale, which can be found at http://www.components.omron.com/components/web/webfiles.nsf/sales_terms.html

ALL DIMENSIONS SHOWN ARE IN MILLIMETERS.

To convert millimeters into inches, multiply by 0.03937. To convert grams into ounces, multiply by 0.03527.

OMRON[®]

**OMRON ELECTRONIC
COMPONENTS LLC**

55 E. Commerce Drive, Suite B
Schaumburg, IL 60173

847-882-2288

OMRON ON-LINE

Global - <http://www.omron.com>

USA - <http://www.components.omron.com>

Cat. No. X301-E-1b

09/11

Specifications subject to change without notice

Printed in USA