

# Power PCB Relay G6D-ASI

- Reduced board space ideal for high-density mounting (45% smaller than the surface area of G6B).
- Slim package: measures 6.5 W x 17.5 L x 12.5 H mm
- Switches loads up to 5 A, 250 VAC/30 VDC.
- Sealed construction allows automatic soldering and cleaning.
- Long service life: up to 300,000 operations with a 2 A, 250 VAC/30 VDC load.
- Rated for D150 pilot duty by UL, CSA.
- Optional mounting socket simplifies relay installation and servicing of finished equipment.
- RoHS Compliant.

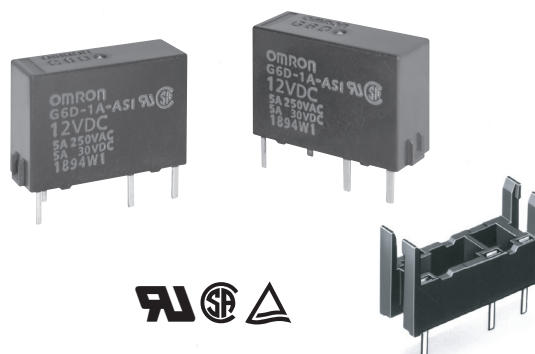

## Ordering Information

To Order: Select the part number and add the desired coil voltage rating, (e.g., G6D-1A-ASI-DC12).

Type	Contact form	Terminal	Construction	Model
Standard	SPST-NO	PCB	Fully sealed	G6D-1A-ASI

## Accessories

### Connecting Socket

Description	Model
PCB mount socket for G6D relay	P6D-04P

## Specifications

### Contact Data

Load	Resistive load (p.f. = 1)	Inductive load (p.f. = 0.40, L/R = 7 ms)
Rated load	5 A at 250 VAC, 30 VDC	2 A at 250 VAC, 30 VDC
Contact material	Ag alloy	
Carry current	5 A	
Max. operating voltage	250 VAC, 30 VDC	
Max. operating current	5 A	
Max. switching capacity	1,250 VA, 150 W	500 VA, 60 W
Min. permissible load	10 mA at 5 VDC	

Note: P level:  $\lambda_{60} = 0.1 \times 10^{-6}/\text{operation}$

## Coil Data

Rated voltage (VDC)	Rated current (mA)	Coil resistance ( $\Omega$ )	Pick-up voltage	Dropout voltage	Maximum voltage	Power consumption (mW)
			% of rated voltage			
5	40	125	70% max.	10% min.	160% at 23°C	Approx. 200
12	16.7	720				
24	8.3	2,880				

- Note:**
- The rated current and coil resistance are measured at a coil temperature of 23°C (73°F) with a tolerance of  $\pm 10\%$ .
  - Operating characteristics are measured at a coil temperature of 23°C (73°F).
  - The pick-up voltage is 75% or less of rated voltage if the relay is mounted upside down.

## Characteristics

<b>Contact resistance</b>		100 m $\Omega$ max.
<b>Operate time</b>		10 ms max.
<b>Release time</b>		5 ms max.
<b>Operating frequency</b>	<b>Mechanical</b>	18,000 operations/hour
	<b>Electrical</b>	1,800 operations/hour (under rated load)
<b>Insulation resistance</b>		1,000 M $\Omega$ min. (at 500 VDC)
<b>Dielectric strength</b>		3,000 VAC, 50/60 Hz for 1 minute between coil and contacts
		750 VAC, 50/60 Hz for 1 minute between contacts of the same polarity
<b>Surge withstand voltage</b>		6,000 V, 1.20 x 50 $\mu$ s between coil and contacts
<b>Vibration</b>	<b>Mechanical durability</b>	10 to 55 Hz, 1.50 mm (0.06 in) double amplitude
	<b>Malfunction durability</b>	10 to 55 Hz, 1.50 mm (0.06 in) double amplitude
<b>Shock</b>	<b>Mechanical durability</b>	1,000 m/s <sup>2</sup> (approx. 100 G)
	<b>Malfunction durability</b>	100 m/s <sup>2</sup> (approx. 10 G)
<b>Ambient temperature</b>	<b>Operating</b>	-25° to 70°C (-13° to 158°F)
<b>Humidity</b>		5% to 85% RH
<b>Life expectancy</b>	<b>Mechanical</b>	20 million operations min. (at operating frequency of 18,000 operations/hour)
	<b>Electrical</b>	70,000 operations min. at rated loads (300,000 operations min for 2A at 250 VAC, 30 VDC, resistive load)
<b>Weight</b>		Approx. 3 g (0.10 oz)

**Note:** Data shown are of initial value.

## Characteristic Data

Maximum Switching Capacity

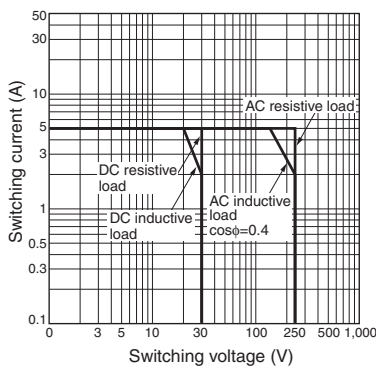

Life Expectancy

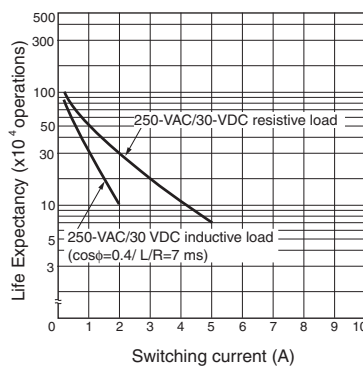

Ambient Temperature vs. Maximum Coil Voltage

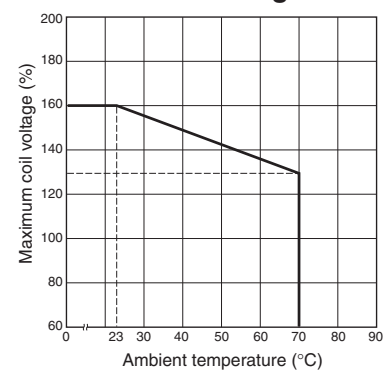

**Note:** The maximum coil voltage is the maximum voltage that can be applied to the relay coil.

### Ambient Temperature vs. Pickup and Drop out Voltage G6D-1A-ASI

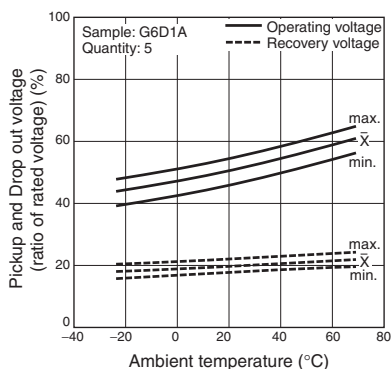

### Malfunctioning Shock G6D-1A-ASI

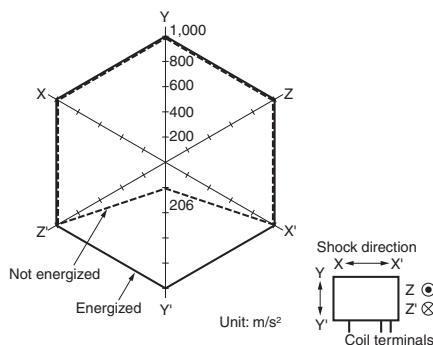

Measurement conditions: Impose a shock in the ±X, ±Y, and ±Z directions three times each with the Relay energized to check the shock values that cause the Relay to malfunction.

## Dimensions

Unit: mm

Note: Orientation marks are indicated as follows:

### Relays

#### G6D-1A-ASI

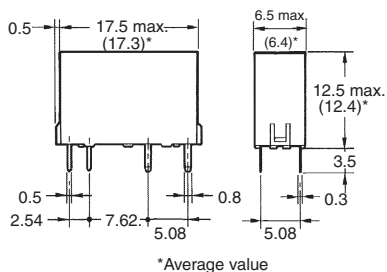
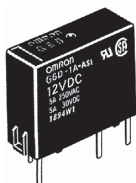

#### Terminal Arrangement/ Internal Connections (Bottom View)

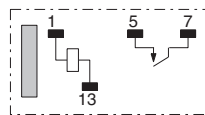

#### Mounting Holes (Bottom View)

Tolerance: ±0.1

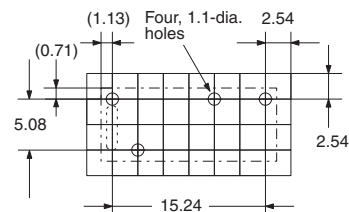

### Socket

#### P6D-04P

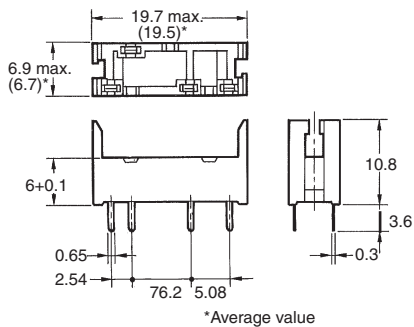
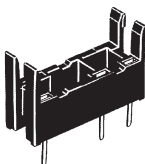

#### Mounting Holes (Bottom View)

Tolerance: ±0.1

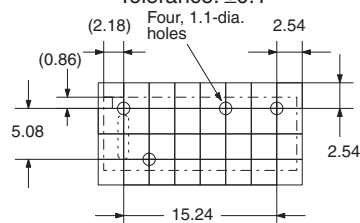

## ■ Approvals

• The rated values approved by each of the safety standards may be different from the performance characteristics individually defined in this catalog.

### UL Recognized (File No. E41515) - - Ambient Temp. = 40°C

Model	Number of poles	Coil ratings	Contact ratings	Number of test operations
G6D-1A-ASI	1	5 to 24 VDC	5 A, 250 VAC	6,000
			5 A, 30 VDC	

### CSA Certified (File No. LR31928)

Model	Number of poles	Coil ratings	Contact ratings	Number of test operations
G6D-1A-ASI	1	5 to 24 VDC	5 A, 250 VAC (General Use)	6,000
			5 A, 30 VDC (Resistive)	

### EN/TÜV Approval (Registration No. R50029064/EN61810-1)

Model	Number of poles	Coil ratings	Contact ratings	Number of test operations
G6D-1A-ASI	1	5, 12, 24 VDC	5 A, 250 VAC (cosφ=1.0)	70,000
			5 A, 30 VDC (0 ms)	

**Note:** 1. The rated values approved by each of the safety standards (e.g., UL, CSA, TUV) may be different from the performance characteristics individually defined in this catalog.

2. In the interest of product improvement, specifications are subject to change.

## Precautions

### ■ Spacing Between Relays

More than two relays can be closely mounted right side up as shown in the illustration below.

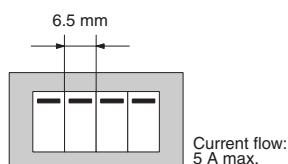

More than two relays can be closely mounted upside down as shown in the illustration below.

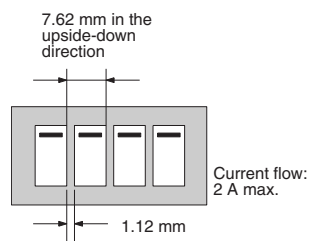

**Note:** The space between each relay required for heat radiation may vary with operating conditions.

### ■ Socket Mounting

When mounting the relay, insert it into the socket as vertically as possible so that the relay terminals contact securely with the contact pins on the socket.

The P6D-04P socket is flux-resistant. Do not wash the socket with water.

Remove the relay from the socket before soldering the socket to a PC board.

#### Mounting height

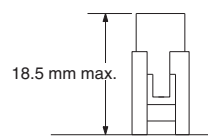

A large grid of 20 columns and 30 rows of small squares, used for taking notes or drawing diagrams. The grid is composed of thin, light gray lines forming a uniform pattern across the page.

All sales are subject to Omron Electronic Components LLC standard terms and conditions of sale, which can be found at [http://www.components.omron.com/components/web/webfiles.nsf/sales\\_terms.html](http://www.components.omron.com/components/web/webfiles.nsf/sales_terms.html)

**ALL DIMENSIONS SHOWN ARE IN MILLIMETERS.**  
To convert millimeters into inches, multiply by 0.03937. To convert grams into ounces, multiply by 0.03527.

---

**OMRON**<sup>®</sup>

**OMRON ELECTRONIC  
COMPONENTS LLC**

55 E. Commerce Drive, Suite B  
Schaumburg, IL 60173

**847-882-2288**

**OMRON ON-LINE**

Global - <http://www.omron.com>

USA - <http://www.components.omron.com>

Cat. No. X301-E-1b

09/11

Specifications subject to change without notice

Printed in USA