

PCB Relay G5LE

A Cubic, Single-pole 10-A Power Relay

- High Capacity (-E) versions
- Subminiature “sugar cube” relay with universal footprint.
- Conforms to EN 61810-1. UL recognized/ CSA certified.
- UL class-F coil insulation model available (UL class-B coil insulation for standard model).
- Withstands impulse of up to 4,500 V.
- 400-mW and 360-mW coil power types available.
- RoHS Compliant



Ordering Information

Enclosure ratings	Contact form/Style	Contact material		
		AgSnO ₂	AgSnIn	
		Standard	Standard	High Capacity
Flux protection	SPDT	G5LE-1 G5LE-1-CF	G5LE-1-ASI G5LE-1-ASI-CF	G5LE-1-E
	SPST-NO	G5LE-1A G5LE-1A-CF	G5LE-1A-ASI G5LE-1A-ASI-CF	G5LE-1A-E
Fully sealed	SPDT	G5LE-14 G5LE-14-CF	G5LE-14-ASI G5LE-14-ASI-CF	---
	SPST-NO	G5LE-1A4 G5LE-1A4-CF	G5LE-1A4-ASI G5LE-1A4-ASI-CF	---

Note: When ordering, add the rated coil voltage to the model number.

Example: G5LE-1 DC12
└───┬─── Rated coil voltage

Model Number Legend

G5LE - - - - - - - - - - - DC

1 2 3 4 5 6 7 8 9 10

1. Number of Poles

1: 1 pole

2. Contact Form

None: SPDT
 A: SPST-NO

3. Enclosure Ratings

None: Flux protection
 4: Fully sealed
 (Not applicable with -E versions)

4. Contact Material

None: AgSnO₂ (AgSnIn for -E versions)
 ASI: AgSnIn

5. Insulation System

None: Class B (Class F for -E versions)
 CF: Class F (UL and CSA only)

6. Classification

E: High capacity type

7. Coil Power Consumption/Coil Characteristic

None: Approx. 400 mW (Approx. 700mW for -G versions)
 36: Approx. 360 mW (Not applicable for -G versions)

8. Approved Standards

None: UL, CSA, and VDE

9. Packaging

None: Standard polystyrene tray
 SP: Anti-static tube packaging

10. Rated Coil Voltage

5, 9, 12, 24, 48 VDC

Specifications

■ Coil Ratings

400-mW Type

Rated voltage	5 VDC	9 VDC	12 VDC	24 VDC	48 VDC
Rated current	79.4 mA	45 mA	33.3 mA	16.7 mA	8.33 mA
Coil resistance	63 Ω	200 Ω	360 Ω	1,440 Ω	5,760 Ω
Must operate voltage	75% max. of rated voltage (max.)				
Must release voltage	10% min. of rated voltage (min.)				
Max. voltage	130% of rated voltage at 85°C, 170% of rated voltage at 23°C				
Power consumption	Approx. 400 mW				

Note: The rated current and coil resistance are measured at a coil temperature of 23°C with a tolerance of ±10%.

360-mW Type

Rated voltage	5 VDC	9 VDC	12 VDC	24 VDC	48 VDC
Rated current	72 mA	40 mA	30 mA	15 mA	7.5 mA
Coil resistance	70 Ω	225 Ω	400 Ω	1,600 Ω	6,400 Ω
Must operate voltage	75% max. of rated voltage (max.)				
Must release voltage	10% min. of rated voltage (min.)				
Max. voltage	130% of rated voltage at 85°C, 170% of rated voltage at 23°C				
Power consumption	Approx. 360 mW				

Note: The rated current and coil resistance are measured at a coil temperature of 23°C with a tolerance of ±10%.

■ Contact Ratings

	Standard	G5LE-E
Load	Resistive load (cosφ = 1)	
Rated load	10 A at 120 VAC; 8 A at 30 VDC 10A at 240VAC (12 and 24 VDC coil)	16A at 250VAC
Contact Material	AgSnO ₂ (AgSnIn optional)	AgSnIn
Rated carry current	10 A	16A
Max. switching voltage	250 VAC, 125 VDC (30 VDC when UL/CSA standard is applied)	250VAC
Max. switching current	AC: 10 A; DC: 8 A	AC: 16A
Max. switching power	1,200 VA, 240 W	4,000VA
Minimum Permissible Load (See note)	100 mA at 5 VDC	

Note: Reference value - P level: $\lambda_{60} = 0.1 \times 10^{-6}$ operations

■ Characteristics

Contact resistance	100 mΩ max.	
Operate time	10 ms max.	
Release time	5 ms max.	
Bounce Time	Operate: Approx. 0.6ms Release: Approx. 7.2ms	
Max. switching frequency	Mechanical:	18,000 operations/hr
	Electrical:	1,800 operations/hr at rated load
Insulation resistance	100 MΩ min. (at 500 VDC)	
Dielectric strength	2,000 VAC, 50/60 Hz for 1 min between coil and contacts 750 VAC, 50/60 Hz for 1 min between contacts of same polarity	
Impulse withstand voltage	4,500 V (1.2 x 50 μs) between coil and contacts	
Insulation Distance	Creepage (Typ)	3.3 mm
	Clearance (Typ)	2.7 mm
Tracking Resistance (CTI)	250 V	
Vibration resistance	Destruction:	10 to 55 to 10 Hz, 0.75-mm single amplitude (1.5-mm double amplitude)
	Malfunction:	10 to 55 to 10 Hz, 0.75-mm single amplitude (1.5-mm double amplitude)
Shock resistance	Destruction:	1,000 m/s ²
	Malfunction:	100 m/s ²
Endurance	Mechanical:	10,000,000 operations min. (at 18,000 operations/hr)
	Electrical:	100,000 operations min. (at 1,800 operations/hr) for standard type 36,000 operations min. (10A at 250VAC) 100,000 operations min. (at 1,800 operations/hr), 12A 250 VAC) - applicable for G5LE-1-E,NO contact only
Ambient temperature	Operating: -40°C to 85°C (with no icing)	
Ambient humidity	Operating: 5% to 85%	
Weight	Approx. 12 g	

■ Approved Standards

UL Recognized (File No. E41643)

CSA Certified (File No. LR34815)

Model	Coil rating	Contact rating
G5LE	3 to 48 VDC (Standard)	10 A, 250 VAC (general use), 6,000 cycles, 40°C (excluding -G type) 10 A, 125 VAC (general use), 100,000 cycles, 40°C (excluding -E, -G types) 8 A, 30 VDC (resistive load), 6,000 cycles, 40°C (excluding -E, -G types) 125 VA, 125 VAC, pilot duty, 100,000 cycles, 105°C (excluding -G type) NO: 13 A, 120 VAC, resistive, 100,000 cycles, 85°C (AgSnO ₂ & -E types, only) 1/2 hp, 125 VAC, 100,000 cycles, 40°C (excluding -G type) 1/3 hp, 125 VAC, 30,000 cycles, 70°C (AgSnO ₂ type only, excluding -E, -G types) 400W-T (3.3A), 120 VAC, tungsten, 100,000 cycles (AgSnO ₂ type only, excluding -E, -G types) TV-5, 120 VAC, 40°C (-ASI type only, excluding -E, -G types) 12 A, 250 VAC, general use, 100,000 cycles, 1s=on, 1s=off, 105°C (-E type only) TV-8, 120 VAC, 25,000 cycles, 40°C (-E type only) 10 A, 35 VDC, resistive, 100,000 cycles, 1s=on, 1s=off, 40°C (-G type only) NC: 12 A, 250 VAC, general use, 30,000 cycles, 1s=on, 9s=off, 40°C (-E type only) 10 A, 35 VDC, resistive, 50,000 cycles, 5s=on, 5s=off, 40°C (-G type only) 1/8 hp, 120 VAC, 50,000 cycles, 40°C (AgSnO ₂ type only, excluding -E, -G types)
	5 to 24 VDC (-E versions)	

EN 61810-1, EN 60255, IEC (VDE TUV Reg No. R9151267, VDE Reg No. 6850UG)

Model	Coil rating	Contact rating
G5LE	Approx. 400 mW 3, 5, 6, 9, 12, 24, 48 VDC Approx. 360 mW 5, 6, 12, 24, 48 VDC	10A, 250VAC (resistive load, 50,000 cycles at 85°C) 5A, 30VDC 2.5 A, 250 VAC (cosφ = 0.4)

Engineering Data

For standard type

Max. Switching Capacity

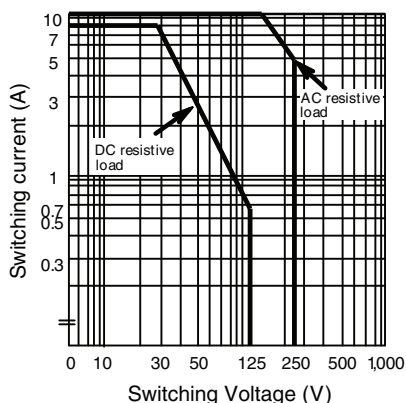

Life Expectancy

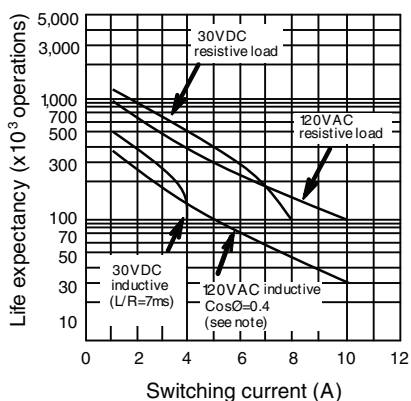

Note: Same curve as for 250-VAC resistive load

Ambient Temp. Vs. Max. Voltage

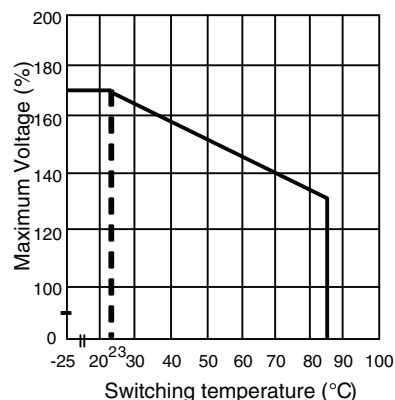

Note: The maximum coil voltage refers to the maximum value in a varying range of operating power voltage, not a continuous voltage.

For suffix -E

Max. Switching Capacity

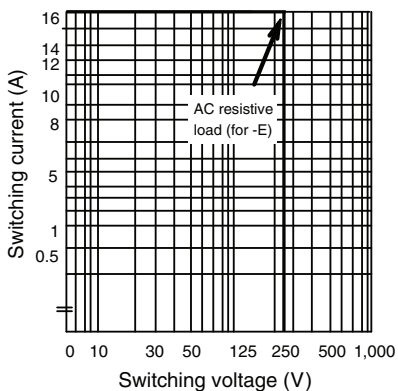

Life Expectancy

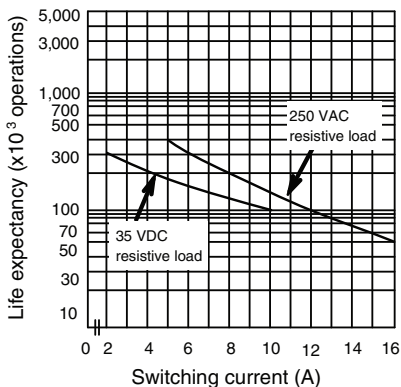

Ambient Temp. Vs. Max. Voltage

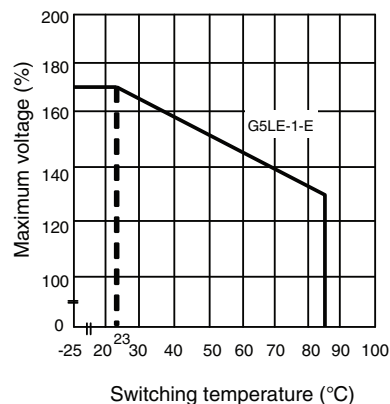

Note: The maximum coil voltage refers to the maximum value in a varying range of operating power voltage, not a continuous voltage.

Dimensions

- Note: 1. All units are in millimeters unless otherwise indicated.
 2. Orientation marks are indicated as follows:

G5LE-1 G5LE-1A

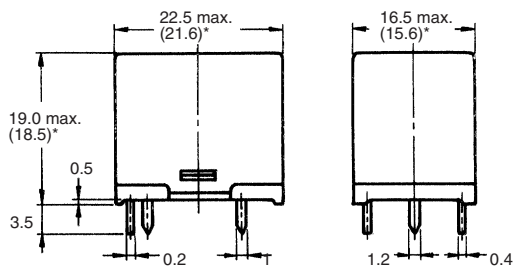
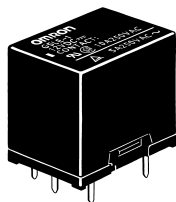

*Average value

G5LE-14 G5LE-1A4

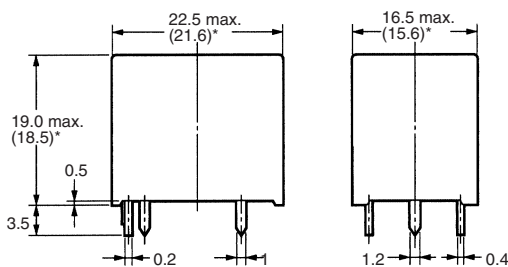
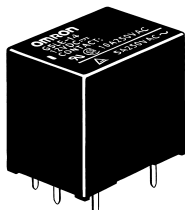

*Average value

Terminal Arrangement/Internal Connections (Bottom View)

SPDT

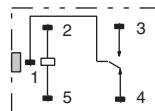

Mounting Holes (Bottom View)

Tolerance: ± 0.1 mm unless specified

SPDT

Five, $1.3^{+0.2}_0$ dia. holes

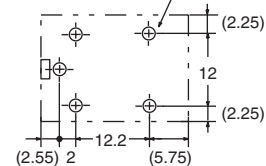

Terminal Arrangement/Internal Connections (Bottom View)

SPST-NO

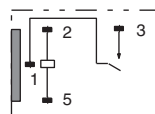

Mounting Holes (Bottom View)

Tolerance: ± 0.1 mm unless specified

SPST-NO

Four, $1.3^{+0.2}_0$ dia. holes

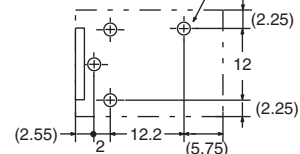

All sales are subject to Omron Electronic Components LLC standard terms and conditions of sale, which can be found at http://www.components.omron.com/components/web/webfiles.nsf/sales_terms.html

ALL DIMENSIONS SHOWN ARE IN MILLIMETERS.
To convert millimeters into inches, multiply by 0.03937. To convert grams into ounces, multiply by 0.03527.

OMRON[®]

**OMRON ELECTRONIC
COMPONENTS LLC**

55 E. Commerce Drive, Suite B
Schaumburg, IL 60173

847-882-2288

OMRON ON-LINE

Global - <http://www.omron.com>

USA - <http://www.components.omron.com>

Cat. No. X301-E-1d

08/13

Specifications subject to change without notice

Printed in USA