

Cylindrical photoelectric sensors in M18 plastic or brass housings

E3F2

- Complete sensor portfolio in plastic and metal housing
- IP67, IP69K for highest water resistance
- High immunity against electro-magnetic noise and ambient light
- Special beam models
- High power LED to compensate for dirt and misalignment



Performance and portfolio variety

Sensing method	Shape	Plastic	Metal ¹	90° Optics	AC power supply ²
Through-beam		7 m	7 m	-	3 m
Retro-reflective		4 m	4 m	2 m	1 m
Diffuse-reflective		1 m	1 m	0.3 m	0.3 m
Diffuse-reflective (background suppression)		0.1 m	0.1 m		

¹SUS types see separate datasheet









²AC-types see separate datasheet

L-on / D-on selectable by wiring M12 connector or pre-wired.

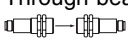
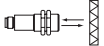

Selection Guide

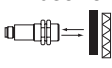
Housing Material: Plastic

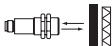
Sensing method	Sensing distance	Connection method				Order code	
					 *1	PNP output	NPN output
Through-beam 	7 m	-	-	2 m	-	E3F2-7B4 2M	E3F2-7C4 2M
		-	■	-	-	E3F2-7B4-P1	E3F2-7C4-P1
Retro-reflective with M.S.R.*2 	0.1 to 4 m (adjustable)*3	-	-	2 m	-	E3F2-R4B4-E 2M	E3F2-R4C4-E 2M
		-	■	-	-	E3F2-R4B4-P1-E	E3F2-R4C4-P1-E
Retro-reflective with M.S.R.*2 	0.1 to 2 m*4	-	-	2 m	-	E3F2-R2RB41-E 2M	E3F2-R2RC41-E 2M
		-	■	-	-	E3F2-R2RB41-P1-E	E3F2-R2RC41-P1-E
Diffuse-reflective 	0.1 m (fixed, wide-beam)	-	-	2 m	-	E3F2-DS10B4-N 2M	E3F2-DS10C4-N 2M
		-	■	-	-	E3F2-DS10B4-P1	E3F2-DS10C4-P1
	0.3 m (adjustable)	-	-	2 m	-	E3F2-DS30B4 2M	E3F2-DS30C4 2M
		-	■	-	-	E3F2-DS30B4-P1	E3F2-DS30C4-P1
	1 m (adjustable)	-	-	2 m	-	E3F2-D1B4 2M	E3F2-D1C4 2M
		-	■	-	-	E3F2-D1B4-P1	E3F2-D1C4-P1
Diffuse-reflective 	0.3 m (adjustable)	-	-	2 m	-	E3F2-DS30B41 2M	E3F2-DS30C41 2M
		-	■	-	-	E3F2-DS30B41-P1	E3F2-DS30C41-P1
Diffuse reflective (background suppression) 	0.1 m (fixed)	-	-	2 m	-	E3F2-LS10B4 2M	E3F2-LS10C4 2M
		-	■	-	-	E3F2-LS10B4-P1	E3F2-LS10C4-P1

*1. Pre-wired connectors are available on request. Please contact your OMRON representative.









*2. Order reflector separately. Models with reflector included are also available. Please contact your OMRON representative.



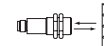

*3. Measured with reflector E39-R1S

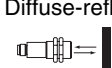
*4. Measured with reflector E39-R1

Note: Standard cable length is 2 m. Models provided with a 5 m long cable are available. When ordering, specify the cable length by adapting the length of the cable (e.g. E3F2-R4B4-E 5M). For other cable length please contact your OMRON sales representative.

Housing material: Metal (Nickel plated brass)

Sensing method	Sensing distance	Connection method				Order code	
					 *1	PNP output	NPN output
Through-beam 	7 m	-	-	2 m	-	E3F2-7B4-M 2M	E3F2-7C4-M 2M
		-	■	-	-	E3F2-7B4-M1-M	E3F2-7C4-M1-M
Retro-reflective with M.S.R.*2 	0.1 to 4 m (adjustable)*3	-	-	2 m	-	E3F2-R4B4-M-E 2M	E3F2-R4C4-M-E 2M
		-	■	-	-	E3F2-R4B4-M1-M-E	E3F2-R4C4-M1-M-E
Retro-reflective with M.S.R.*2 	0.1 to 2 m*4	-	-	2 m	-	E3F2-R2RB41-M-E 2M	E3F2-R2RC41-M-E 2M
		-	■	-	-	E3F2-R2RB41-M1-M-E	E3F2-R2RC41-M1-M-E
Diffuse-reflective 	0.1 m (fixed, wide-beam)	-	-	2 m	-	E3F2-DS10B4-M 2M	E3F2-DS10C4-M 2M
		-	■	-	-	E3F2-DS10B4-M1-M	E3F2-DS10C4-M1-M
	0.3 m (adjustable)	-	-	2 m	-	E3F2-DS30B4-M 2M	E3F2-DS30C4-M 2M
		-	■	-	-	E3F2-DS30B4-M1-M	E3F2-DS30C4-M1-M
	1 m (adjustable)	-	-	2 m	-	E3F2-D1B4-M 2M	E3F2-D1C4-M 2M
		-	■	-	-	E3F2-D1B4-M1-M	E3F2-D1C4-M1-M
Diffuse-reflective 	0.3 m (adjustable)	-	-	2 m	-	E3F2-DS30B41-M 2M	E3F2-DS30C41-M 2M
		-	■	-	-	E3F2-DS30B41-M1-M	E3F2-DS30C41-M1-M

Sensing method	Sensing distance	Connection method				Order code	
					 *1	PNP output	NPN output
Diffuse-reflective (background suppression) 	0.1 m (fixed)	-	-	2 m	-	E3F2-LS10B4-M 2M	E3F2-LS10C4-M 2M
		-	■	-	-	E3F2-LS10B4-M1-M	E3F2-LS10C4-M1-M

- *1. Pre-wired connectors are available on request. Please contact your OMRON representative.
- *2. Order reflector separately. Models with reflector E39-R1S included are available. Please contact your OMRON representative.
- *3. with reflector E39-R1S
- *4. with reflector E39-R1

Note: Standard cable length is 2 m. Models provided with a 5 m long cable are available. When ordering, specify the cable length by adapting the length of the cable (e.g. E3F2-R4B4-E 5M). For other cable length please contact your OMRON sales representative.





Accessories (Order Separately)

Name	Sensing distance (typical) ^{*1}	Remark	Order code
Reflectors	3 m [100 mm] (axial types) 2 m [100 mm] (radial types)	60 x 40 mm	E39-R1
	4 m [100 mm] (axial types) 2 m [100 mm] (radial types)	60 x 40 mm	E39-R1S
	5 m [100 mm] (axial types) 2.5 m [100 mm] (radial types)	∅ 84 mm	E39-R7
	6 m [100 mm] (axial types) 3 m [100 mm] (radial types)	100 x 100 mm	E39-R8
	5 m [100 mm] (axial types) 2.5 m [100 mm] (radial types)	80 x 80 mm	E39-R40
Tape Reflectors	0.7 m [150 mm] (axial types)	35 x 10 mm	E39-RS1
	1.1 m [150 mm] (axial types)	35 x 40 mm	E39-RS2
	1.4 m [150 mm] (axial types)	80 x 70 mm	E39-RS3
Lens Cap			E39-F31
Mounting Bracket		screw mount	Y92E-B18

*1. Values in parentheses indicate the minimum required distance between the sensor and reflector.

For detailed information about Accessories, refer to the main chapter "Accessories" at the end of the document.

Sensor I/O Connectors

Cord	Shape	Cable type	Order code
Standard	Straight 	2 m	Four-wire type XS2F-D421-D80-A XS2F-D421-G80-A XS2F-D422-D80-A XS2F-D422-G80-A
		5 m	
	L-shaped 	2 m	
		5 m	
Vibration-proof robot cable	Straight 	2 m	XS2F-D421-D80-R XS2F-D421-G80-R XS2F-D422-D80-R XS2F-D422-G80-R
		5 m	
	L-shaped 	2 m	
		5 m	

Specifications

Ratings

Item	E3F2-7□	E3F2-R4□-□	E3F2-DS10□	E3F2-DS30□	E3F2-D1□4-□	E3F2-LS10□4-□
Sensing method	Through-beam	Retro-reflective with M.S.R.	Diffuse-reflective			
			Wide beam	Potentiometer adjustment		Background suppression
Power supply voltage	10 to 30 VDC					
Current consumption	50 mA max.	30 mA max.	25 mA max.	30 mA max.		
Sensing distance	7 m	0.1 to 4 m (with E39-R1S)	0.1 m (5 x 5 cm white mat paper)	0.3 m (10 x 10 cm white mat paper)	1 m (30 x 30 cm white mat paper)	0.1 m (10 x 10 cm white mat paper)
Standard object	Opaque: 11 mm dia. min.	Opaque: 56 mm dia. min.	-			
Directional angle	3° to 20°		-			
Differential travel (hysteresis)	-		20% max.			5% max
Black/white error	-					3%
Response time	Operation and Reset: 2.5 ms max.	1 ms max	2.5 ms max.		1 ms max.	
Control output	Transistor (open collector), load current: 100 mA max. (residual voltage: 2 V max.)					
Power reset time	50 ms	100 ms max.	50 ms		100 ms	
Ambient illumination	Incandescent lamp:3000 lx max. / Sunlight:10000 lx max.					
Ambient temperature	Operating: -25 to 55 °C / Storage: -30 to 70 °C (with no icing or condensation)					
Ambient humidity	Operating: 35% to 85% / Storage: 35% to 95% (with no condensation)					
Insulation resistance	20 MΩ min. at 500 V DC between energized parts and case					
Dielectric strength	1000 VAC max., 50 / 60 Hz for 1 min between energized parts and case					
Vibration resistance	10 to 55 Hz, 1.5 mm double amplitude for 2 hrs each direction (X, Y, Z)					
Shock resistance	Destruction: 500 m/s ² each direction (X, Y, Z)					
Degree of protection*1	IEC 60529 IP67, IP69K after DIN 40050-9					
Light source (wave length)	Infrared LED (950 nm)	Red LED (660 nm)	Infrared LED (880 nm)			Red LED (660 nm)
Indicators	Light incident / power indicator for light source (red)	Light incident (red) / stability (green)	Light incident / power indicator for light source (red)		Light incident (red) / stability (green)	Output indicator (orange) / stability (green)
Sensitivity adjustment	Fixed	Adjustable	Fixed	Adjustable		Fixed
Connection method	2 m, 5 m pre-wired cable (PVC, dia. 4 mm (18 / 0.12) ^{*2}) or M12-connector					
Operation mode	Light-ON or Dark-ON selectable by wiring					
Weight (approx.)						
Plastic case	pre-wired (2 m)	120 g	60 g			
	connector	40 g	20 g			
Metal case	pre-wired (2 m)	180 g	90 g			
	connector	120 g	50 g			
Circuit protection	Output short-circuit and power supply reverse polarity					
Housing materials ^{*3}	Case: ABS (plastic models) or nickel brass (metal models); lens: PMMA					

*1. The IP69k test according to DIN 40 050 part 9 is intended to simulate high pressure/steam cleaning. During the test 14-16 l/min water at 80°C is sprayed onto the sensor from different angles with 8000-10000 kPa. The sensor may not suffer any damaging effects from high pressure water in appearance and functionality.

*2. For other cable materials (e.g. PUR) contact your OMRON sales representative.

*3. For stainless steel types refer to separate datasheet E3F2 SUS

Engineering Data (Typical)

Operating Range (typical)

Through-beam Models (axial)

E3F2-7□4-□

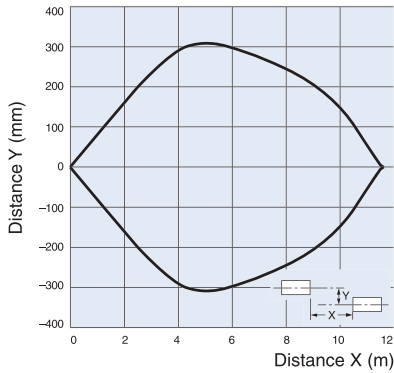

Retro-reflective Models (axial)

E3F2-R4□4-□ (polarizing)

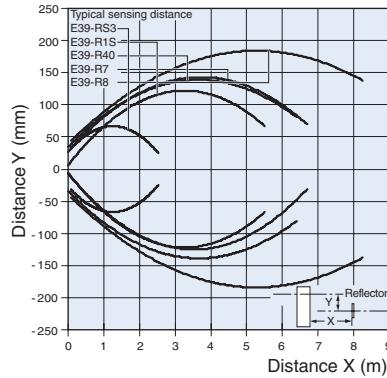

Retro-reflective Models (radial)

E3F2-R2R□41-□ (polarizing) and reflectors

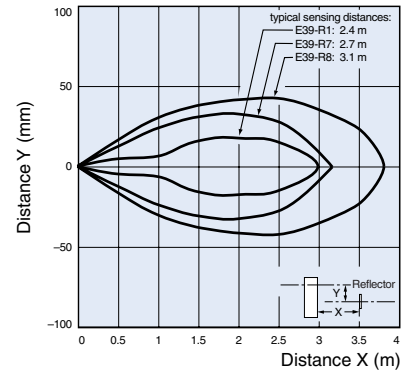

Diffuse-reflective Models (axial)

E3F2-DS10□4-□ (wide-beam type)

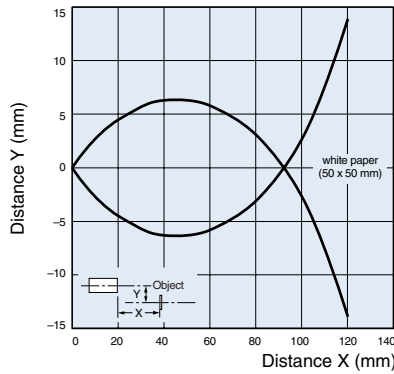

Diffuse-reflective Models (axial)

E3F2-DS30□4-□

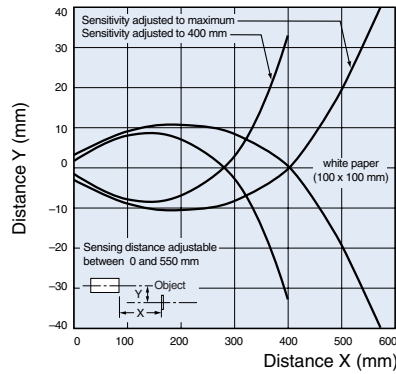

Diffuse-reflective Models (radial)

E3F2-DS30□41-□

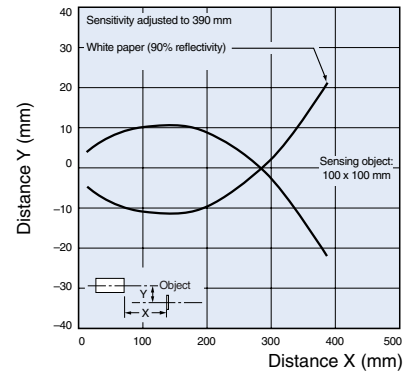

Diffuse-reflective Models (axial)

E3F2-D1□4-□

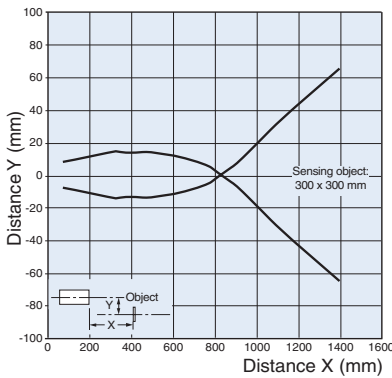

Excess Gain Ratio vs. Distance (typical)

Through-beam Models (axial)

E3F2-7□4-□

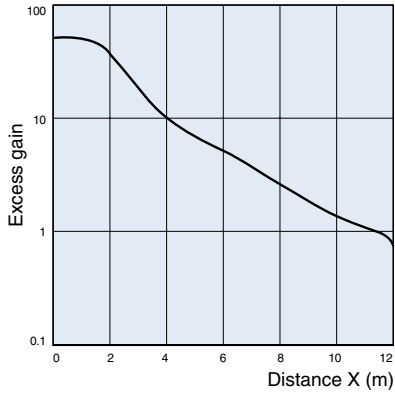

Retro-reflective Models (axial)

E3F2-R4□4-□

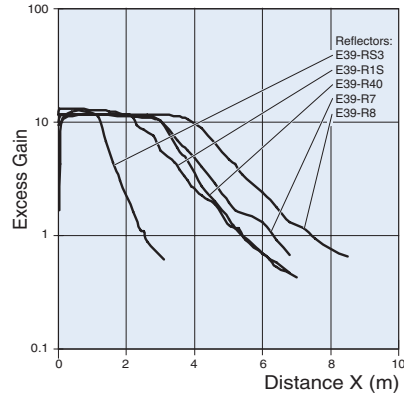

Retro-reflective Models (radial)

E3F2-R2R□41-□ (polarizing) and reflectors

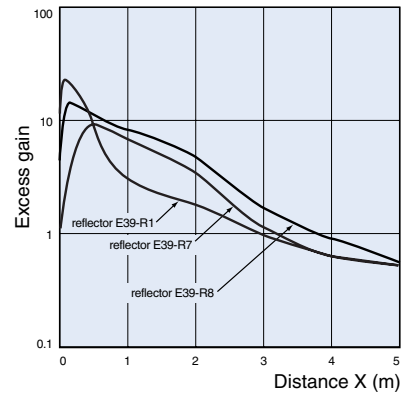

Diffuse-reflective Models (axial)

E3F2-DS10□4-□ (wide-beam type)

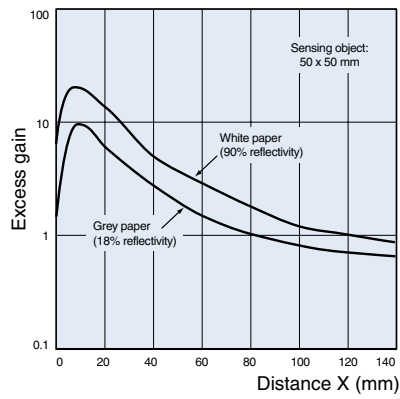

Diffuse-effective Models (axial)

E3F2-DS30□4-□

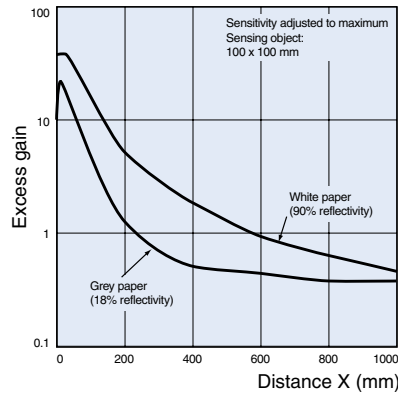

Diffuse-reflective Models (radial)

E3F2-DS30□41-□

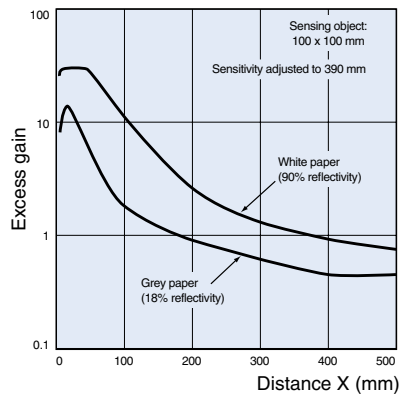

Diffuse-reflective Models (axial)

E3F2-D1□4-□

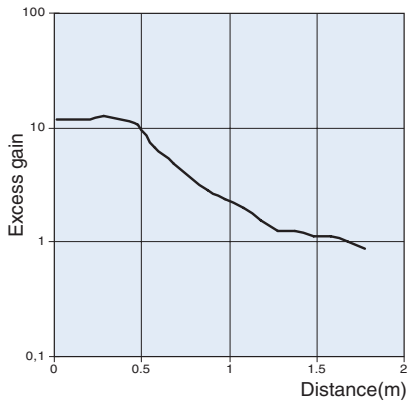

Light spot vs sensing distance

Background suppression Models
E3F2-LS□

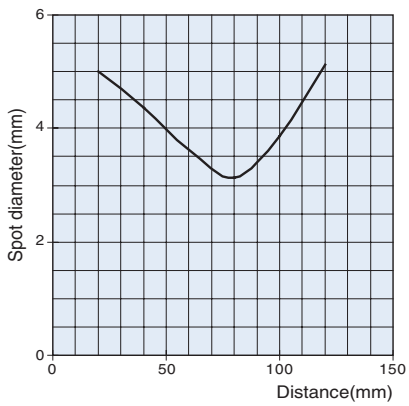

Incline (horizontal)

Background suppression Models
E3F2-LS□

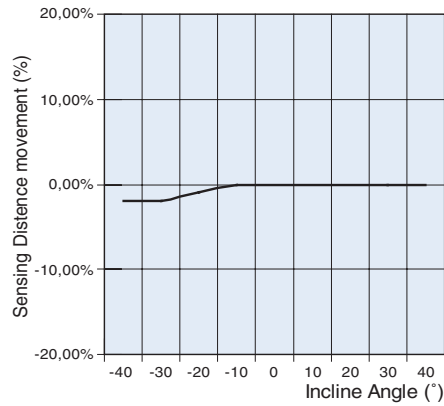

Incline (vertical)

Background suppression Models
E3F2-LS□

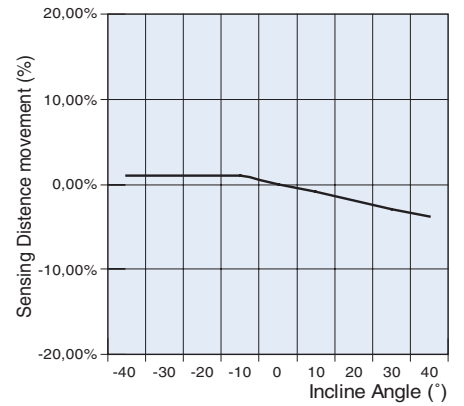

Object material vs sensing distance

Background suppression Models
E3F2-LS□

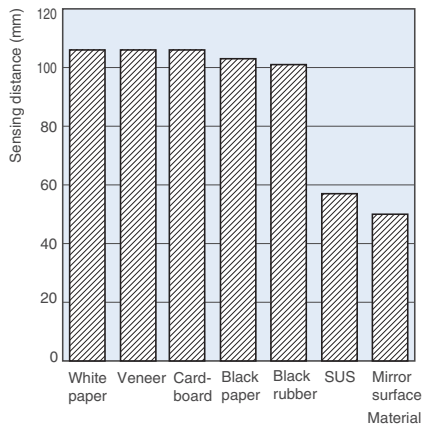

Operation

Output Circuits

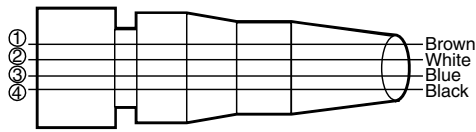

XS2F-D42□-D80□
XS2F-G42□-G80□

Structure of Sensor I/O Connector

Classification	Wire color	Connector pin No.	Use
DC	Brown	①	Power supply (+V)
	White	②	Mode selection Lon/Don
	Blue	③	Power supply (0 V)
	Black	④	Output

PNP Output

Model	Output transistor status	Timing chart	Connection method	Output circuit
E3F2-□B4-□ (except for E3F2-LS10B4-□)	—	—	—	<p>Through-beam emitter</p> <p>Connector Pin Arrangement</p>
	ON when light is incident. (Light-ON)	<p>Incident Interrupted</p>	Connect the pink (Pin ②) and brown (Pin ①) cords or open the pink cord (Pin ②).	<p>Connector Pin Arrangement</p> <p>* Only on models E3F2-R4B4-□ and E3F2-D1B4-□</p>
	ON when light is interrupted. (Dark-ON)	<p>Incident Interrupted</p>	Connect the pink (Pin ②) and blue (Pin ③) cords.	<p>Connector Pin Arrangement</p> <p>* Only on models E3F2-R4B4-□ and E3F2-D1B4-□</p>
E3F2-LS10B4-□	ON when light is incident. (Light-ON)	<p>Incident Interrupted</p>	Connect the pink (Pin ②) and brown (Pin ①) cords or open the pink cord (Pin ②).	<p>Connector Pin Arrangement</p>
	ON when light is interrupted. (Dark-ON)	<p>Incident Interrupted</p>	Connect the pink (Pin ②) and blue (Pin ③) cords.	<p>Connector Pin Arrangement</p>

Note: Terminal numbers for connector type.

NPN Output

Model	Output transistor status	Timing chart	Connection method	Output circuit
E3F2-□C4-□ (except for E3F2-LS10C4-□)	—		—	<p>Through-beam emitter</p> <p>Connector Pin Arrangement</p>
	ON when light is incident. (Light-ON)	<p>Incident Interrupted</p> <p>Output indicator (red) ON OFF</p> <p>Output transistor ON OFF</p> <p>Load (relay) Operate Release</p>	Connect the pink (Pin ②) and brown (Pin ①) cords or open the pink cord (Pin ②).	<p>Connector Pin Arrangement</p> <p>* Only on models E3F2-R4C4-□ and E3F2-D1C4-□</p>
	ON when light is interrupted. (Dark-ON)	<p>Incident Interrupted</p> <p>Output indicator (red) ON OFF</p> <p>Output transistor ON OFF</p> <p>Load (relay) Operate Release</p>	Connect the pink (Pin ②) and blue (Pin ③) cords.	<p>Connector Pin Arrangement</p> <p>* Only on models E3F2-R4C4-□ and E3F2-D1C4-□</p>
E3F2-LS10C4-□	ON when light is incident. (Light-ON)	<p>Incident Interrupted</p> <p>Output indicator (red) ON OFF</p> <p>Output transistor ON OFF</p> <p>Load (relay) Operate Release</p>	Connect the pink (Pin ②) and brown (Pin ①) cords or open the pink cord (Pin ②).	<p>Connector Pin Arrangement</p>
	ON when light is interrupted. (Dark-ON)	<p>Incident Interrupted</p> <p>Output indicator (orange) ON OFF</p> <p>Output transistor ON OFF</p> <p>Load (relay) Operate Release</p>	Connect the pink (Pin ②) and blue (Pin ③) cords.	<p>Connector Pin Arrangement</p>

Note: Terminal numbers for connector type.

Dimensions Note: All units are in millimeters unless otherwise indicated

Plastic models, axial type

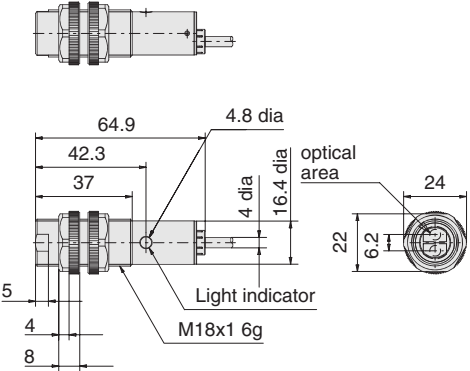
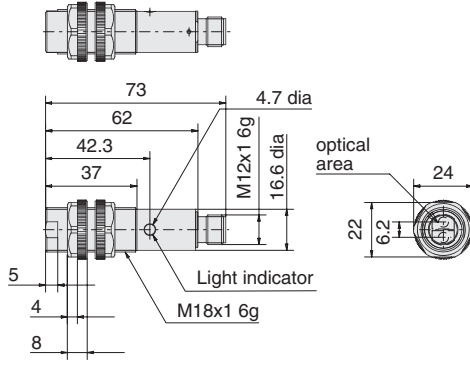
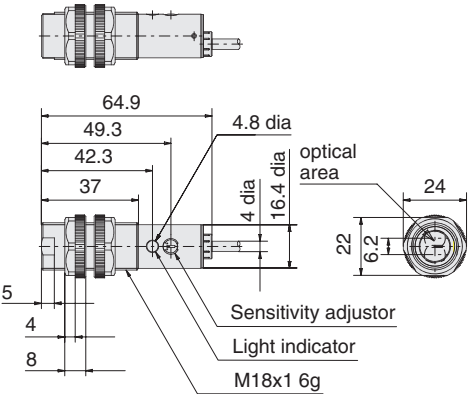
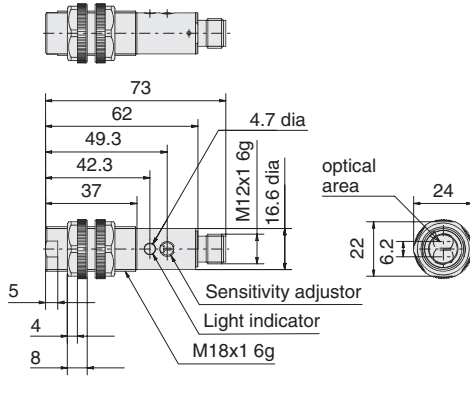
Cable type	Connector type
<p>Without potentiometer</p> <p>E3F2-7□ E3F2-DS10□4-N E3F2-LS10□4</p> 	<p>E3F2-7□-P1 E3F2-DS10□4-P1 E3F2-LS10□4-P1</p> 
<p>With potentiometer</p> <p>E3F2-DS30□4 E3F2-D1□4 E3F2-R4□</p> 	<p>E3F2-DS30□4-P1 E3F2-D1□4-P1 E3F2-R4□-P1</p> 

Plastic models, radial type

Cable type	Connector type
Without potentiometer	
<p>E3F2-R2R□41</p>	<p>E3F2-R2R□41-P1</p>
With potentiometer	
<p>E3F2-DS30□41</p>	<p>E3F2-DS30□41-P1</p>

Metal Models, axial type

Cable type	Connector type
Without potentiometer	
<p>E3F2-7□-M E3F2-DS10□4-M E3F2-LS10□4-M</p>	<p>E3F2-7□-M1-M E3F2-DS10□4-M1-M E3F2-LS10□4-M1-M</p>
With potentiometer	
<p>E3F2-DS30□4-M E3F2-R4□4-M E3F2-D1□4-M</p>	<p>E3F2-DS30□4-M1-M E3F2-R4□4-M1-M E3F2-D1□4-M1-M</p>

Metal Models, radial type

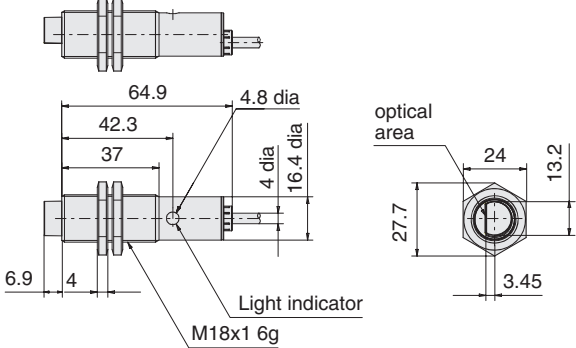
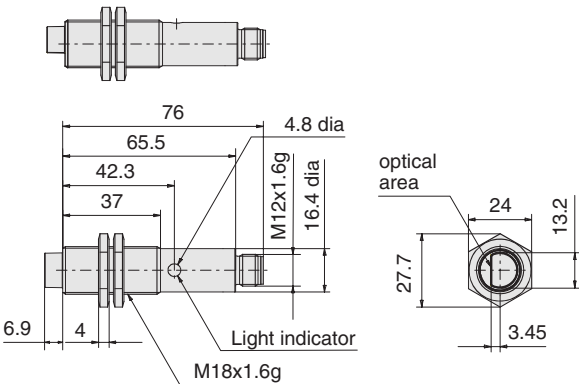
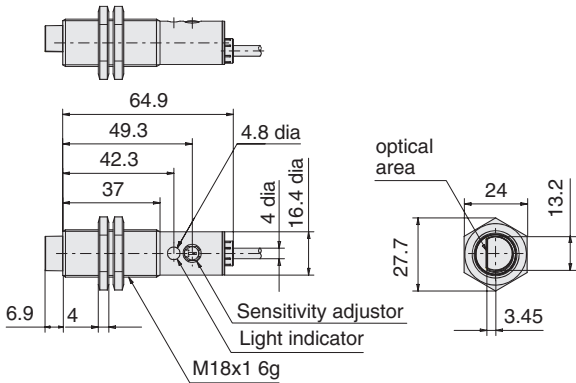
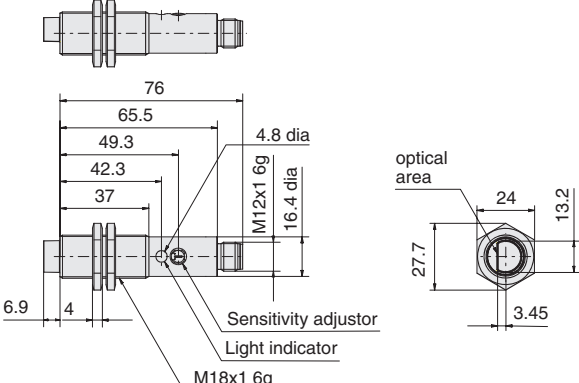
Cable type	Connector type
<p>Without potentiometer</p> <p>E3F2-R2R□41-M</p> 	<p>E3F2-R2R□41-M1</p> 
<p>With potentiometer</p> <p>E3F2-DS30□41-M</p> 	<p>E3F2-DS30□41-M1-M</p> 

Accessories (Order Separately)

Reflector

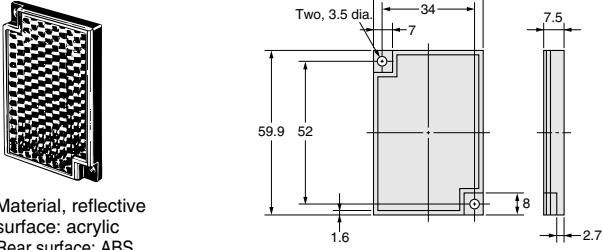
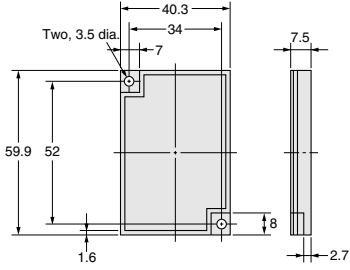
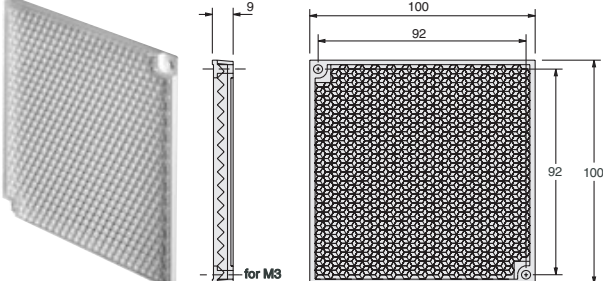
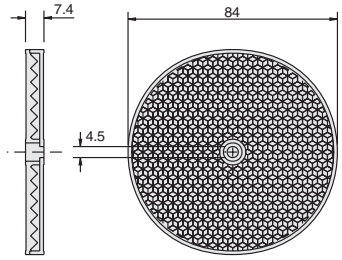
<p>E39-R1 E39-R1S</p>  <p>Material, reflective surface: acrylic Rear surface: ABS</p>	<p>E39-R7</p> 
<p>E39-R8</p> 	<p>E39-R40</p> 

Tape reflectors

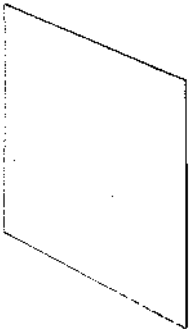
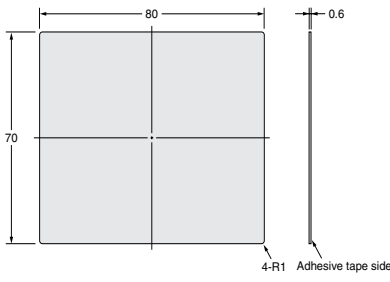
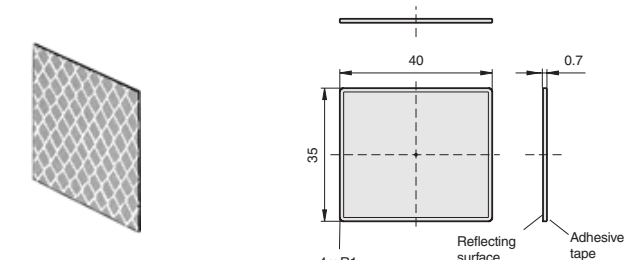
<p>E39-RS3</p> 	<p>E39-RS1</p>  <p>E39-RS2</p> 
---	---

Installation

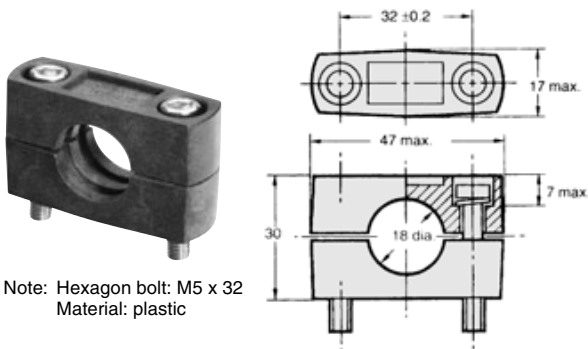
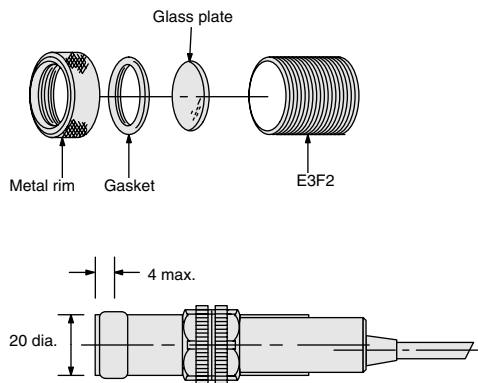
<p>Mounting Bracket Y92E-B18</p>  <p>Note: Hexagon bolt: M5 x 32 Material: plastic</p>	<p>Lens Cap E39-F31</p> 
---	--

Safety precautions

Warning

This product is not designed or rated for directly or indirectly ensuring safety of persons. Do not use it for such a purpose.



Caution

Do not use the product with voltage in excess of the rated voltage. Excess voltage may result in malfunction or fire.



Never use the product with an AC power supply. Otherwise, explosion may result.



When cleaning the product, do not apply a high-pressure spray of water to one part of the product. Otherwise, parts may become damaged and the degree of protection may be degraded.



High-temperature environments may result in burn injury.



Precautions for Safe Use

The following precautions must be observed to ensure safe operation of the Sensor.

Operating Environment

Do not use the Sensor in an environment where explosive or flammable gas is present.

Connecting Connectors

Be sure to hold the connector cover when inserting or removing the connector. Be sure to tighten the connector lock by hand; do not use pliers or other tools. If the tightening is insufficient, the degree of protection will not be maintained and the Sensor may become loose due to vibration. The appropriate tightening torque is 0.39 to 0.49 N·m for M12 connectors.

Load

Do not use a load that exceeds the rated load.

Rotation Torque for Sensitivity Adjustment

Adjust with a torque of 0.05 N·m or less.

Environments with Cleaners and Disinfectants (e.g., Food Processing Lines)

Do not use the Sensor in environments subject to cleaners and disinfectants. They may reduce the degree of protection.

Modifications

Do not attempt to disassemble, repair, or modify the Sensor.

Outdoor Use

Do not use the Sensor in locations subject to direct sunlight.

Cleaning

Do not use thinner, alcohol, or other organic solvents. Otherwise, the optical properties and degree of protection may be degraded.

Surface Temperature

Burn injury may occur. The Sensor surface temperature rises depending on application conditions, such as the surrounding temperature and the power supply voltage. Use caution when operating or washing the Sensor.

Precautions for Correct Use

Do not use the Sensor in any atmosphere or environment that exceeds the ratings.

Do not install the Sensor in the following locations.

- (1) Locations subject to direct sunlight
- (2) Locations subject to condensation due to high humidity
- (3) Locations subject to corrosive gas
- (4) Locations where the Sensor may receive direct vibration or shock

Connecting and Mounting

- (1) The maximum power supply voltage is 30 VDC. Before turning the power ON, make sure that the power supply voltage does not exceed the maximum voltage.
- (2) Laying Sensor wiring in the same conduit or duct as high-voltage wires or power lines may result in malfunction or damage due to induction. As a general rule, wire the Sensor in a separate conduit or use shielded cable.
- (3) Use an extension cable with a minimum thickness of 0.3 mm² and less than 100 m long.
- (4) Do not pull on the cable with excessive force.
- (5) Pounding the Photoelectric Sensor with a hammer or other tool during mounting will impair water resistance.
- (6) Mount the Sensor using a bracket (sold separately). Do not exceed a torque of 2.0 Nm when tightening mounting nuts for plastic models or 20.0 Nm when tightening mounting nuts for metal models
- (7) Be sure to turn OFF the power supply before inserting or removing the connector.

Cleaning

Never use thinner or other solvents. Otherwise, the Sensor surface may be dissolved.

Power Supply

If a commercial switching regulator is used, ground the FG (frame ground) terminal.

Power Supply Reset Time

The Sensor will be able to detect objects 100 ms after the power supply is turned ON. Start using the Sensor 100 ms or more after turning ON the power supply. If the load and the Sensor are connected to separate power supplies, be sure to turn ON the Sensor first.

Turning OFF the Power Supply

Output pulses may be generated even when the power supply is OFF. Therefore, it is recommended to first turn OFF the power supply for the load or the load line.

Load Short-circuit Protection

This Sensor is equipped with load short-circuit protection, but be sure to not short circuit the load. Be sure to not use an output current flow that exceeds the rated current. If a load short circuit occurs, the output will turn OFF, so check the wiring before turning ON the power supply again. The short-circuit protection circuit will be reset.

Water Resistance

Do not use the Sensor in water, rainfall, or outdoors.

WARRANTY

OMRON's exclusive warranty is that the products are free from defects in materials and workmanship for a period of one year (or other period if specified) from date of sale by OMRON.

OMRON MAKES NO WARRANTY OR REPRESENTATION, EXPRESS OR IMPLIED, REGARDING NON-INFRINGEMENT, MERCHANTABILITY, OR FITNESS FOR PARTICULAR PURPOSE OF THE PRODUCTS. ANY BUYER OR USER ACKNOWLEDGES THAT THE BUYER OR USER ALONE HAS DETERMINED THAT THE PRODUCTS WILL SUITABLY MEET THE REQUIREMENTS OF THEIR INTENDED USE. OMRON DISCLAIMS ALL OTHER WARRANTIES, EXPRESS OR IMPLIED.

LIMITATIONS OF LIABILITY

OMRON SHALL NOT BE RESPONSIBLE FOR SPECIAL, INDIRECT, OR CONSEQUENTIAL DAMAGES, LOSS OF PROFITS OR COMMERCIAL LOSS IN ANY WAY CONNECTED WITH THE PRODUCTS, WHETHER SUCH CLAIM IS BASED ON CONTRACT, WARRANTY, NEGLIGENCE, OR STRICT LIABILITY.

In no event shall responsibility of OMRON for any act exceed the individual price of the product on which liability is asserted.

IN NO EVENT SHALL OMRON BE RESPONSIBLE FOR WARRANTY, REPAIR, OR OTHER CLAIMS REGARDING THE PRODUCTS UNLESS OMRON'S ANALYSIS CONFIRMS THAT THE PRODUCTS WERE PROPERLY HANDLED, STORED, INSTALLED, AND MAINTAINED AND NOT SUBJECT TO CONTAMINATION, ABUSE, MISUSE, OR INAPPROPRIATE MODIFICATION OR REPAIR.

SUITABILITY FOR USE

THE PRODUCTS CONTAINED IN THIS DOCUMENT ARE NOT SAFETY RATED. THEY ARE NOT DESIGNED OR RATED FOR ENSURING SAFETY OF PERSONS, AND SHOULD NOT BE RELIED UPON AS A SAFETY COMPONENT OR PROTECTIVE DEVICE FOR SUCH PURPOSES. Please refer to separate catalogs for OMRON's safety rated products.

OMRON shall not be responsible for conformity with any standards, codes, or regulations that apply to the combination of products in the customer's application or use of the product.

At the customer's request, OMRON will provide applicable third party certification documents identifying ratings and limitations of use that apply to the products. This information by itself is not sufficient for a complete determination of the suitability of the products in combination with the end product, machine, system, or other application or use.

The following are some examples of applications for which particular attention must be given. This is not intended to be an exhaustive list of all possible uses of the products, nor is it intended to imply that the uses listed may be suitable for the products:

- Outdoor use, uses involving potential chemical contamination or electrical interference, or conditions or uses not described in this document.
- Nuclear energy control systems, combustion systems, railroad systems, aviation systems, medical equipment, amusement machines, vehicles, safety equipment, and installations subject to separate industry or government regulations.
- Systems, machines, and equipment that could present a risk to life or property.

Please know and observe all prohibitions of use applicable to the products.

NEVER USE THE PRODUCTS FOR AN APPLICATION INVOLVING SERIOUS RISK TO LIFE OR PROPERTY WITHOUT ENSURING THAT THE SYSTEM AS A WHOLE HAS BEEN DESIGNED TO ADDRESS THE RISKS, AND THAT THE OMRON PRODUCT IS PROPERLY RATED AND INSTALLED FOR THE INTENDED USE WITHIN THE OVERALL EQUIPMENT OR SYSTEM.

PERFORMANCE DATA

Performance data given in this document is provided as a guide for the user in determining suitability and does not constitute a warranty. It may represent the result of OMRON's test conditions, and the users must correlate it to actual application requirements. Actual performance is subject to the OMRON Warranty and Limitations of Liability.

CHANGE IN SPECIFICATIONS

Product specifications and accessories may be changed at any time based on improvements and other reasons.

It is our practice to change model numbers when published ratings or features are changed, or when significant construction changes are made. However, some specifications of the product may be changed without any notice. When in doubt, special model numbers may be assigned to fix or establish key specifications for your application on your request. Please consult with your OMRON representative at any time to confirm actual specifications of purchased products.

DIMENSIONS AND WEIGHTS

Dimensions and weights are nominal and are not to be used for manufacturing purposes, even when tolerances are shown.

ERRORS AND OMISSIONS

The information in this document has been carefully checked and is believed to be accurate; however, no responsibility is assumed for clerical, typographical, or proofreading errors, or omissions.

PROGRAMMABLE PRODUCTS

OMRON shall not be responsible for the user's programming of a programmable product, or any consequence thereof.

Cat. No. E58E-EN-01

In the interest of product improvement, specifications are subject to change without notice.

OMRON EUROPE B.V.

Wegalaan 67-69,
 NL-2132 JD, Hoofddorp,
 The Netherlands
 Phone: +31 23 568 13 00
 Fax: +31 23 568 13 88
 www.industrial.omron.eu