

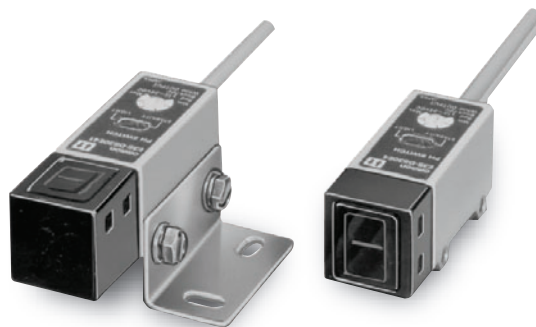

















General-purpose Photoelectric Sensor for High Quality and Reliable Detection



 Be sure to read *Safety Precautions* on page 8.

Ordering Information

General-purpose Sensors

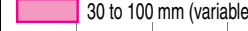
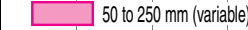
Sensing method	Appearance	Sensing distance	Operation mode	Model
Through-beam *1		 2 m	Light-ON/Dark-ON (selectable)	E3S-2E4 Emitter E3S-2LE4 Receiver E3S-2DE4
		 5 m		E3S-5E4 Emitter E3S-5LE4 Receiver E3S-5DE4
Retro-reflective	 0.1 to 2 m	E3S-R2E4		
Diffuse-reflective		 100 mm		E3S-DS10E4
		 300 mm		E3S-DS30E4
Through-beam *1		 2 m		E3S-2E41 Emitter E3S-2LE41 Receiver E3S-2DE41
		 5 m		E3S-5E41 (42) *2 Emitter E3S-5LE41 (42) Receiver E3S-5DE41 (42)
Retro-reflective		 0.1 to 2 m		E3S-R2E41
Diffuse-reflective		 100 mm		E3S-DS10E41
		 300 mm		E3S-DS30E41 (42) *2
Convergent-reflective (narrow vision field)		 30 to 100 mm (variable)	E3S-LS10XE4	
Convergent-reflective (wide vision field)		 50 to 250 mm (variable)	E3S-LS20XE4	

Note: Sensors with open collectors and different frequencies are available.

*1. Through-beam Sensors are normally sold in sets that include both the Emitter and Receiver.

Orders for individual Emitters and Receivers are accepted.

*2. The difference between the E3S-□□ (□□□) 41 and E3S-□□ (□□□) 42 is in the lens direction when the Sensor is mounted.

For details, refer to the dimensions that are provided on page 10 for the E3S-5E41, page 11 for the E3S-DS30E41, and page 12 for the E3S-5E42 and E3S-DS30E42.

Ratings and Specifications

Sensing method Model Item	Through-beam		Retro-reflective	Diffuse-reflective			Convergent-reflective		
	E3S-2E4 E3S-2E41	E3S-5E4 E3S-5E41 (42)	E3S-R2E4 E3S-R2E41	E3S-DS10E4 E3S-DS10E41	E3S-DS30E41 (42)	E3S-DS30E4S	E3S-LS10XE4	E3S-LS20XE4	
Sensing distance	2 m	5 m	0.1 to 2 m	100 mm (white paper 50 x 50 mm)	300 mm (white paper 100 x 100)		30 to 100 mm Continuously variable (10 x 10 mm)	50 to 250 mm Continuously variable (50 x 75 mm)	
Standard sensing object	Opaque: 7- mm dia. min.	Opaque: 11- mm dia. min.	Opaque: 30- mm dia. min.	Transparent, opaque					
Differential travel	---			20% max. of setting distance			0.5 mm max. at 30 mm	5% max. at 50 to 250 mm	
							3 mm max. at 100 mm		
Directional angle	Both emitter and receiver: 3° to 10°		3° to 10°	---					
Light source (wavelength)	Infrared LED (950 nm)						RED LED (660 nm)	Infrared LED (950 nm)	
Power supply voltage	12 to 24 VDC ±10%, ripple (p-p): 10% max.								
Current consumption	50 mA max. (Emitter: 25 mA max., Receiver: 25 mA max.)		40 mA max.						
Control output (solid-state output)	Output current: 1.5 to 4 mA, Load current: 80 mA max. (residual voltage: 2 V max.) → Refer to page 4.								
Response time	Operate or reset: 3 ms max.		Operate or reset: 1 ms max.						
Sensitivity adjustment	With an indicator								
Ambient illumination (Receiver side) *	Incandescent lamp: 3,000 lx max. Sunlight: 10,000 lx max.								
Ambient temperature	Operating: -25 to 55°C, Storage: -40 to 70°C (with no icing or condensation)								
Ambient humidity	Operating: 35% to 85%, Storage: 35% to 95% (with no condensation)								
Insulation resistance	20 MΩ min. at 500 VDC								
Dielectric strength	1,000 VAC, 50/60 Hz for 1 min								
Vibration resistance (destruction)	10 to 55 Hz, 1.5-mm double amplitude for 2 hours each in X, Y, and Z directions								
Shock resistance (destruction)	500 m/s ² 3 times each in X, Y, and Z directions								
Degree of protection	IEC IP65	IEC IP67		IEC IP65	IEC IP67				
Connection method	Pre-wired cable (standard length: 2 m)								
Indicators	Light indicator (red), Stability indicator (green)								
Material	Case	Polybutylene terephthalate	Zinc die-cast		Polybutylene terephthalate	Zinc die-cast			
	Lens *	Polycarbonate							
	Mounting Bracket	Iron							

* The ambient operating illumination is the illumination that changes the output ±20% at 200 lx. It is not the operational limit.

Engineering Data (Typical)

Parallel Operating Range

E3S-2E4 (41)

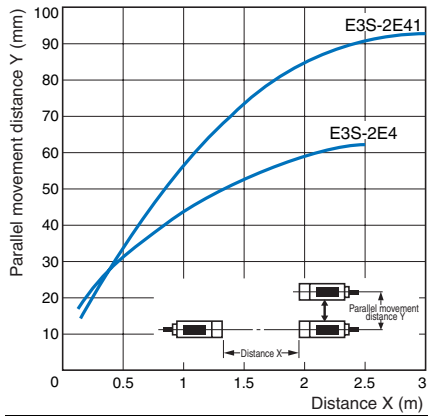

E3S-5E4 (41) (42)

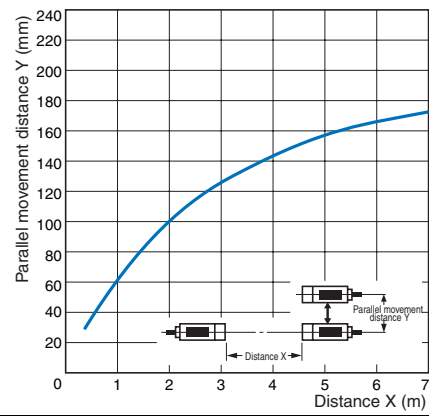

Operating Range

E3S-DS10E4 (41)

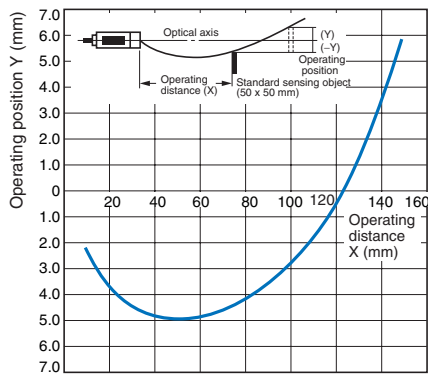

E3S-DS30E4 (41) (42)

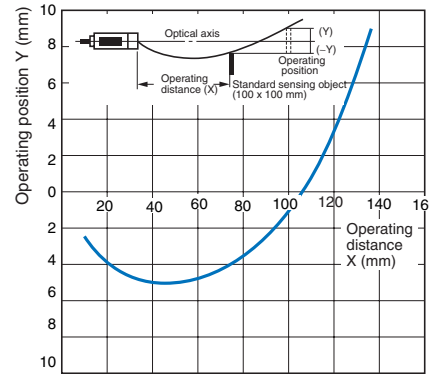

E3S-LS10XE4

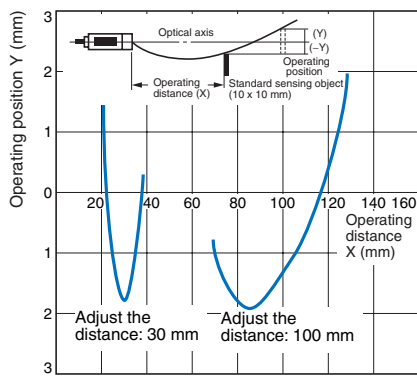

E3S-LS20XE4

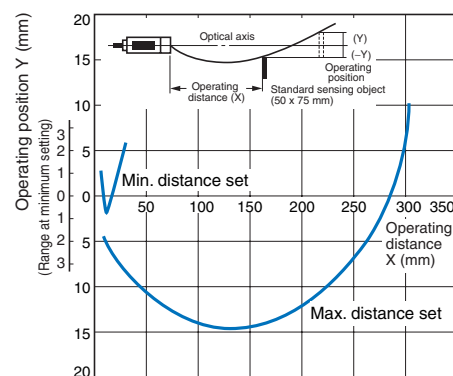

Sensing Distance vs. Size of Sensing Object

E3S-DS30E4 (41) (42)

E3S-DS10E4 (41)

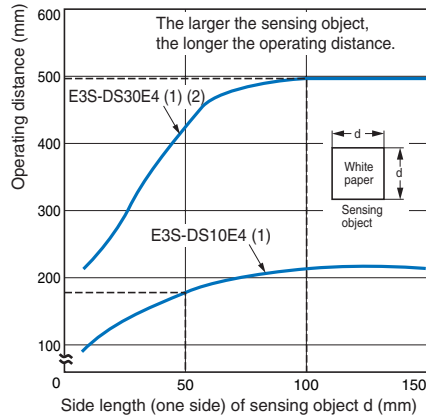

E3S-LS20XE4

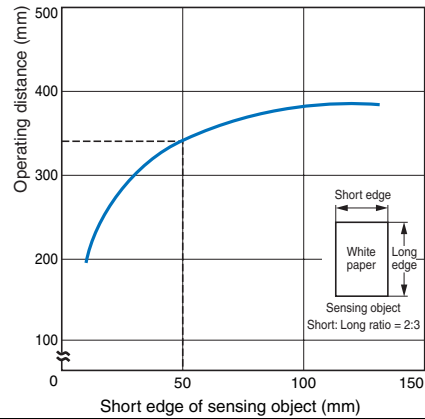

Parallel Operating Range

E3S-R2E4 (41) (42)

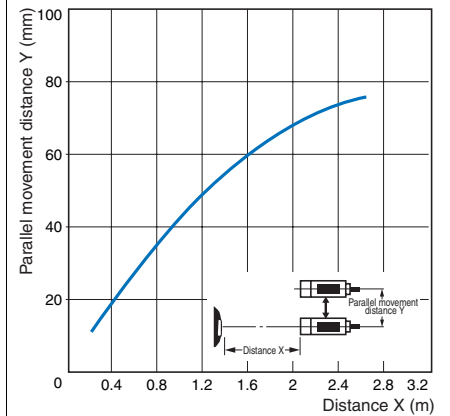

Excess Gain vs. Set Distance

E3S-LS10XE4

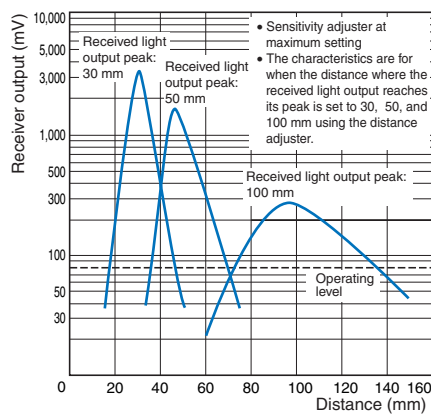

E3S-LS3RC4

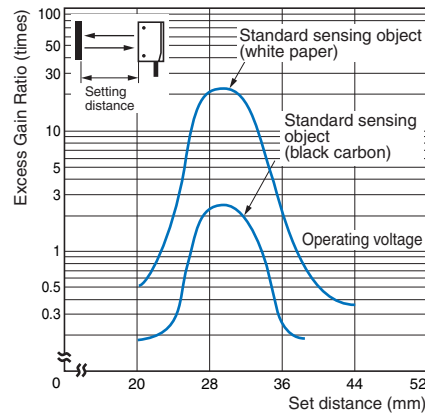

Load Residual Voltage Characteristics

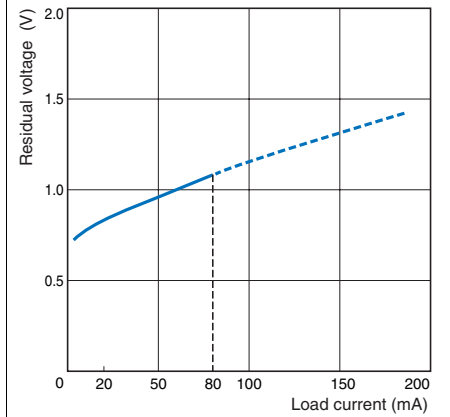

I/O Circuit Diagrams

Model	Wire color	Item Power polarity	Operation mode	Output circuit	Timing charts
E3S	Brown	+	Light-ON	<p>Z: Zener diode ($V_z = 30\text{ V}$) *1: Reverse the polarity of the power supply to switch the operating mode. *2: Voltage output (when connecting transistor circuit)</p>	Incident light: ON (green bar) No incident light: OFF (white bar) Light indicator (red): ON (green bar), OFF (white bar) Output transistor: ON (green bar), OFF (white bar) Load 1 (e.g., relay): Operate (green bar) Load 2: Reset (Between brown and black) (white bar), H (green bar), L (Between blue and black) (white bar)
	Blue	0 V			Incident light: ON (green bar) No incident light: OFF (white bar) Light indicator (red): ON (green bar), OFF (white bar) Output transistor: ON (green bar), OFF (white bar) Load 1 (e.g., relay): Operate (green bar) Load 2: Reset (Between brown and black) (white bar), H (green bar), L (Between blue and black) (white bar)
	Brown	0 V	Dark-ON	<p>Z: Zener diode ($V_z = 30\text{ V}$) *1: Reverse the polarity of the power supply to switch the operating mode. *2: Voltage output (when connecting transistor circuit)</p>	Incident light: ON (green bar) No incident light: OFF (white bar) Light indicator (red): ON (green bar), OFF (white bar) Output transistor: ON (green bar), OFF (white bar) Load 1 (e.g., relay): Operate (green bar) Load 2: Reset (Between blue and black) (white bar), H (green bar), L (Between brown and black) (white bar)
	Blue	+			Incident light: ON (green bar) No incident light: OFF (white bar) Light indicator (red): ON (green bar), OFF (white bar) Output transistor: ON (green bar), OFF (white bar) Load 1 (e.g., relay): Operate (green bar) Load 2: Reset (Between blue and black) (white bar), H (green bar), L (Between brown and black) (white bar)

Connection

● With Relay Load

Through-beam Sensors

Light Interrupted and Load Operating for E3S-2E4 (41) and -5E4 (41) (42)

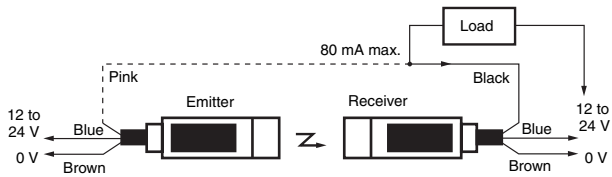

Note: The indicator will function as a light indication if the Emitter's pink wire is connected to the Receiver's black wire as indicated by the dotted line. The indicator will function as a power indicator if the Emitter's pink wire is connected to the Emitter's blue wire.

Retro-reflective Sensors

Light Interrupted and Load Operating for E3S-R2E4 (41) (42), -DS10E4(41), and -DS30E4 (41) (42)

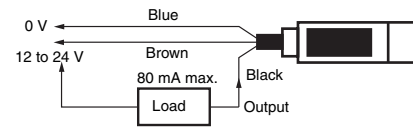

● Connection with S3D2 Sensor Controller

Reverse operation is possible using the signal input switch on the S3D2.

Sensing method	Through-beam	Reflective
Connection method		

Adjustment Methods

● Adjusting the E3S-LS10XE4 Convergent-reflective Sensor

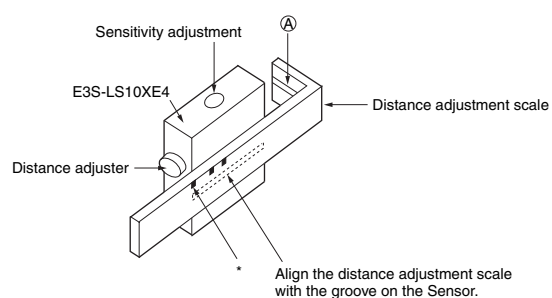

1. Attach the distance adjustment scale as shown in the figure and set it where the * mark is equal to the sensing distance.
2. Turn the distance adjuster until the red spot is at point A (center of the distance adjustment scale).
3. Remove the distance adjustment scale once the distance has been adjusted. Put a sensing object in place, and then adjust the sensitivity.

● Adjusting the E3S-LS20XE4 Convergent-reflective Sensor

Adjustment Method 1

Use this method if the sensing object is more reflective than the background.

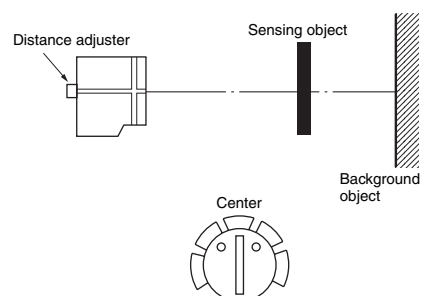

1. Set the sensitivity adjuster to the center as shown in the figure.
2. Turn the distance adjuster counterclockwise until it is fully turned (L to S).
3. Position the sensing object.
4. Slowly turn the distance adjuster clockwise (S to L).
5. Eventually the LIGHT (red) indicator will light. Turning the adjuster further will light the STABILITY (green) indicator. Leave the distance adjuster at this level.
6. Adjust the sensitivity in this state.

Adjustment Method 2

Use this method if the background is more reflective than the sensing object.

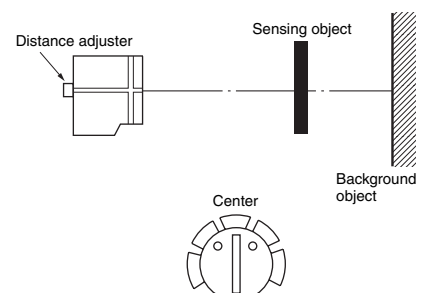

1. Set the sensitivity adjuster to the center as shown in the figure.
2. Turn the distance adjuster clockwise until it is fully turned (S to L).
3. Remove the sensing object.
4. Slowly turn the distance adjuster counterclockwise (L to S).
5. Eventually the LIGHT (red) indicator will light. Turning the adjuster further will light the STABILITY (green) indicator.
6. Adjust the sensitivity in this state.

Safety Precautions

⚠ WARNING

This product is not designed or rated for ensuring safety of persons. Do not use it for such purposes.



Precautions for Correct Use

Do not use the product in atmospheres or environments that exceed product ratings.

If the sensing object has a metallic or shiny surface, the E3S-R may not detect it properly. To avoid this situation, place the sensing object so that it is not at right angles to the Photoelectric Sensor.

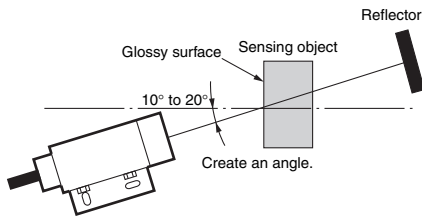

● **Attaching the E39-S Slit**

- The Slit can be fitted vertically or horizontally as indicated by the dotted line. Make sure that Slits for the Emitter and the Receiver are fitted in the same orientation.
- Place the packing in the supporter and hook the claws on the indentations in the Sensor head.
- If the supporter is contacting the mounting surface, insert a spacer to separate it. (Refer to *Slit Dimensions*.)
- An operating position accuracy of 0.1 mm max. can be achieved for a Through-beam Sensor without Slits.

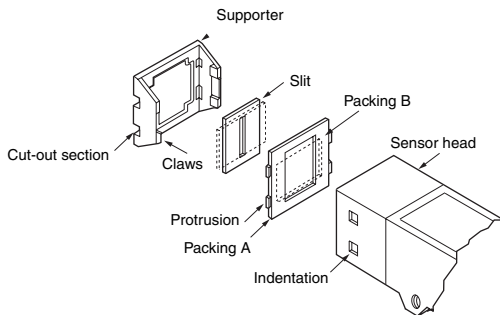

Sensor with Slits

Applicable Photoelectric Sensor Model	E3S-5E4, -5E41 (42)				E3S-2E4, -2E41		
	E39-S1				E39-S2		
	0.5 mm	1 mm	2 mm	4 mm	0.5 mm	1 mm	2 mm
Sensing distance	230 mm	580 mm	1200 mm	2500 mm	170 mm	420 mm	820 mm
Sensing object	0.5 mm	1 mm	2 mm	4 mm	0.5 mm	1 mm	2 mm
Degree of protection	IP60						

● **Sensors with Open-collector Outputs**

Sensors with Open-collector Outputs

Type	Output type	Output transistor	Rated current output	Switching current	Output protection circuit
E	Voltage or current output	NPN	1.5 to 4 mA	80 mA max. (sinking)	Provided against an increase in the residual output voltage
C	Open-collector output	NPN	—	100 mA max. (sinking)	Provided: Output transistor cutoff
B	Open-collector output	PNP	—	100 mA max. (sourcing)	Provided: Output transistor cutoff

The model numbers are as follows:

- Example:
 E3S-DS10E4 (E type)
 E3S-DS1C4 (C type)
 E3S-DS1B4 (B type)

C4 (C41, C42) Sensors

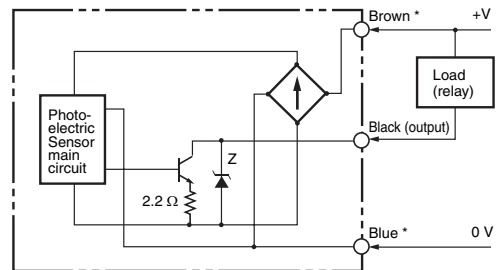

C4 (B41, B42) Sensors

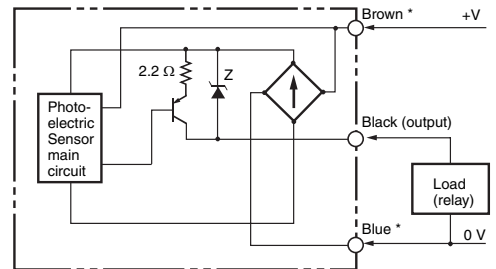

Z: Zener diode (Vz = 30 V)

* The operation mode depends on the wiring of the brown and blue lines.

- Note 1. Only C42 models with die-cast cases are available.
 2. The Emitter for a Through-beam C4-type Sensor is the same as the Emitter for an E4-type Sensor. (E.g., E3S-5LE4)
 3. When a C- or B- type Sensor experiences a load short-circuit or overload, the output transistor will be turned OFF. Check the load conditions before turning the power back ON.

● Sensors with Different Orientations

The E3S-5, E3S-DS30, and E3S-R2 that sense in different directions can be made.

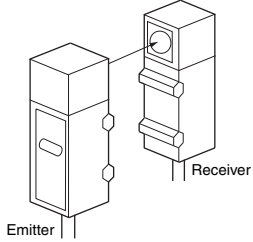
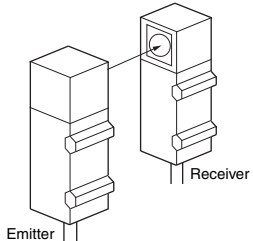
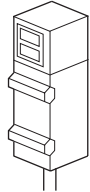
Sensing method	Sensing direction
Through-beam	E3S-5E43 
	E3S-5E44 
Retro-reflective Diffuse-reflective	E3S-DS30E43 E3S-R2E43 

E3S-5E42

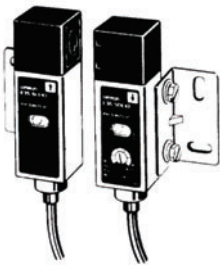

4-dia. vinyl-insulated round cable with 2/3 conductors
(Conductor cross section: 0.2 mm²,
Insulator diameter: 1.1 mm),
Standard length: 2 m
Weight: Approx. 165 g

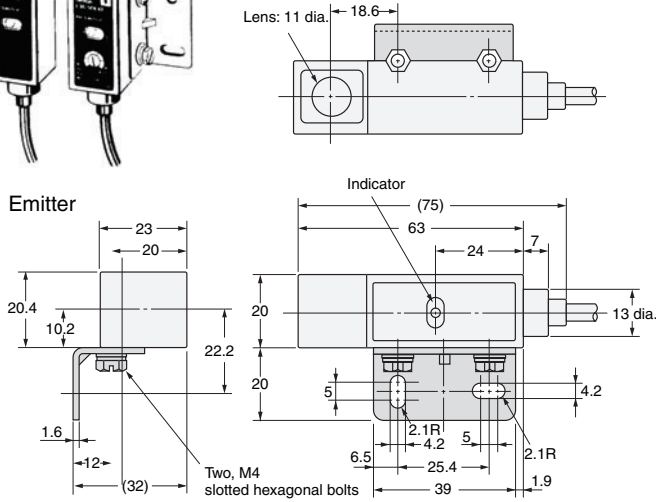

Receiver

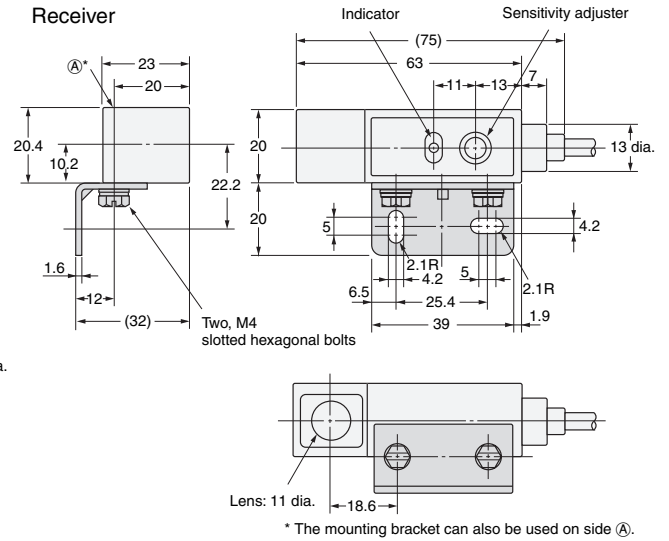

* The mounting bracket can also be used on side (A).

E3S-R2E4

E3S-DS30E42



4-dia. vinyl-insulated round cable with 3 conductors
(Conductor cross section: 0.2 mm², Insulator diameter: 1.1 mm),
Standard length: 2 m
Weight: Approx. 165 g

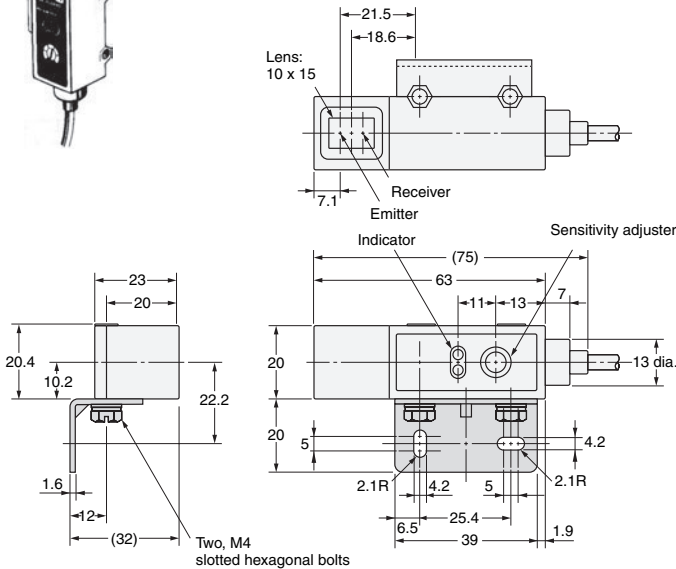

E3S-LS10XE4

E3S-LS20XE4

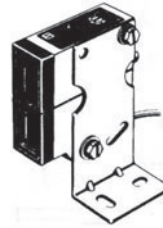

4-dia. vinyl-insulated round cable with 3 conductors
(Conductor cross section: 0.2 mm², Insulator diameter: 1.1 mm),
Standard length: 2 m
Weight: Approx. 225 g

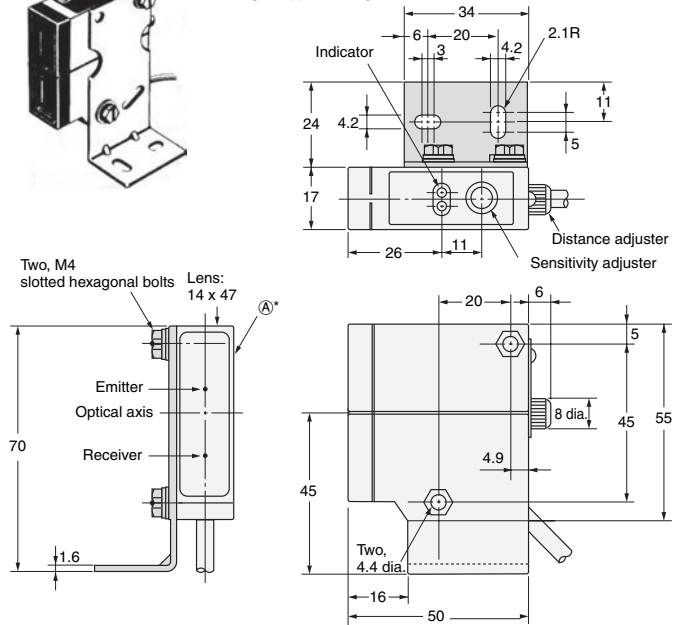

* The mounting bracket can also be used on side (A).

Note: Models numbers for Through-beam Sensors (E3S-5E42) are for sets that include both the Emitter and Receiver.

The model number of the Emitter is expressed by adding "L" to the set model number (example: E3S-5LE42), the model number of the Receiver, by adding "D"
(example: E3S-5DE42.) Refer to Ordering Information to confirm model numbers for Emitter and Receivers.

Mounting Hole Dimensions

E3S-2E4
E3S-2E41
E3S-DS10E4
E3S-DS10E41

E3S-LS10XE4
E3S-LS20XE4

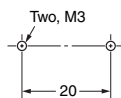

E3S-5E4
E3S-5E41
E3S-R2E4
E3S-R2E41 (42)

E3S-DS30E4
E3S-DS30E41 (42)

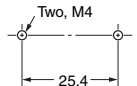

Accessories (Order Separately)

Special Mounting Bracket

E39-L2

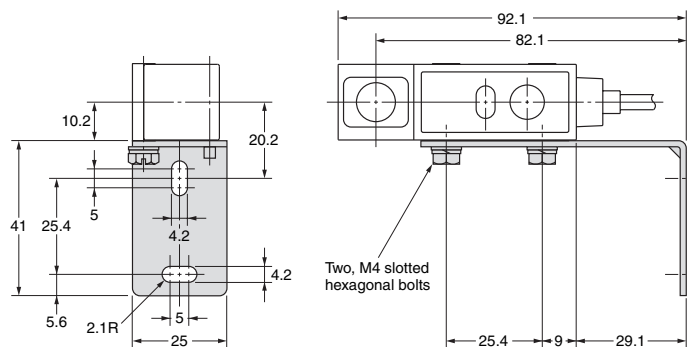
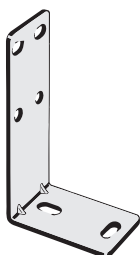

Mounting Holes

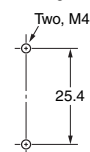

Applicable models:
E3S-5E41
E3S-R2E41
E3S-DS30E41

E39-L4

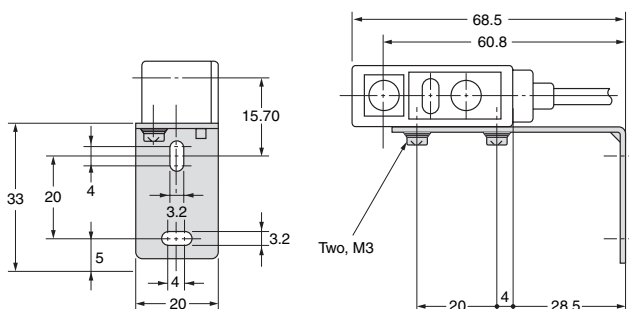
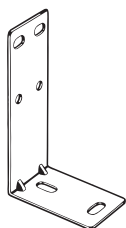

Mounting Holes

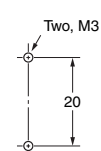

Applicable models:
E3S-2E41
E3S-DS10E41

Reflector

E39-R1

(Provided with the E3S-R2E4(41) Retro-reflective Reflector.)



Material:
Reflective surface: Acrylic
Rear surface: ABS

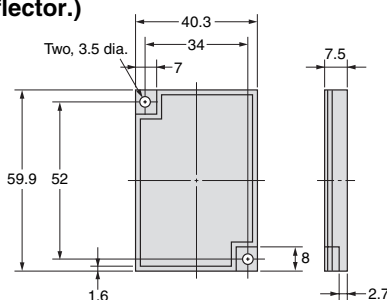

Sensitivity Adjuster (Provided)

E39-G1

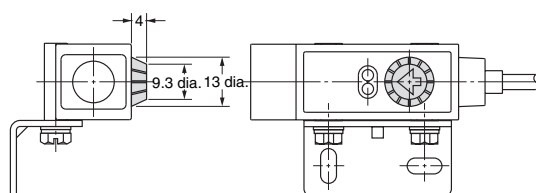

Applicable models:
Provided with the E3S-5E4(41), E3S-DS30E4(41), E3S-R2E4(41).
Note: Cannot be used for the E3S-DS10E4 (41).

Slit (Order Separately)

E39-S2

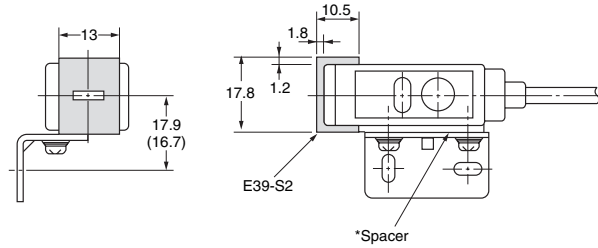

Slit	E39-S2
Applicable Sensors	E3S-2E4 E3S-2E41

Note 1. Three sets of slits are provided:
6.5 x 0.5 mm, 6.5 x 1 mm and 6.5 x 2 mm
2. One set consists of two slits, one each for the Emitter and Receiver.

E39-S1

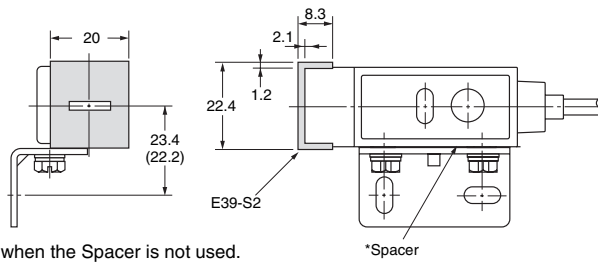
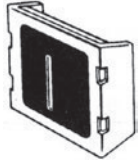

Slit	E39-S1
Applicable Sensors	E3S-5E4 E3S-5E41

Note 1. Four sets of slits are provided:
11 x 0.5 mm, 11 x 1 mm, 11 x 2 mm, and 11 x 4 mm
2. One set consists of two slits, one each for the Emitter and Receiver.

Note: The dimensions in parentheses are for when the Spacer is not used.

* With the E3S-2E4 (41), use the Spacer as shown in the figure above so that the supporter and Mounting Bracket will not be struck when the optical axis is adjusted.

With the E3S-5E4 (41), the Spacer is not particularly required. Use the Spacer, however, to directly mount both the E3S-2E4 (41) and -5E4 (41).

In the interest of product improvement, specifications are subject to change without notice.

Read and Understand This Catalog

Please read and understand this catalog before purchasing the products. Please consult your OMRON representative if you have any questions or comments.

Warranty and Limitations of Liability

WARRANTY

OMRON's exclusive warranty is that the products are free from defects in materials and workmanship for a period of one year (or other period if specified) from date of sale by OMRON.

OMRON MAKES NO WARRANTY OR REPRESENTATION, EXPRESS OR IMPLIED, REGARDING NON-INFRINGEMENT, MERCHANTABILITY, OR FITNESS FOR PARTICULAR PURPOSE OF THE PRODUCTS. ANY BUYER OR USER ACKNOWLEDGES THAT THE BUYER OR USER ALONE HAS DETERMINED THAT THE PRODUCTS WILL SUITABLY MEET THE REQUIREMENTS OF THEIR INTENDED USE. OMRON DISCLAIMS ALL OTHER WARRANTIES, EXPRESS OR IMPLIED.

LIMITATIONS OF LIABILITY

OMRON SHALL NOT BE RESPONSIBLE FOR SPECIAL, INDIRECT, OR CONSEQUENTIAL DAMAGES, LOSS OF PROFITS OR COMMERCIAL LOSS IN ANY WAY CONNECTED WITH THE PRODUCTS, WHETHER SUCH CLAIM IS BASED ON CONTRACT, WARRANTY, NEGLIGENCE, OR STRICT LIABILITY.

In no event shall the responsibility of OMRON for any act exceed the individual price of the product on which liability is asserted.

IN NO EVENT SHALL OMRON BE RESPONSIBLE FOR WARRANTY, REPAIR, OR OTHER CLAIMS REGARDING THE PRODUCTS UNLESS OMRON'S ANALYSIS CONFIRMS THAT THE PRODUCTS WERE PROPERLY HANDLED, STORED, INSTALLED, AND MAINTAINED AND NOT SUBJECT TO CONTAMINATION, ABUSE, MISUSE, OR INAPPROPRIATE MODIFICATION OR REPAIR.

Application Considerations

SUITABILITY FOR USE

OMRON shall not be responsible for conformity with any standards, codes, or regulations that apply to the combination of products in the customer's application or use of the products.

At the customer's request, OMRON will provide applicable third party certification documents identifying ratings and limitations of use that apply to the products. This information by itself is not sufficient for a complete determination of the suitability of the products in combination with the end product, machine, system, or other application or use.

The following are some examples of applications for which particular attention must be given. This is not intended to be an exhaustive list of all possible uses of the products, nor is it intended to imply that the uses listed may be suitable for the products:

- Outdoor use, uses involving potential chemical contamination or electrical interference, or conditions or uses not described in this catalog.
- Nuclear energy control systems, combustion systems, railroad systems, aviation systems, medical equipment, amusement machines, vehicles, safety equipment, and installations subject to separate industry or government regulations.
- Systems, machines, and equipment that could present a risk to life or property.

Please know and observe all prohibitions of use applicable to the products.

NEVER USE THE PRODUCTS FOR AN APPLICATION INVOLVING SERIOUS RISK TO LIFE OR PROPERTY WITHOUT ENSURING THAT THE SYSTEM AS A WHOLE HAS BEEN DESIGNED TO ADDRESS THE RISKS, AND THAT THE OMRON PRODUCTS ARE PROPERLY RATED AND INSTALLED FOR THE INTENDED USE WITHIN THE OVERALL EQUIPMENT OR SYSTEM.

PROGRAMMABLE PRODUCTS

OMRON shall not be responsible for the user's programming of a programmable product, or any consequence thereof.

Disclaimers

CHANGE IN SPECIFICATIONS

Product specifications and accessories may be changed at any time based on improvements and other reasons.

It is our practice to change model numbers when published ratings or features are changed, or when significant construction changes are made. However, some specifications of the products may be changed without any notice. When in doubt, special model numbers may be assigned to fix or establish key specifications for your application on your request. Please consult with your OMRON representative at any time to confirm actual specifications of purchased products.

DIMENSIONS AND WEIGHTS

Dimensions and weights are nominal and are not to be used for manufacturing purposes, even when tolerances are shown.

PERFORMANCE DATA

Performance data given in this catalog is provided as a guide for the user in determining suitability and does not constitute a warranty. It may represent the result of OMRON's test conditions, and the users must correlate it to actual application requirements. Actual performance is subject to the OMRON Warranty and Limitations of Liability.

ERRORS AND OMISSIONS

The information in this document has been carefully checked and is believed to be accurate; however, no responsibility is assumed for clerical, typographical, or proofreading errors, or omissions.

2011.9

In the interest of product improvement, specifications are subject to change without notice.

OMRON Corporation
Industrial Automation Company

<http://www.ia.omron.com/>

(c)Copyright OMRON Corporation 2011 All Right Reserved.