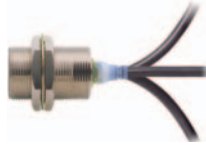



Your Search for Proximity Sensors Starts with the World-leading Performance and Quality of the E2E

- Standard Sensors for detecting ferrous metals.
- Wide array of variations. Ideal for a variety of applications.
- Models with different frequencies are also available to prevent mutual interference.
- Superior environment resistance with standard cable made of oil-resistant PVC and sensing surface made of material that resists cutting oil.
- Useful to help prevent disconnection. Cable protector provided as a standard feature.



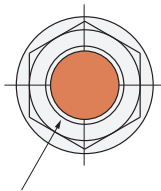
 Be sure to read *Safety Precautions* on page 25.

For the most recent information on models that have been certified for safety standards, refer to your OMRON website.

Features

2-Wire Models

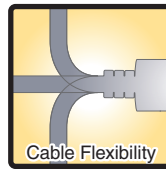
Pre-wired Models with Oil-resistant Reinforced PUR Cables Added to the Lineup and Easy Differentiation with Orange Head



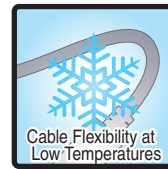
Differentiation from standard models: Orange Head



Oil Resistance (Insulation service life): twice or three times that of oil-resistant vinyl chloride

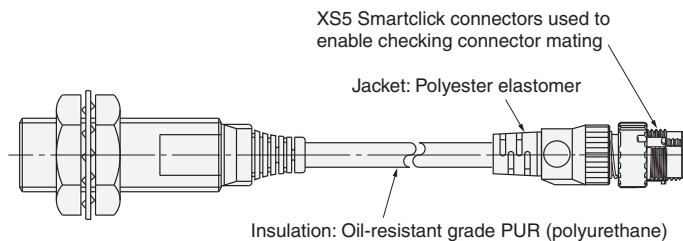
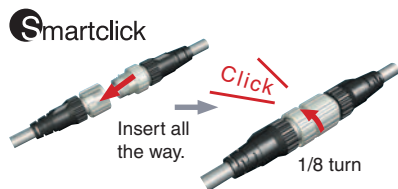


Cable Flexibility: approximately twice that of vinyl chloride cables



More Flexibility at -40°C

Lineup includes models with Smartclick pre-wired connectors for fast connection.



Lineup includes models with self-diagnostic output to provide notification of failures and unstable detection conditions, such as coil burnout.

- Contributes to preventive maintenance to keep the line from stopping.

Reduced wiring, fewer resources, and low power consumption contribute to environmentalism.

- Wiring work and amount of copper wire used reduced to two thirds of that required for 3-wire models.
- Current consumption drastically reduced to less than 10% (when a DC 2-wire model is compared with a DC 3-wire model).

3-Wire Models**Lineup includes models with small diameter (3 dia., 4 dia., 5.4 dia., M5)**

- All small-diameter models use sealed construction. Operation is stable even when the Sensor is mounted in a small space or embedded in metal.
- Bright indicators enable easily checking the installation condition.

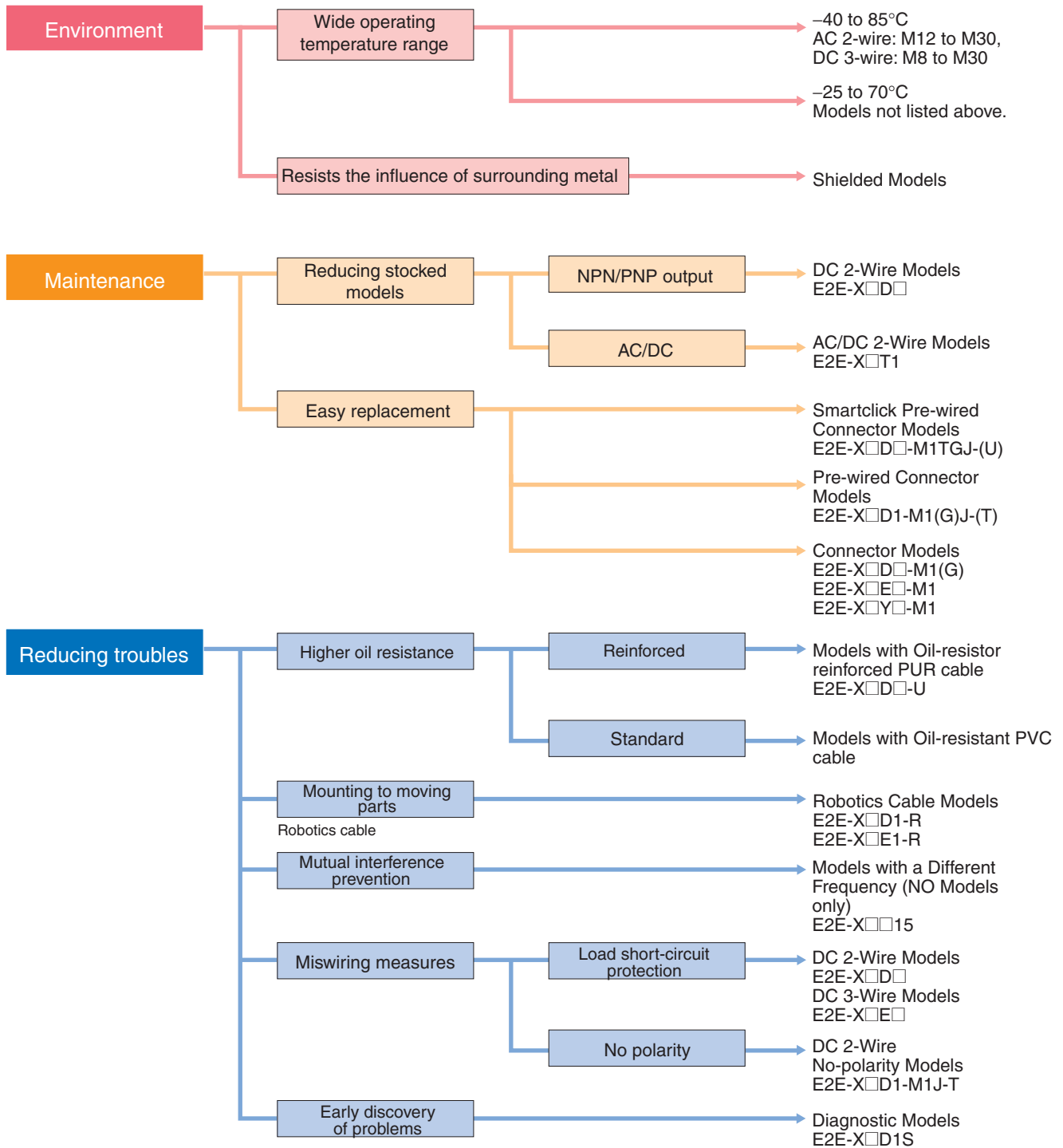
**Wide range of ambient operating temperatures: -40°C to 85°C (M8 to M30 models)**

- Wide range of ambient operating temperatures also for small-diameter models: -25°C to 70°C
- Suitable for low-temperature and high-temperature applications, which are troublesome for photoelectric sensors.

Lineup includes models with flexible cable (4-dia. to M30 models)

- Reduced risk of disconnection in applications with moving parts.

E2E Guide to Selection by Purpose



Note: Refer to *Models Not Listed in this Catalog* for Long Body Models, Transmission Couplers, and Power Couplers.

E2E Model Number Legend

E2E- ① ② ③ ④ ⑤ ⑥ ⑦ - ⑧ ⑨ - ⑩ - ⑪ - ⑫ ⑬

| No. | Classification | Code | Meaning | Remarks |
|-----|--|----------|---|---|
| ① | Appearance | C | Cylindrical (not threaded) | |
| | | X | Cylindrical (threaded) | |
| ② | Sensing distance | Number | Sensing distance (Unit: mm) | Example: R6: 0.6 mm 1R5: 1.5 mm |
| | | R | Indication of decimal point | |
| ③ | Shielding | Blank | Shielded Models | |
| | | M | Unshielded Models | |
| ④ | Power supply and output specifications | B | DC 3-wire PNP open-collector output | Whether D models have polarity is defined by number ⑩. |
| | | C | DC 3-wire NPN open-collector output | |
| | | D | DC 2-wire polarity/no polarity | |
| | | E | DC 3-wire NPN collector load built-in output | |
| | | F | DC 3-wire PNP collector load built-in output | |
| | | T | AC/DC 2-wire | |
| | | Y | AC 2-wire | |
| ⑤ | Form of output switching element | 1 | Normally open (NO) | |
| | | 2 | Normally closed (NC) | |
| ⑥ | Oscillation frequency type | Blank | Standard frequency | Used to prevent mutual interference. |
| | | 5 | Different frequency | |
| ⑦ | Self-diagnosis | Blank | No | |
| | | 5 | Yes | |
| ⑧ | Connection method | Blank | Pre-wired | |
| | | M1 | M12-size metal connector | |
| | | M3 | M8-size metal connector | |
| ⑨ | Connector specifications | Blank | Connector Models DC 3-wire and AC 2-wire, DC 2-wire with self-diagnosis output, DC 2-wire with old pin arrangement | |
| | | G | Connector Models DC 2-wire with IEC pin arrangement | |
| | | J | Pre-wired Connector Models DC 3-wire and AC 2-wire, DC 2-wire with old pin arrangement | |
| | | GJ | Pre-wired Connector Models DC 2-wire with IEC pin arrangement | |
| | | TJ | Pre-wired Smartclick Connector Models DC 2-wire | |
| | | TGJ | Pre-wired Smartclick Connector Models DC 2-wire with IEC pin arrangement | |
| ⑩ | DC 2-wire polarity | Blank | Polarity | |
| | | T | No polarity | |
| ⑪ | Cable specifications | Blank | Standard PVC cable (oil resistant) | |
| | | R | Flexible PVC cable (oil resistant) | |
| | | U | Polyurethane cable (oil resistant and reinforced) | |
| ⑫ | New model | N | New model (Applies only to DC 2-wire pre-wired and shielded models.) | This is blank if the cable specification in number ⑪ is R or U. |
| ⑬ | Cable length | Letter M | Cable length (Unit: m) (Applicable to Pre-wired Models and Pre-wired Connector Models.) | Example: 2M 0.3M |

Note: The purpose of this model number legend is to provide understanding of the meaning of specifications from the model number. Models are not available for all combinations of code numbers.

Ordering Information

2-Wire Models

Shielded DC 2-wire Models with No Self-diagnostic Output [Refer to *Dimensions* on page 27.]



| Appearance | Sensing distance | | Connection method | Cable specifications | Polarity | Operation mode | Pin arrangement | Applicable connector code *2 | Model | | | |
|---|-------------------------------|---------------|---|-------------------------------|--------------|---|-------------------------------|------------------------------|---|-------------------------------|-----|-----------------------|
| M8 | 2 mm | | M12 Pre-wired Smart-click Connector Models (0.3m) | PUR (increased oil-resistant) | Yes | NO | 1: +V, 4: 0 V | H | E2E-X2D1-M1TGJ-U 0.3M | | | |
| | | | | PVC (oil-resistant) | | NC | 1: +V, 2: 0 V | | E2E-X2D2-M1TGJ-U 0.3M | | | |
| | | | | Pre-wired Models (2 m) | | PUR (increased oil-resistant) | NO | --- | --- | E2E-X2D1-U 2M | | |
| | | | | | | | NC | | | E2E-X2D2-U 2M | | |
| | | | | | | PVC (oil-resistant) | NO | | | E2E-X2D1-N 2M | | |
| | | | | | | | NC | | | E2E-X2D2-N 2M | | |
| | | | M12 Connector Models | --- | NO | 1: +V, 4: 0 V | A | E2E-X2D1-M1G | | | | |
| | | | M8 Connector Models | --- | NC | 1: +V, 2: 0 V | D | E2E-X2D2-M1G | | | | |
| | | | | | NO | 1: +V, 4: 0 V | I | E2E-X2D1-M3G | | | | |
| | | | NC | 1: +V, 2: 0 V | E2E-X2D2-M3G | | | | | | | |
| | | | M12 | 3 mm | | M12 Pre-wired Smart-click Connector Models (0.3m) | PUR (increased oil-resistant) | Yes | NO | 1: +V, 4: 0 V | H | E2E-X3D1-M1TGJ-U 0.3M |
| | | | | | | | PVC (oil-resistant) | | NC | 1: +V, 2: 0 V | | E2E-X3D2-M1TGJ-U 0.3M |
| Pre-wired Models (2 m) | PUR (increased oil-resistant) | NO | | | | | --- | | --- | E2E-X3D1-U 2M | | |
| | | NC | | | | | | | | E2E-X3D2-U 2M | | |
| | PVC (oil-resistant) | NO | | | | | | | | E2E-X3D1-N 2M *1 | | |
| | | NC | | | | | | | | E2E-X3D2-N 2M | | |
| M12 Connector Models | --- | NO | | | | 1: +V, 4: 0 V | A | E2E-X3D1-M1G *1 | | | | |
| M12 Standard Pre-wired Connector Models (0.3 m) | PVC (oil-resistant) | NC | | | | 1: +V, 2: 0 V | D | E2E-X3D2-M1G | | | | |
| | | NO | | | | 1: +V, 4: 0 V | A | E2E-X3D1-M1GJ 0.3M | | | | |
| | | | | | | | | Yes | NC | 1: +V, 2: 0 V | D | E2E-X3D2-M1GJ 0.3M |
| | | | | | | | | | NO | (3, 4): (+V, 0 V) | C | E2E-X3D1-M1J-T 0.3M |
| | | | | | | | | No *3 | NC | (1, 2): (+V, 0 V) | D | --- |
| | | | M18 | 7 mm | | | | | M12 Pre-wired Smart-click Connector Models (0.3m) | PUR (increased oil-resistant) | Yes | NO |
| PVC (oil-resistant) | NC | 1: +V, 2: 0 V | | | | E2E-X7D2-M1TGJ-U 0.3M | | | | | | |
| Pre-wired Models (2 m) | PUR (increased oil-resistant) | NO | | | | --- | --- | E2E-X7D1-U 2M | | | | |
| | | NC | | | | | | E2E-X7D2-U 2M | | | | |
| | PVC (oil-resistant) | NO | | | | | | E2E-X7D1-N 2M *1 | | | | |
| | | NC | | | | | | E2E-X7D2-N 2M | | | | |
| M12 Connector Models | --- | NO | | | | 1: +V, 4: 0 V | A | E2E-X7D1-M1G *1 | | | | |
| M12 Standard Pre-wired Connector Models (0.3 m) | PVC (oil-resistant) | NC | | | | 1: +V, 2: 0 V | D | E2E-X7D2-M1G | | | | |
| | | NO | | | | 1: +V, 4: 0 V | A | E2E-X7D1-M1GJ 0.3M | | | | |
| | | | | | | | | Yes | NC | 1: +V, 2: 0 V | D | E2E-X7D2-M1GJ 0.3M |
| | | | | | | | | | NO | (3, 4): (+V, 0 V) | C | E2E-X7D1-M1J-T 0.3M |
| | | | | | | | | No *3 | NC | (1, 2): (+V, 0 V) | D | E2E-X7D2-M1J-T 0.3M |
| | | | M30 | 10 mm | | | | | M12 Pre-wired Smart-click Connector Models (0.3m) | PUR (increased oil-resistant) | Yes | NO |
| PVC (oil-resistant) | NC | 1: +V, 2: 0 V | | | | E2E-X10D2-M1TGJ-U 0.3M | | | | | | |
| Pre-wired Models (2 m) | PUR (increased oil-resistant) | NO | | | | --- | --- | E2E-X10D1-U 2M | | | | |
| | | NC | | | | | | E2E-X10D2-U 2M | | | | |
| | PVC (oil-resistant) | NO | | | | | | E2E-X10D1-N 2M *1 | | | | |
| | | NC | | | | | | E2E-X10D2-N 2M | | | | |
| M12 Connector Models | --- | NO | | | | 1: +V, 4: 0 V | A | E2E-X10D1-M1G *1 | | | | |
| M12 Standard Pre-wired Connector Models (0.3 m) | PVC (oil-resistant) | NC | | | | 1: +V, 2: 0 V | D | E2E-X10D2-M1G | | | | |
| | | NO | | | | 1: +V, 4: 0 V | A | E2E-X10D1-M1GJ 0.3M | | | | |
| | | | | | | | | Yes | NC | 1: +V, 2: 0 V | D | E2E-X10D2-M1GJ 0.3M |
| | | | | | | | | | NO | (3, 4): (+V, 0 V) | C | E2E-X10D1-M1J-T 0.3M |
| | | | | | | | | No *3 | NC | (1, 2): (+V, 0 V) | D | E2E-X10D2-M1J-T 0.3M |

*1. Models with different frequencies are also available. The model number is E2E-X □D15 (example: E2E-X3D15-N 2M).

*2. Refer to page 22 for details.

*3. The residual voltage for models without polarity is 5 V, so use caution concerning the connection load interface conditions (e.g., PLC ON voltage). Refer to page 26

2-Wire Models

Unshielded DC 2-Wire Models with No Self-diagnosis Output [Refer to *Dimensions* on page 27.]

| Appearance | Sensing distance | | | Connection method | Cable specifications | Polarity | Operation mode | Pin arrangement | Applicable connector code *2 | Model | | |
|---|---------------------|----|---|------------------------|----------------------|---|---------------------|-----------------------|------------------------------|---------------|-----------------------|---------------|
| M8 | 4 mm | | | Pre-wired Models (2 m) | PVC (oil-resistant) | Yes | NO | --- | --- | E2E-X4MD1 2M | | |
| | | | | M12 Connector Models | --- | | NC | | | E2E-X4MD2 2M | | |
| | | | | M8 Connector Models | --- | | NO | | | 1: +V, 4: 0 V | A | E2E-X4MD1-M1G |
| | | | | | | | NC | | | 1: +V, 2: 0 V | D | E2E-X4MD2-M1G |
| | | | | | | | NO | | | 1: +V, 4: 0 V | I | E2E-X4MD1-M3G |
| | | | | | | | NC | | | 1: +V, 2: 0 V | | E2E-X4MD2-M3G |
| M12 | 8 mm | | M12 Pre-wired Smart-click Connector Models (0.3m) | PVC (oil-resistant) | NO | | 1: +V, 4: 0 V | G | E2E-X8MD1-M1TGJ 0.3M | | | |
| | | | | | NO | | --- | --- | E2E-X8MD1 2M *1 | | | |
| | | | Pre-wired Models (2 m) | PVC (oil-resistant) | NC | | --- | --- | E2E-X8MD2 2M | | | |
| | | | | | NO | | 1: +V, 4: 0 V | A | E2E-X8MD1-M1G *1 | | | |
| | | | M12 Connector Models | --- | NC | | 1: +V, 2: 0 V | D | E2E-X8MD2-M1G | | | |
| | | | | | NO | | 1: +V, 4: 0 V | A | E2E-X8MD1-M1GJ 0.3M | | | |
| | | | M12 Standard Pre-wired Connector Models (0.3 m) | PVC (oil-resistant) | NC | 1: +V, 2: 0 V | D | --- | | | | |
| | | | | | NO | 1: +V, 4: 0 V | A | E2E-X14MD1-M1TGJ 0.3M | | | | |
| | | | M18 | 14 mm | | M12 Pre-wired Smart-click Connector Models (0.3m) | PVC (oil-resistant) | NO | 1: +V, 4: 0 V | G | E2E-X14MD1-M1TGJ 0.3M | |
| | | | | | | | | NO | --- | --- | E2E-X14MD1 2M *1 | |
| Pre-wired Models (2 m) | PVC (oil-resistant) | NC | | | | --- | --- | E2E-X14MD2 2M | | | | |
| | | NO | | | | 1: +V, 4: 0 V | A | E2E-X14MD1-M1G *1 | | | | |
| M12 Connector Models | --- | NC | | | | 1: +V, 2: 0 V | D | E2E-X14MD2-M1G | | | | |
| | | NO | | | | 1: +V, 4: 0 V | A | E2E-X14MD1-M1GJ 0.3M | | | | |
| M12 Standard Pre-wired Connector Models (0.3 m) | PVC (oil-resistant) | NC | | | | 1: +V, 2: 0 V | D | E2E-X14MD2-M1GJ 0.3M | | | | |
| | | NO | | | | 1: +V, 4: 0 V | G | E2E-X20MD1-M1TGJ 0.3M | | | | |
| M30 | 20 mm | | M12 Pre-wired Smart-click Connector Models (0.3m) | PVC (oil-resistant) | NO | 1: +V, 4: 0 V | G | E2E-X20MD1-M1TGJ 0.3M | | | | |
| | | | | | NO | --- | --- | E2E-X20MD1 2M *1 | | | | |
| | | | Pre-wired Models (2 m) | PVC (oil-resistant) | NC | --- | --- | E2E-X20MD2 2M | | | | |
| | | | | | NO | 1: +V, 4: 0 V | A | E2E-X20MD1-M1G *1 | | | | |
| | | | M12 Connector Models | --- | NC | 1: +V, 2: 0 V | D | E2E-X20MD2-M1G | | | | |
| | | | | | NO | 1: +V, 4: 0 V | A | E2E-X20MD1-M1GJ 0.3M | | | | |
| | | | M12 Standard Pre-wired Connector Models (0.3 m) | PVC (oil-resistant) | NC | 1: +V, 2: 0 V | D | --- | | | | |
| | | | | | NO | 1: +V, 4: 0 V | A | E2E-X20MD1-M1GJ 0.3M | | | | |

*1. Models with different frequencies are also available. The model number is E2E-X □D15 (example: E2E-X8MD15 2M).

*2. Refer to page 22 for details.

Shielded DC 2-Wire Models with Self-diagnosis Output [Refer to *Dimensions* on page 27.]

| Appearance | Sensing distance | | | Connection method | Cable specifications | Polarity | Operation mode | Pin arrangement | Applicable connector code *2 | Model |
|------------|------------------|--|--|------------------------|----------------------|----------|----------------|---|------------------------------|------------------|
| M12 | 3 mm | | | Pre-wired Models (2 m) | PVC (oil-resistant) | Yes | NO | --- | --- | E2E-X3D1S 2M *1 |
| | | | | M12 Connector Models | --- | | | 2: +V and diagnostic output 3: 0 V 4: +V and control output | D | E2E-X3D1S-M1 |
| M18 | 7 mm | | | Pre-wired Models (2 m) | PVC (oil-resistant) | | | --- | --- | E2E-X7D1S 2M *1 |
| | | | | M12 Connector Models | --- | | | 2: +V and diagnostic output 3: 0 V 4: +V and control output | D | E2E-X7D1S-M1 |
| M30 | 10 mm | | | Pre-wired Models (2 m) | PVC (oil-resistant) | | | --- | --- | E2E-X10D1S 2M *1 |
| | | | | M12 Connector Models | --- | | | 2: +V and diagnostic output 3: 0 V 4: +V and control output | D | E2E-X10D1S-M1 |

*1. Models with different frequencies are also available. The model number is E2E-X □D15S (example: E2E-X3D15S 2M).

*2. Refer to page 22 for details.

2-Wire Models

Unshielded DC 2-Wire Models with Self-diagnosis Output [Refer to Dimensions on page 27.]



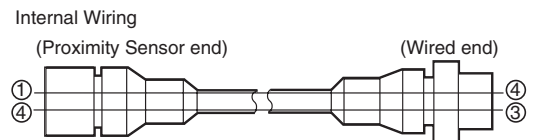
| Appearance | Sensing distance | | Connection method | Cable specifications | Polarity | Operation mode | Pin arrangement | Applicable connector code *2 | Model | |
|------------|------------------|--|------------------------|----------------------|----------|----------------|---|------------------------------|------------------|-------------------|
| M12 | 8 mm | | Pre-wired Models (2 m) | PVC (oil-resistant) | Yes | NO | --- | --- | E2E-X8MD1S 2M *1 | |
| | | | M12 Connector Models | --- | | | 2: +V and diagnostic output 3: 0 V 4: +V and control output | D | E2E-X8MD1S-M1 | |
| M18 | 14 mm | | Pre-wired Models (2 m) | PVC (oil-resistant) | | | --- | --- | --- | E2E-X14MD1S 2M *1 |
| | | | M12 Connector Models | --- | | | 2: +V and diagnostic output 3: 0 V 4: +V and control output | D | E2E-X14MD1S-M1 | |
| M30 | 20 mm | | Pre-wired Models (2 m) | PVC (oil-resistant) | | | --- | --- | --- | E2E-X20MD1S 2M *1 |
| | | | M12 Connector Models | --- | | | 2: +V and diagnostic output 3: 0 V 4: +V and control output | D | E2E-X20MD1S-M1 | |

*1. Models with different frequencies are also available. The model number is E2E-X□MD15S (example: E2E-X8MD15S 2M).
 *2. Refer to page 22 for details.

Connector Pin Assignments of DC 2-Wire Models

- The connector pin assignments of each New E2E DC 2-Wire Model conform to IEC 947-5-2 Table III. (Only DC 2-Wire Models have been changed in comparison to the previous models.)
- The following models with conventional connector pin assignments are available as well. (Only NO Models can be used.)
 The cable at the right should also be used if the XW3A-P□45-G11 Connector Junction Box is already being used.

| Cable length | Model |
|--------------|---------------|
| 500 mm | XS2W-D421-BY1 |



Models with conventional connector pin assignments are available as well.

| Appearance | | Model | | | |
|------------|-----|---------------|-----------------------------|---------------|-----------------------------|
| | | NO | Applicable connector code * | NC | Applicable connector code * |
| Shielded | M8 | E2E-X2D1-M1 | C | E2E-X2D2-M1 | D |
| | M12 | E2E-X3D1-M1 | C | E2E-X3D2-M1 | D |
| | M18 | E2E-X7D1-M1 | C | E2E-X7D2-M1 | D |
| | M30 | E2E-X10D1-M1 | C | E2E-X10D2-M1 | D |
| Unshielded | M8 | E2E-X4MD1-M1 | C | E2E-X4MD2-M1 | D |
| | M12 | E2E-X8MD1-M1 | C | E2E-X8MD2-M1 | D |
| | M18 | E2E-X14MD1-M1 | C | E2E-X14MD2-M1 | D |
| | M30 | E2E-X20MD1-M1 | C | E2E-X20MD2-M1 | D |

* Refer to page 22 for details.

2-Wire Models

AC 2-Wire Models Shielded Models [Refer to *Dimensions* on page 27.]

| Appearance | Sensing distance | | Connection method | Cable specifications | Operation mode | Pin arrangement | Applicable connector code *2 | Model |
|------------|------------------|--|------------------------|----------------------|----------------|------------------|------------------------------|-----------------|
| M8 | 1.5 mm | | Pre-wired Models (2 m) | PVC (oil-resistant) | NO | --- | --- | E2E-X1R5Y1 2M |
| | | | | | NC | | | E2E-X1R5Y2 2M |
| M12 | 2 mm | | Pre-wired Models (2 m) | PVC (oil-resistant) | NO | --- | --- | E2E-X2Y1 2M *1 |
| | | | | | NC | | | E2E-X2Y2 2M |
| | | | M12 Connector Models | --- | NO | (3, 4): (AC, AC) | E | E2E-X2Y1-M1 |
| | | | | | NC | (1, 2): (AC, AC) | F | E2E-X2Y2-M1 |
| M18 | 5 mm | | Pre-wired Models (2 m) | PVC (oil-resistant) | NO | --- | --- | E2E-X5Y1 2M *1 |
| | | | | | NC | | | E2E-X5Y2 2M |
| | | | M12 Connector Models | --- | NO | (3, 4): (AC, AC) | E | E2E-X5Y1-M1 |
| | | | | | NC | (1, 2): (AC, AC) | F | E2E-X5Y2-M1 |
| M30 | 10 mm | | Pre-wired Models (2 m) | PVC (oil-resistant) | NO | --- | --- | E2E-X10Y1 2M *1 |
| | | | | | NC | | | E2E-X10Y2 2M |
| | | | M12 Connector Models | --- | NO | (3, 4): (AC, AC) | E | E2E-X10Y1-M1 |
| | | | | | NC | (1, 2): (AC, AC) | F | E2E-X10Y2-M1 |

*1. Models with different frequencies are also available. The model number is E2E-X □Y□5 (example: E2E-X5Y15 2M).

*2. Refer to page 22 for details.

Unshielded Models



| Appearance | Sensing distance | | Connection method | Cable specifications | Operation mode | Pin arrangement | Applicable connector code *2 | Model |
|------------|------------------|--|------------------------|----------------------|----------------|------------------|------------------------------|------------------|
| M8 | 2 mm | | Pre-wired Models (2 m) | PVC (oil-resistant) | NO | --- | --- | E2E-X2MY1 2M |
| | | | | | NC | | | E2E-X2MY2 2M |
| M12 | 5 mm | | Pre-wired Models (2 m) | PVC (oil-resistant) | NO | --- | --- | E2E-X5MY1 2M *1 |
| | | | | | NC | | | E2E-X5MY2 2M |
| | | | M12 Connector Models | --- | NO | (3, 4): (AC, AC) | E | E2E-X5MY1 2M |
| | | | | | NC | (1, 2): (AC, AC) | F | E2E-X5MY2-M1 |
| M18 | 10 mm | | Pre-wired Models (2 m) | PVC (oil-resistant) | NO | --- | --- | E2E-X10MY1 2M *1 |
| | | | | | NC | | | E2E-X10MY2 2M |
| | | | M12 Connector Models | --- | NO | (3, 4): (AC, AC) | E | E2E-X10MY1-M1 |
| | | | | | NC | (1, 2): (AC, AC) | F | E2E-X10MY2-M1 |
| M30 | 18 mm | | Pre-wired Models (2 m) | PVC (oil-resistant) | NO | --- | --- | E2E-X18MY1 2M *1 |
| | | | | | NC | | | E2E-X18MY2 2M |
| | | | M12 Connector Models | --- | NO | (3, 4): (AC, AC) | E | E2E-X18MY1-M1 |
| | | | | | NC | (1, 2): (AC, AC) | F | E2E-X18MY2-M1 |

*1. Models with different frequencies are also available. The model number is E2E-X □MY□5 (example: E2E-X5MY15 2M).

*2. Refer to page 22 for details.

AC 2-Wire Models Shielded Models [Refer to *Dimensions* on page 27.]

(There are no unshielded models.)



| Appearance | Sensing distance | | Connection method | Cable specifications | Operation mode | Pin arrangement | Applicable connector code | Model |
|------------|------------------|--|------------------------|----------------------|----------------|-----------------|---------------------------|--------------|
| M12 | 3 mm | | Pre-wired Models (2 m) | PVC (oil-resistant) | NO | --- | --- | E2E-X3T1 2M |
| M18 | 7 mm | | Pre-wired Models (2 m) | PVC (oil-resistant) | | --- | --- | E2E-X7T1 2M |
| M30 | 10 mm | | Pre-wired Models (2 m) | PVC (oil-resistant) | | --- | --- | E2E-X10T1 2M |

Note: Not compliant with CE.

3-Wire Models

Shielded DC 3-Wire Models [Refer to *Dimensions* on page 27.]

| Appearance | Sensing distance | | Connection method | Cable specifications | Operation mode | Pin arrangement | Applicable connector code *2 | Model | |
|------------|------------------|--|------------------------|----------------------|----------------|----------------------------------|------------------------------|-----------------|----------------|
| | | | | | | | | NPN output | PNP output |
| 3 dia. | 0.6 mm | | Pre-wired Models (2 m) | PVC (oil-resistant) | NO | --- | --- | E2E-CR6C1 2M | E2E-CR6B1 2M |
| | | | | | NC | | | E2E-CR6C2 2M | E2E-CR6B2 2M |
| 4 dia. | 0.8 mm | | Pre-wired Models (2 m) | PVC (oil-resistant) | NO | --- | --- | E2E-CR8C1 2M | E2E-CR8B1 2M |
| | | | | | NC | | | E2E-CR8C2 2M | E2E-CR8B2 2M |
| M5 | 1 mm | | Pre-wired Models (2 m) | PVC (oil-resistant) | NO | --- | --- | E2E-X1C1 2M | E2E-X1B1 2M |
| | | | | | NC | | | E2E-X1C2 2M | E2E-X1B2 2M |
| 5.4 dia. | 1 mm | | Pre-wired Models (2 m) | PVC (oil-resistant) | NO | --- | --- | E2E-C1C1 2M | E2E-C1B1 2M |
| | | | | | NC | | | E2E-C1C2 2M | E2E-C1B2 2M |
| M8 | 1.5 mm | | Pre-wired Models (2 m) | PVC (oil-resistant) | NO | --- | --- | E2E-X1R5E1 2M | E2E-X1R5F1 2M |
| | | | | | NC | | | E2E-X1R5E2 2M | E2E-X1R5F2 2M |
| | | | M12 Connector Models | --- | NO | 1: +V, 3: 0 V, 4: Control output | B | E2E-X1R5E1-M1 | E2E-X1R5F1-M1 |
| | | | | | NC | 1: +V, 3: 0 V, 2: Control output | D | E2E-X1R5E2-M1 | E2E-X1R5F2-M1 |
| | | | M8 Connector Models | --- | NO | 1: +V, 3: 0 V, 4: Control output | I | E2E-X1R5E1-M3 | E2E-X1R5F1-M3 |
| | | | | | NC | 1: +V, 3: 0 V, 2: Control output | | E2E-X1R5E2-M3 | E2E-X1R5F2-M3 |
| M12 | 2 mm | | Pre-wired Models (2 m) | PVC (oil-resistant) | NO | --- | --- | E2E-X2E1 2M *1 | E2E-X2F1 2M *1 |
| | | | | | NC | | | E2E-X2E2 2M | E2E-X2F2 2M |
| | | | M12 Connector Models | --- | NO | 1: +V, 3: 0 V, 4: Control output | B | E2E-X2E1-M1 | E2E-X2F1-M1 |
| | | | | | NC | 1: +V, 3: 0 V, 2: Control output | D | E2E-X2E2-M1 | E2E-X2F2-M1 |
| M18 | 5 mm | | Pre-wired Models (2 m) | PVC (oil-resistant) | NO | --- | --- | E2E-X5E1 2M *1 | E2E-X5F1 2M *1 |
| | | | | | NC | | | E2E-X5E2 2M | E2E-X5F2 2M |
| | | | M12 Connector Models | --- | NO | 1: +V, 3: 0 V, 4: Control output | B | E2E-X5E1-M1 | E2E-X5F1-M1 |
| | | | | | NC | 1: +V, 3: 0 V, 2: Control output | D | E2E-X5E2-M1 | E2E-X5F2-M1 |
| M30 | 10 mm | | Pre-wired Models (2 m) | PVC (oil-resistant) | NO | --- | --- | E2E-X10E1 2M *1 | E2E-X10F1 2M |
| | | | | | NC | | | E2E-X10E2 2M | E2E-X10F2 2M |
| | | | M12 Connector Models | --- | NO | 1: +V, 3: 0 V, 4: Control output | B | E2E-X10E1-M1 | E2E-X10F1-M1 |
| | | | | | NC | 1: +V, 3: 0 V, 2: Control output | D | E2E-X10E2-M1 | E2E-X10F2-M1 |

*1. Models with different frequencies are also available. The model number is E2E-X□□□5 (example: E2E-X5E15 2M).

*2. Refer to page 22 for details.

3-Wire Models

Unshielded DC 3-Wire Models [Refer to *Dimensions* on page 27.]

| Appearance | Sensing distance | | Connection method | Cable specifications | Operation mode | Pin arrangement | Applicable connector code *2 | Model | |
|------------|------------------|--|------------------------|----------------------|----------------|----------------------------------|------------------------------|------------------|---------------|
| | | | | | | | | NPN output | PNP output |
| M8 | 2 mm | | Pre-wired Models (2 m) | PVC (oil-resistant) | NO | --- | --- | E2E-X2ME1 2M | E2E-X2MF1 2M |
| | | | | | NC | | | E2E-X2ME2 2M | E2E-X2MF2 2M |
| | | | M12 Connector Models | --- | NO | 1: +V, 3: 0 V, 4: Control output | B | E2E-X2ME1-M1 | E2E-X2MF1-M1 |
| | | | | | NC | 1: +V, 3: 0 V, 2: Control output | D | E2E-X2ME2-M1 | E2E-X2MF2-M1 |
| | | | M8 Connector Models | --- | NO | 1: +V, 3: 0 V, 4: Control output | I | E2E-X2ME1-M3 | E2E-X2MF1-M3 |
| | | | | | NC | 1: +V, 3: 0 V, 2: Control output | | E2E-X2ME2-M3 | E2E-X2MF2-M3 |
| M12 | 5 mm | | Pre-wired Models (2 m) | PVC (oil-resistant) | NO | --- | --- | E2E-X5ME1 2M *1 | E2E-X5MF1 2M |
| | | | | | NC | | | E2E-X5ME2 2M | E2E-X5MF2 2M |
| | | | M12 Connector Models | --- | NO | 1: +V, 3: 0 V, 4: Control output | B | E2E-X5ME1-M1 | E2E-X5MF1-M1 |
| | | | | | NC | 1: +V, 3: 0 V, 2: Control output | D | E2E-X5ME2-M1 | E2E-X5MF2-M1 |
| M18 | 10 mm | | Pre-wired Models (2 m) | PVC (oil-resistant) | NO | --- | --- | E2E-X10ME1 2M *1 | E2E-X10MF1 2M |
| | | | | | NC | | | E2E-X10ME2 2M | E2E-X10MF2 2M |
| | | | M12 Connector Models | --- | NO | 1: +V, 3: 0 V, 4: Control output | B | E2E-X10ME1-M1 | E2E-X10MF1-M1 |
| | | | | | NC | 1: +V, 3: 0 V, 2: Control output | D | E2E-X10ME2-M1 | E2E-X10MF2-M1 |
| M30 | 18 mm | | Pre-wired Models (2 m) | PVC (oil-resistant) | NO | --- | --- | E2E-X18ME1 2M *1 | E2E-X18MF1 2M |
| | | | | | NC | | | E2E-X18ME2 2M | E2E-X18MF2 2M |
| | | | M12 Connector Models | --- | NO | 1: +V, 3: 0 V, 4: Control output | B | E2E-X18ME1-M1 | E2E-X18MF1-M1 |
| | | | | | NC | 1: +V, 3: 0 V, 2: Control output | D | E2E-X18ME2-M1 | E2E-X18MF2-M1 |

*1. Models with different frequencies are also available. The model number is E2E-X□M□□5 (example: E2E-X5ME15 2M).

*2. Refer to page 22 for details.

Ratings and Specifications

E2E-X□D□ DC 2-Wire Models

| Item | Size | | M8 | | M12 | | M18 | | M30 | |
|---|---|---|------------------------------|---|---|-------------------------|-------------------------|----------------------|---------------|-------------------------|
| | Shielded | Model | Shielded | Unshielded | Shielded | Unshielded | Shielded | Unshielded | Shielded | Unshielded |
| Item | Shielded | Model | E2E-X2D□ | E2E-X4MD□ | E2E-X3D□ | E2E-X8MD□ | E2E-X7D□ | E2E-X14MD□ | E2E-X10D□ | E2E-X20MD□ |
| Sensing distance | | | 2 mm ±10% | 4 mm ±10% | 3 mm ±10% | 8 mm ±10% | 7 mm ±10% | 14 mm ±10% | 10 mm ±10% | 20 mm ±10% |
| Set distance *1 | | | 0 to 1.6 mm | 0 to 3.2 mm | 0 to 2.4 mm | 0 to 6.4 mm | 0 to 5.6 mm | 0 to 11.2 mm | 0 to 8 mm | 0 to 16 mm |
| Differential travel | | | 15% max. of sensing distance | | 10% max. of sensing distance | | | | | |
| Detectable object | Ferrous metal (The sensing distance decreases with non-ferrous metal. Refer to <i>Engineering Data</i> on pages 16 and 17.) | | | | | | | | | |
| Standard sensing object | | | Iron, 8 × 8 × 1 mm | Iron, 20 × 20 × 1 mm | Iron, 12 × 12 × 1 mm | Iron, 30 × 30 × 1 mm | Iron, 18 × 18 × 1 mm | Iron, 30 × 30 × 1 mm | | Iron, 54 × 54 × 1 mm |
| Response frequency *2 | | | 1.5 kHz | 1 kHz | | 0.8 kHz | 0.5 kHz | 0.4 kHz | | 0.1 kHz |
| Power supply voltage (operating voltage range) | 12 to 24 VDC (10 to 30 VDC), ripple (p-p): 10% max. | | | | | | | | | |
| Leakage current | 0.8 mA max. | | | | | | | | | |
| Control output | Load current | 3 to 100 mA, Diagnostic output: 50 mA for -D1(5)S Models | | | | | | | | |
| | Residual voltage *3 | 3 V max. (Load current: 100 mA, Cable length: 2 m, M1J-T Models only: 5 V max.) | | | | | | | | |
| Indicators | D1 Models: Operation indicator (red) and setting indicator (green) D2 Models: Operation indicator (red) | | | | | | | | | |
| Operation mode (with sensing object approaching) | D1 Models: NO Refer to the timing charts under <i>I/O Circuit Diagrams</i> on page 19 for details. D2 Models: NC | | | | | | | | | |
| Diagnostic output delay | 0.3 to 1 s | | | | | | | | | |
| Protection circuits | Surge suppressor, Load short-circuit protection (for control and diagnostic output) | | | | | | | | | |
| Ambient temperature range | Operating: -25 to 70°C, Storage: -40 to 85°C (with no icing or condensation) | | | | | | | | | |
| Ambient humidity range | Operating/storage: 35% to 95% (with no condensation) | | | | | | | | | |
| Temperature influence | ±15% max. of sensing distance at 23°C in the temperature range of -25 to 70°C | | | ±10% max. of sensing distance at 23°C in the temperature range of -25 to 70°C | | | | | | |
| Voltage influence | ±1% max. of sensing distance at rated voltage in the rated voltage ±15% range | | | | | | | | | |
| Insulation resistance | 50 MΩ min. (at 500 VDC) between current-carrying parts and case | | | | | | | | | |
| Dielectric strength | 1000 VAC, 50/60 Hz for 1 minute between current carry parts and case | | | | | | | | | |
| Vibration resistance | Destruction: 10 to 55 Hz, 1.5-mm double amplitude for 2 hours each in X, Y, and Z directions | | | | | | | | | |
| Shock resistance | Destruction: 500 m/s ² 10 times each in X, Y, and Z directions | | | | Destruction: 1,000 m/s ² 10 times each in X, Y, and Z directions | | | | | |
| Degree of protection | Pre-wired Models: IEC 60529 IP67, in-house standards: oil-resistant Connector Models: IEC 60529 IP67 | | | | | | | | | |
| Connection method | Pre-wired Models (Standard cable length: 2 m), Connector Models, or Pre-wired Connector Models (Standard cable length: 0.3 m) | | | | | | | | | |
| Weight (packed state) | Pre-wired Models | Approx. 60 g | | | Approx. 70 g | | Approx. 130 g | | Approx. 175 g | |
| | Pre-wired Connector Models | --- | | | Approx. 40 g | | Approx. 70 g | | Approx. 110 g | |
| | Connector Models | Approx. 15 g | | | Approx. 25 g | | Approx. 40 g | | Approx. 90 g | |
| Materials | Case | Stainless steel (SUS303) | | | Nickel-plated brass | | | | | |
| | Sensing surface | PBT | | | | | | | | |
| | Clamping nuts | Nickel-plated brass | | | | | | | | |
| | Toothed washer | Zinc-plated iron | | | | | | | | |
| Accessories | Instruction manual | | | | | | | | | |

*1. Use the E2E within the range in which the setting indicator (green LED) is ON (except D2 Models).

*2. The response frequency is an average value.

Measurement conditions are as follows: standard sensing object, a distance of twice the standard sensing object, and a set distance of half the sensing distance.

*3. The residual voltage of each M1J-T Model is 5 V. When connecting to a device, make sure that the device can withstand the residual voltage. (Refer to page 26 for details.)

E2E-X□Y□ AC 2-Wire Models

| Item | Size | M8 | | M12 | | M18 | | M30 | |
|---|---------------------------------|--|----------------------|---------------------|--|----------------------|----------------------|---------------|----------------------|
| | Shielded Model | Shielded | Unshielded | Shielded | Unshielded | Shielded | Unshielded | Shielded | Unshielded |
| | | E2E-X1R5Y□ | E2E-X2MY□ | E2E-X2Y□ | E2E-X5MY□ | E2E-X5Y□ | E2E-X10MY□ | E2E-X10Y□ | E2E-X18MY□ |
| Sensing distance | | 1.5 mm ±10% | 2 mm ±10% | | 5 mm ±10% | | 10 mm ±10% | | 18 mm ±10% |
| Set distance | | 0 to 1.2 mm | 0 to 1.6 mm | | 0 to 4 mm | | 0 to 8 mm | | 0 to 14 mm |
| Differential travel | | 10% max. of sensing distance | | | | | | | |
| Detectable object | | Ferrous metal (The sensing distance decreases with non-ferrous metal. Refer to <i>Engineering Data</i> on page 17.) | | | | | | | |
| Standard sensing object | | Iron, 8 × 8 × 1 mm | Iron, 12 × 12 × 1 mm | | Iron, 15 × 15 × 1 mm | Iron, 18 × 18 × 1 mm | Iron, 30 × 30 × 1 mm | | Iron, 54 × 54 × 1 mm |
| Response frequency | | 25 Hz | | | | | | | |
| Power supply voltage (operating voltage range)¹ | | 24 to 240 VAC (20 to 264 VAC), 50/60 Hz | | | | | | | |
| Leakage current | | 1.7 mA max. | | | | | | | |
| Control output | Load current² | 5 to 100 mA | | 5 to 200 mA | | 5 to 300 mA | | | |
| | Residual voltage | Refer to <i>Engineering Data</i> on page 18. | | | | | | | |
| Indicators | | Operation indicator (red) | | | | | | | |
| Operation mode (with sensing object approaching) | | Y1 Models: NO Y2 Models: NC Refer to the timing charts under <i>I/O Circuit Diagrams</i> on page 21 for details. | | | | | | | |
| Protection circuits | | Surge suppressor | | | | | | | |
| Ambient temperature range^{*1,2} | | Operating/Storage: -25 to 70°C (with no icing or condensation) | | | Operating/Storage: -40 to 85°C (with no icing or condensation) | | | | |
| Ambient humidity range | | Operating/storage: 35% to 95% (with no condensation) | | | | | | | |
| Temperature influence | | ±10% max. of sensing distance at 23°C in the temperature range of -25 to 70°C | | | ±15% max. of sensing distance at 23°C in the temperature range of -40 to 85°C, ±10% max. of sensing distance at 23°C in the temperature range of -25 to 70°C | | | | |
| Voltage influence | | ±1% max. of sensing distance at rated voltage in the rated voltage ±15% range | | | | | | | |
| Insulation resistance | | 50 MΩ min. (at 500 VDC) between current-carrying parts and case | | | | | | | |
| Dielectric strength | | 4,000 VAC (M8 Models: 2,000 VAC), 50/60 Hz for 1 min between current-carrying parts and case | | | | | | | |
| Vibration resistance | | Destruction: 10 to 55 Hz, 1.5-mm double amplitude for 2 hours each in X, Y, and Z directions | | | | | | | |
| Shock resistance | | Destruction: 500 m/s ² 10 times each in X, Y, and Z directions | | | Destruction: 1,000 m/s ² 10 times each in X, Y, and Z directions | | | | |
| Degree of protection | | Pre-wired Models: IEC 60529 IP67, in-house standards: oil-resistant Connector Models: IEC 60529 IP67 | | | | | | | |
| Connection method | | Pre-wired Models (Standard cable length: 2 m) and Connector Models | | | | | | | |
| Weight (packed state) | Pre-wired Models Model | Approx. 60 g | | Approx. 70 g | | Approx. 130 g | | Approx. 175 g | |
| | Connector Models | Approx. 15 g | | Approx. 25 g | | Approx. 40 g | | Approx. 90 g | |
| Materials | Case | Stainless steel (SUS303) | | Nickel-plated brass | | | | | |
| | Sensing surface | PBT | | | | | | | |
| | Clamping nuts | Nickel-plated brass | | | | | | | |
| | Toothed washer | Zinc-plated iron | | | | | | | |
| Accessories | | Instruction manual | | | | | | | |

*1. When supplying 24 VAC to any of the above models, make sure that the operating ambient temperature range is at least -25°C.

*2. When using an M18 or M30 Connector Model at an ambient temperature between 70 and 85°C, make sure that the Sensor has a control output (load current) of 5 to 200 mA max.

E2E-X□T1 AC/DC 2-Wire Models

| Item | Size Shielded Model | M12 | M18 | M30 |
|--|---------------------------|---|----------------------|----------------------|
| | | Shielded | | |
| | | E2E-X3T1 | E2E-X7T1 | E2E-X10T1 |
| Sensing distance | | 3 mm ±10% | 7 mm ±10% | 10 mm ±10% |
| Set distance | | 0 to 2.4 mm | 0 to 5.6 mm | 0 to 8 mm |
| Differential travel | | 10% max. of sensing distance | | |
| Detectable object | | Ferrous metal (The sensing distance decreases with non-ferrous metal. Refer to <i>Engineering Data</i> on page 16.) | | |
| Standard sensing object | | Iron, 12 × 12 × 1 mm | Iron, 18 × 18 × 1 mm | Iron, 30 × 30 × 1 mm |
| Response frequency *1 | DC | 1 kHz | 0.5 kHz | 0.4 kHz |
| | AC | 25 Hz | | |
| Power supply voltage (operating voltage range) *2 | | 24 to 240 VDC (20 to 264 VDC) 48 to 240 VAC (40 to 264 VAC) | | |
| Leakage current | | DC: 1 mA max. AC: 2 mA max. | | |
| Control output | Load current | 5 to 100 mA | | |
| | Residual voltage | DC: 6 V max. (Load current: 100 mA, Cable length: 2 m) AC: 10 V max. (Load current: 5 mA, Cable length: 2 m) | | |
| Indicators | | Operation indicator (red), Setting indicator (green) | | |
| Operation mode (with sensing object approaching) | | NO (Refer to the timing charts under <i>I/O Circuit Diagrams</i> on page 21 for details.) | | |
| Protection circuits | | Load short-circuit protection (20 to 40 VDC only), Surge suppressor | | |
| Ambient temperature range | | Operating: -25 to 70°C, Storage: -40 to 85°C (with no icing or condensation) | | |
| Ambient humidity range | | Operating/Storage: 35% to 95% (with no condensation) | | |
| Temperature influence | | ±10% max. of sensing distance at 23°C in the temperature range of -25 to 70°C | | |
| Voltage influence | | ±1% max. of sensing distance at rated voltage in the rated voltage ±15% range | | |
| Insulation resistance | | 50 MΩ min. (at 500 VDC) between current-carrying parts and case | | |
| Dielectric strength | | 4,000 VAC, 50/60 Hz for 1 minute between current-carrying parts and case | | |
| Vibration resistance | | Destruction: 10 to 55 Hz, 1.5-mm double amplitude for 2 hours each in X, Y, and Z directions | | |
| Shock resistance | | Destruction: 1,000 m/s ² 10 times each in X, Y, and Z directions | | |
| Degree of protection | | IEC 60529 IP67, in-house standards: oil-resistant | | |
| Connection method | | Pre-wired Models (Standard cable length: 2 m) | | |
| Weight (packed state) | | Approx. 80 g | Approx. 140 g | Approx. 190 g |
| Materials | Case | Nickel-plated brass | | |
| | Sensing surface | PBT | | |
| | Clamping nuts | Nickel-plated brass | | |
| | Toothed washer | Zinc-plated iron | | |
| Accessories | | Instruction manual | | |

*1. The response frequency is an average value. Measurement conditions are as follows: standard sensing object, a distance of twice the standard sensing object, and a set distance of half the sensing distance.

*2. Power Supply Voltage Waveform:

Use a sine wave for the power supply. Using a rectangular AC power supply may result in faulty reset.

E2E-X□E□/F□ DC 3-Wire Models

| Item | Size Shielded Model | M8 | | M12 | | M18 | | M30 | |
|--|---------------------------|--|----------------------|---------------------|---|-------------------------|----------------------|------------------|-------------------------|
| | | Shielded | Unshielded | Shielded | Unshielded | Shielded | Unshielded | Shielded | Unshielded |
| | | E2E -X1R5E□/F□ | E2E -X2ME□/F□ | E2E -X2E□/F□ | E2E -X5ME□/F□ | E2E -X5E□/F□ | E2E -X10ME□/F□ | E2E-X10E□/ F□ | E2E -X18ME□/F□ |
| Sensing distance | | 1.5 mm ±10% | 2 mm ±10% | | 5 mm ±10% | | 10 mm ±10% | | 18 mm ±10% |
| Set distance | | 0 to 1.2 mm | 0 to 1.6 mm | | 0 to 4 mm | | 0 to 8 mm | | 0 to 14 mm |
| Differential travel | | 10% max. of sensing distance | | | | | | | |
| Detectable object | | Ferrous metal (The sensing distance decreases with non-ferrous metal. Refer to <i>Engineering Data</i> on pages 16 and 17.) | | | | | | | |
| Standard sensing object | | Iron, 8 × 8 × 1 mm | Iron, 12 × 12 × 1 mm | | Iron, 15 × 15 × 1 mm | Iron, 18 × 18 × 1 mm | Iron, 30 × 30 × 1 mm | | Iron, 54 × 54 × 1 mm |
| Response frequency *1 | | 2 kHz | 0.8 kHz | 1.5 kHz | 0.4 kHz | 0.6 kHz | 0.2 kHz | 0.4 kHz | 0.1 kHz |
| Power supply voltage (operating voltage range) *2 | | 12 to 24 VDC (10 to 40 VDC), ripple (p-p): 10% max. | | | | | | | |
| Current consumption | | 13 mA max. | | | | | | | |
| Control output | Load current *2 | 200 mA max. | | | | | | | |
| | Residual voltage | 2 V max. (Load current: 200 mA, Cable length: 2 m) | | | | | | | |
| Indicators | | Operation indicator (red) | | | | | | | |
| Operation mode (with sensing object approaching) | | E1/F1 Models: NO E2/F2 Models: NC Refer to the timing charts under <i>/O Circuit Diagrams</i> on page 20 for details. | | | | | | | |
| Protection circuits | | Load short-circuit protection, Surge suppressor, Reverse polarity protection | | | | | | | |
| Ambient temperature range *2 | | Operating/Storage: -40 to 85°C (with no icing or condensation) | | | | | | | |
| Ambient humidity range | | Operating/Storage: 35% to 95% (with no condensation) | | | | | | | |
| Temperature influence | | ±15% max. of sensing distance at 23°C in the temperature range of -40 to 85°C ±10% max. of sensing distance at 23°C in the temperature range of -25 to 70°C | | | | | | | |
| Voltage influence | | ±1% max. of sensing distance at rated voltage in the rated voltage ±15% range | | | | | | | |
| Insulation resistance | | 50 MΩ min. (at 500 VDC) between current-carrying parts and case | | | | | | | |
| Dielectric strength | | 1,000 VAC, 50/60 Hz for 1 minute between current carry parts and case | | | | | | | |
| Vibration resistance | | Destruction: 10 to 55 Hz, 1.5-mm double amplitude for 2 hours each in X, Y, and Z directions | | | | | | | |
| Shock resistance | | Destruction: 500 m/s ² 10 times each in X, Y, and Z directions | | | Destruction: 1,000 m/s ² 10 times each in X, Y, and Z directions | | | | |
| Degree of protection | | Pre-wired Models : IEC 60529 IP67, in-house standards: oil-resistant Connector Models : IEC 60529 IP67 | | | | | | | |
| Connection method | | Pre-wired Models (Standard cable length: 2 m) and Connector Models | | | | | | | |
| Weight (packed state) | Pre-wired Models | Approx. 65 g | | Approx. 75 g | | Approx. 150 g | | Approx. 195 g | |
| | Connector Models | Approx. 15 g | | Approx. 25 g | | Approx. 40 g | | Approx. 90 g | |
| Materials | Case | Stainless steel (SUS303) | | Nickel-plated brass | | | | | |
| | Sensing surface | PBT | | | | | | | |
| | Clamping nuts | Nickel-plated brass | | | | | | | |
| | Toothed washer | Zinc-plated iron | | | | | | | |
| Accessories | | Instruction manual | | | | | | | |

*1. The response frequency is an average value. Measurement conditions are as follows: standard sensing object, a distance of twice the standard sensing object, and a set distance of half the sensing distance.

*2. When using an M8 Model at an ambient temperature between 70 and 85°C, supply 10 to 30 VDC to the Sensor and make sure that the Sensor has a control output of 100 mA maximum.

E2E-C□C/B□ and E2E-X1C/B□ DC 3-Wire Models

| Item | Size | 3 dia. | 4 dia. | M5 | 5.4 dia. |
|---|-------------------------|---|--|-------------|------------|
| | Shielded Model | Shielded | | | |
| | | E2E-CR6C/B□ | E2E-CR8C/B□ | E2E-X1C/B□ | E2E-C1C/B□ |
| Sensing distance | | 0.6 mm ±15% | 0.8 mm ±15% | 1 mm ±15% | |
| Set distance | | 0 to 0.4 mm | 0 to 0.5 mm | 0 to 0.7 mm | |
| Differential travel | | 15% max. of sensing distance | | | |
| Detectable object | | Ferrous metal (The sensing distance decreases with non-ferrous metal. Refer to <i>Engineering Data</i> on pages 17 and 18.) | | | |
| Standard sensing object | | Iron, 3 × 3 × 1 mm | Iron, 5 × 5 × 1 mm | | |
| Response frequency * | | 2 kHz | 3 kHz | | |
| Power supply voltage (operating voltage range) | | 12 to 24 VDC (10 to 30 VDC), ripple (p-p): 10% max. | | | |
| Current consumption | | 10 mA max. | 17 mA max. | | |
| Control output | Load current | Open-collector output, 80 mA max. (30 VDC max.) | Open-collector output, 100 mA max. (30 VDC max.) | | |
| | Residual voltage | 1 V max. (Load current: 80 mA, Cable length: 2 m) | 2 V max. (Load current: 100 mA, Cable length: 2 m) | | |
| Indicators | | Operation indicator (red) | | | |
| Operation mode (with sensing object approaching) | | C1/B1 Models: NO C2 Models: NC | Refer to the timing charts under <i>I/O Circuit Diagrams</i> on page 20 for details. | | |
| Protection circuits | | Reverse polarity protection, Surge suppressor | | | |
| Ambient temperature range | | Operating/Storage: -25 to 70°C (with no icing or condensation) | | | |
| Ambient humidity range | | Operating/Storage: 35% to 95% (with no condensation) | | | |
| Temperature influence | | ±15% max. of sensing distance at 23°C in the temperature range of -25 to 70°C | | | |
| Voltage influence | | ±5% max. of sensing distance at rated voltage in the rated voltage ±10% range | ±2.5% max. of sensing distance at rated voltage in the rated voltage ±15% range | | |
| Insulation resistance | | 50 MΩ min. (at 500 VDC) between current-carrying parts and case | | | |
| Dielectric strength | | 500 VAC, 50/60 Hz for 1 min between current-carrying parts and case | | | |
| Vibration resistance | | Destruction: 10 to 55 Hz, 1.5-mm double amplitude for 2 hours each in X, Y, and Z directions | | | |
| Shock resistance | | Destruction: 500 m/s ² 10 times each in X, Y, and Z directions | | | |
| Degree of protection | | IEC 60529 IP66 | IEC 60529 IP67, in-house standards: oil-resistant | | |
| Connection method | | Pre-wired Models (Standard cable length: 2 m) | | | |
| Weight (packed state) | | Approx. 60 g | | | |
| Materials | Case | Stainless steel (SUS303) | Nickel-plated brass | | |
| | Sensing surface | Heat-resistant ABS | | | |
| | Clamping nuts | Nickel-plated brass (E2E-X1C/B□ only) | | | |
| | Toothed washer | Zinc-plated iron (E2E-X1C/B□ only) | | | |
| Accessories | | Instruction manual | | | |

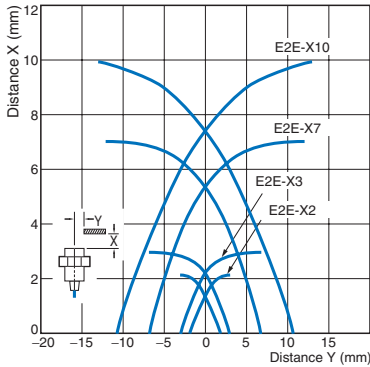
* The response frequency is an average value. Measurement conditions are as follows: standard sensing object, a distance of twice the standard sensing object, and a set distance of half the sensing distance.

Engineering Data (Reference Value)

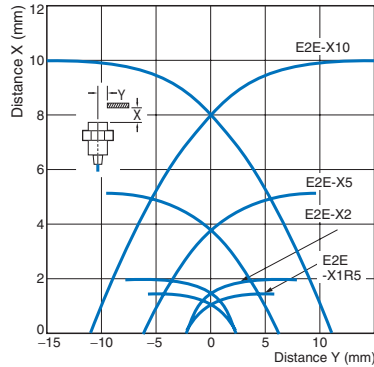
Sensing Area

Shielded Models

E2E-X□D□/-X□T1

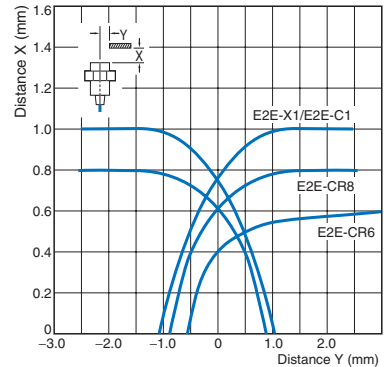


E2E-X□E□/-X□Y□/-X□F□



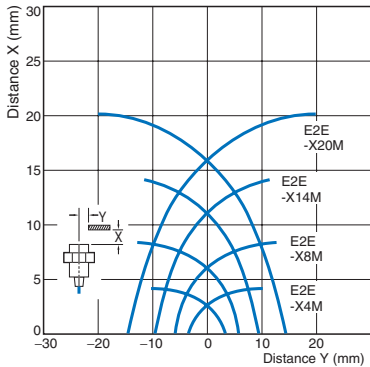
E2E-C□C□/-X□C□

E2E-C□B1/-X□B□

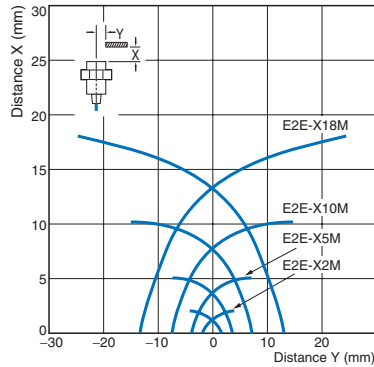


Unshielded Models

E2E-X□MD□

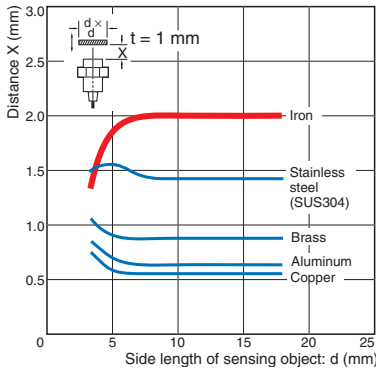


E2E-X□ME□/-X□MY□/-X□MF□

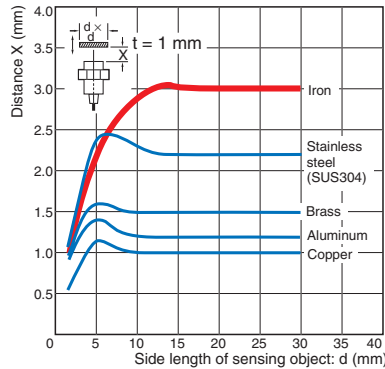


Influence of Sensing Object Size and Material

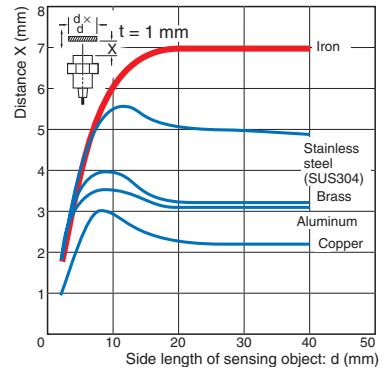
E2E-X2D□



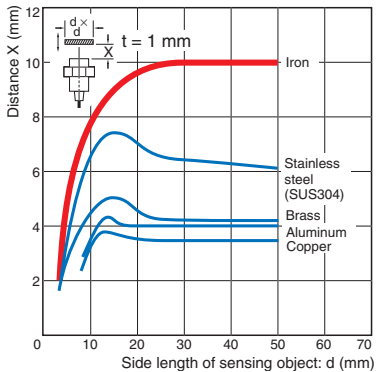
E2E-X3D□/-X3T1



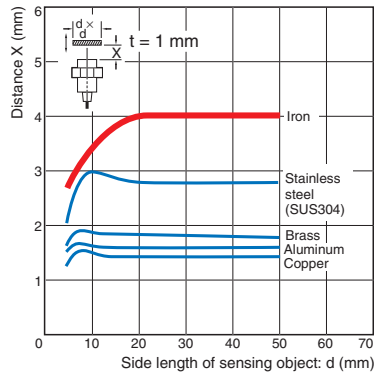
E2E-X7D□/-X7T1



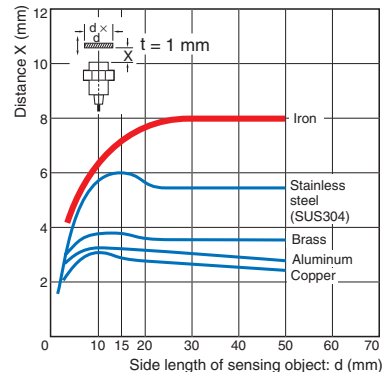
E2E-X10D□/-X10T1



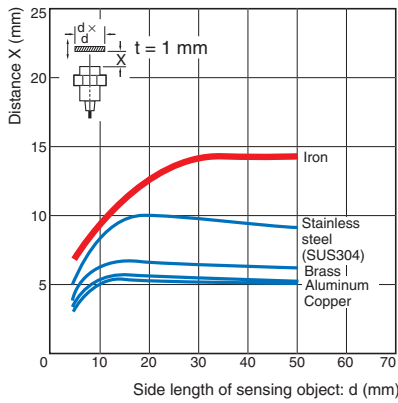
E2E-X4MD□



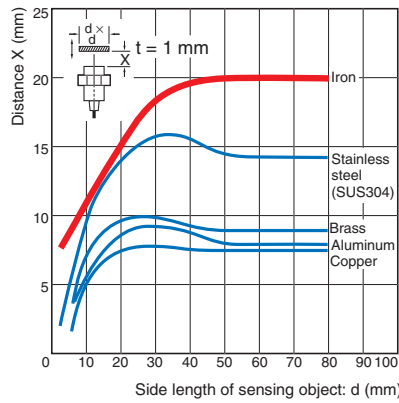
E2E-X8MD□



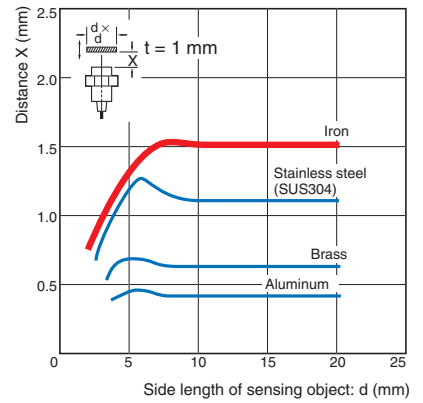
E2E-X14MD



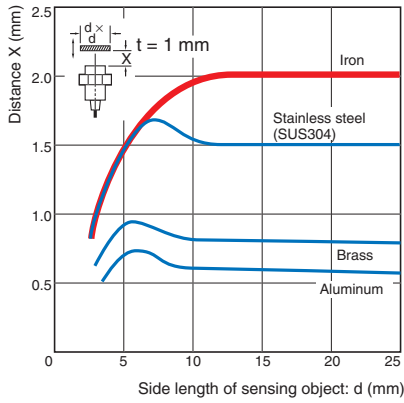
E2E-X20MD



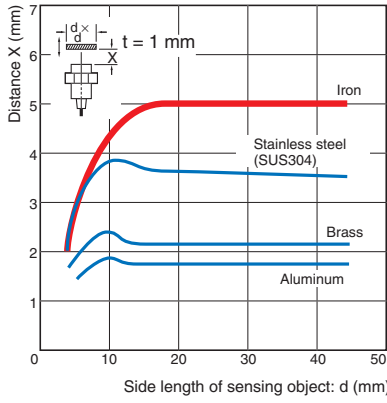
E2E-X1R5E/-X1R5Y/-X1R5F



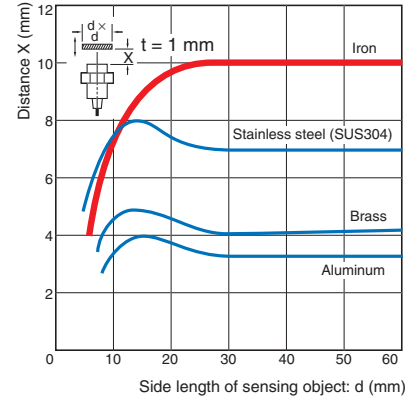
E2E-X2E/-X2Y/-X2F



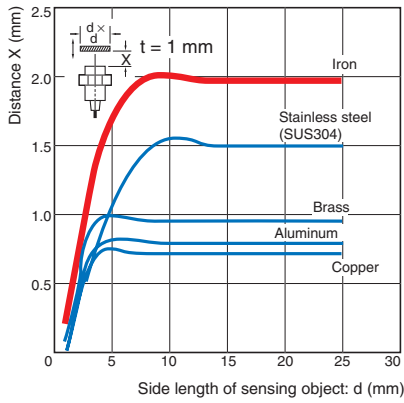
E2E-X5E/-X5Y/-X5F



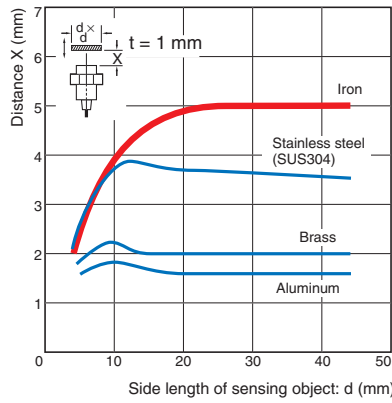
E2E-X10E/-X10Y/-X10F



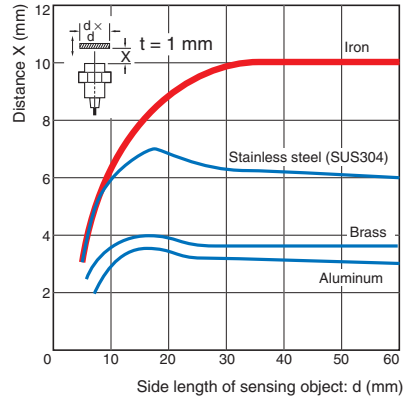
E2E-X2ME/-X2MY/-X2MF



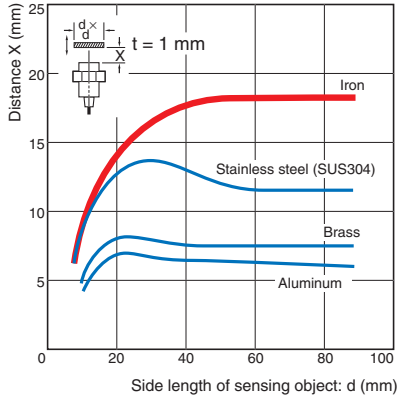
E2E-X5ME/-X5MY/-X5MF



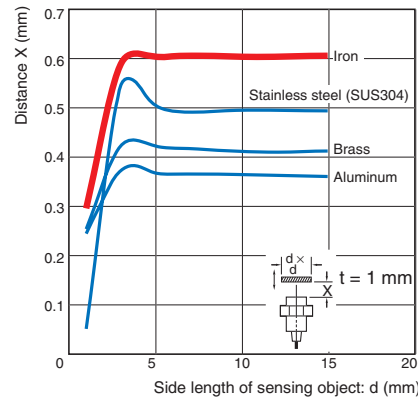
E2E-X10ME/-X10MY/-X10MF



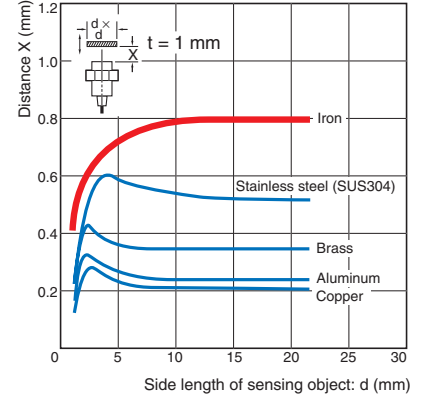
E2E-X18ME/-X18MY/-X18MF



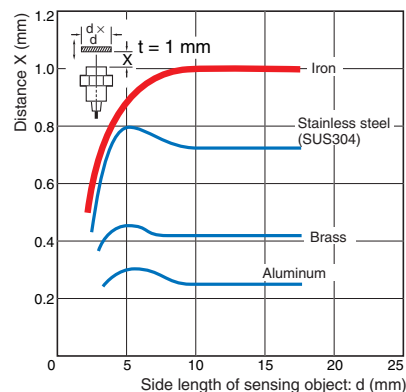
E2E-CR6



E2E-CR8

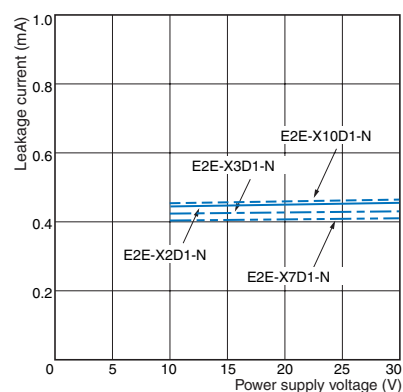


E2E-X1□/C1□

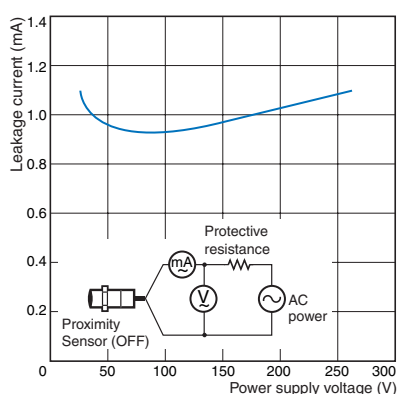


Leakage Current

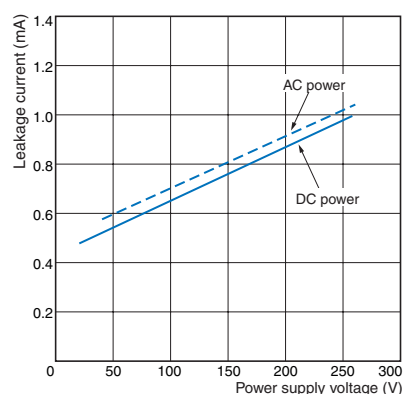
E2E-X□D□



E2E-X□Y□

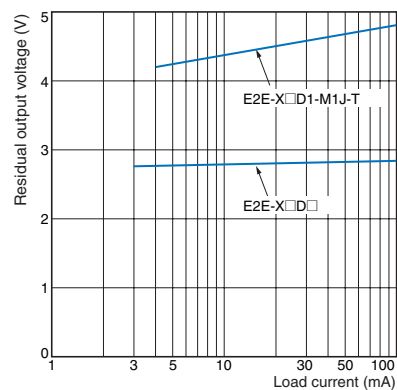


E2E-X□T1

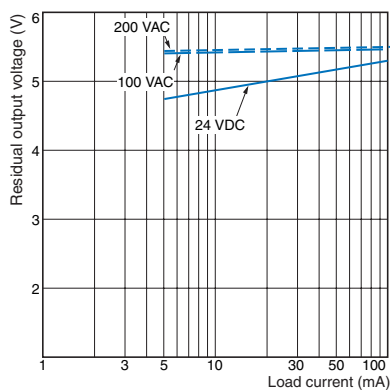


Residual Output Voltage

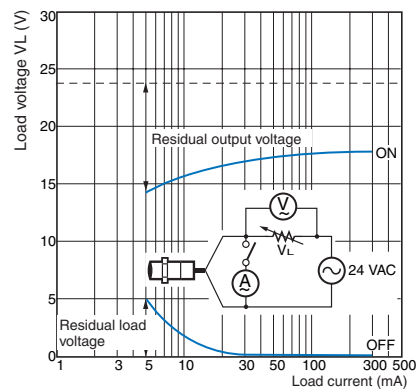
E2E-X□D□



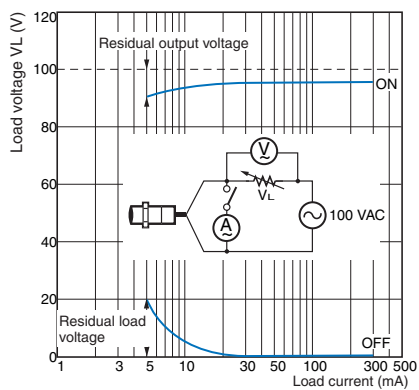
E2E-X□T1



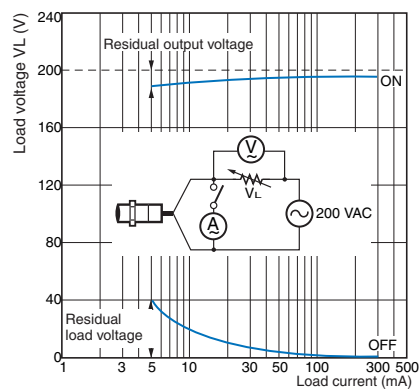
E2E-X□Y□ at 24 VAC



E2E-X□Y□ at 100 VAC



E2E-X□Y□ at 200 VAC



I/O Circuit Diagrams

E2E-X□D□ DC 2-Wire Models

| Operation mode | Model | Timing Chart | Output circuit |
|--|---|--|--|
| <p>Without self-diagnostic output: NO</p> | <p>E2E-X□D1-N E2E-X□D1-M1G(J) E2E-X□D1-(M1TGJ)-U E2E-X□D1-M3G</p> | | <p>Polarity: Yes</p> <p>Note: The load can be connected to either the +V or 0 V side.</p> |
| | <p>E2E-X□D1-M1J-T</p> | | <p>Polarity: None</p> <p>Note 1. The load can be connected to either the +V or 0 V side. 2. The E2E-X□D1-M1J-T has no polarity. Therefore, terminals 3 and 4 have no polarity.</p> |
| <p>Without self-diagnostic output: NC</p> | <p>E2E-X□D2-N E2E-X□D2-M1G E2E-X□D2-(M1TGJ)-U E2E-X□D2-M3G</p> | | <p>Note: The load can be connected to either the +V or 0 V side.</p> |
| <p>With self-diagnostic output: NO</p> | <p>E2E-X□D1S E2E-X□D1S-M1</p> | <p>* The diagnostic output is ON when there is a coil burnout or the sensing object is located in the unstable sensing area for 0.3 s or longer.</p> | <p>Note: Connect both the loads to the +V side of the control output and diagnostic output.</p> |

DC 3-Wire Models

| Operation mode | Output specifications | Model | Timing Chart | Output circuit |
|----------------|---------------------------|--|---|---|
| NO | NPN output | E2E-X□E□ E2E-X□E□-M1 E2E-X□E□-M3 | Sensing object Present Not present Operation indicator (red) ON OFF Control output (between brown and black leads) ON OFF Output voltage (between black and blue leads) High Low | <p>*Constant current output is 1.5 to 3 mA. Note: For Connector Models, the connection between pins 1, 4 and 3 uses an NO contact, and the connection between pins 1, 2 and 3 uses an NC contact.</p> |
| NC | | | Sensing object Present Not present Operation indicator (red) ON OFF Control output (between brown and black leads) ON OFF Output voltage (between black and blue leads) High Low | |
| NO | PNP output | E2E-X□F□ E2E-X□F□-M1 E2E-X□F□-M3 | Sensing object Present Not present Operation indicator (red) ON OFF Control output (Between blue and black leads) ON OFF Output voltage (between brown and black leads) High Low | <p>*When a transistor is connected Note: For Connector Models, the connection between pins 1, 4 and 3 uses an NO contact, and the connection between pins 1, 2 and 3 uses an NC contact.</p> |
| NC | | | Sensing object Present Not present Operation indicator (red) ON OFF Control output (Between blue and black leads) ON OFF Output voltage (between brown and black leads) High Low | |
| NO | NPN open-collector output | E2E-C/X□C□ | Sensing object Present Not present Operation indicator (red) ON OFF Control output ON OFF | <p>*The E2E-CR6□ does not have 100-Ω resistance.</p> |
| NC | | | Sensing object Present Not present Operation indicator (red) ON OFF Control output ON OFF | |
| NO | PNP open-collector output | E2E-C/X□B□ | Sensing object Present Not present Operation indicator (red) ON OFF Control output ON OFF | <p>*The E2E-CR6□ does not have 100-Ω resistance.</p> |
| NC | | | Sensing object Present Not present Operation indicator (red) ON OFF Control output ON OFF | |

AC 2-Wire Models

| Operation mode | Model | Timing Chart | Output circuit |
|----------------|-------------------------|--------------|--|
| NO | E2E-X□Y□ E2E-X□Y□-M1 | | <p>Note: For Connector Models, the connection between pins 3 and 4 uses an NO contact, and the connection between pins 1 and 2 uses an NC contact.</p> |
| NC | | | |

AC/DC 2-Wire Models

| Operation mode | Model | Timing Chart | Output circuit |
|----------------|----------|--------------|--|
| NO | E2E-X□T1 | | <p>Note: The load can be connected to either the +V or 0 V side. There is no need to be concerned about the polarity (brown/blue) of the Proximity Sensor.</p> |

Sensor I/O Connectors (Sockets on One Cable End)

Model for Connectors and Pre-wired Connectors: A Connector is not provided with the Sensor. Be sure to order a Connector separately.

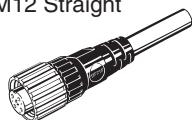
[Refer to Dimensions for the XS2, XS3, and XS5.]

| Applicable connector code | Connector | | | | Applicable Proximity Sensor model number | Connection diagram No. *2 |
|---------------------------|-----------|--|----------------------------|----------------------------|--|---------------------------|
| | Screw | Appearance *1 | Cable length 2m | Cable length 5m | | |
| | | | CablConnector model number | CablConnector model number | | |
| A | M12 | Straight | XS2F-D421-DA0-F | XS2F-D421-GA0-F | E2E-X□D1-M1G(J) | 1 |
| | | L-shape | XS2F-D422-DA0-F | XS2F-D422-GA0-F | | |
| B | M12 | Straight | XS2F-D421-DC0-F | XS2F-D421-GC0-F | E2E-X□E1-M1 E2E-X□F1-M1 | 10 |
| | | L-shape | XS2F-D422-DC0-F | XS2F-D422-GC0-F | | |
| C | M12 | Straight | XS2F-D421-DD0 | XS2F-D421-GD0 | E2E-X□D1-M1J-T | 3 |
| | | | E2E-X□D1-M1 | 2 | | |
| | | L-shape | XS2F-D422-DD0 | XS2F-D422-GD0 | E2E-X□D1-M1J-T | 3 |
| | | | E2E-X□D1-M1 | 2 | | |
| D | M12 | Straight | XS2F-D421-D80-F | XS2F-D421-G80-F | E2E-X□D2-M1G(J) | 6 |
| | | | | | E2E-X□D2-M1J-T | 8 |
| | | | | | E2E-X□D2-M1 | 7 |
| | | | | | E2E-X□D1S-M1 | 5 |
| | | | | | E2E-X□E2-M1 E2E-X□F2-M1 | 11 |
| | | | | | E2E-X□D2-M1G(J) | 6 |
| | | L-shape | XS2F-D422-D80-F | XS2F-D422-G80-F | E2E-X□D2-M1J-T | 8 |
| | | | | | E2E-X□D2-M1 | 7 |
| | | | | | E2E-X□D1S-M1 | 5 |
| | | | | | E2E-X□E2-M1 E2E-X□F2-M1 | 11 |
| | | | | | E2E-X□D2-M1G(J) | 6 |
| | | | | | E2E-X□D2-M1J-T | 8 |
| E | M12 | Straight | XS2F-A421-DB0-F | XS2F-A421-GB0-F | E2E-X□Y1-M1 | 14 |
| | | L-shape | XS2F-A422-DB0-F | XS2F-A422-GB0-F | | |
| F | M12 | Straight | XS2F-A421-D90-F | XS2F-A421-G90-F | E2E-X□Y2-M1 | 15 |
| G | M12 | Smartclick Connector, Straight | XS5F-D421-D80-F | XS5F-D421-G80-F | E2E-X□D1-M1TGJ | 16 |
| H | M12 | Smartclick Connector, Straight Oil-resistant Reinforced Cables | XS5F-D421-D80-P | XS5F-D421-G80-P | E2E-X□D1-M1TGJ-U | 17 |
| | | | | | E2E-X□D2-M1TGJ-U | 18 |
| I | M8 | Straight | XS3F-M421-402-A | XS3F-M421-405-A | E2E-X□D1-M3G | 4 |
| | | | | | E2E-X□D2-M3G | 9 |
| | | | | | E2E-X□E1-M3 E2E-X□F1-M3 | 12 |
| | | | | | E2E-X□E2-M3 E2E-X□F2-M3 | 13 |
| | | | | | E2E-X□D1-M3G | 4 |
| | | | | | E2E-X□D2-M3G | 9 |
| | | L-shape | XS3F-M422-402-A | XS3F-M422-405-A | E2E-X□E1-M3 E2E-X□F1-M3 | 12 |
| | | | | | E2E-X□E2-M3 E2E-X□F2-M3 | 13 |

Note: Refer to *Introduction to Sensor I/O Connectors/Sensor Controllers* for details and for information on Cable length and Robotics Cables.

*1. Images of straight and L-shaped connectors.

M12 Straight



M12 L-shape



M8 Straight



M8 L-shape



*2. Refer to *Connection Diagrams* on page 23 for information on Proximity Sensor and I/O Connector connections.

Connections for Sensor I/O Connectors

| Connection diagram No. | Proximity Sensor | | | Sensor I/O Connector model number | Connections |
|------------------------|---------------------------------|----------------|-------------------|--|-------------|
| | Type | Operation mode | Model | | |
| 1 | DC 2-wire (IEC pin wiring) | NO | E2E-X□D1-M1G/M1GJ | XS2F-D42□□A0-F 1: Straight 2: L-shape D: 2-m cable G: 5-m cable | |
| 2 | DC 2-wire (previous pin wiring) | | E2E-X□D1-M1 | XS2F-D42□□D0 1: Straight 2: L-shape D: 2-m cable G: 5-m cable | |
| 3 | DC 2-wire (no polarity) | | E2E-X□D1-M1J-T | XS2F-D42□□D0 1: Straight 2: L-shape D: 2-m cable G: 5-m cable | |
| 4 | DC 2-wire (M8 connector) | | E2E-X□D1-M3G | XS3F-M42□□40□-A 1: Straight 2: L-shape 2: 2-m cable 5: 5-m cable | |
| 5 | DC 2-wire (diagnostic type) | | E2E-X□D1S-M1 | XS2F-D42□□80-F 1: Straight 2: L-shape D: 2-m cable G: 5-m cable | |
| 6 | DC 2-wire (IEC pin wiring) | NC | E2E-X□D2-M1G/M1GJ | XS2F-D42□□80-F 1: Straight 2: L-shape D: 2-m cable G: 5-m cable | |
| 7 | DC 2-wire (previous pin wiring) | | E2E-X□D2-M1 | XS2F-D42□□80-F 1: Straight 2: L-shape D: 2-m cable G: 5-m cable | |
| 8 | DC 2-wire (no polarity) | | E2E-X□D2-M1J-T | XS2F-D42□□80-F 1: Straight 2: L-shape D: 2-m cable G: 5-m cable | |
| 9 | DC 2-wire (M8 connector) | | E2E-X□D2-M3G | XS3F-M42□□40□-A 1: Straight 2: L-shape 2: 2-m cable 5: 5-m cable | |

* Different from Proximity Sensor wire colors.

| Connection diagram No. | Proximity Sensor | | | Sensor I/O Connector model number | Connections |
|------------------------|----------------------------------|----------------|------------------|---|--|
| | Type | Operation mode | Model | | |
| 10 | DC 3-wire | NO | E2E-X□E/F1-M1 | XS2F-D42□-□C0-F 1: Straight 2: L-shape D: 2-m cable G: 5-m cable | |
| 11 | | NC | E2E-X□E2/F2-M1 | XS2F-D42□-□80-F 1: Straight 2: L-shape D: 2-m cable G: 5-m cable | |
| 12 | DC 3-wire (M8 connector) | NO | E2E-X□E1/F1-M3 | XS3F-M42□-□40□-A 1: Straight 2: L-shape 2: 2-m cable 5: 5-m cable | |
| 13 | | NC | E2E-X□E2/F2-M3 | XS3F-M42□-□40□-A 1: Straight 2: L-shape 2: 2-m cable 5: 5-m cable | |
| 14 | AC 2-wire | NO | E2E-X□Y1-M1 | XS2F-A42□-□B0-F 1: Straight 2: L-shape D: 2-m cable G: 5-m cable | |
| 15 | | NC | E2E-X□Y2-M1 | XS2F-A421□-□90-F D: 2-m cable G: 5-m cable | |
| 16 | DC 2-wire (Smartclick connector) | NO | E2E-X□D1-M1TGJ | XS5F-D421□-□80-F D: 2-m cable G: 5-m cable | |
| 17 | | | E2E-X□D1-M1TGJ-U | XS5F-D421□-□80-P D: 2-m cable G: 5-m cable | |
| 18 | | | NC | E2E-X□D2-M1TGJ-U | XS5F-D421□-□80-P D: 2-m cable G: 5-m cable |

* Different from Proximity Sensor wire colors.

Refer to Introduction to Sensor I/O Connectors/Sensor Controllers for details.

Safety Precautions

Refer to *Warranty and Limitations of Liability*.

⚠ WARNING

This product is not designed or rated for ensuring safety of persons either directly or indirectly. Do not use it for such purposes.



⚠ CAUTION

- Do not short the load. Explosion or burning may result.
- Do not supply power to the Sensor with no load, otherwise Sensor may be damaged.



Applicable Models

E2E-CR6□
E2E-CR8□
E2E-X1□
E2E-C1□

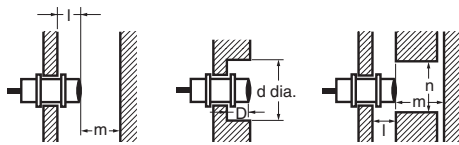
Precautions for Correct Use

Do not use this product under ambient conditions that exceed the ratings.

● Design

Influence of Surrounding Metal

When mounting the Sensor within a metal panel, ensure that the clearances given in the following table are maintained. Failure to maintain these distances may cause deterioration in the performance of the Sensor.



Influence of Surrounding Metal

(Unit: mm)

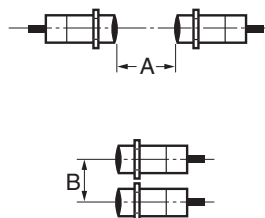
| Model | Item | M8 | M12 | M18 | M30 | |
|--|--|---------------------------------|------------|--------|--------|-----|
| DC 2-Wire Models E2E-X□D□ | Shielded | l | 0 | | | |
| | | d | 8 | 12 | 18 | 30 |
| | | D | 0 | | | |
| | | m | 4.5 | 8 | 20 | 40 |
| | | n | 12 | 18 | 27 | 45 |
| | | AC/DC 2-Wire Models E2E-X□T1 | Unshielded | l | 12 | 15 |
| d | 24 | | | 40 | 70 | 90 |
| D | 12 | | | 15 | 22 | 30 |
| m | 8 | | | 20 | 40 | 70 |
| n | 24 | | | 40 | 70 | 90 |
| DC 3-Wire Models E2E-X□E□ E2E-X□F□ AC 2-Wire Models E2E-X□Y□ | Shielded | | | l | 0 | |
| | | d | 8 | 12 | 18 | 30 |
| | | D | 0 | | | |
| | | m | 4.5 | 8 | 20 | 40 |
| | | n | 12 | 18 | 27 | 45 |
| | | Unshielded | l | 6 | 15 | 22 |
| | d | | 24 | 40 | 55 | 90 |
| | D | | 6 | 15 | 22 | 30 |
| | m | | 8 | 20 | 40 | 70 |
| | n | | 24 | 36 | 54 | 90 |
| | Model | | Item | 3 dia. | 4 dia. | M5 |
| | DC 3-Wire Models E2E-X□C/B□ E2E-C□C/B□ | Shielded | l | 0 | | |
| d | | | 3 | 4 | 5 | 5.4 |
| D | | | 0 | | | |
| m | | | 2 | 2.4 | 3 | |
| n | | | 6 | | 8 | |

Relationship between Sizes and Models

| Model | Model |
|----------|---|
| 3 dia. | E2E-CR6C/B |
| | E2E-CR8C□ E2E-CR8B□ |
| 4 dia. | E2E-X1C□ E2E-X1B□ |
| | E2E-C1C□ E2E-C1B□ |
| M5 | E2E-X2D□ E2E-X1R5E□ E2E-X1R5F□ E2E-X1R5Y□ |
| | E2E-X4MD□ E2E-X2ME□ E2E-X2MF□ E2E-X2MY□ |
| 5.4 dia. | E2E-X3D□ E2E-X2E□ E2E-X2F□ E2E-X2Y□ E2E-X3T1 |
| | E2E-X8MD□ E2E-X5ME□ E2E-X5MF□ E2E-X5MY□ |
| M8 | E2E-X7D□ E2E-X5E□ E2E-X5F□ E2E-X5Y□ E2E-X7T1 |
| | E2E-X14MD□ E2E-X10ME□ E2E-X10MF□ E2E-X10MY□ |
| M12 | E2E-X10D□ E2E-X10E□ E2E-X10F□ E2E-X10Y□ E2E-X10T1 |
| | E2E-X20MD□ E2E-X18ME□ E2E-X18MF□ E2E-X18MY□ |
| M18 | |
| | |
| M30 | |
| | |

Mutual Interference

When installing Sensors face-to-face or side-by-side, ensure that the minimum distances given in the following table are maintained.



Mutual Interference

(Unit: mm)

| Model | | Item | M8 | M12 | M18 | M30 |
|-----------------------------------|------------|------|----|-----------|-----------|-----------|
| DC 2-Wire Models E2E-X□D□ | Shielded | A | 20 | 30 (20) | 50 (30) | 100 (50) |
| | | B | 15 | 20 (12) * | 35 (18) * | 70 (35) |
| AC/DC 2-Wire Models E2E-X□T1 | Unshielded | A | 80 | 120 (60) | 200 (100) | 300 (100) |
| | | B | 60 | 100 (50) | 110 (60) | 200 (100) |
| DC 3-Wire Models E2E-X□E□/X□F□ | Shielded | A | 20 | 30 (20) | 50 (30) | 100 (50) |
| | | B | 15 | 20 (12) * | 35 (18) * | 70 (35) |
| AC 2-Wire Models E2E-X□Y□ | Unshielded | A | 80 | 120 (60) | 200 (100) | 300 (100) |
| | | B | 60 | 100 (50) | 110 (60) | 200 (100) |

| Model | | Item | 3 dia. | 4 dia. | M5 | 5.4 dia. |
|--|----------|------|--------|--------|----|----------|
| DC 3-Wire Models E2E-X□C/B□ E2E-C□C/B□ | Shielded | A | 20 | | | |
| | | B | 15 | | | |

Note: Values in parentheses apply to Sensors operating at different frequencies.
 * Mutual interference will not occur for close-proximity mounting if models with different frequencies are used together.

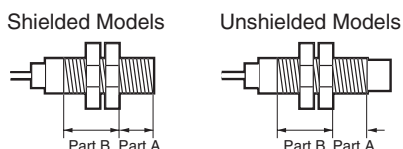
Loads with Large Surge Currents (E2E-X□T□)

If a load with a large surge current is connected, such as a relay, lamp, or motor, the surge current may cause the load short-circuit protection circuit to operate, resulting in operating errors.

● Mounting

Tightening Force

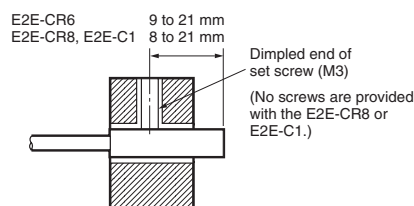
Do not tighten the nut with excessive force. A washer must be used with the nut.



Note: 1. The allowable tightening strength depends on the distance from the edge of the head, as shown in the following table. (A is the distance from the edge of the head. B includes the nut on the head side. If the edge of the nut is in part A, the tightening torque for part A applies instead.)
 2. The following strengths assume washers are being used.

| Model | Part A | | Part B |
|-------|------------|---------|--------|
| | Dimension | Torque | |
| M5 | | 1 N·m | |
| M8 | Shielded | 9 | 12 N·m |
| | Unshielded | 3 | |
| M12 | | 30 N·m | |
| M18 | | 70 N·m | |
| M30 | | 180 N·m | |

Refer to the following to mount the E2E-CR6, E2E-CR8 and E2E-C1 Unthreaded Cylindrical Models.



When using a set screw, tighten it to a torque of 0.2 N·m max. (E2E-C1: 0.4 N·m max.)

Connecting a DC 2-Wire Proximity Sensor to a PLC (Programmable Controller)

Required Conditions

Connection to a PLC is possible if the specifications of the PLC and the Proximity Sensor satisfy the following conditions. (The meanings of the symbols are given at the right.)

- The ON voltage of the PLC and the residual voltage of the Proximity Sensor must satisfy the following.
 $V_{ON} \leq V_{CC} - V_R$
- The OFF current of the PLC and the leakage current of the Proximity Sensor must satisfy the following.
 $I_{OFF} \geq I_{leak}$
 (If the OFF current is not listed in the PLC's input specifications, take it to be 1.3 mA.)
- The ON current of the PLC and the control output of the Proximity Sensor must satisfy the following.
 $I_{OUT} (min.) \leq I_{ON} \leq I_{OUT} (max.)$
 The ON current of the PLC will vary, however, with the power supply voltage and the input impedance, as shown in the following equation.
 $I_{ON} = (V_{CC} - V_R - V_{FC}) / R_{IN}$

Example

In this example, the above conditions are checked when the PLC Unit is the C200H-ID212, the Proximity Sensor is the E2E-X7D1-N, and the power supply voltage is 24 V.

- $V_{ON} (14.4 V) \leq V_{CC} (20.4 V) - V_R (3 V) = 17.4 V$: OK
- $I_{OFF} (1.3 mA) \geq I_{leak} (0.8 mA)$: OK
- $I_{ON} = [V_{CC} (20.4 V) - V_R (3 V) - V_{PLC} (4 V)] / R_{IN} (3 k\Omega) = \text{Approx. } 4.5 mA$
 Therefore, $I_{OUT} (min.) (3 mA) \leq I_{ON} (4.5 mA)$: OK
 Connection is thus possible.

| |
|--|
| V_{ON} : ON voltage of PLC (14.4 V) |
| I_{ON} : ON current of PLC (typically 7 mA) |
| I_{OFF} : OFF current of PLC (1.3 mA) |
| R_{IN} : Input impedance of PLC (3 kΩ) |
| V_{FC} : Internal residual voltage of PLC (4 V) |
| V_R : Output residual voltage of Proximity Sensor (3 V) |
| I_{leak} : Leakage current of Proximity Sensor (0.8 mA) |
| I_{OUT} : Control output of Proximity Sensor (3 to 100 mA) |
| V_{CC} : Power supply voltage (PLC: 20.4 to 26.4 V) |
| Values in parentheses apply to the following PLC model and Proximity Sensor model. |
| PLC: C200H-ID212 |
| Sensor: E2E-X7D1-N |

Dimensions

(Unit: mm)
Tolerance class IT16 applies to dimensions in this data sheet unless otherwise specified.

Main Units

Model Number-Dimensions Drawing Number Lookup Table

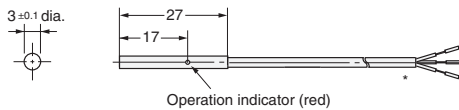
| Model | Shielded | Model | DC 2-Wire Models | | DC 3-Wire Models | | AC 2-Wire Models | | AC/DC 2-Wire Models | | | |
|--|------------|----------|-----------------------|-------|------------------|-------|------------------|-------|---------------------|-----|-----------|-----|
| | | Model | No. | Model | No. | Model | No. | Model | No. | | | |
| Pre-wired Models | Shielded | 3 dia. | --- | --- | E2E-CR6□ | 1 | --- | --- | --- | --- | | |
| | | 4 dia. | | | E2E-CR8□ | 2 | | | | | | |
| | | M5 | | | E2E-X1□ | 4 | | | | | | |
| | | 5.4 dia. | | | E2E-C1□ | 3 | | | | | | |
| | Unshielded | M8 | E2E-X2D□ | 5 | E2E-X1R5E□/F□ | 5 | E2E-X1R5Y□ | 7 | --- | --- | | |
| | | M12 | E2E-X3D□ | 9 | E2E-X2E□/F□ | 9 | E2E-X2Y□ | 11 | | | E2E-X3T1 | 13 |
| | | M18 | E2E-X7D□ | 14 | E2E-X5E□/F□ | 14 | E2E-X5Y□ | 14 | | | E2E-X7T1 | 14 |
| | | M30 | E2E-X10D□ | 16 | E2E-X10E□/F□ | 16 | E2E-X10Y□ | 16 | | | E2E-X10T1 | 16 |
| | | M8 | E2E-X4MD□ | 6 | E2E-X2ME□/F□ | 6 | E2E-X2MY□ | 8 | | | --- | --- |
| | | M12 | E2E-X8MD□ | 10 | E2E-X5ME□/F□ | 10 | E2E-X5MY□ | 12 | | | | |
| M18 | E2E-X14MD□ | 15 | E2E-X10ME□/F□ | 15 | E2E-X10MY□ | 15 | | | | | | |
| M30 | E2E-X20MD□ | 17 | E2E-X18ME□/F□ | 17 | E2E-X18MY□ | 17 | | | | | | |
| Connector Models (M12) | Shielded | M8 | E2E-X2D□-M1(G) | 18 | E2E-X1R5E/F□-M1 | 18 | --- | --- | --- | | | |
| | | M12 | E2E-X3D□-M1(G) | 20 | E2E-X2E/F□-M1 | 20 | E2E-X2Y□-M1 | | | 22 | | |
| | | M18 | E2E-X7D□-M1(G) | 24 | E2E-X5E/F□-M1 | 24 | E2E-X5Y□-M1 | | | 24 | | |
| | | M30 | E2E-X10D□-M1(G) | 26 | E2E-X10E/F□-M1 | 26 | E2E-X10Y□-M1 | | | 26 | | |
| | Unshielded | M8 | E2E-X4MD□-M1(G) | 19 | E2E-X2ME/F□-M1 | 19 | --- | --- | --- | | | |
| | | M12 | E2E-X8MD□-M1(G) | 21 | E2E-X5ME/F□-M1 | 21 | E2E-X5MY□-M1 | | | 23 | | |
| | | M18 | E2E-X14MD□-M1(G) | 25 | E2E-X10ME/F□-M1 | 25 | E2E-X10MY□-M1 | | | 25 | | |
| | | M30 | E2E-X20MD□-M1(G) | 27 | E2E-X18ME/F□-M1 | 27 | E2E-X18MY□-M1 | | | 27 | | |
| Connector Models (M8) | Shielded | M8 | E2E-X2D□-M3G | 28 | E2E-X1R5E/F□-M3 | 28 | --- | --- | --- | | | |
| | Unshielded | | E2E-X4MD□-M3G | 29 | E2E-X2ME/F□-M3 | 29 | | | | | | |
| Pre-wired Connector Models | Shielded | M8 | E2E-X2D□-M1(T)GJ(-U) | 30 | --- | --- | --- | --- | | | | |
| | | M12 | E2E-X3D□-M1(T)GJ(-U) | 31 | | | | | | | | |
| | | M18 | E2E-X7D□-M1(T)GJ(-U) | 33 | | | | | | | | |
| | | M30 | E2E-X10D□-M1(T)GJ(-U) | 35 | | | | | | | | |
| | Unshielded | M12 | E2E-X8MD1-M1(T)GJ | 32 | --- | --- | --- | --- | | | | |
| | | M18 | E2E-X14MD1-M1(T)GJ | 34 | | | | | | | | |
| | | M30 | E2E-X20MD1-M1(T)GJ | 36 | | | | | | | | |
| Pre-wired Connector Models (no polarity) | Shielded | M12 | E2E-X3D1-M1J-T | 31 | --- | --- | --- | --- | | | | |
| | | M18 | E2E-X7D□-M1J-T | 33 | | | | | | | | |
| | | M30 | E2E-X10D□-M1J-T | 35 | | | | | | | | |

Note 1. Two clamping nuts and one toothed washer are provided with M8 to M30 Models.
2. The model numbers of M8 to M30 Pre-wired Models are laser-marked on the milled section and cable section. This does not apply, however, to models that end in -U.

Pre-wired Models (Shielded)



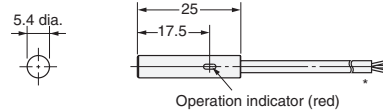
Diagram 1 E2E-CR6B□/CR6C□



*2.4-dia. vinyl-insulated round cable with 3 conductors
(Conductor cross section: 0.08 mm², Insulator diameter: 0.7 mm)

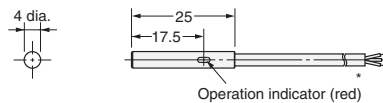


Diagram 3 E2E-C1B□/C1C□



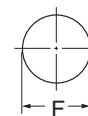
*2.9-dia. vinyl-insulated round cable with 3 conductors (Conductor cross section: 0.14 mm², Insulator diameter: 0.9 mm), Standard length: 2 m
Robotics Cable Models:
2.9-dia. vinyl-insulated round cable with 3 conductors (Conductor cross section: 0.15 mm², Insulator diameter: 1.05 mm), Standard length: 2 m
The cable can be extended up to 100 m (separate metal conduit).

Diagram 2 E2E-CR8B□/CR8C□



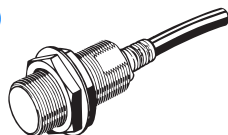
*2.9-dia. vinyl-insulated round cable with 3 conductors (Conductor cross section: 0.14 mm², Insulator diameter: 0.9 mm), Standard length: 2 m
Robotics Cable Models:
2.9-dia. vinyl-insulated round cable with 3 conductors (Conductor cross section: 0.15 mm², Insulator diameter: 1.05 mm), Standard length: 2 m
The cable can be extended up to 100 m (separate metal conduit).

Mounting Hole Dimensions



| Dimension | 3 dia. | 4 dia. | 5.4 dia. |
|-----------|---------------------------------------|---------------------------------------|---------------------------------------|
| F (mm) | 3.3 ^{+0.3} ₀ dia. | 4.2 ^{+0.5} ₀ dia. | 5.7 ^{+0.5} ₀ dia. |

Pre-wired Models (Shielded)

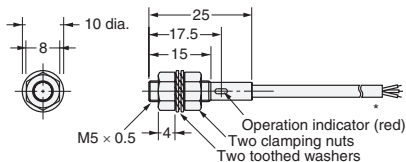


Mounting Hole Dimensions



| Dimension | M5 | M8 | M12 |
|-----------|---------------------------------------|---------------------------------------|--|
| F (mm) | 5.5 ^{+0.5} ₀ dia. | 8.5 ^{+0.5} ₀ dia. | 12.5 ^{+0.5} ₀ dia. |

Diagram 4 E2E-X1B□/X1C□



*2.9-dia. vinyl-insulated round cable with 3 conductors (Conductor cross section: 0.14 mm², Insulator diameter: 2.9 mm), Standard length: 2 m
 Robotics Cable Models:
 2.9-dia. vinyl-insulated round cable with 3 conductors (Conductor cross section: 0.15 mm², Insulator diameter: 1.05 mm), Standard length: 2 m
 The cable can be extended up to 100 m (separate metal conduit).

Pre-wired Models (Unshielded)

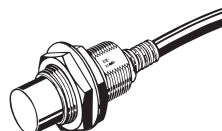
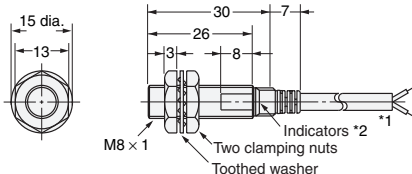
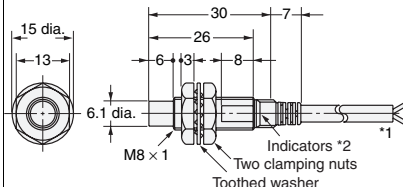


Diagram 5 E2E-X2D□
E2E-X1R5E□/F□



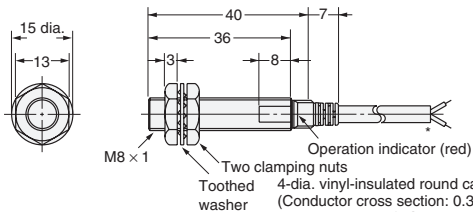
*1. 4-dia. vinyl-insulated round cable with 2 conductors (Conductor cross section: 0.3 mm², Insulator diameter: 1.3 mm), Standard length: 2 m
 4-dia. vinyl-insulated round cable with 3 conductors (Conductor cross section: 0.3 mm², Insulator diameter: 1.3 mm), Standard length: 2 m
 Robotics Cable Models:
 4-dia. vinyl-insulated round cable with 2 conductors (Conductor cross section: 0.3 mm², Insulator diameter: 1.27 mm), Standard length: 2 m
 4-dia. vinyl-insulated round cable with 3 conductors (Conductor cross section: 0.3 mm², Insulator diameter: 1.27 mm), Standard length: 2 m
 Models with Highly Oil-resistant Cables:
 4-dia. polyurethane-insulated round cable with 2 conductors (Conductor cross section: 0.3 mm², Insulator diameter: 1.3 mm), Standard length: 2 m
 The cable can be extended up to 200 m (separate metal conduit).
 *2. D1 Models: Operation indicator (red) and setting indicator (green), D2/E/F Models: Operation indicator (red)

Diagram 6 E2E-X4MD□
E2E-X2ME□/F□



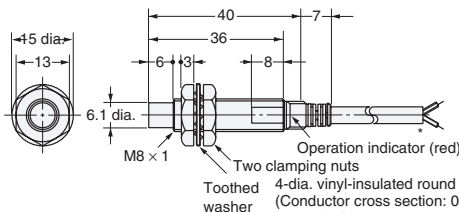
*1. 4-dia. vinyl-insulated round cable with 2 conductors (Conductor cross section: 0.3 mm², Insulator diameter: 1.3 mm), Standard length: 2 m
 4-dia. vinyl-insulated round cable with 3 conductors (Conductor cross section: 0.3 mm², Insulator diameter: 1.3 mm), Standard length: 2 m
 Robotics Cable Models:
 4-dia. vinyl-insulated round cable with 2 conductors (Conductor cross section: 0.3 mm², Insulator diameter: 1.27 mm), Standard length: 2 m
 4-dia. vinyl-insulated round cable with 3 conductors (Conductor cross section: 0.3 mm², Insulator diameter: 1.27 mm), Standard length: 2 m
 The cable can be extended up to 200 m (separate metal conduit).
 *2. D1 Models: Operation indicator (red) and setting indicator (green), D2/E/F Models: Operation indicator (red)

Diagram 7 E2E-X1R5Y□



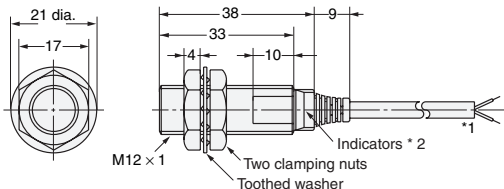
4-dia. vinyl-insulated round cable with 2 conductors (Conductor cross section: 0.3 mm², Insulator diameter: 1.3 mm), Standard length: 2 m
 The cable can be extended up to 200 m (separate metal conduit).

Diagram 8 E2E-X2MY□



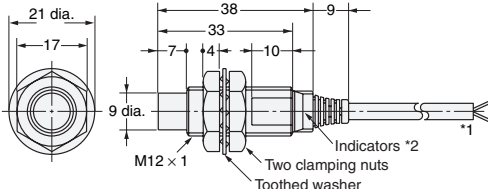
4-dia. vinyl-insulated round cable with 2 conductors (Conductor cross section: 0.3 mm², Insulator diameter: 1.3 mm), Standard length: 2 m
 The cable can be extended up to 200 m (separate metal conduit).

Diagram 9 E2E-X3D□
E2E-X2E□/F□



*1. 4-dia. vinyl-insulated round cable with 2 conductors (Conductor cross section: 0.3 mm², Insulator diameter: 1.3 mm), Standard length: 2 m
 4-dia. vinyl-insulated round cable with 3 conductors (Conductor cross section: 0.3 mm², Insulator diameter: 1.3 mm), Standard length: 2 m
 Robotics Cable Models:
 4-dia. vinyl-insulated round cable with 2 conductors (Conductor cross section: 0.3 mm², Insulator diameter: 1.27 mm), Standard length: 2 m
 4-dia. vinyl-insulated round cable with 3 conductors (Conductor cross section: 0.3 mm², Insulator diameter: 1.27 mm), Standard length: 2 m
 Models with Highly Oil-resistant Cables:
 4-dia. polyurethane-insulated round cable with 2 conductors (Conductor cross section: 0.3 mm², Insulator diameter: 1.3 mm), Standard length: 2 m
 The cable can be extended (separate metal conduit) up to 200 m for the control output and up to 100 m for the diagnostic output.
 *2. D1 Models: Operation indicator (red) and setting indicator (green), D2/E/F Models: Operation indicator (red)

Diagram 10 E2E-X8MD□
E2E-X5ME□/F□



*1. 4-dia. vinyl-insulated round cable with 2 conductors (Conductor cross section: 0.3 mm², Insulator diameter: 1.3 mm), Standard length: 2 m
 4-dia. vinyl-insulated round cable with 3 conductors (Conductor cross section: 0.3 mm², Insulator diameter: 1.3 mm), Standard length: 2 m
 Robotics Cable Models:
 4-dia. vinyl-insulated round cable with 2 conductors (Conductor cross section: 0.3 mm², Insulator diameter: 1.27 mm), Standard length: 2 m
 4-dia. vinyl-insulated round cable with 3 conductors (Conductor cross section: 0.3 mm², Insulator diameter: 1.27 mm), Standard length: 2 m
 The cable can be extended (separate metal conduit) up to 200 m for the control output and up to 100 m for the diagnostic output.
 *2. D1 Models: Operation indicator (red) and setting indicator (green), D2/E/F Models: Operation indicator (red)

Diagram 11 E2E-X2Y□

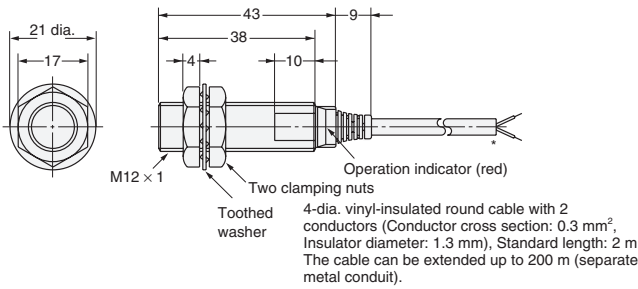
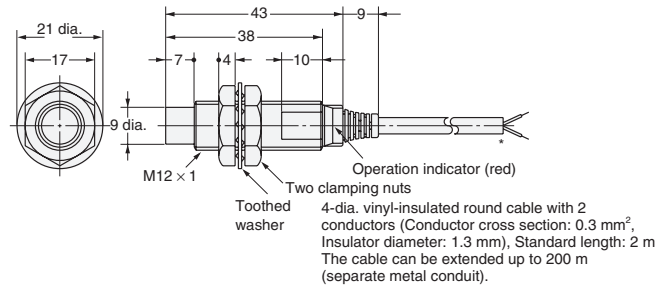


Diagram 12 E2E-X5MY□



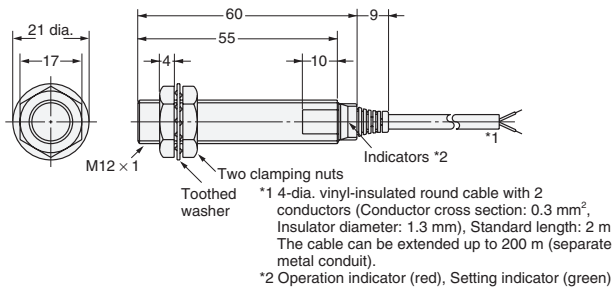
Pre-wired Models (Shielded)

Mounting Hole Dimensions



| Dimension | M8 | M12 | M18 | M30 |
|-----------|--------------------------|---------------------------|---------------------------|---------------------------|
| F (mm) | 8.5 ^{+0.5} dia. | 12.5 ^{+0.5} dia. | 18.5 ^{+0.5} dia. | 30.5 ^{+0.5} dia. |

Diagram 13 E2E-X3T1



Pre-wired Models (Unshielded)

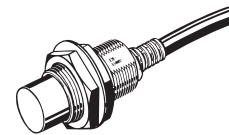


Diagram 14 E2E-X7D□/E2E-X5E□/F□
E2E-X5Y□/E2E-X7T1

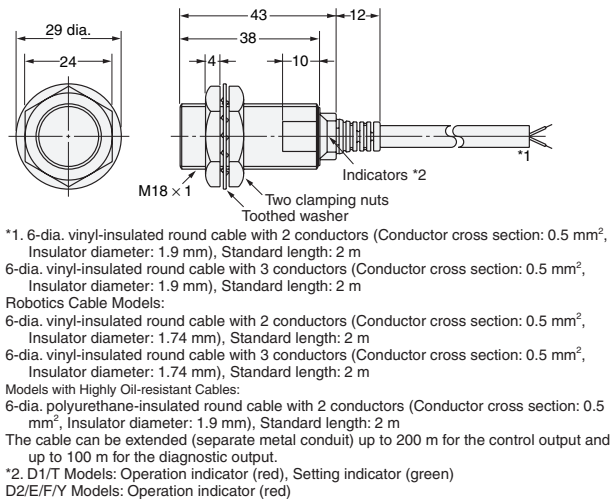
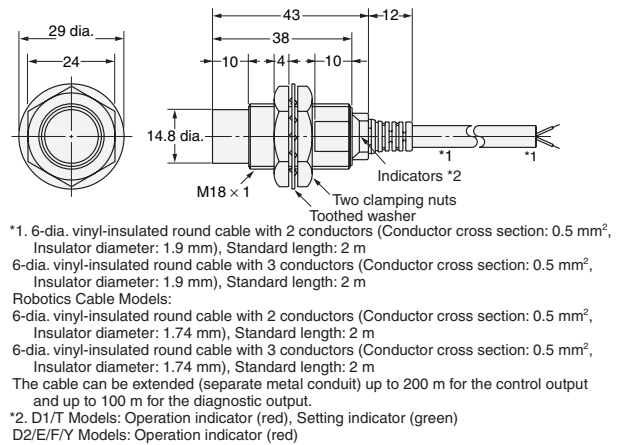
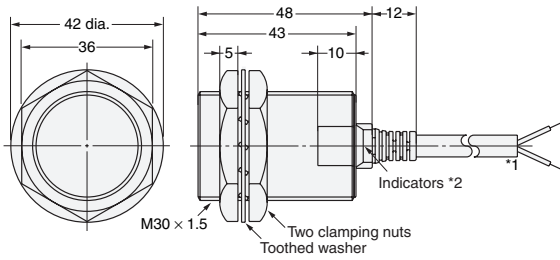


Diagram 15 E2E-X14MD□/E2E-X10ME□/F□
E2E-X10MY□

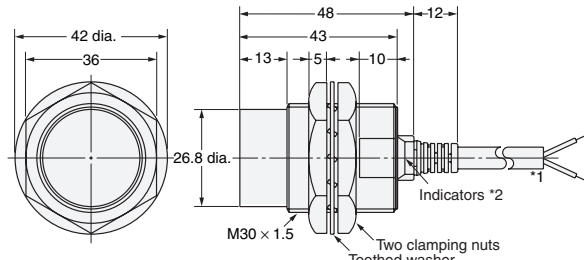


**Diagram 16 E2E-X10D□/E2E-X10E□/F□
E2E-X10Y□/E2E-X10T1**



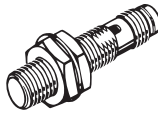
*1. 6-dia. vinyl-insulated round cable with 2 conductors (Conductor cross section: 0.5 mm², Insulator diameter: 1.9 mm), Standard length: 2 m
 6-dia. vinyl-insulated round cable with 3 conductors (Conductor cross section: 0.5 mm², Insulator diameter: 1.9 mm), Standard length: 2 m
 Robotics Cable Models:
 6-dia. vinyl-insulated round cable with 2 conductors (Conductor cross section: 0.5 mm², Insulator diameter: 1.74 mm), Standard length: 2 m
 6-dia. vinyl-insulated round cable with 3 conductors (Conductor cross section: 0.5 mm², Insulator diameter: 1.74 mm), Standard length: 2 m
 Models with Highly Oil-resistant:
 6-dia. polyurethane-insulated round cable with 2 conductors (Conductor cross section: 0.5 mm², Insulator diameter: 1.9 mm), Standard length: 2 m
 The cable can be extended (separate metal conduit) up to 200 m for the control output and up to 100 m for the diagnostic output.
 *2. D1/T Models: Operation indicator (red), Setting indicator (green)
 D2/E/F/Y Models: Operation indicator (red)

**Diagram 17 E2E-X20MD□/E2E-X18ME□/F□
E2E-X18MY□**



*1. 6-dia. vinyl-insulated round cable with 2 conductors (Conductor cross section: 0.5 mm², Insulator diameter: 1.9 mm), Standard length: 2 m
 6-dia. vinyl-insulated round cable with 3 conductors (Conductor cross section: 0.5 mm², Insulator diameter: 1.9 mm), Standard length: 2 m
 Robotics Cable Models:
 6-dia. vinyl-insulated round cable with 2 conductors (Conductor cross section: 0.5 mm², Insulator diameter: 1.74 mm), Standard length: 2 m
 6-dia. vinyl-insulated round cable with 3 conductors (Conductor cross section: 0.5 mm², Insulator diameter: 1.74 mm), Standard length: 2 m
 The cable can be extended (separate metal conduit) up to 200 m for the control output and up to 100 m for the diagnostic output.
 *2. D1/T Models: Operation indicator (red), Setting indicator (green)
 D2/E/F/Y Models: Operation indicator (red)

M8 Connector Models (Shielded)



M8 Connector Models (Unshielded)

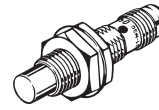
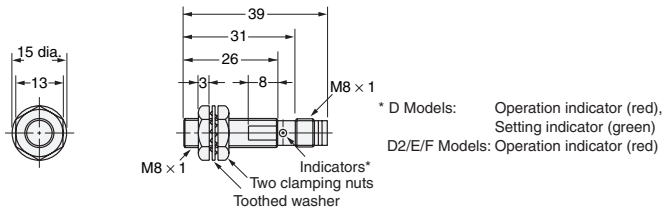
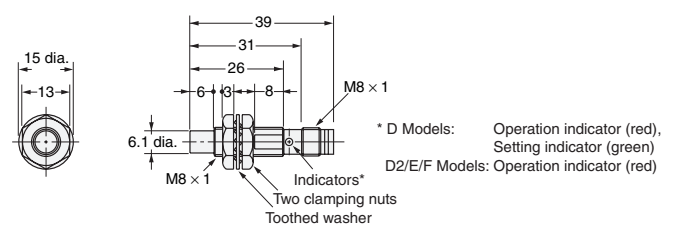


Diagram 28 E2E-X2D□-M3G/E2E-X1R5E□-M3/X1RF□-M3



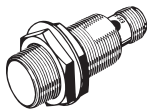
* D Models: Operation indicator (red), Setting indicator (green)
 D2/E/F Models: Operation indicator (red)

Diagram 29 E2E-X4MD□-M3G/E2E-X2ME□-M3/X2MF□-M3

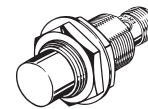


* D Models: Operation indicator (red), Setting indicator (green)
 D2/E/F Models: Operation indicator (red)

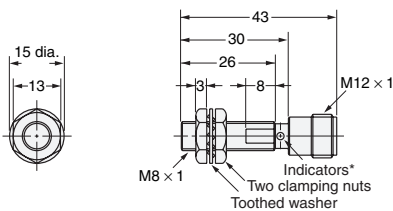
M12 Connector Models (Shielded)



M12 Connector Models (Unshielded)

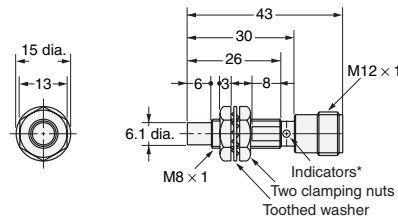


**Diagram 18 E2E-X2D□-M1(G)
E2E-X1R5E□-M1/E2E-X1R5F□-M1**



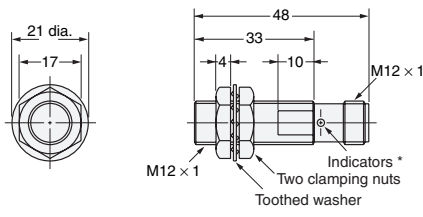
* D1 Models: Operation indicator (red), Setting indicator (green)
 D2/E/F Models: Operation indicator (red)

**Diagram 19 E2E-X4MD□-M1(G)
E2E-X2ME□-M1/E2E-X2MF□-M1**



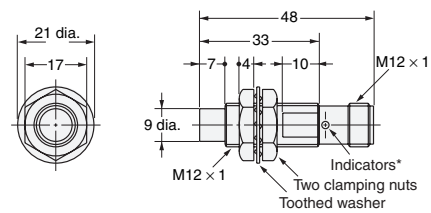
* D1 Models: Operation indicator (red), Setting indicator (green)
 D2/E/F Models: Operation indicator (red)

**Diagram 20 E2E-X3D□-M1(G)
E2E-X2E□-M1/E2E-X2F□-M1**



* D1 Models: Operation indicator (red),
Setting indicator (green)
D2/E/F Models: Operation indicator (red)

**Diagram 21 E2E-X8MD□-M1(G)
E2E-X5ME□-M1/E2E-X5MF□-M1**



* D1 Models: Operation indicator (red), Setting indicator (green)
D2/E/F Models: Operation indicator (red)

Diagram 22 E2E-X2Y□-M1

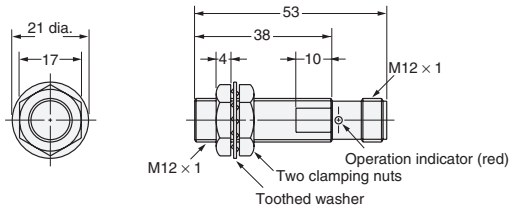
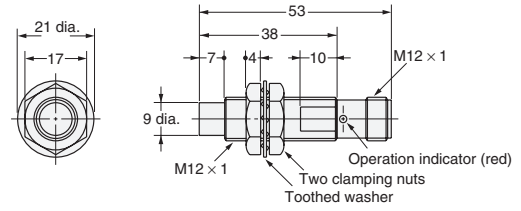
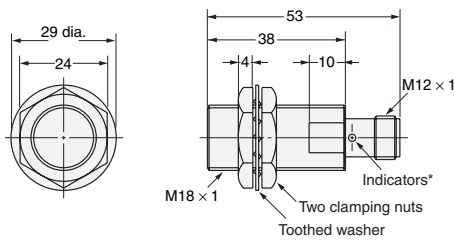


Diagram 23 E2E-X5MY□-M1

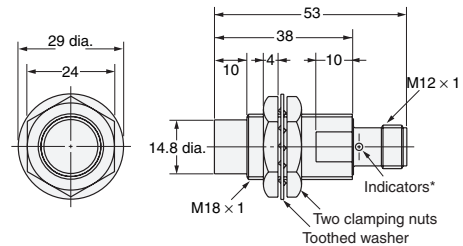


**Diagram 24 E2E-X7D□-M1(G)/E2E-X5E□-M1/X5F□-M1
E2E-X5Y□-M1**



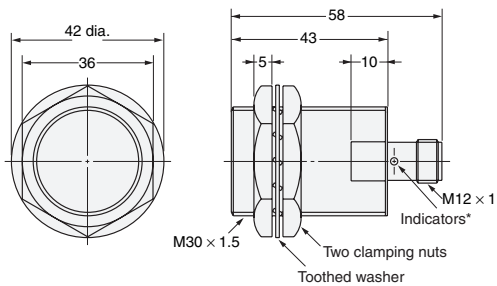
* D1 Models: Operation indicator (red), Setting indicator (green)
D2/E/Y Models: Operation indicator (red)

**Diagram 25 E2E-X14MD□-M1(G)/E2E-X10ME□-M1
X10MF□-M1
E2E-X10MY□-M1**



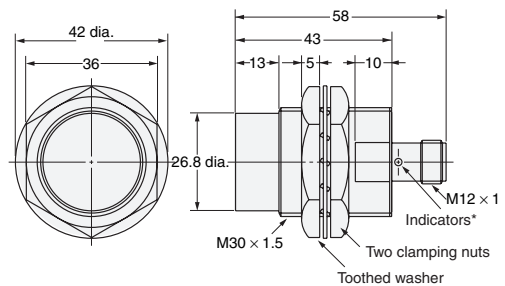
* D1 Models: Operation indicator (red), Setting indicator (green)
D2/E/Y Models: Operation indicator (red)

**Diagram 26 E2E-X10D□-M1(G)/E2E-X10E□-M1/X10F□-M1
E2E-X10Y□-M1**



* D1 Models: Operation indicator (red), Setting indicator (green)
D2/E/Y Models: Operation indicator (red)

**Diagram 27 E2E-X20MD□-M1(G)/E2E-X18ME□-M1/
X18MF□-M1
E2E-X18MY□-M1**



* D1 Models: Operation indicator (red), Setting indicator (green)
D2/E/Y Models: Operation indicator (red)

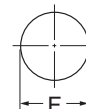
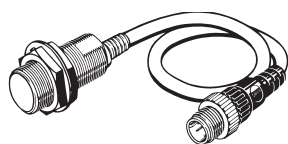
Mounting Hole Dimensions



| Dimensions | M8 | M12 | M18 | M30 |
|------------|---------------------------------------|--|--|--|
| F (mm) | 8.5 ^{+0.5} ₀ dia. | 12.5 ^{+0.5} ₀ dia. | 18.5 ^{+0.5} ₀ dia. | 30.5 ^{+0.5} ₀ dia. |

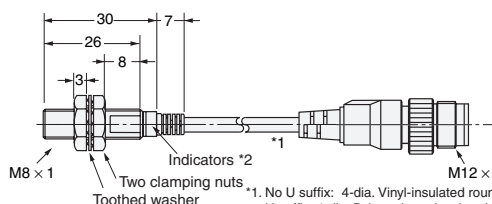
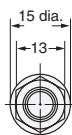
Pre-wired Connector Models (Shielded)

Mounting Hole Dimensions



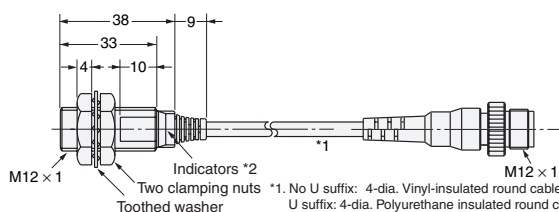
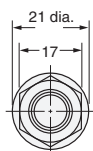
| Dimension | M12 | M18 | M30 |
|-----------|--|--|--|
| F (mm) | 12.5 ^{+0.5} ₀ dia. | 18.5 ^{+0.5} ₀ dia. | 30.5 ^{+0.5} ₀ dia. |

Diagram 30 E2E-X2D□-M1TGJ-U *3
E2E-X2D1-M1TGJ



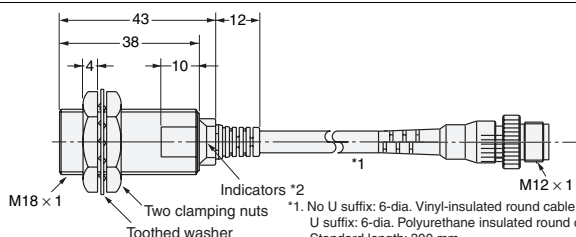
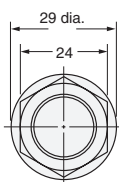
- *1. No U suffix: 4-dia. Vinyl-insulated round cable
U suffix: 4-dia. Polyurethane insulated round cable,
Standard length: 300 mm
- *2. D1 Models: Operation indicator (red), Setting indicator (green)
D2 Models: Operation indicator (red)
- *3. The connectors for M1TGJ models are XS5 Smartclick connectors.

Diagram 31 E2E-X3D□-M1GJ
E2E-X3D1-M1J-T
E2E-X3D□-M1TGJ-U *3
E2E-X3D1-M1TGJ



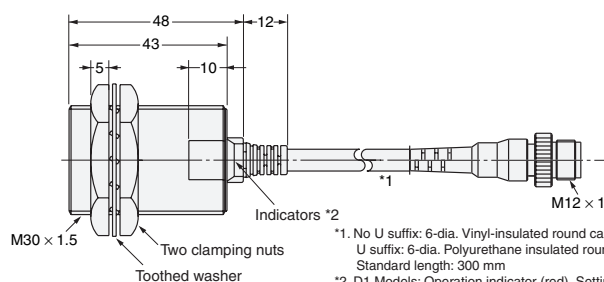
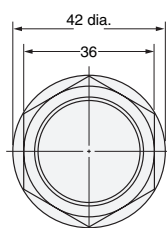
- *1. No U suffix: 4-dia. Vinyl-insulated round cable
U suffix: 4-dia. Polyurethane insulated round cable,
Standard length: 300 mm
- *2. D1 Models: Operation indicator (red), Setting indicator (green)
D2 Models: Operation indicator (red)
- *3. The connectors for M1TGJ models are XS5 Smartclick connectors.

Diagram 33 E2E-X7D□-M1GJ
E2E-X7D□-M1J-T
E2E-X7D□-M1TGJ-U *3
E2E-X7D1-M1TGJ



- *1. No U suffix: 6-dia. Vinyl-insulated round cable
U suffix: 6-dia. Polyurethane insulated round cable,
Standard length: 300 mm
- *2. D1 Models: Operation indicator (red), Setting indicator (green)
D2 Models: Operation indicator (red)
- *3. The connectors for M1TGJ models are XS5 Smartclick connectors.

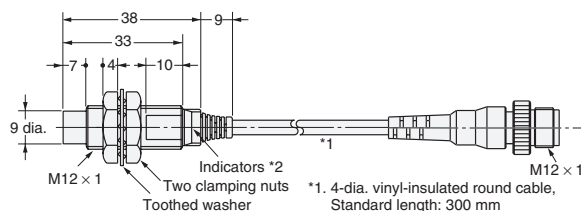
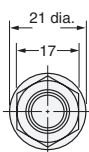
Diagram 35 E2E-X10D□-M1GJ
E2E-X10D□-M1J-T
E2E-X10D□-M1TGJ-U *3
E2E-X10D1-M1TGJ



- *1. No U suffix: 6-dia. Vinyl-insulated round cable
U suffix: 6-dia. Polyurethane insulated round cable,
Standard length: 300 mm
- *2. D1 Models: Operation indicator (red), Setting indicator (green)
D2 Models: Operation indicator (red)
- *3. The connectors for M1TGJ models are XS5 Smartclick connectors.

Pre-wired Connector Models (Unshielded)

Diagram 32 E2E-X8MD1-M1GJ
E2E-X8MD1-M1TGJ



- *1. 4-dia. vinyl-insulated round cable,
Standard length: 300 mm
- *2. Operation indicator (red), Setting
indicator (green)

Diagram 34 E2E-X14MD□-M1GJ
E2E-X14MD1-M1TGJ

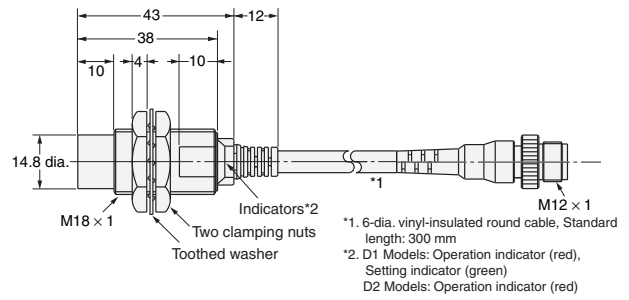
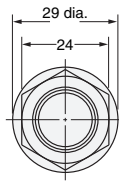
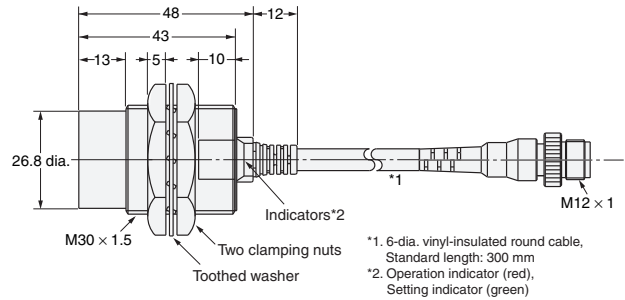
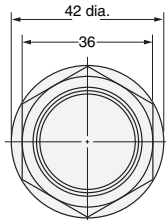
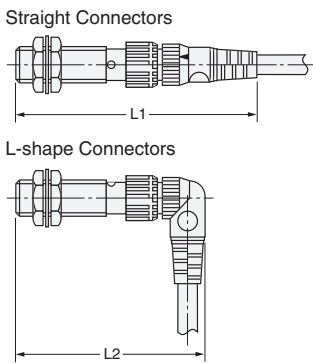


Diagram 36 E2E-X20MD1-M1GJ
E2E-X20MD1-M1TGJ

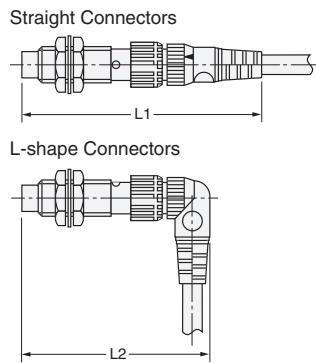


Dimensions for Proximity Sensors with Sensor I/O Connectors

Shielded Models



Unshielded Models



Dimensions with the XS2F Connected (Unit: mm)

| Dimension | L1 | L2 |
|------------------------|------------|------------|
| Sensor diameter | | |
| M8 | Approx. 75 | Approx. 62 |
| M12* | DC | Approx. 80 |
| | AC | Approx. 85 |
| M18 | Approx. 85 | Approx. 72 |
| M30 | Approx. 90 | Approx. 77 |

* The overall length of the Sensor is different between AC and DC Models for Sensors with diameters of M12. This will change the dimension when the I/O Connector is connected.

Dimensions with the XS3F Connected (Unit: mm)

| Dimension | L1 | L2 |
|------------------------|------------|------------|
| Sensor diameter | | |
| M8 | Approx. 65 | Approx. 54 |

Accessories (Order Separately)

Sensor I/O Connectors

Refer to *Introduction to Sensor I/O Connectors/Sensor Controllers* for details.

- Mounting Brackets
- Protective Covers
- Sputter Protective Covers

Refer to Y92□ for details.

Terms and Conditions Agreement

Read and understand this catalog.

Please read and understand this catalog before purchasing the products. Please consult your OMRON representative if you have any questions or comments.

Warranties.

(a) Exclusive Warranty. Omron's exclusive warranty is that the Products will be free from defects in materials and workmanship for a period of twelve months from the date of sale by Omron (or such other period expressed in writing by Omron). Omron disclaims all other warranties, express or implied.

(b) Limitations. OMRON MAKES NO WARRANTY OR REPRESENTATION, EXPRESS OR IMPLIED, ABOUT NON-INFRINGEMENT, MERCHANTABILITY OR FITNESS FOR A PARTICULAR PURPOSE OF THE PRODUCTS. BUYER ACKNOWLEDGES THAT IT ALONE HAS DETERMINED THAT THE PRODUCTS WILL SUITABLY MEET THE REQUIREMENTS OF THEIR INTENDED USE.

Omron further disclaims all warranties and responsibility of any type for claims or expenses based on infringement by the Products or otherwise of any intellectual property right. (c) Buyer Remedy. Omron's sole obligation hereunder shall be, at Omron's election, to (i) replace (in the form originally shipped with Buyer responsible for labor charges for removal or replacement thereof) the non-complying Product, (ii) repair the non-complying Product, or (iii) repay or credit Buyer an amount equal to the purchase price of the non-complying Product; provided that in no event shall Omron be responsible for warranty, repair, indemnity or any other claims or expenses regarding the Products unless Omron's analysis confirms that the Products were properly handled, stored, installed and maintained and not subject to contamination, abuse, misuse or inappropriate modification. Return of any Products by Buyer must be approved in writing by Omron before shipment. Omron Companies shall not be liable for the suitability or unsuitability or the results from the use of Products in combination with any electrical or electronic components, circuits, system assemblies or any other materials or substances or environments. Any advice, recommendations or information given orally or in writing, are not to be construed as an amendment or addition to the above warranty.

See <http://www.omron.com/global/> or contact your Omron representative for published information.

Limitation on Liability; Etc.

OMRON COMPANIES SHALL NOT BE LIABLE FOR SPECIAL, INDIRECT, INCIDENTAL, OR CONSEQUENTIAL DAMAGES, LOSS OF PROFITS OR PRODUCTION OR COMMERCIAL LOSS IN ANY WAY CONNECTED WITH THE PRODUCTS, WHETHER SUCH CLAIM IS BASED IN CONTRACT, WARRANTY, NEGLIGENCE OR STRICT LIABILITY.

Further, in no event shall liability of Omron Companies exceed the individual price of the Product on which liability is asserted.

Suitability of Use.

Omron Companies shall not be responsible for conformity with any standards, codes or regulations which apply to the combination of the Product in the Buyer's application or use of the Product. At Buyer's request, Omron will provide applicable third party certification documents identifying ratings and limitations of use which apply to the Product. This information by itself is not sufficient for a complete determination of the suitability of the Product in combination with the end product, machine, system, or other application or use. Buyer shall be solely responsible for determining appropriateness of the particular Product with respect to Buyer's application, product or system. Buyer shall take application responsibility in all cases.

NEVER USE THE PRODUCT FOR AN APPLICATION INVOLVING SERIOUS RISK TO LIFE OR PROPERTY OR IN LARGE QUANTITIES WITHOUT ENSURING THAT THE SYSTEM AS A WHOLE HAS BEEN DESIGNED TO ADDRESS THE RISKS, AND THAT THE OMRON PRODUCT(S) IS PROPERLY RATED AND INSTALLED FOR THE INTENDED USE WITHIN THE OVERALL EQUIPMENT OR SYSTEM.

Programmable Products.

Omron Companies shall not be responsible for the user's programming of a programmable Product, or any consequence thereof.

Performance Data.

Data presented in Omron Company websites, catalogs and other materials is provided as a guide for the user in determining suitability and does not constitute a warranty. It may represent the result of Omron's test conditions, and the user must correlate it to actual application requirements. Actual performance is subject to the Omron's Warranty and Limitations of Liability.

Change in Specifications.

Product specifications and accessories may be changed at any time based on improvements and other reasons. It is our practice to change part numbers when published ratings or features are changed, or when significant construction changes are made. However, some specifications of the Product may be changed without any notice. When in doubt, special part numbers may be assigned to fix or establish key specifications for your application. Please consult with your Omron's representative at any time to confirm actual specifications of purchased Product.

Errors and Omissions.

Information presented by Omron Companies has been checked and is believed to be accurate; however, no responsibility is assumed for clerical, typographical or proofreading errors or omissions.