

Temperature Controllers

E5CSV

Simple to Set and Operate 1/16 DIN Size Controllers

- Easy setting using internal DIP and rotary switches
- ON/OFF or PID control (with on-demand auto-tuning) selectable
- Clearly visible digital display with character height of 13.5 mm
- Deviation indicator makes monitoring more effective
- Multiple temperature sensor input (thermocouple/platinum resistance thermometer) models stocked; thermocouple input only and platinum RTD input only models available
- Models with two alarms are ideal for temperature alarm applications
- Setting change protection prohibits tampering
- Sampling rate (500 ms) and selectable control period (2 and 20 s) improves response
- 8-mode alarm output and sensor error detection
- "Input shift" function adjusts display to reflect known sensor offsets



NEW

- °C or °F field selectable
- Black or white cases available to match panel aesthetics
- RoHS compliant
- Water-resistant front panel rated NEMA 4X/IP66
- Compact: measures 48 H x 48 W x 78 D mm
- Accuracy ±0.5% of value

Model Number Structure

■ Model Number Legend

Models with Terminal Blocks

E5CSV-□□□□-□□
1 2 3 4 5 6

1. Output type

- R: Relay
- Q: Voltage for driving SSR

2. Number of alarms

- Blank: No alarm
- 1: 1 alarm
- 2: 2 alarms

3. Input type

- T: Thermocouple/platinum resistance thermometer (multi-input)
- KJ: Thermocouple
- P: Platinum resistance thermometer

4. Power supply voltage

- Blank: 100 to 240 VAC
- D: 24 VAC/VDC

5. Case color / Display scale

- Blank: Black
- W: Light gray
- F: Scale marked in °F (Black case only)

6. Power supply voltage

- AC100-240: 100 to 240 VAC
- AC/DC24: 24 VAC/VDC

Note: A functional explanation is provided here for illustration, but models are not necessarily available for all possible combinations. Please refer to *Ordering Information* when ordering.

Examples

- Voltage control output, without alarm, multi-input, light gray case: 115 VAC: E5CSV-QT-W AC100-240
- Relay control output, one alarm output, multi-input, black case: 24 VDC: E5CSV-R1TD AC/DC24

Ordering Information

■ List of Models

Size	Power supply voltage	Number of alarm points	Control output	TC/Pt multi-input Case color: Black Scale marked in °C	TC input Case color: Light gray Scale marked in °C	Pt input Case color: Light gray Scale marked in °C	TC/Pt multi-input Case color: Black Scale marked in °F
1/16 DIN 48 × 48 × 78 mm (W × H × D)	100 to 240 VAC	0	Relay	E5CSV-RT AC100-240			E5CSV-RT-F AC100-240
			Voltage (for driving SSR)	E5CSV-QT AC100-240			E5CSV-QT-F AC100-240
		1	Relay	E5CSV-R1T AC100-240	E5CSV-R1KJ-W	E5CSV-R1P-W	E5CSV-R1T-F AC100-240
			Voltage (for driving SSR)	E5CSV-Q1T AC100-240	E5CSV-Q1KJ-W	E5CSV-Q1P-W	E5CSV-Q1T-F AC100-240
		2 (See note)	Relay	E5CSV-R2T AC100-240			E5CSV-R2T-F AC100-240
			Voltage (for driving SSR)	E5CSV-Q2T AC100-240			E5CSV-Q2T-F AC100-240
	24 VAC/ VDC	0	Relay	E5CSV-RTD AC/DC24			
			Voltage (for driving SSR)	E5CSV-QTD AC/DC24			
		1	Relay	E5CSV-R1TD AC/DC24			E5CSV-R1TD-F AC/DC24
			Voltage (for driving SSR)	E5CSV-Q1TD AC/DC24			E5CSV-Q1TD-F AC/DC24
		2 (See note)	Relay	E5CSV-R2TD AC/DC24			
			Voltage (for driving SSR)	E5CSV-Q2TD AC/DC24			

Note: Models with two alarm outputs always use the upper limit alarm mode for the alarm 2 output.

■ Accessories (Order Separately)

Protective Cover

Type	Model
Hard Protective Cover	Y92A-48B

Terminal Cover

Model
E53-COV10

Specifications

■ Ratings

Supply voltage	100 to 240 VAC, 50/60 Hz	24 VAC/VDC, 50/60 Hz
Operating voltage range	85% to 110% of rated supply voltage	
Power consumption	5 VA	3 VA/2 W
Sensor input	Thermocouple input type: Platinum resistance thermometer input type: Multi-input (thermocouple/platinum resistance thermometer) type:	K, J, L Pt100, JPt100 K, J, L, T, U, N, R, Pt100, JPt100
Control output	Relay output	SPST-NO, 250 VAC, 3A (resistive load)
	Voltage output (for driving the SSR)	12 VDC, 21 mA (with short-circuit protection circuit)3
Control method	ON/OFF or 2-PID (with auto-tuning)	
Alarm output	SPST-NO, 250 VAC, 1A (resistive load)	
Setting method	Digital setting using front panel keys	
Indication method	3.5 digit, 7-segment digital display (character height: 13.5 mm) and deviation indicators	
Other functions	<ul style="list-style-type: none"> • Setting change prohibit (key protection) • Input shift • Temperature unit change (°C/°F) • Direct/reverse operation • Temperature range, Sensor switching (K/J/L, Pt100/JPt100) • Switching is performed between a thermocouple and platinum resistance thermometer for multi-input models. • Control period switching • 8-mode alarm output • Sensor error detection 	
Ambient temperature	-10 to 55° C (with no condensation or icing)	
Ambient humidity	25% to 85%	
Storage temperature	-25 to 65° C (with no condensation or icing)	

■ Characteristics

Setting accuracy	Thermocouple (See note 1.):	(±0.5% of indication value or ±1°C, whichever is greater) ±1 digit max.
Indication accuracy (ambient temperature of 23°C)	Platinum resistance thermometer (See note 2.):	(±0.5% of indication value or ±1°C, whichever is greater) ±1 digit max.
Influence of temperature	R thermocouple inputs:	(±1% of PV or ±10°C, whichever is greater) ±1 digit max.
Influence of voltage	Other thermocouple inputs:	(±1% of PV or ±4°C, whichever is greater) ±1 digit max.
	Platinum resistance thermometer inputs:	(±1% of PV or ±2°C, whichever is greater) ±1 digit max.
Hysteresis (for ON/OFF control)	0.2% FS (0.1% FS for multi-input (thermocouple/platinum resistance thermometer) models)	
Proportional band (P)	1 to 999°C (automatic adjustment using auto-tuning/self-tuning)	
Integral time (I)	1 to 1,999 s (automatic adjustment using auto-tuning/self-tuning)	
Derivative time (D)	1 to 1,999 s (automatic adjustment using auto-tuning/self-tuning)	
Alarm output range	Absolute-value alarm:	Same as the control range
	Other:	0% to 100% FS
	Alarm hysteresis:	0.2°C or °F (fixed)
Control period	2/20 s	
Sampling period	500 ms	
Insulation resistance	20 MΩ min. (at 500 VDC)	
Dielectric strength	2,000 VAC, 50/60 Hz for 1 min between current-carrying terminals of different polarity	
Vibration resistance	Malfunction	10 to 55 Hz, 20 m/s ² for 10 min each in X, Y, and Z directions
	Destruction	10 to 55 Hz, 0.75-mm single amplitude for 2 hr each in X, Y, and Z directions
Shock resistance	Malfunction	100 m/s ² min., 3 times each in 6 directions
	Destruction	300 m/s ² min., 3 times each in 6 directions
Life expectancy	Electrical	100,000 operations min. (relay output models)
Weight	Approx. 120 g (Controller only)	
Degree of protection	Front panel: Equivalent to IP66; Rear case: IP20; Terminals: IP00	
Memory protection	EEPROM (non-volatile memory) (number of writes: 1,000,000)	
EMC	EMI Radiated:	EN 55011 Group 1 Class A
	EMI Conducted:	EN 55011 Group 1 Class A
	ESD Immunity:	EN 61000-4-2: 4 kV contact discharge (level 2) 8 kV air discharge (level 3)
	Radiated Electromagnetic Field Immunity:	EN 61000-4-3: 10 V/m (80-1000 MHz, 1.4-2.0 GHz amplitude modulated) (level 3) 10 V/m (900 MHz pulse modulated)
	Conducted Disturbance Immunity:	EN 61000-4-6: 3 V (0.15 to 80 MHz) (level 2)
	Noise Immunity (First Transient Burst Noise):	EN 61000-4-4
	Burst Immunity:	2 kV power-line (level 3), 1 kV I/O signal-line (level 3)
	Surge Immunity:	EN 61000-4-5: Power line: Normal mode 1 kV; Common mode 2 kV Output line (relay output): Normal mode 1 kV; Common mode 2 kV
	Voltage Dip/Interrupting Immunity:	EN 61000-4-11 0.5 cycle, 100% (rated voltage)
Approved standards	UL 61010C-1 (listing) CSA C22.2 No.1010-1	
Conformed standards	EN 61326, EN 61010-1, IEC 61010-1 VDE 0106 Part 100 (finger protection), when the terminal cover is mounted.	

- Note: 1.** The following exceptions apply to thermocouples.
- U, L: ±2°C ±1 digit max.
 - R: ±3°C ±1 digit max. at 200°C or less
- 2.** The following exceptions apply to platinum resistance thermometers.
- Input set values 0, 1, 2, 3 for E5CSV: 0.5% FS ±1 digit max.
Input set value 1 for E5CSV: 0.5% FS ±1 digit max.

■ Electrical Life Expectancy Curve for Relays (Reference Values)

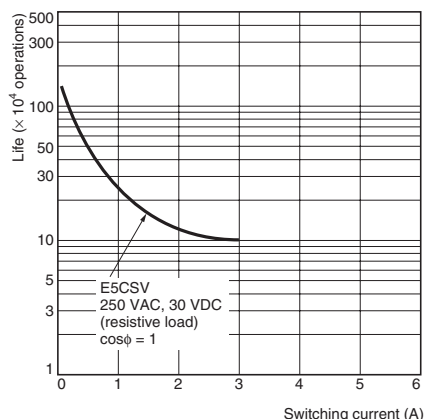

Temperature Range

Thermocouple Input Models

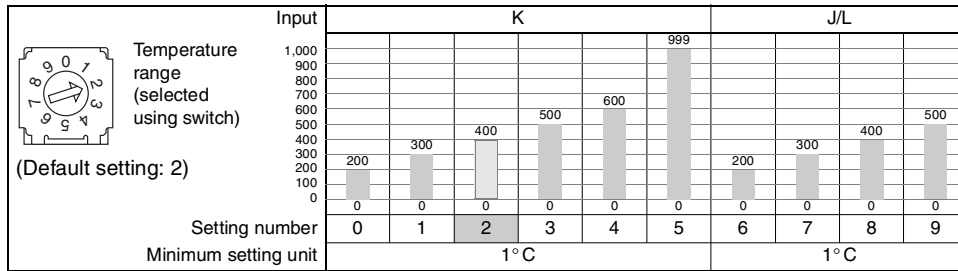

The shaded value indicates the default setting status.

Platinum Resistance Thermometer Input Models

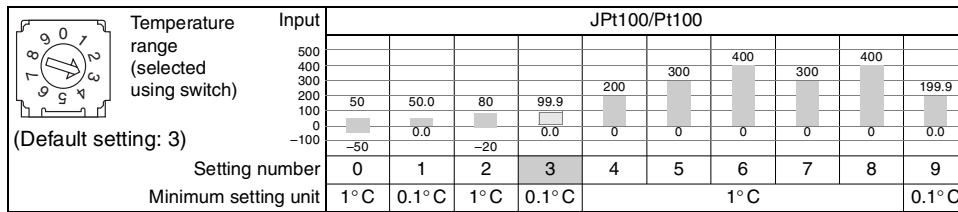

The shaded value indicates the default setting status.

Multi-input (Thermocouple/Platinum Resistance Thermometer) Models

• Using Thermocouple Sensors, Control Mode Switch 5: OFF

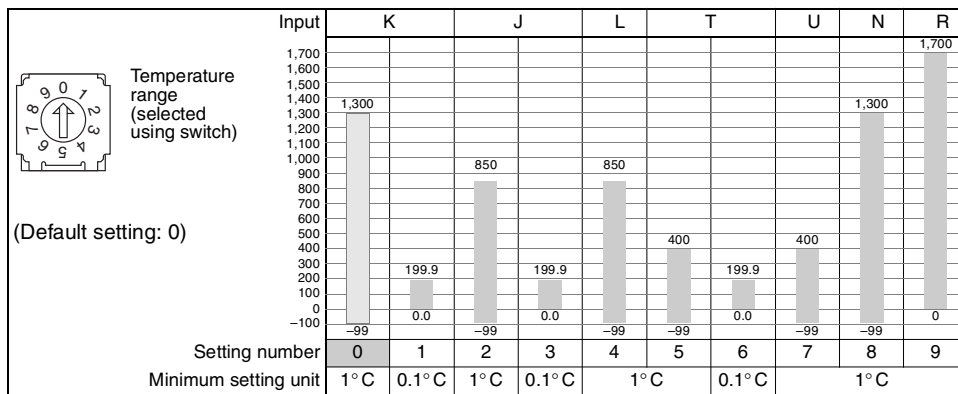

The shaded value indicates the default setting status.

• Using Platinum Resistance Thermometers, Control Mode Switch 5: ON

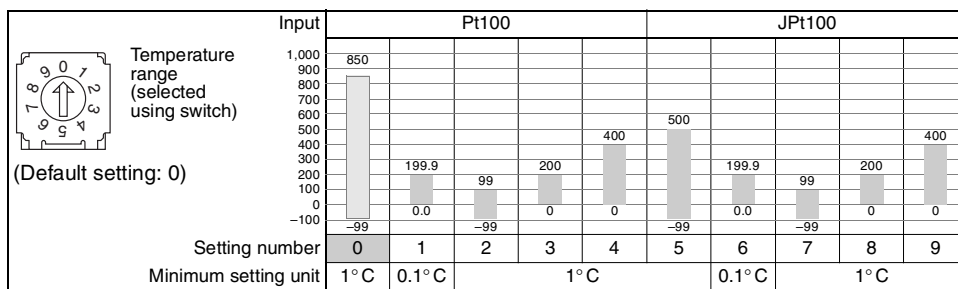

The shaded value indicates the default setting status.

External Connection Diagram

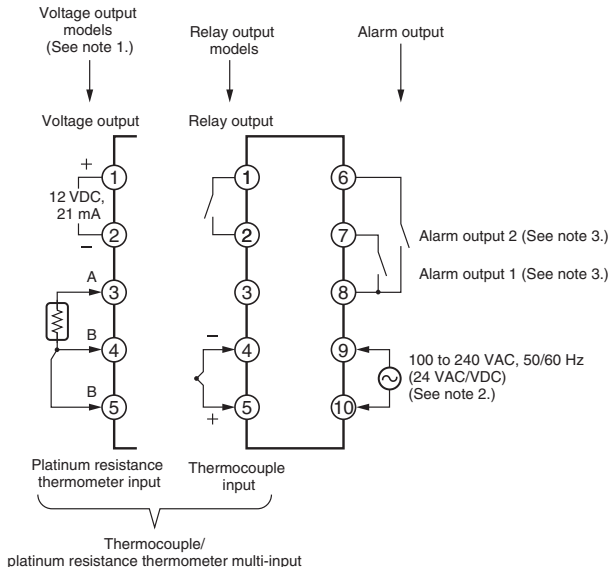

- Note:**
- 1. The voltage output (12 VDC, 21 mA) is not electrically isolated from the internal circuits. When using a grounding thermocouple, do not connect output terminals 1 or 2 to ground. Otherwise, unwanted current paths will cause measurement errors.
 - 2. Models with 100 to 240 VAC and 24 VAC/VDC are separate. Models using 24 VDC have no polarity.
 - 3. The number of alarm outputs depends on the model.

Nomenclature

E5CSV Models with Terminal Blocks

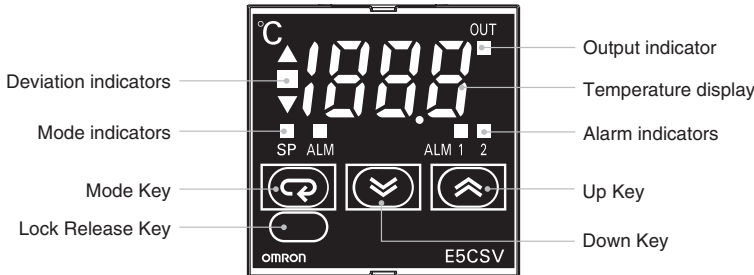

Operation

E5CSV

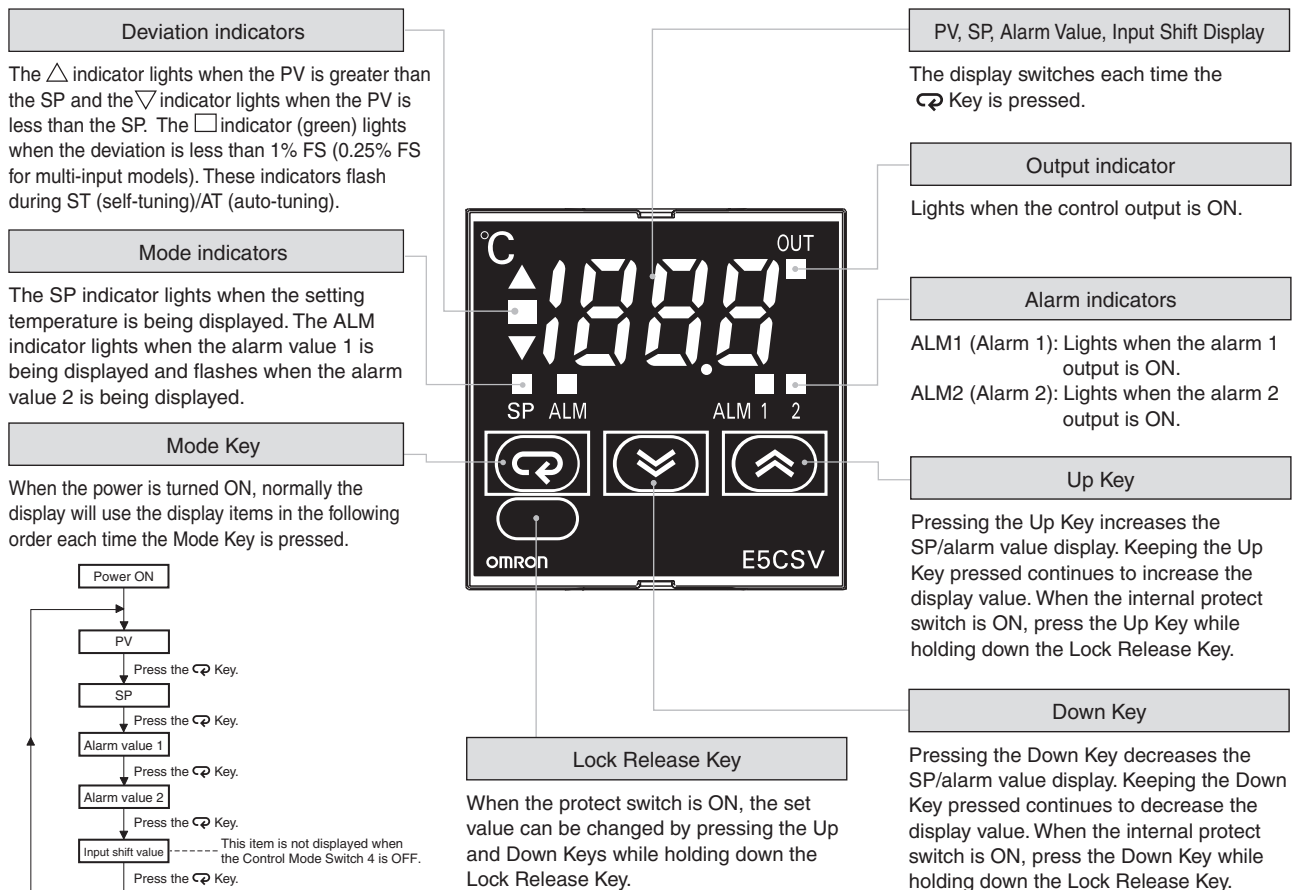

Settings before Turning ON the Power

E5CSV

Remove the E5CSV from the case to make the settings.

1. Insert the tool into the two tool insertion holes (one on the top and one on the bottom) and release the hooks.

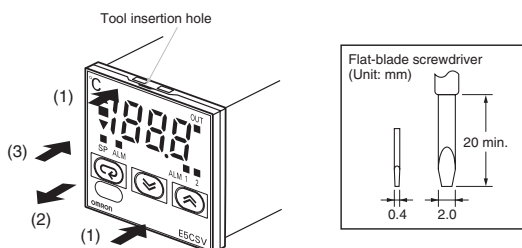

2. Insert the tool in the gap between the front panel and rear case, and pull out the front panel slightly. Grip the front panel and pull out fully. Be sure not to impose excessive force on the panel.

3. When inserting the E5CSV, check to make sure that the sealing rubber is in place and push the E5CSV toward the rear case until it snaps into position. While pushing the E5CSV into place, push down on the hooks on the top and bottom surfaces of the rear case so that the hooks are securely locked in place. Make sure that electronic components do not come into contact with the case.

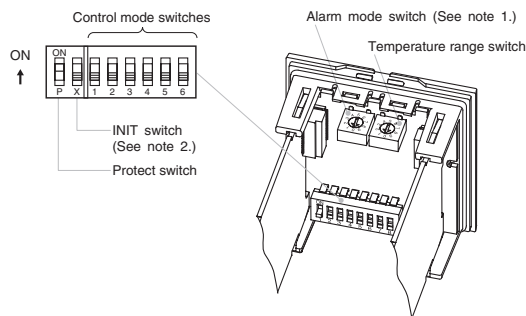

- Note:**
1. The alarm mode switch is not provided on models without alarms. Alarm 2 is always set to the upper limit in models with two alarms. A setting switch is not provided for alarm 2.
 2. The INIT switch is always OFF during normal operation.

1. Sensor Type Specification

Select the number on the temperature range switch to change the temperature range.

Thermocouple (The default is 2.)

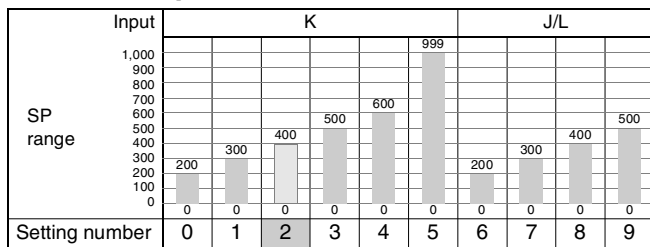

The control range is -10% to +10% FS for each temperature range.

Note: The input indication range is the range that can be displayed for the control range (-99 to 1999). If the input is within the control range but exceeds the display range (-99 to 1999), values below -99 will be displayed as "ccc" and values above 1,999 will be displayed as "kkk".

Platinum Resistance Thermometer

(The default is 3.)

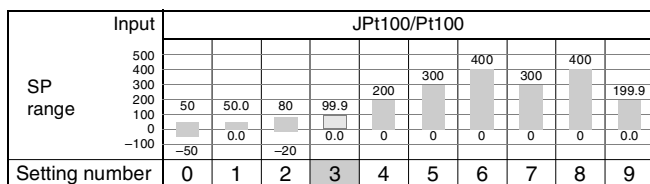

The control range is -10% to +10% FS for each temperature range.

Note: 1. The input indication range is the range that can be displayed for the control range (-99 to 1999). If the input is within the control range but exceeds the display range (-99 to 1999), values below -99 will be displayed as "ccc" and values above 1,999 will be displayed as "kkk".
 2. If the unit is changed to 1 degree when the SP and alarm value for the temperature range are displayed in 0.1-units from 0.0 to 199.9 or 0.0 to 99.9, the values will be multiplied by 10 (e.g., 0.5 becomes 5). If the unit is changed in the reverse direction, the values will be divided by 10. After changing the range, set the SP and alarm value again.
 3. The temperature range for setting numbers 5 and 6 are the same as for 7 and 8, respectively.

Multi-input (Thermocouple/Platinum Resistance Thermometer) Models

Using Thermocouple Sensors, Control Mode Switch 5: OFF

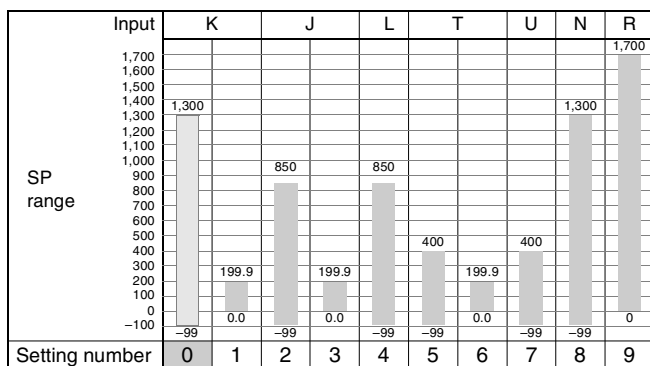

The control range is -20° C to +20° C of the input temperature range.

Note: 1. The input indication range is the range that can be displayed for the control range (-99 to 1999). If the input is within the control range but exceeds the display range (-99 to 1999), values below -99 will be displayed as "ccc" and values above 1,999 will be displayed as "kkk".

2. If unit is changed to 1 degree when the SP and alarm value for the temperature range are displayed in 0.1-units from 0.0 to 199.9 or 0.0 to 99.9, the values will be multiplied by 10 (e.g., 0.5 becomes 5). If the unit is changed in the reverse direction, the values will be divided by 10. After changing the range, set the SP and alarm value again.

- Using Platinum Resistance Thermometers, Control Mode Switch 5: ON

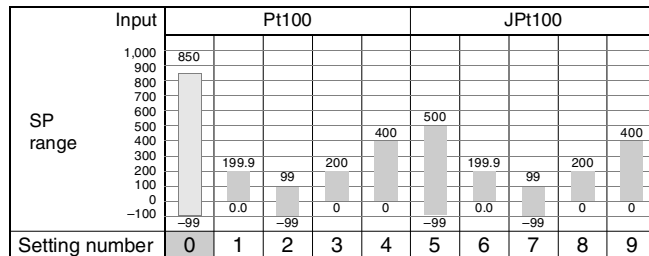

The control range is -20° C to +20° C of the input temperature range.

Note: 1. The input indication range is the range that can be displayed for the control range (-99 to 1999). If the input is within the control range but exceeds the display range (-99 to 1999), values below -99 will be displayed as "ccc" and values above 1,999 will be displayed as "kkk".
 2. If unit is changed to 1 degree when the SP and alarm value for the temperature range are displayed in 0.1-units from 0.0 to 199.9 or 0.0 to 99.9, the values will be multiplied by 10 (e.g., 0.5 becomes 5). If the unit is changed in the reverse direction, the values will be divided by 10. After changing the range, set the SP and alarm value again.

Mode Key Display Order

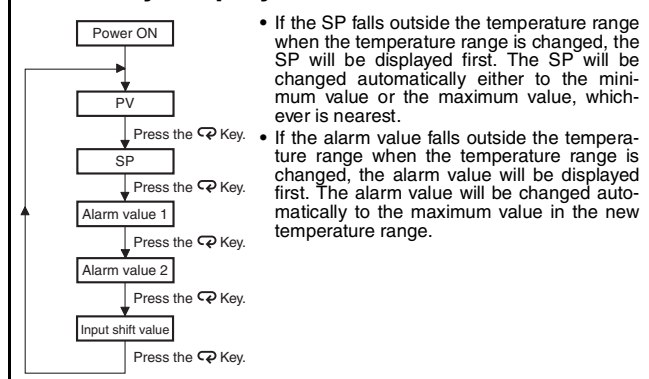

2. Operation Settings

Use the control mode switches () to change the control mode. (All switches are OFF for the default settings.)



Function selection		1	2	3	4	5	6	
ON/OFF PID	PID control	ON						
	ON/OFF control	OFF						
Control period	2 s		ON					
	20 s		OFF					
Direct/reverse operation	Direct operation (cooling)			ON				
	Reverse operation (heating)			OFF				
Input shift display	Enabled				ON			
	Disabled				OFF			
Temperature Sensor selection	Thermocouple	K, L				ON		
		K, J				OFF		
	Platinum resistance thermometer	Pt100					ON	
		JPt100					OFF	
	Multi-input (thermocouple/platinum resistance thermometer)	Platinum resistance thermometer input					ON	
Thermocouple input						OFF		
Temperature unit	° F						ON	
	° C						OFF	





Note: The previous name Pt100 has been changed to JPt100 in accordance with revisions to JIS. The previous name J-DIN has been changed to L in accordance with revisions to DIN standards.

Note: Turn OFF the power before changing the DIP switch settings on the E5CSV. Each of the switch settings will be enabled after the power is turned ON.

For details on the position of the temperature range switch, control mode switches, and alarm mode switch, refer to page 6.

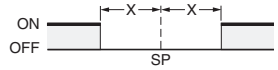
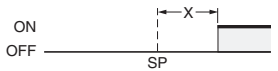
3. Alarm Modes

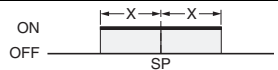
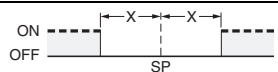
Select the number of the alarm mode switch () when changing the alarm mode. (The default is 2).

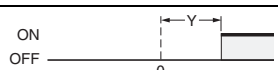
Set value	Alarm type	Alarm output operation
0, 9	Alarm function OFF	OFF
1	Upper- and lower-limit	
2	Upper-limit	
3	Lower-limit	
4	Upper- and lower-limit range	
5	Upper- and lower-limit with standby sequence (See note 2.)	
6	Upper-limit with standby sequence (See note 2.)	
7	Lower-limit with standby sequence (See note 2.)	
8	Absolute-value upper-limit	

Note: 1. No alarm. The alarm value (alarm operation display) will not be displayed when the setting is 0 or 9 even if the selection key is pressed.
Alarm Setting Range
X: 0 to FS (full scale); Y: Within temperature range
The value of X is the deviation setting for the SP (set point).

2. Standby Sequence Function (The standby sequence operates when the power is turned ON.)

Rising Temperature

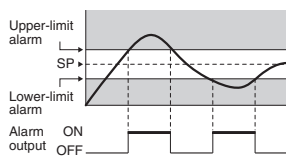

Dropping Temperature

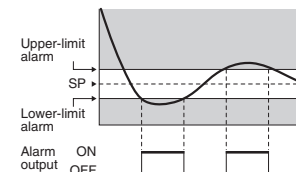

4. Using the Control Mode Switches

(1) Using ON/OFF Control and PID Control

ON/OFF Control

The control mode is set to ON/OFF control as the default setting.

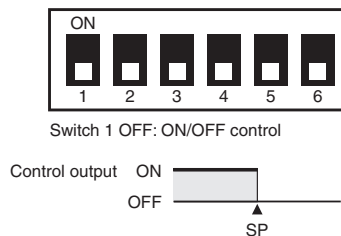

To perform cooling control of freezers, etc., turn ON switch 3.

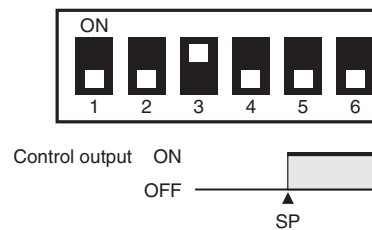

PID Control

Turn ON switch 1 to use PID control.



1. Set the control period.

Performing Control via Relay Output, External Relay, or Conductor

Switch 2: OFF (control period: 20 s)

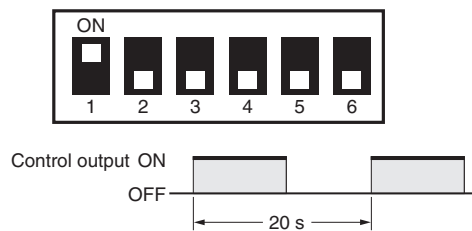

Quick Control Response Using an SSR

Switch 2: ON (control period: 2 s)

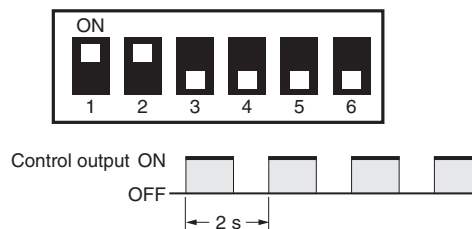

2. Set direct/reverse operation for the output.

Performing Heating Control for Heaters

Switch 3: OFF

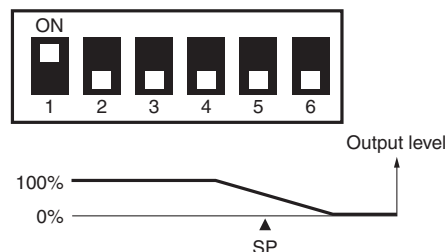

Performing Cooling Control for Freezers

Switch 3: ON

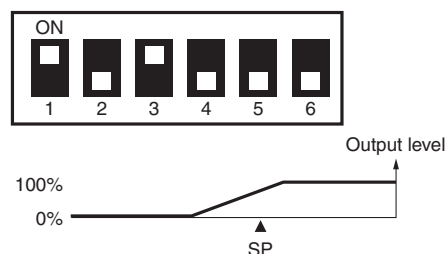

ST (Self-tuning) Features

ST (self-tuning) is a function that finds PID constants by using step response tuning (SRT) when Controller operation begins or when the set point is changed. Once the PID constants have been calculated, ST is not executed when the next control operation is started as long as the set point remains unchanged. When the ST function is in operation, be sure to turn ON the power supply of the load connected to the control output simultaneously with or before starting Controller operation.

Executing AT (Auto-tuning)

AT (auto-tuning) is executed by pressing the Up and Down Keys for at least 2 s while the PV is displayed. The deviation indicators flash during auto-tuning (AT) execution. AT will be cancelled by performing the same operation that AT is executing during AT operation. Flashing stops when AT is completed.

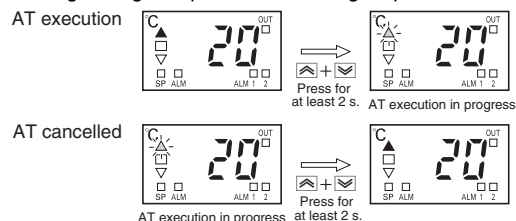

Note: One of the deviation indicators () will flash.

(2) Using the E5CSV in Devices for Fahrenheit-scale Users

(Displaying in °F)

Turn ON switch 6 to display temperatures in °F.



Temperature Range for °F

The temperature is set to °F using the same temperature range switch as °C.

Thermocouple

Set-ting		°F
0	K	0 to 200
1		0 to 300
2		0 to 400
3		0 to 500
4		0 to 600
5	J/L	0 to 999
6	J/L	0 to 300
7		0 to 400
8		0 to 500
9		0 to 500

Platinum Resistance Thermometer

Set-ting		°F
0	JPt100 or Pt100	-50 to 50
1		0.0 to 50.0
2		-20 to 80
3		0.0 to 99.9
4		0 to 200
5		0 to 300
6		0 to 400
7		0 to 600
9		0.0 to 199.9

Multi-input (Thermocouple/Platinum Resistance Thermometer)

Control mode switch 5: OFF

Set-ting		°F
0	K	-99 to 1999
1		0.0 to 199.9
2	J	-99 to 1500
3		0.0 to 199.9
4	L	-99 to 1500
5		0.0 to 199.9
6	T	-99 to 700
7		0.0 to 199.9
8	U	-99 to 700
9		0 to 1999

Multi-input (Thermocouple/Platinum Resistance Thermometer)

Control mode switch 5: ON

Set-ting		°F
0	Pt100	-99 to 1500
1		0.0 to 199.9
2		-99 to 99
3		0 to 200
4	JPt100	0 to 400
5		-99 to 900
6		0.0 to 199.9
7		-99 to 99
8		0 to 200
9	0 to 400	

Note: The control range for a thermocouple input or platinum resistance thermometer input is -10% to +10% FS for each temperature range. The control range for multi-input (thermocouple/platinum resistance thermometer) models is -40 to +40° F of each temperature range.

Using K, L/Pt100 Thermometers

Turn ON switch 5 when using K, L/Pt100 Thermometers.



Note: The previous name J-DIN has been changed to L in accordance with revisions to DIN standards.

(3) Setting Input Shift

Turn ON switch 4, and after turning ON the power, press the Mode Key until $H\bar{0}$ (indicates input shift of 0) is displayed. Press the Up and Down Keys to set the shift value.



Shift Example

Input shift display	Measured temperature	Temperature display
$H\bar{0}$ (no shift)	100° C	100° C
$H\bar{9}$ (+9° C shift)	100° C	109° C
$L\bar{9}$ (-9° C shift)	100° C	91° C

Note: When control mode switch 4 is turned OFF (no input shift display), the input shift is not displayed but the shift value is enabled. To disable input shift, set the input shift value to $H\bar{0}$. The shift range depends on the setting unit.

Setting unit	1° C	0.1° C
Compensation range	-99 to +99° C	-9.9 to +9.9° C
Input shift display	L99 to H99	L9.9 to H9.9

5. Protect Switch

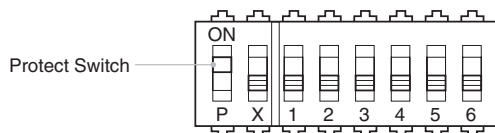

When the protect switch is ON, Up Key and Down Key operations are prohibited to prevent setting mistakes.

Installation

- All models in the E5CSV Series conform to DIN 43700 standards.
- The recommended panel thickness is 1 to 4 mm.
- Be sure to mount the E5CSV horizontally.

Mounting the E5CSV

1. For waterproof mounting, waterproof packing must be installed on the Controller. Waterproofing is not possible when group mounting several Controllers.
2. Insert the E5CSV into the mounting hole in the panel.
3. Push the adapter from the terminals up to the panel, and temporarily fasten the E5CSV.
4. Tighten the two fastening screws on the adapter. Alternately tighten the two screws little by little to maintain a balance. Tighten the screws to a torque of 0.29 to 0.39 N·m.

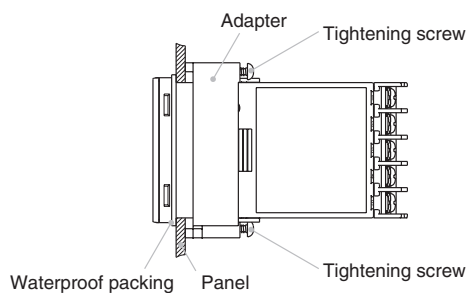

Error Displays and Causes

In addition to the alarm indicator, errors notification is provided on the display. Be sure to remove the cause of the error promptly.

Display status	Cause	Control output
PV displayed as <i>FFF</i>	The process value is higher than the control temperature range (overflow).	Heating control (reverse operation): OFF Cooling control (direct operation): ON
PV displayed as ---	The process value is lower than the control temperature range (underflow).	Heating control (reverse operation): ON Cooling control (direct operation): OFF
<i>FFF</i> flashing	(1) Thermocouple models and platinum resistance thermometer models: The process value is higher than the overflow temperature, or a Sensor error has occurred. (2) Multi-input (Thermocouple/platinum resistance thermometer) models: The process value is higher than the control temperature range or a Sensor error has occurred.	OFF
--- flashing	(1) Thermocouple and platinum resistance thermometer input: The process value is lower than the underflow temperature, or a Sensor error has occurred. (2) Thermocouples: The polarity is reversed. (3) Multi-input (Thermocouple/platinum resistance thermometer) models: The process value is lower than the control temperature range or a Sensor error has occurred.	OFF
<i>E 11</i> is displayed	A memory error (E11) has occurred. Turn the power ON again. If the display remains the same, the Controller must be repaired.	The control outputs and alarm outputs turn OFF.

Note: In models with an alarm, *FFF* appears or flashes on the display to indicate that the temperature has exceeded the maximum display temperature and the output is set according to the alarm mode. In the same way, --- appears or flashes on the display to indicate that the temperature has exceeded the minimum display temperature and the output is set according to the alarm mode.

Sensor Error Displays and Causes

■ Thermocouple

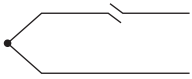
Status	Display	Control output
Burnout 	<i>FFF</i> flashing	OFF

Note: The room temperature is displayed if an input short-circuit occurs.

■ Platinum Resistance Thermometer

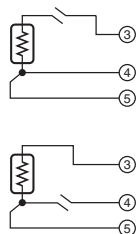
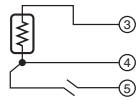
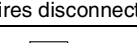
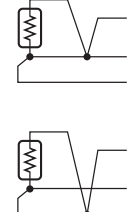
Status	Display	Control output
Burnout 	<i>FFF</i> flashing	OFF
	--- flashing	OFF
2 or 3 wires disconnected 	<i>FFF</i> flashing	OFF
Short-circuit 	--- flashing	OFF

Note: The resistance value for platinum resistance thermometers is 100 Ω at 0°C and 140 Ω at 100°C.

Comparison with E5CS-X

Model Number Legend

Previous model				E5CSV			
E5CS-□□□X 1 2 3				E5CSV-□□□□-□ 1 2 3 4 5			
	Classification	Symbol	Meaning		Classification	Symbol	Meaning
1	Control output	R Q	Relay: SPDT (single-pole, double-throw) Voltage	1	Control output	R Q	Relay: SPST-NO (single-pole, single-throw, normally open) Voltage
2	Alarm output	Blank 1	No alarms One alarm	2	Alarm output	Blank 1 2	No alarms One alarm Two alarms
3	Input type	KJ P	Thermocouple (K, J) Platinum resistance thermometer (Pt100, JPt100)	3	Input type	T KJ P	Multi-input (thermocouple/platinum resistance thermometer) models Thermocouple (K, J) Platinum resistance thermometer (Pt100, JPt100)
	Terminal appearance	X	Model with terminal block	4	Supply specifications	Blank D	100 to 240 VAC 24 VAC/VDC
				5	Case color	Blank W F	Black Light gray Scale marked in F° (Black case only)

Main Differences
 Terminal block models use the model number E5CSV.
 The suffix "D" is added to models with a supply voltage of 24 VAC/VDC.
 The suffix "W" is added to models with a light gray case color.

Display

Previous model	E5CSV

The display digits can be increased up to 1,999.
 The ALM2 display has been added.
 The display "ON" has changed to "OUT" and "AL" has changed to "ALM."

Functions

The control outputs for relay outputs have been changed from SPDT (single-pole, double-throw) to SPST-NO (single-pole, single-throw, normally open) contacts.
 The control method has been changed to 2-PID control.
 An auto-tuning (AT) function has been added.
 The deviation display flashes during self-tuning (ST) and auto-tuning (AT).
 The control calculation period has been improved from 2 s to 0.5 s.

External Dimensions

The depth has been shortened from 100 mm to 76 mm.

Terminal Arrangement

- The terminal arrangement has changed from a horizontal to vertical configuration.

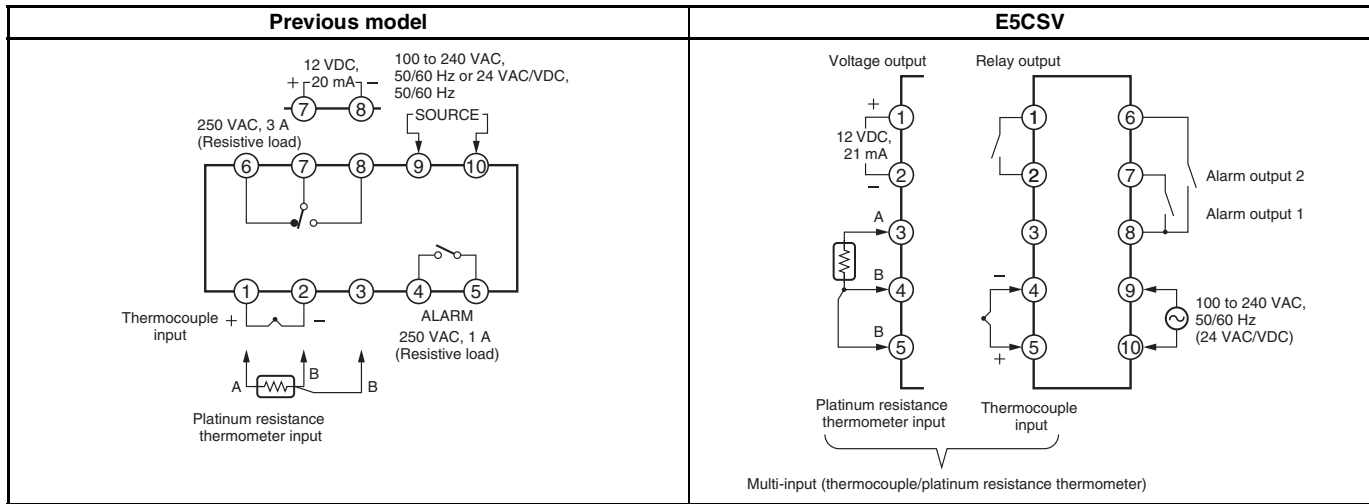

DIP Switch and Rotary Switch Setting Methods

No change from previous models.

Dimensions

Note: All units are in millimeters unless otherwise indicated.

Controller

E5CSV

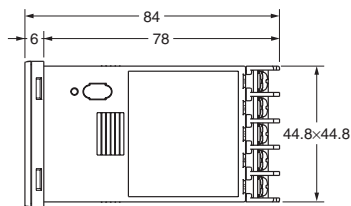
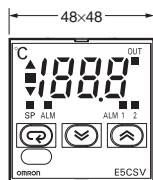
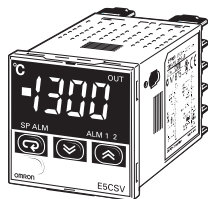

Panel Cutout Dimensions

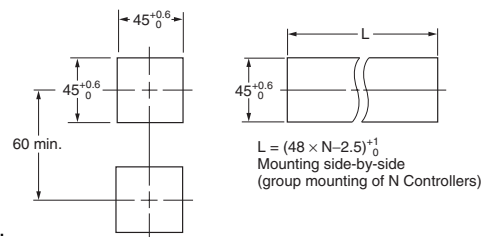

Note: Terminals cannot be removed.

E5CSV + Adapter for Flush Mounting (Provided)

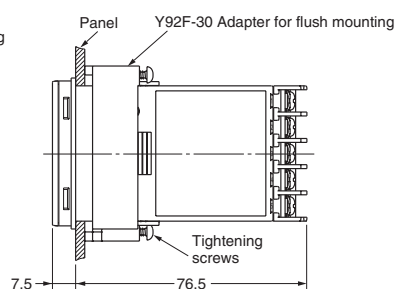
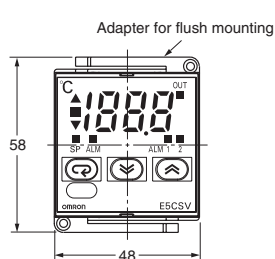
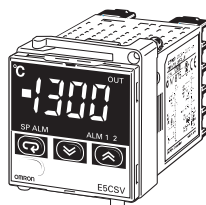
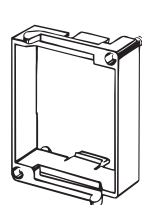

- Note: 1. The recommended panel thickness is 1 to 4 mm.
2. Group mounting is possible in one direction only.

Hard Protective Cover

The Y92A-48B Protective Cover (hard type) is available for the following applications.

- To protect the set from dust and dirt.
- To prevent the panel from being accidentally touched causing displacement of set values.
- To provide effective protection against water droplets.

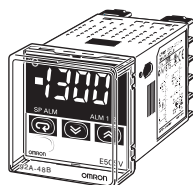

Terminal Cover

E53-COV10

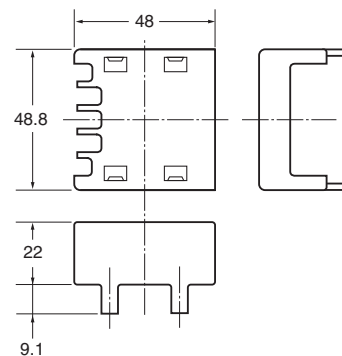
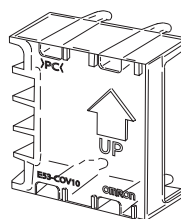

Precautions

 **Caution**

Do not touch the terminals while power is being supplied. Doing so may occasionally result in minor injury due to electric shock.



Do not allow pieces of metal, wire clippings, or fine metallic shavings or filings from installation to enter the product. Doing so may occasionally result in electric shock, fire, or malfunction.



Do not use the product where subject to flammable or explosive gas. Otherwise, minor injury from explosion may occasionally occur.



Never disassemble, modify, or repair the product or touch any of the internal parts. Minor electric shock, fire, or malfunction may occasionally occur.



CAUTION - Risk of Fire and Electric Shock

- a) This product is UL listed as Open Type Process Control Equipment. It must be mounted in an enclosure that does not allow fire to escape externally.
- b) More than one disconnect switch may be required to de-energize the equipment before servicing the product.
- c) Signal inputs are SELV, limited energy. (See note 1.)
- d) Caution: To reduce the risk of fire or electric shock, do not interconnect the outputs of different Class 2 circuits. (See note 2.)



If the output relays are used past their life expectancy, contact fusing or burning may occasionally occur. Always consider the application conditions and use the output relays within their rated load and electrical life expectancy. The life expectancy of output relays varies considerably with the output load and switching conditions.



Loose screws may occasionally result in fire. Tighten terminal screws to the specified torque of 0.74 to 0.90 N·m.



Unexpected operation may result in equipment damage or accidents if the settings are not appropriate for the controlled system. Set the Temperature Controller as follows:

- Set the parameters of the Temperature Controller so that they are appropriate for the controlled system.
- Turn the power supply to the Temperature Controller OFF before changing any switch setting. Switch settings are read only when the power supply is turned ON.
- Make sure that the INIT switch in the control mode switches is turned OFF before operating the Temperature Controller.



A malfunction in the Temperature Controller may occasionally make control operations impossible or prevent alarm outputs, resulting in property damage. To maintain safety in the event of malfunction of the Temperature Controller, take appropriate safety measures, such as installing a monitoring device on a separate line.



Faulty terminal contact or decreased waterproofing capability may result in a fire or equipment malfunction. When inserting the Temperature Controller into the rear case after setting the switches, check the watertight packing and make sure that the top and bottom hooks are locked securely in place.



- Note:**
1. A SELV circuit is one separated from the power supply with double insulation or reinforced insulation, that does not exceed 30 V r.m.s. and 42.4 V peak or 60 VDC.
 2. A class 2 power supply is one tested and certified by UL as having the current and voltage of the secondary output restricted to specific levels.

■ Precautions for Safe Use

Be sure to observe the following precautions to prevent operation failure, malfunction, or adverse affects on the performance and functions of the product. Not doing so may occasionally result in unexpected events.

1. The product is designed for indoor use only. Do not use the product outdoors or in any of the following locations.
 - Places directly subject to heat radiated from heating equipment.
 - Places subject to splashing liquid or oil atmosphere.
 - Places subject to direct sunlight.
 - Places subject to dust or corrosive gas (in particular, sulfide gas and ammonia gas).
 - Places subject to intense temperature change.
 - Places subject to icing and condensation.
 - Places subject to vibration and large shocks.
2. Use and store the product within the rated temperature and humidity ranges. Group-mounting two or more Temperature Controllers, or mounting Temperature Controllers above each other may cause heat to build up inside the Temperature Controllers, which will shorten their service life. In such a case, use forced cooling by fans or other means of air ventilation to cool down the Temperature Controllers.
3. To allow heat to escape, do not block the area around the product. Do not block the ventilation holes on the product.
4. Use the specified size (M3.5, width of 7.2 mm or less) crimped terminals for wiring. To connect bare wires to the terminal block, use copper braided or solid wires with a gage of AWG24 to AWG18 (equal to a cross-sectional area of 0.205 to 0.832 mm²). (The stripping length is 5 to 6 mm.) Up to two wires of the same size and type, or two crimp terminals can be inserted into a single terminal.
5. Be sure to wire properly with correct polarity of terminals. Do not wire any of the I/O terminals incorrectly.
6. Do not wire the terminals that are not used.
7. The voltage output (control output) is not electrically isolated from the internal circuits. When using a grounded temperature sensor, do not connect any of the control output terminals to ground. Otherwise unwanted current paths will cause measurement errors.
8. To avoid inductive noise, keep the wiring for the Temperature Controller's terminal block away from power cables carrying high voltages or large currents. Also, do not wire power lines together with or parallel to Temperature Controller wiring. Using shielded cables and using separate conduits or ducts is recommended. Attach a surge suppressor or noise filter to peripheral devices that generate noise (in particular, motors, transformers, solenoids, magnetic coils or other equipment that have an inductance component). When a noise filter is used at the power supply, first check the voltage or current, and attach the noise filter as close as possible to the temperature controller. Allow as much space as possible between the Temperature Controller and devices that generate powerful high frequencies (high-frequency welders, high-frequency sewing machines, etc.) or surge.

9. Use the product within the rated load and power supply.
10. Use a switch, relay, or other contact so that the power supply voltage reaches the rated voltage within 2 seconds. If the applied voltage is increased gradually, the power supply may not be reset or malfunctions may occur.
11. When using PID operation (self-tuning), turn ON the power supply to the load (e.g., heater) at the same time or before turning the power supply to the Temperature Controller ON. If power is turned ON for the Temperature Controller before turning ON power supply to the load, self-tuning will not be performed properly and optimum control will not be achieved.
12. Design the system (e.g., control panel) to allow for the 2 seconds of delay required for the Temperature Controller's output to stabilize after the power is turned ON.
13. A switch or circuit breaker should be provided close to this unit. The switch or circuit breaker should be within easy reach of the operator, and must be marked as a disconnecting means for this unit.
14. Approximately 30 minutes is required for the correct temperature to be displayed after turning the power supply to the Temperature Controller ON. Turn the power supply ON at least 30 minutes prior to starting control operations.
15. Be sure that the platinum resistance thermometer type and the input type set on the Temperature Controller are the same.
16. When extending the thermocouple lead wires, always use compensating conductors suitable for the type of thermocouple. Do not extend the lead wires on a platinum resistance thermometer. Use only low-resistance wire (5 Ω max. per line) for lead wires and make sure that the resistance is the same for all three wires.
17. When drawing out the Temperature Controller from the case, do not apply force that would deform or alter the Temperature Controller.
18. When drawing out the Temperature Controller from the case to replace the Temperature Controller, check the status of the terminals. If corroded terminals are used, contact faults with the terminals may cause the temperature inside the Temperature Controller to increase, possibly resulting in fire. If the terminals are corroded, replace the rear case as well.
19. When drawing out the Temperature Controller from the case, turn the power supply OFF first, and absolutely do not touch the terminals or electronic components or apply shock to them. When inserting the Temperature Controller, do not allow the electronic components to come into contact with the case.
20. Static electricity may damage internal components. Always touch grounded metal to discharge any static electricity before handling the Temperature Controller. When drawing out the Temperature Controller from the case, do not touch the electronic components or patterns on the board with your hand. Hold the Temperature Controller by the edge of the front panel when handling it.
21. Do not use paint thinner or similar chemical to clean with. Use standard grade alcohol.
22. Use tools when separating parts for disposal. Contact with the sharp internal parts may cause injury.

■ Precautions for Correct Use

Service Life

Use the Temperature Controller within the following temperature and humidity ranges:

Temperature:	-10 to 55°C (with no icing or condensation)
Humidity:	25% to 85%

If the Controller is installed inside a control board, the ambient temperature must be kept to under 55°C, including the temperature around the Controller.

The service life of electronic devices like Temperature Controllers is determined not only by the number of times the relay is switched but also by the service life of internal electronic components. Component service life is affected by the ambient temperature: the higher the temperature, the shorter the service life and, the lower the temperature, the longer the service life. Therefore, the service life can be extended by lowering the temperature of the Temperature Controller.

When two or more Temperature Controllers are mounted horizontally close to each other or vertically next to one another, the internal temperature will increase due to heat radiated by the Temperature Controllers and the service life will decrease. In such a case, use forced cooling by fans or other means of air ventilation to cool down the Temperature Controllers. When providing forced cooling, however, be careful not to cool down the terminals sections alone to avoid measurement errors.

Measurement Accuracy

When extending or connecting the thermocouple lead wire, be sure to use compensating wires that match the thermocouple type. Do not extend the lead wire of the platinum resistance thermometer. If the lead wire of the platinum resistance thermometer must be extended, be sure to use wires that have low resistance and keep the resistance of the three lead wires the same.

Mount the Temperature Controller so that it is horizontally level.

If the measurement accuracy is low, check whether the input shift has been set correctly.

Waterproofing

The degree of protection is as shown below. Sections without any specification on their degree of protection or those with IP□0 are not waterproof.

Front panel: IP66, rear case: IP20, terminals: IP00

Warranty and Application Considerations

Read and Understand this Catalog

Please read and understand this catalog before purchasing the products. Please consult your OMRON representative if you have any questions or comments.

Warranty and Limitations of Liability

WARRANTY

OMRON's exclusive warranty is that the products are free from defects in materials and workmanship for a period of one year (or other period if specified) from date of sale by OMRON.

OMRON MAKES NO WARRANTY OR REPRESENTATION, EXPRESS OR IMPLIED, REGARDING NON-INFRINGEMENT, MERCHANTABILITY, OR FITNESS FOR PARTICULAR PURPOSE OF THE PRODUCTS. ANY BUYER OR USER ACKNOWLEDGES THAT THE BUYER OR USER ALONE HAS DETERMINED THAT THE PRODUCTS WILL SUITABLY MEET THE REQUIREMENTS OF THEIR INTENDED USE. OMRON DISCLAIMS ALL OTHER WARRANTIES, EXPRESS OR IMPLIED.

LIMITATIONS OF LIABILITY

OMRON SHALL NOT BE RESPONSIBLE FOR SPECIAL, INDIRECT, OR CONSEQUENTIAL DAMAGES, LOSS OF PROFITS, OR COMMERCIAL LOSS IN ANY WAY CONNECTED WITH THE PRODUCTS, WHETHER SUCH CLAIM IS BASED ON CONTRACT, WARRANTY, NEGLIGENCE, OR STRICT LIABILITY.

In no event shall the responsibility of OMRON for any act exceed the individual price of the product on which liability is asserted.

IN NO EVENT SHALL OMRON BE RESPONSIBLE FOR WARRANTY, REPAIR, OR OTHER CLAIMS REGARDING THE PRODUCTS UNLESS OMRON'S ANALYSIS CONFIRMS THAT THE PRODUCTS WERE PROPERLY HANDLED, STORED, INSTALLED, AND MAINTAINED AND NOT SUBJECT TO CONTAMINATION, ABUSE, MISUSE, OR INAPPROPRIATE MODIFICATION OR REPAIR.

Application Considerations

SUITABILITY FOR USE

OMRON shall not be responsible for conformity with any standards, codes, or regulations that apply to the combination of products in the customer's application or use of the products.

Take all necessary steps to determine the suitability of the product for the systems, machines, and equipment with which it will be used.

Know and observe all prohibitions of use applicable to this product.

NEVER USE THE PRODUCTS FOR AN APPLICATION INVOLVING SERIOUS RISK TO LIFE OR PROPERTY WITHOUT ENSURING THAT THE SYSTEM AS A WHOLE HAS BEEN DESIGNED TO ADDRESS THE RISKS, AND THAT THE OMRON PRODUCTS ARE PROPERLY RATED AND INSTALLED FOR THE INTENDED USE WITHIN THE OVERALL EQUIPMENT OR SYSTEM.

Disclaimers

PERFORMANCE DATA

Performance data given in this catalog is provided as a guide for the user in determining suitability and does not constitute a warranty. It may represent the result of OMRON's test conditions, and the users must correlate it to actual application requirements. Actual performance is subject to the OMRON *Warranty and Limitations of Liability*.

CHANGE IN SPECIFICATIONS

Product specifications and accessories may be changed at any time based on improvements and other reasons. Consult with your OMRON representative at any time to confirm actual specifications of purchased product.

DIMENSIONS AND WEIGHTS

Dimensions and weights are nominal and are not to be used for manufacturing purposes, even when tolerances are shown.

Terms and Conditions of Sale

1. **Offer; Acceptance.** These terms and conditions (these "Terms") are deemed part of all quotes, agreements, purchase orders, acknowledgments, price lists, catalogs, manuals, brochures and other documents, whether electronic or in writing, relating to the sale of products or services (collectively, the "Products") by Omron Electronics LLC and its subsidiary companies ("Omron"). Omron objects to any terms or conditions proposed in Buyer's purchase order or other documents which are inconsistent with, or in addition to, these Terms.
2. **Prices; Payment Terms.** All prices stated are current, subject to change without notice by Omron. Omron reserves the right to increase or decrease prices on any unshipped portions of outstanding orders. Payments for Products are due net 30 days unless otherwise stated in the invoice.
3. **Discounts.** Cash discounts, if any, will apply only on the net amount of invoices sent to Buyer after deducting transportation charges, taxes and duties, and will be allowed only if (i) the invoice is paid according to Omron's payment terms and (ii) Buyer has no past due amounts.
4. **Interest.** Omron, at its option, may charge Buyer 1-1/2% interest per month or the maximum legal rate, whichever is less, on any balance not paid within the stated terms.
5. **Orders.** Omron will accept no order less than \$200 net billing.
6. **Governmental Approvals.** Buyer shall be responsible for, and shall bear all costs involved in, obtaining any government approvals required for the importation or sale of the Products.
7. **Taxes.** All taxes, duties and other governmental charges (other than general real property and income taxes), including any interest or penalties thereon, imposed directly or indirectly on Omron or required to be collected directly or indirectly by Omron for the manufacture, production, sale, delivery, importation, consumption or use of the Products sold hereunder (including customs duties and sales, excise, use, turnover and license taxes) shall be charged to and remitted by Buyer to Omron.
8. **Financial.** If the financial position of Buyer at any time becomes unsatisfactory to Omron, Omron reserves the right to stop shipments or require satisfactory security or payment in advance. If Buyer fails to make payment or otherwise comply with these Terms or any related agreement, Omron may (without liability and in addition to other remedies) cancel any unshipped portion of Products sold hereunder and stop any Products in transit until Buyer pays all amounts, including amounts payable hereunder, whether or not then due, which are owing to it by Buyer. Buyer shall in any event remain liable for all unpaid accounts.
9. **Cancellation; Etc.** Orders are not subject to rescheduling or cancellation unless Buyer indemnifies Omron against all related costs or expenses.
10. **Force Majeure.** Omron shall not be liable for any delay or failure in delivery resulting from causes beyond its control, including earthquakes, fires, floods, strikes or other labor disputes, shortage of labor or materials, accidents to machinery, acts of sabotage, riots, delay in or lack of transportation or the requirements of any government authority.
11. **Shipping; Delivery.** Unless otherwise expressly agreed in writing by Omron:
 - a. Shipments shall be by a carrier selected by Omron; Omron will not drop ship except in "break down" situations.
 - b. Such carrier shall act as the agent of Buyer and delivery to such carrier shall constitute delivery to Buyer;
 - c. All sales and shipments of Products shall be FOB shipping point (unless otherwise stated in writing by Omron), at which point title and risk of loss shall pass from Omron to Buyer; provided that Omron shall retain a security interest in the Products until the full purchase price is paid;
 - d. Delivery and shipping dates are estimates only; and
 - e. Omron will package Products as it deems proper for protection against normal handling and extra charges apply to special conditions.
12. **Claims.** Any claim by Buyer against Omron for shortage or damage to the Products occurring before delivery to the carrier must be presented in writing to Omron within 30 days of receipt of shipment and include the original transportation bill signed by the carrier noting that the carrier received the Products from Omron in the condition claimed.
13. **Warranties.** (a) **Exclusive Warranty.** Omron's exclusive warranty is that the Products will be free from defects in materials and workmanship for a period of twelve months from the date of sale by Omron (or such other period expressed in writing by Omron). Omron disclaims all other warranties, express or implied. (b) **Limitations.** OMRON MAKES NO WARRANTY OR REPRESENTATION, EXPRESS OR IMPLIED, ABOUT NON-INFRINGEMENT, MERCHANTABILITY OR FITNESS FOR A PARTICULAR PURPOSE OF THE PRODUCTS. BUYER ACKNOWLEDGES THAT IT ALONE HAS DETERMINED THAT THE PRODUCTS WILL SUITABLY MEET THE REQUIREMENTS OF THEIR INTENDED USE. Omron further disclaims all warranties and responsibility of any type for claims or expenses based on infringement by the Products or otherwise of any intellectual property right. (c) **Buyer Remedy.** Omron's sole obligation hereunder shall be, at Omron's election, to (i) replace (in the form originally shipped with Buyer responsible for labor charges for removal or replacement thereof) the non-complying Product, (ii) repair the non-complying Product, or (iii) repay or credit Buyer an amount equal to the purchase price of the non-complying Product; provided that in no event shall Omron be responsible for warranty, repair, indemnity or any other claims or expenses regarding the Products unless Omron's analysis confirms that the Products were properly handled, stored, installed and maintained and not subject to contamination, abuse, misuse or inappropriate modification. Return of any Products by Buyer must be approved in writing by Omron before shipment. Omron Companies shall not be liable for the suitability or unsuitability or the results from the use of Products in combination with any electrical or electronic components, circuits, system assemblies or any other materials or substances or environments. Any advice, recommendations or information given orally or in writing, are not to be construed as an amendment or addition to the above warranty. See <http://www.omron247.com> or contact your Omron representative for published information.
14. **Limitation on Liability; Etc.** OMRON COMPANIES SHALL NOT BE LIABLE FOR SPECIAL, INDIRECT, INCIDENTAL, OR CONSEQUENTIAL DAMAGES, LOSS OF PROFITS OR PRODUCTION OR COMMERCIAL LOSS IN ANY WAY CONNECTED WITH THE PRODUCTS, WHETHER SUCH CLAIM IS BASED IN CONTRACT, WARRANTY, NEGLIGENCE OR STRICT LIABILITY. Further, in no event shall liability of Omron Companies exceed the individual price of the Product on which liability is asserted.
15. **Indemnities.** Buyer shall indemnify and hold harmless Omron Companies and their employees from and against all liabilities, losses, claims, costs and expenses (including attorney's fees and expenses) related to any claim, investigation, litigation or proceeding (whether or not Omron is a party) which arises or is alleged to arise from Buyer's acts or omissions under these Terms or in any way with respect to the Products. Without limiting the foregoing, Buyer (at its own expense) shall indemnify and hold harmless Omron and defend or settle any action brought against such Companies to the extent based on a claim that any Product made to Buyer specifications infringed intellectual property rights of another party.
16. **Property; Confidentiality.** Any intellectual property in the Products is the exclusive property of Omron Companies and Buyer shall not attempt to duplicate it in any way without the written permission of Omron. Notwithstanding any charges to Buyer for engineering or tooling, all engineering and tooling shall remain the exclusive property of Omron. All information and materials supplied by Omron to Buyer relating to the Products are confidential and proprietary, and Buyer shall limit distribution thereof to its trusted employees and strictly prevent disclosure to any third party.
17. **Export Controls.** Buyer shall comply with all applicable laws, regulations and licenses regarding (i) export of products or information; (ii) sale of products to "forbidden" or other proscribed persons; and (iii) disclosure to non-citizens of regulated technology or information.
18. **Miscellaneous.** (a) **Waiver.** No failure or delay by Omron in exercising any right and no course of dealing between Buyer and Omron shall operate as a waiver of rights by Omron. (b) **Assignment.** Buyer may not assign its rights hereunder without Omron's written consent. (c) **Law.** These Terms are governed by the law of the jurisdiction of the home office of the Omron company from which Buyer is purchasing the Products (without regard to conflict of law principles). (d) **Amendment.** These Terms constitute the entire agreement between Buyer and Omron relating to the Products, and no provision may be changed or waived unless in writing signed by the parties. (e) **Severability.** If any provision hereof is rendered ineffective or invalid, such provision shall not invalidate any other provision. (f) **Setoff.** Buyer shall have no right to set off any amounts against the amount owing in respect of this invoice. (g) **Definitions.** As used herein, "including" means "including without limitation"; and "Omron Companies" (or similar words) mean Omron Corporation and any direct or indirect subsidiary or affiliate thereof.

Certain Precautions on Specifications and Use

1. **Suitability of Use.** Omron Companies shall not be responsible for conformity with any standards, codes or regulations which apply to the combination of the Product in the Buyer's application or use of the Product. At Buyer's request, Omron will provide applicable third party certification documents identifying ratings and limitations of use which apply to the Product. This information by itself is not sufficient for a complete determination of the suitability of the Product in combination with the end product, machine, system, or other application or use. Buyer shall be solely responsible for determining appropriateness of the particular Product with respect to Buyer's application, product or system. Buyer shall take application responsibility in all cases but the following is a non-exhaustive list of applications for which particular attention must be given: (i) Outdoor use, uses involving potential chemical contamination or electrical interference, or conditions or uses not described in this document. (ii) Use in consumer products or any use in significant quantities. (iii) Energy control systems, combustion systems, railroad systems, aviation systems, medical equipment, amusement machines, vehicles, safety equipment, and installations subject to separate industry or government regulations. (iv) Systems, machines and equipment that could present a risk to life or property. Please know and observe all prohibitions of use applicable to this Product. NEVER USE THE PRODUCT FOR AN APPLICATION INVOLVING SERIOUS RISK TO LIFE OR PROPERTY OR IN LARGE QUANTITIES WITHOUT ENSURING THAT THE SYSTEM AS A WHOLE HAS BEEN DESIGNED TO ADDRESS THE RISKS, AND THAT THE OMRON'S PRODUCT IS PROPERLY RATED AND INSTALLED FOR THE INTENDED USE WITHIN THE OVERALL EQUIPMENT OR SYSTEM.
2. **Programmable Products.** Omron Companies shall not be responsible for the user's programming of a programmable Product, or any consequence thereof.
3. **Performance Data.** Data presented in Omron Company websites, catalogs and other materials is provided as a guide for the user in determining suitability and does not constitute a warranty. It may represent the result of Omron's test conditions, and the user must correlate it to actual application requirements. Actual performance is subject to the Omron's Warranty and Limitations of Liability.
4. **Change in Specifications.** Product specifications and accessories may be changed at any time based on improvements and other reasons. It is our practice to change part numbers when published ratings or features are changed, or when significant construction changes are made. However, some specifications of the Product may be changed without any notice. When in doubt, special part numbers may be assigned to fix or establish key specifications for your application. Please consult with your Omron's representative at any time to confirm actual specifications of purchased Product.
5. **Errors and Omissions.** Information presented by Omron Companies has been checked and is believed to be accurate; however, no responsibility is assumed for clerical, typographical or proofreading errors or omissions.

Complete "Terms and Conditions of Sale" for product purchase and use are on Omron's website at www.omron.com/oei – under the "About Us" tab, in the Legal Matters section.

ALL DIMENSIONS SHOWN ARE IN MILLIMETERS.

To convert millimeters into inches, multiply by 0.03937. To convert grams into ounces, multiply by 0.03527.

OMRON[®]**OMRON ELECTRONICS LLC**

1 Commerce Drive
Schaumburg, IL 60173
Tel: 847.843.7900

For U.S. technical support or other inquiries: 800.556.6766

OMRON CANADA, INC.

885 Milner Avenue
Toronto, Ontario M1B 5V8
Tel: 416.286.6465

MEXICO SALES OFFICES

Mexico, D.F. (52) 555 660 31 44
Ciudad Juárez (52) 656 623 70 83
Monterrey, N.L. (52) 818 377 42 81
Mexicali, B.C. (52) 686 838 01 15

BRAZIL SALES OFFICES

Sao Paulo (55) 11 2101 6300

ARGENTINA SALES OFFICES

Cono Sur (54) 11 4787 1129

CHILE SALES OFFICES

Santiago (56) 2206 4592

OTHER LATIN AMERICAN SALES

mela@omron.com

OMRON ON-LINE

Global –
www.omron.com

USA –
www.omron247.com

Canada –
www.omron.ca

Brazil –
www.omron.com.br