

# Amphenol® MIL-DTL-5015 and MIL-5015 Type Standard Cylindrical Connectors

12-020-18



# Amphenol

| <b>Table of Contents</b>   | <b>Page</b> |
|--|-------------|
| Introduction . . . . .   | 2           |
| Amphenol® MIL-DTL-5015 and MIL-5015 Type Standard Cylindrical Connectors   |             |
| General Information, Class Designations . . . . .  | 3           |
| MS-A, MS-C General Information . . . . .   | 4           |
| MS3100A or C wall mounting receptacle . . . . .  | 5           |
| MS3101A cable connecting plug . . . . .  | 6           |
| MS3102A or C box mounting receptacle . . . . .   | 7           |
| MS3106A straight plug . . . . .  | 8           |
| MS3108A 90 degree plug . . . . .   | 9           |
| MS-E/F General Information . . . . .   | 10          |
| MS3100E/F wall mounting receptacle . . . . .   | 11          |
| MS3101E/F cable connecting plug . . . . .  | 12          |
| MS3102E box mounting receptacle . . . . .  | 13          |
| MS3106E/F straight plug . . . . .  | 14          |
| MS3108E 90 degree plug . . . . .   | 15          |
| MS-R General Information . . . . .   | 16          |
| MS3100R wall mounting receptacle . . . . .   | 17          |
| MS3101R cable connecting plug . . . . .  | 18          |
| MS3102R box mounting receptacle . . . . .  | 19          |
| MS3106R straight plug . . . . .  | 20          |
| Contact and Insert Arrangements . . . . .  | 21          |
| MS/Standard insert arrangement charts . . . . .  | 22, 23      |
| MS/Standard special insert arrangement chart . . . . .   | 24          |
| MS/Standard alternate positioning . . . . .  | 25          |
| MS/Standard contact arrangements . . . . .   | 26 – 37     |
| MS/Standard special contact arrangements . . . . .   | 38 – 48     |
| MS/Standard thermocouple contact arrangements . . . . .  | 49 – 53     |
| MS/Standard Accessories . . . . .  | 54          |
| MS3057A cable clamp, MS3420 sleeve . . . . .   | 55          |
| 10-305200 cable clamp, MS3420( )A sleeve . . . . .   | 56          |
| 10-350349 cable clamp, MS3420( )A sleeve . . . . .   | 57          |
| 10-74900 cable clamp . . . . .   | 58          |
| Thru-bulkhead shells . . . . .   | 59, 60      |
| Assembly instructions for 10-305200 and 10-74900 cable clamps . . . . .  | 61          |
| Grommet/sealing plugs . . . . .  | 62          |
| Plug protection caps . . . . .   | 63          |
| Receptacle protection caps . . . . .   | 64          |
| Dust caps . . . . .  | 65          |
| Sealing gaskets . . . . .  | 66          |
| Solder contacts . . . . .  | 67          |
| Crimp contacts . . . . .   | 68          |
| MS/Standard Application Tools . . . . .  | 69          |
| MS/Standard How to Order . . . . .   | 70          |
| Additional MS/Standard Connectors offered by Amphenol  |             |
| Matrix® MIL-DTL-5015 with crimp rear release contacts, MIL-5015 Type Modification Connectors,<br>97 Series (5015 type) Connectors, Pre-Earth FMLB Connectors . . . . . | 71          |
| Amphe-Power® 5015 Connectors (AC threaded series with high amperage RADSOK® contacts),<br>MIL-5015 Connectors with PCB contacts . . . . .                              | 72          |
| Sales Office Listing   |             |

This catalog covers Amphenol® MIL-DTL-5015 connectors and MIL-5015 type connectors. MIL-C-5015 has been replaced as follows:

Environmental Classes F and R are updated to and produced in strict accordance to MIL-DTL-5015.

Classes A, C and E are still produced, but are no longer listed on the qualified products listing (QPL).

Amphenol gives the user the largest selection of MS/Standard cylindrical connectors available in the market place.

This catalog is divided into three sections; the first section by service class, a second section by contacts and insert arrangements, and a third section for accessories. Each section is prefixed with an overview to assist the user in determining selections.

Should more information be required concerning the connectors covered in this publication, or if special application needs arise, please contact:

Amphenol Corporation  
Amphenol Industrial Operations  
40-60 Delaware Avenue  
Sidney, New York 13838-1395  
Telephone 607-563-5011  
Fax: 607-563-5157  
**[www.amphenol-industrial.com](http://www.amphenol-industrial.com)**

Now, also offered within the broad family of Amphenol interconnection products is the Amphenol®/Matrix® MIL-DTL-5015\* connector series which incorporates rear release crimp contacts. See page 71 for further description and for complete details ask for catalog 12-026.

Also ask for these additional product catalogs:

- Amphenol Industrial Connector Brochure, SL-381, for an overview of the industrial family of connectors.
- Amphenol Catalog SL-100, which provides an overview of all products, military and industrial, offered through Amphenol Aerospace.
- Amphenol Amphe-Power® Brochure SL-391, for AC 5015 type connectors with RADSOK® high amperage contacts. See reference on page 72.

\* Note: MIL-C-5015 is superseded to MIL-DTL-5015 for all Amphenol/Matrix rear release crimp type connectors.

**Amphenol Aerospace operates Quality Systems  
that are Certified to ISO-9001 and AS-9100  
by third party Registrars.**

# Amphenol® MIL-DTL-5015 and MIL-5015 Type Standard Cylindrical Connectors



MS-A, MS-C



MS-E/F



MS-R

## DESIGN CHARACTERISTICS

- Medium to heavy weight cylindrical
- Durable, field-proven design
- Environmental resistant
- Resilient inserts
- Operating voltage to 3000 VAC (RMS) at sea level
- Threaded couplings
- Single key/keyway shell polarization
- Cost effective

## CUSTOMER OPTIONS

- Five shell styles
- Nineteen shell sizes
- 305 contact arrangements from 1 to 104 circuits
- Solder or crimp contacts, sizes 16-0 accepting 22-0 AWG.
- Coaxial and thermocouple contact options
- Five class designations
- Alternate insert positioning
- Hermetic configurations available
- Zinc alloy plating (cadmium-free) available

MS connectors meet the latest performance requirements of MIL-DTL-5015. These connectors represent well-proven electrical capability at an acceptable cost for most equipment where durability is important.

MIL-DTL-5015 features threaded couplings and single key/keyway polarization, representing maximum simplicity in design. Applications include military ground support equipment, ordnance and shipboard installations.

Amphenol Industrial Operations manufactures five classes of connectors to meet different requirements. Class designations and brief descriptions are listed below.

A – Solid Shell – for general, non-environmental applications.

C – Pressurized – for use on pressurized bulkheads or pressure barriers; limits air leakage regardless of type and class of plug mated with them.

E/F – Environmental Resisting with Strain Relief – designed for applications where the connector will be exposed to moisture, vibration, and rapid changes in pressure and temperature.

R – Lightweight Environmental Resisting – shorter in length and lighter in weight than the E and F classes, the MS-R offers a high degree of reliability under adverse conditions: recommended for new design applications.

# MS/Standard MS-A and MS-C



**wall mounting receptacle**



**cable connecting plug**



**box mounting receptacle**



**straight plug**



**90 degree plug**

## MS-A and MS-C

MS-A and MS-C class connectors perform many of the vital functions in powering, testing and ground support systems. Class A applications include communications equipment, computers and shipboard installations where mechanical forces and physical parameters are not subject to extreme or rapid environmental changes.

Class C connectors are most frequently used on pressurized bulkheads or pressure barriers at elevated altitudes or maritime applications. Air leakage is limited to one cubic inch per hour at a pressure differential of 30 lbs. per square inch.

### Shells:

Shell components are fabricated from high grade aluminum alloy. Electrically conductive cadmium plate finish with an olive drab chromate after-treat offers corrosion resistance.

### Contacts:

Contacts are available in both solder and crimp versions. Pins and sockets are machined from copper alloy with a silver plated finish. Size 16 and 12 socket contacts incorporate a closed entry design. Refer to pages 49, 67 and 68 for additional contact information.

### Inserts:

Inserts are resilient neoprene, offering high dielectric strength, high arc resistance and resistance to vibration. Proprietary design permits pressurization of either pin or socket insert.

# MS/Standard MS3100A or C wall mounting receptacle



To complete order number, see "how to order" pg. 70.  
For solder well data, see page 67.

| Shell Size | A Thread Class 2A | B Min Full Thread | K +.020 - .010 | L ±.030 | M +.010 - .000 | R ±.005 | S ±.031 | T Dia. +.004 - .002 | V Thread Class 2A | Z +.050 - .060 |
|------------|-------------------|-------------------|----------------|---------|----------------|---------|---------|---------------------|-------------------|----------------|
| 8S         | .5000-28UNEF      | .391              | .672           | 1.391   | .562           | .594    | .875    | .120                | .5000-28UNEF      | .422           |
| 10S        | .6250-24 UNF      | .391              | .672           | 1.468   | .562           | .719    | 1.000   | .120                | .5000-28UNEF      | .422           |
| 10SL       | .6250-24 UNF      | .391              | .672           | 1.468   | .562           | .719    | 1.000   | .120                | .6250-24NEF       | .422           |
| 12S        | .7500-20UNEF      | .450              | .672           | 1.468   | .562           | .812    | 1.094   | .120                | .6250-24NEF       | .422           |
| 12         | .7500-20UNEF      | .625              | .860           | 1.843   | .750           | .812    | 1.094   | .120                | .6250-24NEF       | .672           |
| 14S        | .8750-20UNEF      | .450              | .672           | 1.468   | .562           | .906    | 1.188   | .120                | .7500-20UNEF      | .422           |
| 14         | .8750-20UNEF      | .625              | .860           | 1.843   | .750           | .906    | 1.188   | .120                | .7500-20UNEF      | .672           |
| 16S        | 1.0000-20UNEF     | .450              | .672           | 1.468   | .562           | .969    | 1.281   | .120                | .8750-20UNEF      | .422           |
| 16         | 1.0000-20UNEF     | .625              | .860           | 1.843   | .750           | .969    | 1.281   | .120                | .8750-20UNEF      | .672           |
| 18         | 1.1250-18NEF      | .625              | .891           | 1.938   | .750           | 1.063   | 1.375   | .120                | 1.0000-20UNEF     | .641*          |
| 20         | 1.2500-18NEF      | .625              | .891           | 1.844   | .750           | 1.156   | 1.500   | .120                | 1.1875-18NEF      | .641*          |
| 22         | 1.3750-18NEF      | .625              | .891           | 1.938   | .750           | 1.250   | 1.625   | .120                | 1.1875-18NEF      | .641*          |
| 24         | 1.5000-18NEF      | .625              | .953           | 1.969   | .812           | 1.375   | 1.750   | .147                | 1.4375-18NEF      | .578*          |
| 28         | 1.7500-18NS       | .625              | .953           | 2.188   | .812           | 1.562   | 2.000   | .147                | 1.4375-18NEF      | .578*          |
| 32         | 2.0000-18NS       | .625              | 1.031          | 2.157   | .875           | 1.750   | 2.250   | .173                | 1.7500-18NS       | .500*          |
| 36         | 2.2500-16UN       | .625              | 1.031          | 2.219   | .875           | 1.938   | 2.500   | .173                | 2.0000-18NS       | .500*          |
| 40         | 2.5000-16UN       | .625              | 1.031          | 2.188   | .875           | 2.188   | 2.750   | .173                | 2.2500-16UN       | .500*          |
| 44***      | 2.7500-16UN       | .625              | 1.031†         | 2.547   | .875           | 2.375   | 3.000†† | .173                | 2.5000-16UN       | .751**         |
| 48***      | 3.0000-16UN       | .625              | 1.031†         | 2.547   | .875           | 2.625   | 3.000†† | .173                | 3.0000-16UN       | .751**         |

\* Increase Z dimension by .312 for size "0" contact only.  
\*\* Increase Z dimension by .062 for size "0" contact only.  
\*\*\* Available in proprietary version only.  
† +.020 -.030  
†† ±.020

# MS/Standard MS3101A cable connecting plug



To complete order number, see "how to order" pg. 70.  
For solder well data, see page 67.

| Shell Size | A Thread Class 2A | B Min. Full Thread | L ±.030 | N Dia. Max. | V Thread Class 2A | Z ±.040 |
|------------|-------------------|--------------------|---------|-------------|-------------------|---------|
| 8S         | .5000-28UNEF      | .406               | 1.390   | .532        | .5000-28UNEF      | 1.094   |
| 10S        | .6250-24NEF       | .406               | 1.468   | .628        | .5000-28UNEF      | 1.094   |
| 10SL       | .6250-24NEF       | .406               | 1.468   | .755        | .6250-24NEF       | 1.094   |
| 12S        | .7500-20UNEF      | .422               | 1.468   | .755        | .6250-24NEF       | 1.094   |
| 12         | .7500-20UNEF      | .656               | 1.843   | .755        | .6250-24NEF       | 1.532   |
| 14S        | .8750-20UNEF      | .391               | 1.468   | .882        | .7500-20UNEF      | 1.094   |
| 14         | .8750-20UNEF      | .625               | 1.843   | .882        | .7500-20UNEF      | 1.532   |
| 16S        | 1.0000-20UNEF     | .391               | 1.468   | 1.010       | .8750-20UNEF      | 1.094   |
| 16         | 1.0000-20UNEF     | .625               | 1.843   | 1.010       | .8750-20UNEF      | 1.532   |
| 18         | 1.1250-18NEF      | .625               | 1.938   | 1.137       | 1.0000-20UNEF     | 1.532*  |
| 20         | 1.2500-18NEF      | .625               | 1.844   | 1.264       | 1.1875-18NEF      | 1.532*  |
| 22         | 1.3750-18NEF      | .625               | 1.938   | 1.392       | 1.1875-18NEF      | 1.532*  |
| 24         | 1.5000-18NEF      | .625               | 1.969   | 1.519       | 1.4375-18NEF      | 1.532*  |
| 28         | 1.7500-18NS       | .625               | 2.188   | 1.774       | 1.4375-18NEF      | 1.532*  |
| 32         | 2.0000-18NS       | .625               | 2.157   | 1.996       | 1.7500-18NS       | 1.532*  |
| 36         | 2.2500-16UN       | .625               | 2.219   | 2.251       | 2.0000-18NS       | 1.532*  |
| 40         | 2.5000-16UN       | .625               | 2.188   | 2.506       | 2.2500-16UN       | 1.532*  |
| 44***      | 2.7500-16UN       | .625               | 2.521   | 3.135       | 2.5000-16UN       | 1.782** |

\* Increase Z dimension by .312 for size "0" contact only.

\*\* Increase Z dimension by .062 for size "0" contact only.

\*\*\* Available in proprietary version only.

# MS/Standard MS3102A or C box mounting receptacle

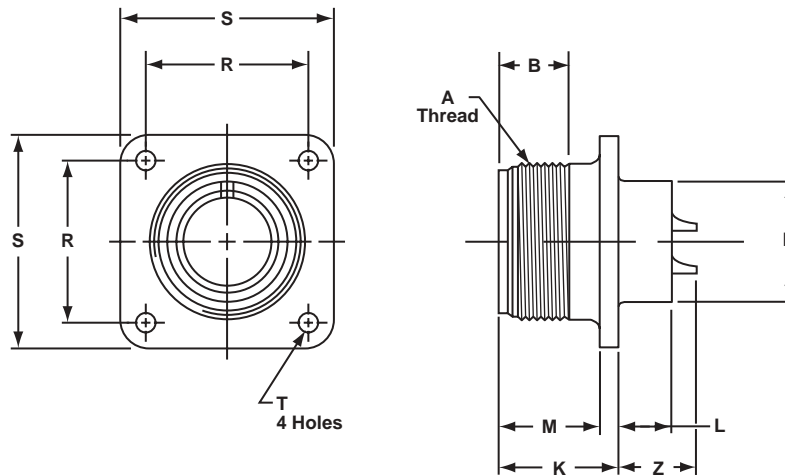

To complete order number, see "how to order" pg. 70.  
For solder well data, see page 67.

| Shell Size | A Thread Class 2A | B Min Full Thread | K +.020 - .010 | L +.000 - .010 | M +.010 - .000 | N Dia. +.010 - .000 | R ±.005 | S ±.031 | T Dia. +.004 - .002 | Z +.050 - .060 |
|------------|-------------------|-------------------|----------------|----------------|----------------|---------------------|---------|---------|---------------------|----------------|
| 8S         | .5000-28UNEF      | .391              | .672           | .297           | .562           | .375                | .594    | .875    | .120                | .422           |
| 10S        | .6250-24NEF       | .391              | .672           | .297           | .562           | .500                | .719    | 1.000   | .120                | .422           |
| 10SL       | .6250-24NEF       | .391              | .672           | .297           | .562           | .625                | .719    | 1.000   | .120                | .422           |
| 12S        | .7500-20UNEF      | .450              | .672           | .297           | .562           | .625                | .812    | 1.094   | .120                | .422           |
| 12         | .7500-20UNEF      | .625              | .860           | .484           | .750           | .625                | .812    | 1.094   | .120                | .672           |
| 14S        | .8750-20UNEF      | .450              | .672           | .297           | .562           | .750                | .906    | 1.188   | .120                | .422           |
| 14         | .8750-20UNEF      | .625              | .860           | .484           | .750           | .750                | .906    | 1.188   | .120                | .672           |
| 16S        | 1.0000-20UNEF     | .450              | .672           | .297           | .562           | .875                | .969    | 1.281   | .120                | .422           |
| 16         | 1.0000-20UNEF     | .625              | .860           | .484           | .750           | .875                | .969    | 1.281   | .120                | .672           |
| 18         | 1.1250-18NEF      | .625              | .891           | .453           | .750           | 1.000               | 1.062   | 1.375   | .120                | .641*          |
| 20         | 1.2500-18NEF      | .625              | .891           | .453           | .750           | 1.125               | 1.156   | 1.500   | .120                | .641*          |
| 22         | 1.3750-18NEF      | .625              | .891           | .453           | .750           | 1.250               | 1.250   | 1.625   | .120                | .641*          |
| 24         | 1.5000-18NEF      | .625              | .953           | .453           | .812           | 1.375               | 1.375   | 1.750   | .147                | .578           |
| 28         | 1.7500-18NS       | .625              | .953           | .453           | .812           | 1.625               | 1.562   | 2.000   | .147                | .578*          |
| 32         | 2.0000-18NS       | .625              | 1.031          | .438           | .875           | 1.875               | 1.750   | 2.250   | .173                | .500*          |
| 36         | 2.2500-16UN       | .625              | 1.031          | .438           | .875           | 2.062               | 1.938   | 2.500   | .173                | .500*          |
| 40         | 2.5000-16UN       | .625              | 1.031          | .438           | .875           | 2.312               | 2.188   | 2.750   | .173                | .500*          |
| 44***      | 2.7500-16UN       | .625              | 1.063          | .543†          | .875           | 2.594               | 2.375   | 3.000†† | .173                | .768**         |
| 48***      | 3.0000-16UN       | .625              | 1.063          | .543†          | .875           | 2.812               | 2.625   | 3.250†† | .209                | .769**         |

\* Increase Z dimension by .312 for size "0" contact only.  
\*\* Increase Z dimension by .062 for size "0" contact only.  
\*\*\* Available in proprietary version only.  
† +.020 -.030  
†† ±.020



# MS/Standard MS3106A straight plug



To complete order number, see "how to order" pg. 70.  
For solder well data, see page 67.  
All lockwire holes are .045 dia. min.

| Shell Size | A Thread Class 2B | J ±.005 | L ±.030 | Q Dia. Max. | V Thread Class 2A | Z ±.045 |
|------------|-------------------|---------|---------|-------------|-------------------|---------|
| 8S         | .5000-28UNEF      | .531    | .859    | .741        | .5000-28UNEF      | .562    |
| 10S        | .6250-24NEF       | .531    | .937    | .869        | .5000-28UNEF      | .562    |
| 10SL       | .6250-24NEF       | .531    | .937    | .946        | .6250-24NEF       | .562    |
| 12S        | .7500-20UNEF      | .531    | .937    | .995        | .6250-24NEF       | .562    |
| 12         | .7500-20UNEF      | .719    | 1.124   | .995        | .6250-24NEF       | .812    |
| 14S        | .8750-20UNEF      | .531    | .937    | 1.123       | .7500-20UNEF      | .562    |
| 14         | .8750-20UNEF      | .719    | 1.124   | 1.123       | .7500-20UNEF      | .812    |
| 16S        | 1.0000-20UNEF     | .531    | .937    | 1.250       | .8750-20UNEF      | .562    |
| 16         | 1.0000-20UNEF     | .719    | 1.124   | 1.250       | .8750-20UNEF      | .812    |
| 18         | 1.1250-18NEF      | .719    | 1.219   | 1.333       | 1.0000-20UNEF     | .812*   |
| 20         | 1.2500-18NEF      | .719    | 1.125   | 1.461       | 1.1875-18NEF      | .812*   |
| 22         | 1.3750-18NEF      | .719    | 1.219   | 1.588       | 1.1875-18NEF      | .812*   |
| 24         | 1.5000-18NEF      | .719    | 1.251   | 1.715       | 1.4375-18NEF      | .812*   |
| 28         | 1.7500-18NS       | .719    | 1.470   | 1.968       | 1.4375-18NEF      | .812*   |
| 32         | 2.0000-18NS       | .719    | 1.439   | 2.209       | 1.7500-18NS       | .812*   |
| 36         | 2.2500-16UN       | .719    | 1.500   | 2.463       | 2.0000-18NS       | .812*   |
| 40         | 2.5000-16UN       | .719    | 1.469   | 2.719       | 2.2500-16UN       | .812*   |
| 44***      | 2.7500-16UN       | .719    | 1.818†  | 3.084       | 2.5000-16UN       | 1.063** |
| 48***      | 3.3000-16UN       | .719    | 1.818†  | 3.354       | 3.0000-16UN       | 1.063** |

\* Increase Z dimension by .312 for size "0" contact only.

\*\* Increase Z dimension by .062 for size "0" contact only.

\*\*\* Available in proprietary version only.

† +.020 -.030

# MS/Standard MS3108A 90 degree plug



To complete order number, see "how to order" pg. 70.  
For solder well data, see page 67.  
All lockwire holes are .045 dia. min.

| Shell Size | A Thread Class 2B | J ±.005 | L Max. | Q Dia. Max. | U Max. | V Thread Class 2A | W    | Z ±.045 |
|------------|-------------------|---------|--------|-------------|--------|-------------------|------|---------|
| 8S         | .5000-28UNEF      | .531    | .896   | .741        | .750   | .5000-28UNEF      | .375 | .562    |
| 10S        | .6250-24NEF       | .531    | .927   | .869        | .750   | .5000-28UNEF      | .375 | .562    |
| 10SL       | .6250-24NEF       | .531    | .951   | .946        | .875   | .6250-24NEF       | .375 | .562    |
| 12S        | .7500-20UNEF      | .531    | .956   | .995        | .875   | .6250-24NEF       | .375 | .562    |
| 12         | .7500-20UNEF      | .719    | 1.143  | .995        | .875   | .6250-24NEF       | .375 | .812    |
| 14S        | .8750-20UNEF      | .531    | 1.120  | 1.123       | 1.000  | .7500-20UNEF      | .375 | .562    |
| 14         | .8750-20UNEF      | .719    | 1.207  | 1.123       | 1.000  | .7500-20UNEF      | .375 | .812    |
| 16S        | 1.0000-20UNEF     | .531    | 1.146  | 1.250       | 1.062  | .8750-20UNEF      | .375 | .562    |
| 16         | 1.0000-20UNEF     | .719    | 1.332  | 1.250       | 1.062  | .8750-20UNEF      | .375 | .812    |
| 18         | 1.1250-18NEF      | .719    | 1.395  | 1.333       | 1.188  | 1.0000-20UNEF     | .375 | .812*   |
| 20         | 1.2500-18NEF      | .719    | 1.645  | 1.461       | 1.250  | 1.1875-18NEF      | .375 | .812*   |
| 22         | 1.3750-18NEF      | .719    | 1.645  | 1.588       | 1.312  | 1.1875-18NEF      | .375 | .812*   |
| 24         | 1.5000-18NEF      | .719    | 1.896  | 1.715       | 1.438  | 1.4375-18NEF      | .375 | .812*   |
| 28         | 1.7500-18NS       | .719    | 1.896  | 1.968       | 1.500  | 1.4375-18NEF      | .375 | .812*   |
| 32         | 2.0000-18NS       | .719    | 2.118  | 2.209       | 1.750  | 1.7500-18NS       | .438 | .812*   |
| 36         | 2.2500-16UN       | .719    | 2.176  | 2.463       | 1.875  | 2.0000-18NS       | .500 | .812*   |
| 40         | 2.5000-16UN       | .719    | 2.301  | 2.719       | 2.031  | 2.2500-16UN       | .500 | .812*   |

\* Increase Z dimension by .312 for size "0" contact only.

# MS/Standard MS-E/F



wall mounting receptacle



cable connecting plug



box mounting receptacle



straight plug



90 degree plug

## MS-E & F

MS Class F connectors satisfy all the performance requirements of MIL-DTL-5015. Class E, environmental is also produced, but is no longer listed on the qualified products listing (QPL). These connectors are recommended for conditions where vibration, moisture, pressure and/or temperature are extreme. Strain relief is supplied on most shell sizes.

### Shells:

Shell components are fabricated from high grade aluminum alloy. The standard hardware plating is electrically conductive cadmium plated finish with an olive drab chromate after-treatment for corrosion resistance. Consult Amphenol, Sidney, NY for other plating options.

### Contacts:

Contacts are silver plated copper alloy for maximum corrosion resistance, maximum current carrying capacity and low millivolt drop. Size 16 and 12 socket contacts incorporate a closed entry design. Crimp and solder versions are available. Refer to pages 49, 67 and 68 for additional contact information.

### Inserts:

Resilient neoprene inserts provide an outstanding moisture barrier, high dielectric strength, and resistance to vibration. Either pin or socket insert can be pressurized.

### Strain Relief Clamp:

Strain relief clamps minimize tension at the solder well connection and provide a positive mechanical moisture seal. Complete field serviceability is possible with the strain relief clamp.

# MS/Standard MS3100E/F wall mounting receptacle



To complete order number, see "how to order" pg. 70.  
For solder well data, see page 67.

| Shell Size | A Thread Class 2A | B Min. Full Thread | K $+0.020$ $-0.010$ | L Max. | M $+0.010$ $-0.000$ | P Max. | R $\pm 0.005$ | S $\pm 0.010$ | T Dia. $+0.004$ $-0.002$ | Z* Max. | XX Min. Cable Clearance |
|------------|-------------------|--------------------|---------------------|--------|---------------------|--------|---------------|---------------|--------------------------|---------|-------------------------|
| 10SL       | .6250-24UNEF      | .391               | .672                | 2.129  | .562                | .896   | .719          | 1.000         | .120                     | .472    | .281                    |
| 12S        | .7500-20UNEF      | .450               | .672                | 2.129  | .562                | .896   | .812          | 1.094         | .120                     | .472    | .281                    |
| 12         | .7500-20UNEF      | .625               | .860                | 2.129  | .750                | .896   | .812          | 1.094         | .120                     | .722    | .281                    |
| 14S        | .8750-20UNEF      | .450               | .672                | 2.201  | .562                | 1.021  | .906          | 1.188         | .120                     | .472    | .406                    |
| 14         | .8750-20UNEF      | .625               | .860                | 2.524  | .750                | 1.021  | .906          | 1.188         | .120                     | .722    | .406                    |
| 16S        | 1.0000-20UNEF     | .450               | .672                | 2.201  | .562                | 1.151  | .969          | 1.281         | .120                     | .472    | .500                    |
| 16         | 1.0000-20UNEF     | .625               | .860                | 2.524  | .750                | 1.151  | .969          | 1.281         | .120                     | .722    | .500                    |
| 18         | 1.1250-18UNEF     | .625               | .891                | 2.596  | .750                | 1.242  | 1.063         | 1.375         | .120                     | .691    | .531                    |
| 20         | 1.2500-18UNEF     | .625               | .891                | 2.654  | .750                | 1.499  | 1.156         | 1.500         | .120                     | .691    | .656                    |
| 22         | 1.3750-18UNEF     | .625               | .891                | 2.654  | .750                | 1.499  | 1.250         | 1.625         | .120                     | .691    | .740                    |
| 24         | 1.5000-18UNEF     | .625               | .953                | 2.885  | .812                | 1.781  | 1.375         | 1.750         | .147                     | .628    | .781                    |
| 28         | 1.7500-18UNS      | .625               | .953                | 2.885  | .812                | 1.781  | 1.562         | 2.000         | .147                     | .628    | .922                    |
| 32         | 2.0000-18UNS      | .625               | 1.031               | 2.943  | .875                | 2.087  | 1.750         | 2.250         | .173                     | .550    | 1.156                   |
| 36         | 2.2500-16UN       | .625               | 1.031               | 2.943  | .875                | 2.281  | 1.938         | 2.500         | .173                     | .550    | 1.250                   |
| 40         | 2.5000-16UN       | .625               | 1.031               | 3.068  | .875                | 2.581  | 2.188         | 2.750         | .173                     | .550    | 1.562                   |

\* Increase Z dimension by .312 for size "0" contact only.

# MS/Standard MS3101E/F cable connecting plug



To complete order number, see "how to order" pg. 70.  
For solder well data, see page 67.

| Shell Size | A Thread Class 2A | B Min. Full Thread | J Max. | L Max. | Z* Max. | XX Min. Cable Clearance |
|------------|-------------------|--------------------|--------|--------|---------|-------------------------|
| 10SL       | .6250-24UNEF      | .406               | .896   | 2.129  | 1.134   | .281                    |
| 12S        | .7500-20UNEF      | .422               | .896   | 2.129  | 1.134   | .281                    |
| 12         | .7500-20UNEF      | .656               | .896   | 2.129  | 1.572   | .281                    |
| 14S        | .8750-20UNEF      | .391               | 1.021  | 2.201  | 1.134   | .406                    |
| 14         | .8750-20UNEF      | .625               | 1.021  | 2.524  | 1.572   | .406                    |
| 16S        | 1.0000-20UNEF     | .391               | 1.151  | 2.201  | 1.134   | .500                    |
| 16         | 1.0000-20UNEF     | .625               | 1.151  | 2.524  | 1.572   | .500                    |
| 18         | 1.1250-18UNEF     | .625               | 1.242  | 2.596  | 1.572   | .531                    |
| 20         | 1.2500-18UNEF     | .625               | 1.499  | 2.654  | 1.572   | .656                    |
| 22         | 1.3750-18UNEF     | .625               | 1.499  | 2.654  | 1.572   | .740                    |
| 24         | 1.5000-18UNEF     | .625               | 1.781  | 2.885  | 1.572   | .781                    |
| 28         | 1.7500-18UNS      | .625               | 1.781  | 2.885  | 1.572   | .922                    |
| 32         | 2.0000-18UNS      | .625               | 2.087  | 2.943  | 1.572   | 1.156                   |
| 36         | 2.2500-16UN       | .625               | 2.281  | 2.943  | 1.572   | 1.250                   |
| 40         | 2.5000-16UN       | .625               | 2.581  | 3.068  | 1.572   | 1.562                   |

\* Increase Z dimension by .312 for size "0" contact only.

# MS/Standard MS3102E box mounting receptacle



To complete order number, see "how to order" pg. 70.  
For solder well data, see page 67.

| Shell Size | A Thread Class 2A | B Min. Full Thread | K +.020 - .010 | L +.000 - .010 | M +.010 - .000 | N Dia. +.010 - .000 | R ±.005 | S ±.031 | T Dia. +.004 - .002 | Z +.050 - .060 |
|------------|-------------------|--------------------|----------------|----------------|----------------|---------------------|---------|---------|---------------------|----------------|
| 8S         | .5000-28UNEF      | .391               | .672           | .297           | .562           | .375                | .594    | .875    | .120                | .422           |
| 10S        | .6250-24NEF       | .391               | .672           | .297           | .562           | .500                | .719    | 1.000   | .120                | .422           |
| 10SL       | .6250-24NEF       | .391               | .672           | .297           | .562           | .625                | .719    | 1.000   | .120                | .422           |
| 12S        | .7500-20UNEF      | .450               | .672           | .297           | .562           | .625                | .812    | 1.094   | .120                | .422           |
| 12         | .7500-20UNEF      | .625               | .860           | .484           | .750           | .625                | .812    | 1.094   | .120                | .672           |
| 14S        | .8750-20UNEF      | .450               | .672           | .297           | .562           | .750                | .906    | 1.188   | .120                | .422           |
| 14         | .8750-20UNEF      | .625               | .860           | .484           | .750           | .750                | .906    | 1.188   | .120                | .672           |
| 16S        | 1.0000-20UNEF     | .450               | .672           | .297           | .562           | .875                | .969    | 1.281   | .120                | .422           |
| 16         | 1.0000-20UNEF     | .625               | .860           | .484           | .750           | .875                | .969    | 1.281   | .120                | .672           |
| 18         | 1.1250-18NEF      | .625               | .891           | .453           | .750           | 1.000               | 1.062   | 1.375   | .120                | .641*          |
| 20         | 1.2500-18NEF      | .625               | .891           | .453           | .750           | 1.125               | 1.156   | 1.500   | .120                | .641*          |
| 22         | 1.3750-18NEF      | .625               | .891           | .453           | .750           | 1.250               | 1.250   | 1.625   | .120                | .641*          |
| 24         | 1.5000-18NEF      | .625               | .953           | .453           | .812           | 1.375               | 1.375   | 1.750   | .147                | .578*          |
| 28         | 1.7500-18NS       | .625               | .953           | .453           | .812           | 1.625               | 1.562   | 2.000   | .147                | .578*          |
| 32         | 2.0000-18NS       | .625               | 1.031          | .438           | .875           | 1.875               | 1.750   | 2.250   | .173                | .500*          |
| 36         | 2.2500-16UN       | .625               | 1.031          | .438           | .875           | 2.062               | 1.938   | 2.500   | .173                | .500*          |
| 40         | 2.5000-16UN       | .625               | 1.031          | .438           | .875           | 2.312               | 2.188   | 2.750   | .173                | .500*          |

\* Increase Z dimension by .312 for size "0" contact only.

# MS/Standard MS3106E/F straight plug



To complete order number, see "how to order" pg. 70.  
For solder well data, see page 67.  
All lockwire holes are .045 dia. min.

| Shell Size | A Thread Class 2A | B ±.005 | J Max. | L Max. | Q Max. | Z* ±.045 | XX Min. Cable Clearance |
|------------|-------------------|---------|--------|--------|--------|----------|-------------------------|
| 10SL       | .6250-24UNEF      | .531    | .896   | 2.129  | .946   | .607     | .281                    |
| 12S        | .7500-20UNEF      | .531    | .896   | 2.129  | .995   | .607     | .281                    |
| 12         | .7500-20UNEF      | .719    | .896   | 2.129  | .995   | .857     | .281                    |
| 14S        | .8750-20UNEF      | .531    | 1.021  | 2.201  | 1.123  | .607     | .406                    |
| 14         | .8750-20UNEF      | .719    | 1.021  | 2.524  | 1.123  | .857     | .406                    |
| 16S        | 1.0000-20UNEF     | .531    | 1.151  | 2.201  | 1.250  | .607     | .500                    |
| 16         | 1.0000-20UNEF     | .719    | 1.151  | 2.524  | 1.250  | .857     | .500                    |
| 18         | 1.1250-18UNEF     | .719    | 1.242  | 2.596  | 1.333  | .857     | .531                    |
| 20         | 1.2500-18UNEF     | .719    | 1.499  | 2.654  | 1.461  | .857     | .656                    |
| 22         | 1.3750-18UNEF     | .719    | 1.499  | 2.654  | 1.588  | .857     | .740                    |
| 24         | 1.5000-18UNEF     | .719    | 1.781  | 2.885  | 1.715  | .857     | .781                    |
| 28         | 1.7500-18UNS      | .719    | 1.781  | 2.885  | 1.968  | .857     | .922                    |
| 32         | 2.0000-18UNS      | .719    | 2.087  | 2.943  | 2.209  | .857     | 1.156                   |
| 36         | 2.2500-16UN       | .719    | 2.281  | 2.943  | 2.463  | .857     | 1.250                   |
| 40         | 2.5000-16UN       | .719    | 2.581  | 3.068  | 2.718  | .857     | 1.562                   |

\* Increase Z dimension by .312 for size "0" contact only.

# MS/Standard MS3108E 90 degree plug



To complete order number, see "how to order" pg. 70.  
For solder well data, see page 67.  
All lockwire holes are .045 dia. min.

| Shell Size | A Thread Class 2B | J ±.005 | L Max. | N Max. | Q Dia. Max. | U Max. | Y Thread Class 2B | Z ±.045 |
|------------|-------------------|---------|--------|--------|-------------|--------|-------------------|---------|
| 8S         | .5000-28UNEF      | .531    | .927   | .807   | .741        | 1.445  | 6-32NC            | .562    |
| 10S        | .6250-24NEF       | .531    | .927   | .807   | .869        | 1.445  | 6-32NC            | .562    |
| 10SL       | .6250-24NEF       | .531    | .951   | .901   | .946        | 1.508  | 6-32NC            | .562    |
| 12S        | .7500-20UNEF      | .531    | .956   | .901   | .995        | 1.508  | 6-32NC            | .562    |
| 12         | .7500-20UNEF      | .719    | 1.143  | .901   | .995        | 1.508  | 6-32NC            | .812    |
| 14S        | .8750-20UNEF      | .531    | 1.020  | 1.026  | 1.123       | 1.570  | 6-32NC            | .562    |
| 14         | .8750-20UNEF      | .719    | 1.207  | 1.026  | 1.123       | 1.570  | 6-32NC            | .812    |
| 16S        | 1.0000-20UNEF     | .531    | 1.146  | 1.119  | 1.250       | 1.633  | 6-32NC            | .562    |
| 16         | 1.1000-20UNEF     | .719    | 1.333  | 1.119  | 1.250       | 1.633  | 6-32NC            | .812    |
| 18         | 1.1250-18NEF      | .719    | 1.395  | 1.229  | 1.333       | 1.759  | 6-32NC            | .812*   |
| 20         | 1.2500-18NEF      | .719    | 1.598  | 1.479  | 1.461       | 1.931  | 8-32NC            | .812*   |
| 22         | 1.3750-18NEF      | .719    | 1.598  | 1.479  | 1.588       | 1.993  | 8-32NC            | .812*   |
| 24         | 1.5000-18NEF      | .719    | 1.786  | 1.666  | 1.729       | 2.119  | 8-32NC            | .812*   |
| 28         | 1.7500-18NS       | .719    | 1.786  | 1.666  | 1.968       | 2.181  | 8-32NC            | .812*   |
| 32         | 2.0000-18NS       | .719    | 2.020  | 2.135  | 2.209       | 2.570  | 10-32NF           | .812*   |
| 36         | 2.2500-16UN       | .719    | 2.145  | 2.260  | 2.463       | 2.695  | 10-32NF           | .812*   |
| 40         | 2.5000-16UN       | .719    | 2.270  | 2.510  | 2.719       | 2.851  | 10-32NF           | .812*   |

\* Increase Z dimension by .312 for size "0" contact only.



# MS/Standard MS-R



**wall mounting receptacle**



**cable connecting plug**



**box mounting receptacle**



**straight plug**

## MS-R

Specification requirements for greater reliability in a shorter, lighter weight environmental resistant connector led to the design of the MS-R. MS Class R connectors satisfy all the performance requirements of MIL-DTL-5015.

This low profile assembly was attained by moving the axial compression nut and grommet assembly forward and flush with the rear of the insert. The neoprene grommet, with its low coefficient of friction, assures easier threading of wire bundles and quicker assembly and serviceability of the unit. Molded webs in each wire hole insure a moisture barrier around each wire.

The addition of an "O" ring at the main joint of all MS3106R plugs provide a main joint seal supplementary to the interfacial seal, thus insuring a higher degree of reliability when connector halves from different sources are employed. MS-R types are recommended for new design applications.

### Shells:

Shell components are fabricated from high grade aluminum alloy. All components have the standard electrically conductive cadmium plated finish with an olive drab chromate after-treatment for corrosion resistance. Consult Amphenol, Sidney, NY for other plating options.

### Contacts:

Contacts are machined from copper alloy for maximum corrosion resistance, maximum current carrying capacity and low millivolt drop. Both crimp and solder versions are available. Refer to pages 49, 67 and 68 for additional contact information.

### Inserts:

Resilient neoprene inserts provide an outstanding moisture barrier, maximum vibration resistance and high dielectric strength. Either pin or socket insert can be pressurized.

# MS/Standard MS3100R wall mounting receptacle

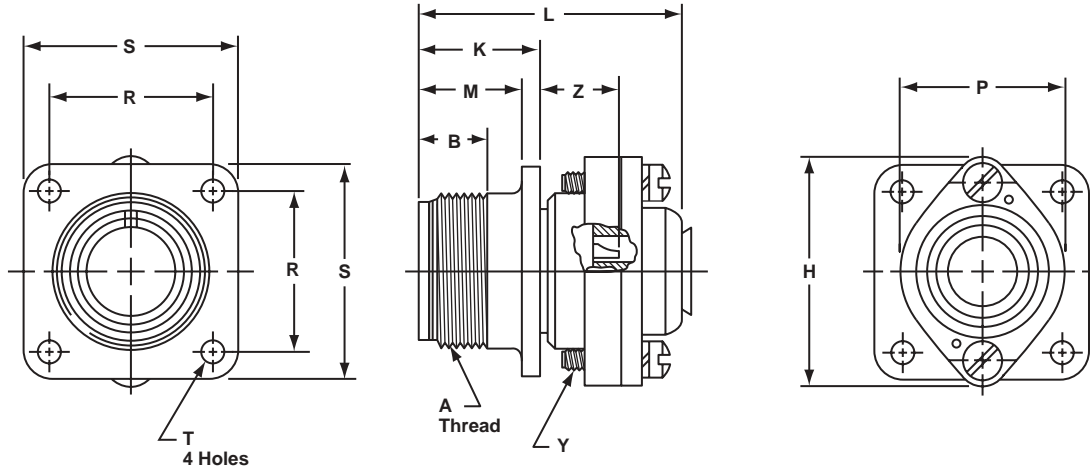

To complete order number, see "how to order" pg. 70.  
For solder well data, see page 67.  
All lockwire holes are .045 dia. min.

| Shell Size | A Thread Class 2A | B Min. Full Thread | H Dia. Max. | K +.020 - .010 | L Max. | M +.010 - .000 | P Dia. Max. | R ±.005 | S ±.031 | Y Thread Class 2 | T Dia. +.004 - .002 | Z +.050 - .060 |
|------------|-------------------|--------------------|-------------|----------------|--------|----------------|-------------|---------|---------|------------------|---------------------|----------------|
| 8S         | .5000-28UNEF      | .391               | .959        | .672           | 1.588  | .562           | .557        | .594    | .875    | 6-32NC           | .120                | .422           |
| 10S        | .6250-24NEF       | .391               | 1.026       | .672           | 1.588  | .562           | .682        | .719    | 1.000   | 6-32NC           | .120                | .422           |
| 10SL       | .6250-24NEF       | .391               | 1.120       | .672           | 1.588  | .562           | .807        | .719    | 1.000   | 6-32NC           | .120                | .422           |
| 12S        | .7500-20UNEF      | .450               | 1.120       | .672           | 1.588  | .562           | .807        | .812    | 1.094   | 6-32NC           | .120                | .422           |
| 12         | .7500-20UNEF      | .625               | 1.120       | .860           | 1.931  | .750           | .807        | .812    | 1.094   | 6-32NC           | .120                | .672           |
| 14S        | .8750-20UNEF      | .450               | 1.307       | .672           | 1.588  | .562           | .932        | .906    | 1.188   | 6-32NC           | .120                | .422           |
| 14         | .8750-20UNEF      | .625               | 1.307       | .860           | 1.931  | .750           | .932        | .906    | 1.188   | 6-32NC           | .120                | .672           |
| 16S        | 1.0000-20UNEF     | .450               | 1.432       | .672           | 1.588  | .562           | 1.057       | .969    | 1.281   | 6-32NC           | .120                | .422           |
| 16         | 1.0000-20UNEF     | .625               | 1.432       | .860           | 1.931  | .750           | 1.057       | .969    | 1.281   | 6-32NC           | .120                | .672           |
| 18         | 1.1250-18NEF      | .625               | 1.557       | .891           | 1.931  | .750           | 1.182       | 1.063   | 1.375   | 6-32NC           | .120                | .641*          |
| 20         | 1.2500-18NEF      | .625               | 1.744       | .891           | 1.931  | .750           | 1.291       | 1.156   | 1.500   | 8-32NC           | .120                | .641*          |
| 22         | 1.3750-18NEF      | .625               | 1.869       | .891           | 1.931  | .750           | 1.432       | 1.250   | 1.625   | 8-32NC           | .120                | .641*          |
| 24         | 1.5000-18NEF      | .625               | 1.994       | .953           | 2.009  | .812           | 1.557       | 1.375   | 1.750   | 8-32NC           | .147                | .578*          |
| 28         | 1.7500-18NS       | .625               | 2.166       | .953           | 2.009  | .812           | 1.807       | 1.562   | 2.000   | 8-32NC           | .147                | .578*          |
| 32         | 2.0000-18NS       | .625               | 2.541       | 1.031          | 2.072  | .875           | 2.057       | 1.750   | 2.250   | 10-32NF          | .173                | .500*          |
| 36         | 2.2500-16UN       | .625               | 2.729       | 1.031          | 2.072  | .875           | 2.260       | 1.938   | 2.500   | 10-32NF          | .173                | .500*          |
| 40         | 2.5000-16UN       | .625               | 2.979       | 1.031          | 2.072  | .875           | 2.260       | 2.510   | 2.750   | 10-32NF          | .173                | .500*          |

\* Increase Z dimension by .312 for size "0" contact only.

# MS/Standard MS3101R cable connecting plug



To complete order number, see "how to order" pg. 70.  
For solder well data, see page 67.  
All lockwire holes are .045 dia. min.

| Shell Size | A Thread Class 2A | B Min. Full Thread | F Dia. Max. | J Dia. Max. | L Max. | Y Thread Class 2 | Z ±.040 |
|------------|-------------------|--------------------|-------------|-------------|--------|------------------|---------|
| 8S         | .5000-28UNEF      | .406               | .959        | .557        | 1.588  | 6-32NC           | 1.094   |
| 10S        | .6250-24NEF       | .406               | 1.026       | .682        | 1.588  | 6-32NC           | 1.094   |
| 10SL       | .6250-24NEF       | .406               | 1.120       | .807        | 1.588  | 6-32NC           | 1.094   |
| 12S        | .7500-20UNEF      | .422               | 1.120       | .807        | 1.588  | 6-32NC           | 1.094   |
| 12         | .7500-20UNEF      | .656               | 1.120       | .807        | 1.931  | 6-32NC           | 1.532   |
| 14S        | .8750-20UNEF      | .391               | 1.307       | .932        | 1.588  | 6-32NC           | 1.094   |
| 14         | .8750-20UNEF      | .625               | 1.307       | .932        | 1.931  | 6-32NC           | 1.532   |
| 16S        | 1.0000-20UNEF     | .391               | 1.432       | 1.057       | 1.588  | 6-32NC           | 1.094   |
| 16         | 1.0000-20UNEF     | .625               | 1.432       | 1.057       | 1.931  | 6-32NC           | 1.532   |
| 18         | 1.1250-18NEF      | .625               | 1.557       | 1.182       | 1.931  | 6-32NC           | 1.532*  |
| 20         | 1.2500-18NEF      | .625               | 1.744       | 1.291       | 1.931  | 8-32NC           | 1.532*  |
| 22         | 1.3750-18NEF      | .625               | 1.869       | 1.432       | 1.931  | 8-32NC           | 1.532*  |
| 24         | 1.5000-18NEF      | .625               | 1.994       | 1.557       | 2.009  | 8-32NC           | 1.532*  |
| 28         | 1.7500-18NS       | .625               | 2.166       | 1.807       | 2.009  | 8-32NC           | 1.532*  |
| 32         | 2.0000-18NS       | .625               | 2.541       | 2.057       | 2.072  | 10-32NF          | 1.532*  |
| 36         | 2.2500-16UN       | .625               | 2.729       | 2.260       | 2.072  | 10-32NF          | 1.532*  |
| 40         | 2.5000-16UN       | .625               | 2.979       | 2.510       | 2.072  | 10-32NF          | 1.532*  |

\* Increase Z dimension by .312 for size "0" contact only.

# MS/Standard MS3102R box mounting receptacle



To complete order number, see "how to order" pg. 70.  
For solder well data, see page 67.

| Shell Size | A Thread Class 2A | B Min. Full Thread | K +.020 - .010 | L +.000 - .010 | M +.010 - .000 | N Dia. +.010 - .000 | R ±.005 | S ±.031 | T Dia. +.004 - .002 | Z +.050 - .060 |
|------------|-------------------|--------------------|----------------|----------------|----------------|---------------------|---------|---------|---------------------|----------------|
| 8S         | .5000-28UNEF      | .391               | .672           | .297           | .562           | .375                | .594    | .875    | .120                | .422           |
| 10S        | .6250-24NEF       | .391               | .672           | .297           | .562           | .500                | .719    | 1.000   | .120                | .422           |
| 10SL       | .6250-24NEF       | .391               | .672           | .297           | .562           | .625                | .719    | 1.000   | .120                | .422           |
| 12S        | .7500-20UNEF      | .450               | .672           | .297           | .562           | .625                | .812    | 1.094   | .120                | .422           |
| 12         | .7500-20UNEF      | .625               | .860           | .484           | .750           | .625                | .812    | 1.094   | .120                | .672           |
| 14S        | .8750-20UNEF      | .450               | .672           | .297           | .562           | .750                | .906    | 1.188   | .120                | .422           |
| 14         | .8750-20UNEF      | .625               | .860           | .484           | .750           | .750                | .906    | 1.188   | .120                | .672           |
| 16S        | 1.0000-20UNEF     | .450               | .672           | .297           | .562           | .875                | .969    | 1.281   | .120                | .422           |
| 16         | 1.0000-20UNEF     | .625               | .860           | .484           | .750           | .875                | .969    | 1.281   | .120                | .672           |
| 18         | 1.1250-18NEF      | .625               | .891           | .453           | .750           | 1.000               | 1.062   | 1.375   | .120                | .641*          |
| 20         | 1.2500-18NEF      | .625               | .891           | .453           | .750           | 1.125               | 1.156   | 1.500   | .120                | .641*          |
| 22         | 1.3750-18NEF      | .625               | .891           | .453           | .750           | 1.250               | 1.250   | 1.625   | .120                | .641*          |
| 24         | 1.5000-18NEF      | .625               | .953           | .453           | .812           | 1.375               | 1.375   | 1.750   | .147                | .578*          |
| 28         | 1.7500-18NS       | .625               | .953           | .453           | .812           | 1.625               | 1.562   | 2.000   | .147                | .578*          |
| 32         | 2.0000-18NS       | .625               | 1.031          | .438           | .875           | 1.875               | 1.750   | 2.250   | .173                | .500*          |
| 36         | 2.2500-16UN       | .625               | 1.031          | .438           | .875           | 2.062               | 1.938   | 2.500   | .173                | .500*          |
| 40         | 2.5000-16UN       | .625               | 1.031          | .438           | .875           | 2.312               | 2.188   | 2.750   | .173                | .500*          |

\* Increase Z dimension by .312 for size "0" contact only.

# MS/Standard MS3106R straight plug



To complete order number, see "how to order" pg. 70.  
For solder well data, see page 67.  
All lockwire holes are .045 dia. min.

| Shell Size | A Thread Class 2B | F Dia. Max. | J $\pm .005$ | L Max. | N Dia. Max. | Q Dia. Max. | Y Thread Class 2 | Z $\pm .045$ |
|------------|-------------------|-------------|--------------|--------|-------------|-------------|------------------|--------------|
| 8S         | .5000-28UNEF      | .959        | .531         | 1.057  | .557        | .741        | 6-32NC           | .562         |
| 10S        | .6250-24NEF       | 1.026       | .531         | 1.057  | .682        | .869        | 6-32NC           | .562         |
| 10SL       | .6250-24NEF       | 1.120       | .531         | 1.057  | .807        | .946        | 6-32NC           | .562         |
| 12S        | .7500-20UNEF      | 1.120       | .531         | 1.057  | .807        | .995        | 6-32NC           | .562         |
| 12         | .7500-20UNEF      | 1.120       | .719         | 1.212  | .807        | .995        | 6-32NC           | .812         |
| 14S        | .8750-20UNEF      | 1.307       | .531         | 1.057  | .932        | 1.123       | 6-32NC           | .562         |
| 14         | .8750-20UNEF      | 1.307       | .719         | 1.212  | .932        | 1.123       | 6-32NC           | .812         |
| 16S        | 1.0000-20UNEF     | 1.432       | .531         | 1.057  | 1.057       | 1.250       | 6-32NC           | .562         |
| 16         | 1.0000-20UNEF     | 1.432       | .719         | 1.212  | 1.057       | 1.250       | 6-32NC           | .812         |
| 18         | 1.1250-18NEF      | 1.557       | .719         | 1.212  | 1.182       | 1.333       | 6-32NC           | .812*        |
| 20         | 1.2500-18NEF      | 1.744       | .719         | 1.212  | 1.291       | 1.461       | 8-32NC           | .812*        |
| 22         | 1.3750-18NEF      | 1.869       | .719         | 1.212  | 1.432       | 1.588       | 8-32NC           | .812*        |
| 24         | 1.5000-18NEF      | 1.994       | .719         | 1.291  | 1.557       | 1.715       | 8-32NC           | .812*        |
| 28         | 1.7500-18NS       | 2.166       | .719         | 1.291  | 1.807       | 1.968       | 8-32NC           | .812*        |
| 32         | 2.0000-18NS       | 2.541       | .719         | 1.353  | 2.057       | 2.209       | 10-32NF          | .812*        |
| 36         | 2.2500-16UN       | 2.729       | .719         | 1.353  | 2.260       | 2.463       | 10-32NF          | .812*        |
| 40         | 2.5000-16UN       | 2.979       | .719         | 1.353  | 2.510       | 2.719       | 10-32NF          | .812*        |

\* Increase Z dimension by .312 for size "0" contact only.

**MS/Standard**  
contact and  
insert arrangements

# MS/Standard insert arrangements

| Insert Arrangement | Service Rating | Total Contacts | Contact Size |   |   |    |    |
|--------------------|----------------|----------------|--------------|---|---|----|----|
|                    |                |                | 0            | 4 | 8 | 12 | 16 |
| 8S-1               | A              | 1              |              |   |   |    | 1  |
| 10S-2              | A              | 1              |              |   |   |    | 1  |
| 10SL-3             | A              | 3              |              |   |   |    | 3  |
| 10SL-4†            | A              | 2              |              |   |   |    | 2  |
| 12S-3              | A              | 2              |              |   |   |    | 2  |
| 12S-4              | D              | 1              |              |   |   |    | 1  |
| 12-5               | D              | 1              |              |   |   | 1  |    |
| 14S-1              | A              | 3              |              |   |   |    | 3  |
| 14S-2              | Inst.          | 4              |              |   |   |    | 4  |
| 14S-4              | D              | 1              |              |   |   |    | 1  |
| 14S-5              | Inst.          | 5              |              |   |   |    | 5  |
| 14S-6              | Inst.          | 6              |              |   |   |    | 6  |
| 14S-7              | A              | 3              |              |   |   |    | 3  |
| 14S-9              | A              | 2              |              |   |   |    | 2  |
| 14S-10             | Inst.          | 4              |              |   |   |    | 4  |
| 14S-12             | A              | 3              |              |   |   |    | 3  |
| 14-3               | A              | 1              |              |   | 1 |    |    |
| 16S-1              | A              | 7              |              |   |   |    | 7  |
| 16S-3              | B              | 1              |              |   |   |    | 1  |
| 16S-4              | D              | 2              |              |   |   |    | 2  |
| 16S-5              | A              | 3              |              |   |   |    | 3  |
| 16S-6              | A              | 3              |              |   |   |    | 3  |
| 16S-8              | A              | 5              |              |   |   |    | 5  |
| 16-2               | E              | 1              |              |   |   | 1  |    |
| 16-7               | A              | 3              |              |   | 1 |    | 2  |
| 16-9               | A              | 4              |              |   |   | 2  | 2  |
| 16-10              | A              | 3              |              |   |   | 3  |    |
| 16-11              | A              | 2              |              |   |   | 2  |    |
| 16-12              | A              | 1              |              | 1 |   |    |    |
| 16-13              | A              | 2              |              |   |   | 2  |    |
| 18-1               | A/Inst.        | 10             |              |   |   |    | 10 |
| 18-3               | D              | 2              |              |   |   | 2  |    |
| 18-4               | D              | 4              |              |   |   |    | 4  |
| 18-5               | D              | 3              |              |   |   | 2  | 1  |
| 18-6               | D              | 1              |              | 1 |   |    |    |
| 18-7               | B              | 1              |              |   | 1 |    |    |
| 18-8               | A              | 8              |              |   |   | 1  | 7  |
| 18-9               | Inst.          | 7              |              |   |   | 2  | 5  |
| 18-10              | A              | 4              |              |   |   | 4  |    |
| 18-11              | A              | 5              |              |   |   | 5  |    |
| 18-12              | A              | 6              |              |   |   |    | 6  |
| 18-13              | A              | 4              |              |   | 1 | 3  |    |
| 18-14              | A              | 2              |              | 1 |   |    | 1  |
| 18-15              | A              | 4              |              |   |   | 4  |    |
| 18-16              | C              | 1              |              |   |   | 1  |    |
| 18-17              | Inst.          | 7              |              |   |   | 2  | 5  |
| 18-19              | A              | 10             |              |   |   |    | 10 |
| 18-20              | A              | 5              |              |   |   |    | 5  |
| 18-22              | D              | 3              |              |   |   |    | 3  |
| 18-24              | A/Inst.        | 10             |              |   |   |    | 10 |
| 18-29              | A              | 5              |              |   |   |    | 5  |
| 18-30              | A              | 5              |              |   |   |    | 5  |

| Insert Arrangement | Service Rating | Total Contacts | Contact Size |   |   |    |    |
|--------------------|----------------|----------------|--------------|---|---|----|----|
|                    |                |                | 0            | 4 | 8 | 12 | 16 |
| 18-31              | A              | 5              |              |   |   |    | 5  |
| 20-2               | D              | 1              | 1            |   |   |    |    |
| 20-3               | D              | 3              |              |   |   | 3  |    |
| 20-4               | D              | 4              |              |   |   | 4  |    |
| 20-6               | D              | 3              |              |   |   |    | 3  |
| 20-7               | D/A            | 8              |              |   |   |    | 8  |
| 20-8               | Inst.          | 6              |              |   | 2 |    | 4  |
| 20-9               | D/A            | 8              |              |   |   | 1  | 7  |
| 20-11              | Inst.          | 13             |              |   |   |    | 13 |
| 20-12              | A              | 2              |              | 1 |   |    | 1  |
| 20-14              | A              | 5              |              |   | 2 | 3  |    |
| 20-15              | A              | 7              |              |   |   | 7  |    |
| 20-16              | A              | 9              |              |   |   | 2  | 7  |
| 20-17              | A              | 6              |              |   |   | 5  | 1  |
| 20-18              | A              | 9              |              |   |   | 3  | 6  |
| 20-19              | A              | 3              |              |   | 3 |    |    |
| 20-20              | A              | 4              |              | 1 |   | 3  |    |
| 20-21              | A              | 9              |              |   |   | 1  | 8  |
| 20-22              | A              | 6              |              |   | 3 |    | 3  |
| 20-23              | A              | 2              |              |   | 2 |    |    |
| 20-24              | A              | 4              |              |   | 2 |    | 2  |
| 20-25              | Inst.          | 13             |              |   |   |    | 13 |
| 20-27              | A              | 14             |              |   |   |    | 14 |
| 20-29              | A              | 17             |              |   |   |    | 17 |
| 20-30              | Inst.          | 13             |              |   |   |    | 13 |
| 20-33              | A              | 11             |              |   |   |    | 11 |
| 22-1               | D              | 2              |              |   | 2 |    |    |
| 22-2               | D              | 3              |              |   | 3 |    |    |
| 22-4               | A              | 4              |              |   | 2 | 2  |    |
| 22-5               | D              | 6              |              |   |   | 2  | 4  |
| 22-6               | D              | 3              |              |   | 2 |    | 1  |
| 22-7               | E              | 1              | 1            |   |   |    |    |
| 22-8               | E              | 2              |              |   |   | 2  |    |
| 22-9               | E              | 3              |              |   |   | 3  |    |
| 22-10              | E              | 4              |              |   |   |    | 4  |
| 22-11              | B              | 2              |              |   |   |    | 2  |
| 22-12              | D              | 5              |              |   | 2 |    | 3  |
| 22-13              | D/A            | 5              |              |   |   | 4  | 1  |
| 22-14              | A              | 19             |              |   |   |    | 19 |
| 22-15              | E/A            | 6              |              |   |   | 5  | 1  |
| 22-16              | A              | 9              |              |   |   | 3  | 6  |
| 22-17              | D/A            | 9              |              |   |   | 1  | 8  |
| 22-18              | D/A            | 8              |              |   |   |    | 8  |
| 22-19              | A              | 14             |              |   |   |    | 14 |
| 22-20              | A              | 9              |              |   |   |    | 9  |
| 22-21              | A              | 3              | 1            |   |   |    | 2  |
| 22-22              | A              | 4              |              |   | 4 |    |    |
| 22-23              | D/A            | 8              |              |   |   | 8  |    |
| 22-24              | D/A            | 6              |              |   |   | 2  | 4  |
| 22-27              | D/A            | 9              |              |   | 1 |    | 8  |
| 22-28              | A              | 7              |              |   |   | 7  |    |

† 10SL-4 arrangement available only with pin contacts in receptacle and socket contacts in plug

# MS/Standard insert arrangements, cont.

| Insert Arrangement | Service Rating | Total Contacts | Contact Size |   |   |    |    |
|--------------------|----------------|----------------|--------------|---|---|----|----|
|                    |                |                | 0            | 4 | 8 | 12 | 16 |
| 22-33              | D/A            | 7              |              |   |   |    | 7  |
| 22-34              | D              | 5              |              |   |   | 3  | 2  |
| 22-36              | D/A            | 8              |              |   |   | 8  |    |
| 24-2               | D              | 7              |              |   |   | 7  |    |
| 24-3               | D              | 7              |              |   |   | 2  | 5  |
| 24-5               | A              | 16             |              |   |   |    | 16 |
| 24-6               | D/A            | 8              |              |   |   | 8  |    |
| 24-7               | A              | 16             |              |   |   | 2  | 14 |
| 24-9               | A              | 2              |              | 2 |   |    |    |
| 24-10              | A              | 7              |              |   | 7 |    |    |
| 24-11              | A              | 9              |              |   | 3 | 6  |    |
| 24-12              | A              | 5              |              | 2 |   | 3  |    |
| 24-16              | D/A            | 7              |              |   | 1 | 3  | 3  |
| 24-17              | D              | 5              |              |   |   | 2  | 3  |
| 24-20              | D              | 11             |              |   |   | 2  | 9  |
| 24-21              | D              | 10             |              |   | 1 |    | 9  |
| 24-22              | D              | 4              |              |   | 4 |    |    |
| 24-27              | E              | 7              |              |   |   |    | 7  |
| 24-28              | Inst.          | 24             |              |   |   |    | 24 |
| 28-1               | D/A            | 9              |              |   | 3 | 6  |    |
| 28-2               | D              | 14             |              |   |   | 2  | 12 |
| 28-3               | E              | 3              |              |   | 3 |    |    |
| 28-4               | E/D            | 9              |              |   |   | 2  | 7  |
| 28-5               | D              | 5              |              | 2 |   | 1  | 2  |
| 28-6               | D              | 3              |              | 3 |   |    |    |
| 28-7               | D              | 2              |              | 2 |   |    |    |
| 28-8               | E/D/A          | 12             |              |   |   | 2  | 10 |
| 28-9               | D              | 12             |              |   |   | 6  | 6  |
| 28-10              | D/A            | 7              |              | 2 | 2 | 3  |    |
| 28-11              | A              | 22             |              |   |   | 4  | 18 |
| 28-12              | A              | 26             |              |   |   |    | 26 |
| 28-13              | A              | 26             |              |   |   |    | 26 |
| 28-15              | A              | 35             |              |   |   |    | 35 |
| 28-16              | A              | 20             |              |   |   |    | 20 |
| 28-17              | B/D/A          | 15             |              |   |   |    | 15 |
| 28-18              | C/D/A/Inst.    | 12             |              |   |   |    | 12 |
| 28-19              | B/D/A          | 10             |              |   |   | 4  | 6  |
| 28-20              | A              | 14             |              |   |   | 10 | 4  |
| 28-21              | A              | 37             |              |   |   |    | 37 |
| 28-22              | D              | 6              |              | 3 |   |    | 3  |

| Insert Arrangement | Service Rating | Total Contacts | Contact Size |   |   |    |    |
|--------------------|----------------|----------------|--------------|---|---|----|----|
|                    |                |                | 0            | 4 | 8 | 12 | 16 |
| 32-1               | E/D            | 5              | 2            |   |   | 3  |    |
| 32-2               | E              | 5              |              | 3 |   |    | 2  |
| 32-3               | D              | 9              | 1            | 2 |   | 2  | 4  |
| 32-4               | A/D            | 14             |              |   |   | 2  | 12 |
| 32-5               | D              | 2              | 2            |   |   |    |    |
| 32-6               | A              | 23             |              | 2 | 3 | 2  | 16 |
| 32-7               | Inst./A        | 35             |              |   |   | 7  | 28 |
| 32-8               | A              | 30             |              |   |   | 6  | 24 |
| 32-9               | D              | 14             |              | 2 |   |    | 12 |
| 32-10              | E/B/D/A        | 7              |              | 2 | 2 |    | 3  |
| 32-12              | A/D            | 15             |              |   |   | 5  | 10 |
| 32-13              | D              | 23             |              |   |   | 5  | 18 |
| 32-15              | D              | 8              | 2            |   |   | 6  |    |
| 32-16              | A              | 23             |              | 2 | 3 | 2  | 16 |
| 32-17              | D              | 4              |              | 4 |   |    |    |
| 32-22              | A              | 54             |              |   |   |    | 54 |
| 36-1               | D              | 22             |              |   |   | 4  | 18 |
| 36-3               | D              | 6              | 3            |   |   | 3  |    |
| 36-4               | D/A            | 3              | 3            |   |   |    |    |
| 36-5               | A              | 4              | 4            |   |   |    |    |
| 36-6               | A              | 6              | 2            | 4 |   |    |    |
| 36-7               | A              | 47             |              |   |   | 7  | 40 |
| 36-8               | A              | 47             |              |   |   | 1  | 46 |
| 36-9               | A              | 31             |              | 1 | 2 | 14 | 14 |
| 36-10              | A              | 48             |              |   |   |    | 48 |
| 36-11              | A              | 48             |              |   |   |    | 48 |
| 36-12              | A              | 48             |              |   |   |    | 48 |
| 36-13              | E/A            | 17             |              |   |   | 2  | 15 |
| 36-14              | D              | 16             |              |   | 5 | 5  | 6  |
| 36-15              | D/A            | 35             |              |   |   |    | 35 |
| 36-16              | A              | 47             |              |   |   | 7  | 40 |
| 36-17              | A              | 47             |              |   |   | 7  | 40 |
| 36-18              | A              | 31             |              | 1 | 2 | 14 | 14 |
| 36-20              | A              | 34             |              |   | 2 | 2  | 30 |
| 36-52              | A              | 52             |              |   |   |    | 52 |
| 40-1               | D              | 30             |              |   |   | 6  | 24 |
| 40-9               | A              | 47             |              |   | 1 | 22 | 24 |
| 40-56              | A              | 85             |              |   |   |    | 85 |
| 48-62              | D              | 85             |              |   |   |    | 85 |





# MS/Standard insert alternate positioning

To avoid cross-plugging problems in applications requiring the use of more than one connector of the same size and arrangement, alternate rotations are available as indicated in the accompanying charts.

As shown in the diagram below, the front face of the pin insert is rotated within the shell in a clockwise direction from the normal shell key. The socket insert would be rotated counter-clockwise the same number of degrees in respect to the normal shell key.



The following insert arrangements have the same alternate insert rotations for W, X, Y and Z, which are:

| Degrees |     |     |     |
|---------|-----|-----|-----|
| W       | X   | Y   | Z   |
| 80      | 110 | 250 | 280 |

|       |       |       |       |       |       |
|-------|-------|-------|-------|-------|-------|
| 16-7  | 20-22 | 22-29 | 24-17 | 28-16 | 32-13 |
| 18-5  | 22-6  | 22-33 | 24-20 | 28-17 | 32-22 |
| 18-9  | 22-12 | 22-34 | 24-21 | 28-19 | 32-AF |
| 18-13 | 22-14 | 24-1  | 24-28 | 28-20 | 36-1  |
| 18-14 | 22-15 | 24-3  | 28-1  | 28-21 | 36-7  |
| 20-7  | 22-16 | 24-4  | 28-4  | 32-1  | 36-8  |
| 20-8  | 22-17 | 24-5  | 28-8  | 32-3  | 36-13 |
| 20-9  | 22-18 | 24-6  | 28-9  | 32-4  | 40-AR |
| 20-12 | 22-19 | 24-7  | 28-10 | 32-6  | 40-AS |
| 20-14 | 22-21 | 24-12 | 28-11 | 32-9  | 40-AT |
| 20-16 | 22-24 | 24-14 | 28-14 | 32-10 | 40-AU |
| 20-20 | 22-25 | 24-16 | 28-15 | 32-12 |       |

| Insert Arrangement | Degrees |     |     |     |
|--------------------|---------|-----|-----|-----|
|                    | W       | X   | Y   | Z   |
| 10SL-4             | 63      | -   | -   | -   |
| 12S-3              | 70      | 145 | 215 | 290 |
| 14S-2              | -       | 120 | 240 | -   |
| 14S-5              | -       | 110 | -   | -   |
| 14S-7              | 90      | 180 | 270 | -   |
| 14S-9              | 70      | 145 | 215 | 290 |
| 16-9               | 35      | 110 | 250 | 325 |
| 16-10              | 90      | 180 | 270 | -   |
| 16-11              | 35      | 110 | 250 | 325 |
| 16-13              | 35      | 110 | 250 | 325 |
| 16S-1              | 80      | -   | -   | 280 |
| 16S-4              | 35      | 110 | 250 | 325 |
| 16S-5              | 70      | 145 | 215 | 290 |
| 16S-6              | 90      | 180 | 270 | -   |
| 16S-8              | -       | 170 | 265 | -   |
| 18-1               | 70      | 145 | 215 | 290 |
| 18-3               | 35      | 110 | 250 | 325 |
| 18-4               | 35      | 110 | 250 | 325 |
| 18-8               | 70      | -   | -   | 290 |
| 18-10              | -       | 120 | 240 | -   |
| 18-11              | -       | 170 | 265 | -   |
| 18-12              | 80      | -   | -   | 280 |
| 18-15              | -       | 120 | 240 | -   |
| 18-20              | 90      | 180 | 270 | -   |
| 18-22              | 70      | 145 | 215 | 290 |
| 18-29              | 90      | 180 | 270 | -   |
| 20-3               | 70      | 145 | 215 | 290 |
| 20-4               | 45      | 110 | 250 | -   |
| 20-5               | 35      | 110 | 250 | 325 |
| 20-6               | 70      | 145 | 215 | 290 |
| 20-15              | 80      | -   | -   | 280 |
| 20-17              | 90      | 180 | 270 | -   |
| 20-18              | 35      | 110 | 250 | 325 |
| 20-19              | 90      | 180 | 270 | -   |
| 20-21              | 35      | 110 | 250 | 325 |

| Insert Arrangement | Degrees |     |     |     |
|--------------------|---------|-----|-----|-----|
|                    | W       | X   | Y   | Z   |
| 20-23              | 35      | 110 | 250 | 325 |
| 20-24              | 35      | 110 | 250 | 325 |
| 20-27              | 35      | 110 | 250 | 325 |
| 20-29              | 80      | -   | -   | 280 |
| 22-1               | 35      | 110 | 250 | 325 |
| 22-2               | 70      | 145 | 215 | 290 |
| 22-4               | 35      | 110 | 250 | 325 |
| 22-5               | 35      | 110 | 250 | 325 |
| 22-8               | 35      | 110 | 250 | 325 |
| 22-9               | 70      | 145 | 215 | 290 |
| 22-10              | 35      | 110 | 250 | 325 |
| 22-11              | 35      | 110 | 250 | 325 |
| 22-13              | 35      | 110 | 250 | 325 |
| 22-20              | 35      | 110 | 250 | 325 |
| 22-22              | -       | 110 | 250 | -   |
| 22-23              | 35      | -   | 250 | -   |
| 22-27              | 80      | -   | 250 | 280 |
| 22-28              | 80      | -   | -   | 280 |
| 22-63              | 20      | -   | -   | -   |
| 24-2               | 80      | -   | -   | 280 |
| 24-9               | 35      | 110 | 250 | 325 |
| 24-10              | 80      | -   | -   | 280 |
| 24-11              | 35      | 110 | 250 | 325 |
| 24-22              | 45      | 110 | 250 | -   |
| 24-27              | 80      | -   | -   | 280 |
| 28-2               | 35      | 110 | 250 | 325 |
| 28-3               | 70      | 145 | 215 | 290 |
| 28-5               | 35      | 110 | 250 | 325 |
| 28-6               | 70      | 145 | 215 | 290 |
| 28-7               | 35      | 110 | 250 | 325 |
| 28-12              | 90      | 180 | 270 | -   |
| 28-18              | 70      | 145 | 215 | 290 |
| 28-22              | 70      | 145 | 215 | 290 |
| 28-AY              | 45      | 110 | 250 | -   |
| 32-2               | 70      | 145 | 215 | 290 |





| Insert Arrangement | Degrees |     |     |     |
|--------------------|---------|-----|-----|-----|
|                    | W       | X   | Y   | Z   |
| 32-5               | 35      | 110 | 250 | 325 |
| 32-7               | 80      | 125 | 235 | 280 |
| 32-8               | 80      | 125 | 235 | 280 |
| 32-14              | 65      | 130 | 230 | 295 |
| 32-15              | 35      | 110 | 250 | 280 |
| 32-17              | 45      | 110 | 250 | -   |
| 32-25              | 60      | 120 | -   | -   |
| 32-48              | 80      | -   | -   | -   |
| 32-64              | 80      | 100 | 110 | 250 |
| 32-68              | 30      | -   | -   | -   |
| 32-82              | 30      | -   | -   | -   |
| 36-3               | 70      | 145 | 215 | 290 |
| 36-4               | 70      | 145 | 215 | 290 |
| 36-5               | -       | 120 | 240 | -   |
| 36-6               | 35      | 110 | 250 | 325 |
| 36-9               | 80      | 125 | 235 | 280 |
| 36-10              | 80      | 125 | 235 | 280 |
| 36-14              | 90      | 180 | 270 | -   |
| 36-15              | 60      | 125 | 245 | 305 |
| 36-AF              | 65      | -   | -   | -   |
| 40-1               | 65      | 130 | 235 | 300 |
| 40-5               | 33      | -   | -   | 270 |
| 40-9               | 65      | 125 | 225 | 310 |
| 40-10              | 65      | 125 | 225 | 310 |
| 40-35              | 70      | 130 | 230 | 290 |
| 40-AD              | 45      | -   | -   | -   |
| 40-AG              | 37      | 74  | 285 | 322 |
| 40-AP              | 35      | 110 | 250 | 325 |
| 40-AV              | 90      | 180 | 270 | -   |



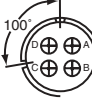
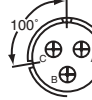

# MS/Standard contact arrangements

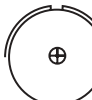
front face of pin insert or rear face of socket insert illustrated

|                           |   |   |   |   |   |   |   |
|---------------------------|---|---|---|---|---|---|---|
|                           |  |  |  |  |  |  |  |
|                           |   |   | Front of<br>Socket Insert   | Front of<br>Socket Insert   |   |   |   |
| <b>Insert Arrangement</b> | <b>8S-1</b>   | <b>10S-2</b>  | <b>10SL-3</b>   | <b>10SL-4</b>   | <b>12S-3</b>  | <b>12S-4</b>  | <b>12-5</b>   |
| <b>Service Rating</b>     | <b>A</b>  | <b>A</b>  | <b>A</b>  | <b>A</b>  | <b>A</b>  | <b>D</b>  | <b>D</b>  |
| <b>Number of Contacts</b> | <b>1</b>  | <b>1</b>  | <b>3</b>  | <b>2</b>  | <b>2</b>  | <b>1</b>  | <b>1</b>  |
| <b>Contact Size</b>       | <b>16</b>   | <b>16</b>   | <b>16</b>   | <b>16</b>   | <b>16</b>   | <b>16</b>   | <b>12</b>   |

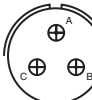
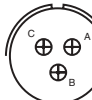
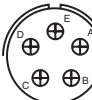
|                           |   |   |   |   |   |   |   |
|---------------------------|---|---|---|---|---|---|---|
|                           |  |  |  |  |  |  |  |
| <b>Insert Arrangement</b> | <b>14S-1</b>  | <b>14S-2</b>  | <b>14S-4</b>  | <b>14S-5</b>  | <b>14S-6</b>  | <b>14S-7</b>  | <b>14S-9</b>  |
| <b>Service Rating</b>     | <b>A</b>  | <b>Inst.</b>  | <b>D</b>  | <b>Inst.</b>  | <b>Inst.</b>  | <b>A</b>  | <b>A</b>  |
| <b>Number of Contacts</b> | <b>3</b>  | <b>4</b>  | <b>1</b>  | <b>5</b>  | <b>6</b>  | <b>3</b>  | <b>2</b>  |
| <b>Contact Size</b>       | <b>16</b>   | <b>16</b>   | <b>16</b>   | <b>16</b>   | <b>16</b>   | <b>16</b>   | <b>16</b>   |

|                           |   |   |   |  |   |   |
|---------------------------|---|---|---|--|---|---|
|                           |  |  |  |  |  |  |
|                           | 100° Rotation<br>of 14S-2   | 100° Rotation<br>of 14S-7   |   |  |   |   |
| <b>Insert Arrangement</b> | <b>14S-10</b>   | <b>14S-12</b>   | <b>14-3</b>   | <b>16S-1</b>   | <b>16S-3</b>  | <b>16S-4</b>  |
| <b>Service Rating</b>     | <b>Inst.</b>  | <b>A</b>  | <b>A</b>  | <b>A</b>   | <b>B</b>  | <b>D</b>  |
| <b>Number of Contacts</b> | <b>4</b>  | <b>3</b>  | <b>1</b>  | <b>7</b>   | <b>1</b>  | <b>2</b>  |
| <b>Contact Size</b>       | <b>16</b>   | <b>16</b>   | <b>8</b>  | <b>16</b>  | <b>16</b>   | <b>16</b>   |

|                           |   |   |   |  |   |   |
|---------------------------|---|---|---|--|---|---|
|                           |  |  |  |  |  |  |
| <b>Insert Arrangement</b> | <b>16S-5</b>  | <b>16S-6</b>  | <b>16S-8</b>  | <b>16-2</b>  | <b>16-7</b>   | <b>16-9</b>   |
| <b>Service Rating</b>     | <b>A</b>  | <b>A</b>  | <b>A</b>  | <b>E</b>   | <b>A</b>  | <b>A</b>  |
| <b>Number of Contacts</b> | <b>3</b>  | <b>3</b>  | <b>5</b>  | <b>1</b>   | <b>1 2</b>  | <b>2 2</b>  |
| <b>Contact Size</b>       | <b>16</b>   | <b>16</b>   | <b>16</b>   | <b>12</b>  | <b>8 16</b>   | <b>12 16</b>  |

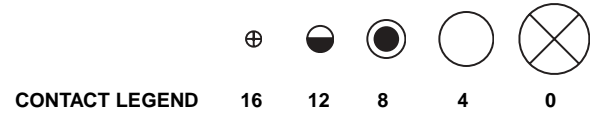

# MS/Standard contact arrangements

front face of pin insert or rear face of socket insert illustrated

|                           |              |              |              |              |                                     |                                     |
|---------------------------|--------------|--------------|--------------|--------------|-------------------------------------|-------------------------------------|
|                           |              |              |              |              |                                     |                                     |
| <b>Insert Arrangement</b> | <b>16-10</b> | <b>16-11</b> | <b>16-12</b> | <b>16-13</b> | <b>18-1</b>                         | <b>18-3</b>                         |
| <b>Service Rating</b>     | <b>A</b>     | <b>A</b>     | <b>A</b>     | <b>A</b>     | <b>B, C, F, G = A; Bal. = Inst.</b> | <b>D</b>                            |
| <b>Number of Contacts</b> | <b>3</b>     | <b>2</b>     | <b>1</b>     | <b>2*</b>    | <b>10</b>                           | <b>2</b>                            |
| <b>Contact Size</b>       | <b>12</b>    | <b>12</b>    | <b>4</b>     | <b>12</b>    | <b>16</b>                           | <b>12</b>                           |
|                           |              |              |              |              |                                     |                                     |
| <b>Insert Arrangement</b> | <b>18-4</b>  | <b>18-5</b>  | <b>18-6</b>  | <b>18-7</b>  | <b>18-8</b>                         | <b>18-9</b>                         |
| <b>Service Rating</b>     | <b>D</b>     | <b>D</b>     | <b>D</b>     | <b>B</b>     | <b>A</b>                            | <b>Inst.</b>                        |
| <b>Number of Contacts</b> | <b>4</b>     | <b>2 1</b>   | <b>1</b>     | <b>1</b>     | <b>1 7</b>                          | <b>2 5</b>                          |
| <b>Contact Size</b>       | <b>16</b>    | <b>12 16</b> | <b>4</b>     | <b>8</b>     | <b>12 16</b>                        | <b>12 16</b>                        |
|                           |              |              |              |              |                                     |                                     |
| <b>Insert Arrangement</b> | <b>18-10</b> | <b>18-11</b> | <b>18-12</b> | <b>18-13</b> | <b>18-14</b>                        | <b>18-15</b>                        |
| <b>Service Rating</b>     | <b>A</b>     | <b>A</b>     | <b>A</b>     | <b>A</b>     | <b>A</b>                            | <b>A</b>                            |
| <b>Number of Contacts</b> | <b>4</b>     | <b>5</b>     | <b>6</b>     | <b>1 3</b>   | <b>1 1</b>                          | <b>4**</b>                          |
| <b>Contact Size</b>       | <b>12</b>    | <b>12</b>    | <b>16</b>    | <b>8 12</b>  | <b>4 16</b>                         | <b>12</b>                           |
|                           |              |              |              |              |                                     |                                     |
| <b>Insert Arrangement</b> | <b>18-16</b> | <b>18-17</b> | <b>18-19</b> | <b>18-20</b> | <b>18-22</b>                        | <b>18-24</b>                        |
| <b>Service Rating</b>     | <b>C</b>     | <b>Inst.</b> | <b>A</b>     | <b>A</b>     | <b>D</b>                            | <b>B, C, F, G = A; Bal. = Inst.</b> |
| <b>Number of Contacts</b> | <b>1</b>     | <b>2 5</b>   | <b>10</b>    | <b>5</b>     | <b>3</b>                            | <b>10</b>                           |
| <b>Contact Size</b>       | <b>12</b>    | <b>12 16</b> | <b>16</b>    | <b>16</b>    | <b>16</b>                           | <b>16</b>                           |

\* A = Iron; B = Constantan  
\*\* A, C = Iron; B, D = Constantan



# MS/Standard contact arrangements

front face of pin insert or rear face of socket insert illustrated



|                    |       |       |       |      |      |      |
|--------------------|-------|-------|-------|------|------|------|
| Insert Arrangement | 18-29 | 18-30 | 18-31 | 20-2 | 20-3 | 20-4 |
| Service Rating     | A     | A     | A     | D    | D    | D    |
| Number of Contacts | 5     | 5     | 5     | 1    | 3    | 4    |
| Contact Size       | 16    | 16    | 16    | 0    | 12   | 12   |



|                    |      |                                |       |                 |       |       |
|--------------------|------|--------------------------------|-------|-----------------|-------|-------|
| Insert Arrangement | 20-6 | 20-7                           | 20-8  | 20-9            | 20-11 | 20-12 |
| Service Rating     | D    | A, B, H, G = D; C, D, E, F = A | Inst. | H = D; Bal. = A | Inst. | A     |
| Number of Contacts | 3    | 8                              | 2 4   | 1 7             | 13    | 1 1   |
| Contact Size       | 16   | 16                             | 8 16  | 12 16           | 16    | 4 16  |



|                    |       |       |       |       |       |       |
|--------------------|-------|-------|-------|-------|-------|-------|
| Insert Arrangement | 20-14 | 20-15 | 20-16 | 20-17 | 20-18 | 20-19 |
| Service Rating     | A     | A     | A     | A     | A     | A     |
| Number of Contacts | 2 3   | 7     | 2 7   | 5 1   | 3 6   | 3     |
| Contact Size       | 8 12  | 12    | 12 16 | 12 16 | 12 16 | 8     |



CONTACT LEGEND 16 12 8 4 0

# MS/Standard contact arrangements

front face of pin insert or rear face of socket insert illustrated



|                    |              |              |              |              |              |              |
|--------------------|--------------|--------------|--------------|--------------|--------------|--------------|
| Insert Arrangement | <b>20-20</b> | <b>20-21</b> | <b>20-22</b> | <b>20-23</b> | <b>20-24</b> | <b>20-25</b> |
| Service Rating     | <b>A</b>     | <b>A</b>     | <b>A</b>     | <b>A</b>     | <b>A</b>     | <b>Inst.</b> |
| Number of Contacts | <b>1 3</b>   | <b>1 8</b>   | <b>3 3</b>   | <b>2</b>     | <b>2 2</b>   | <b>13</b>    |
| Contact Size       | <b>4 12</b>  | <b>12 16</b> | <b>8 16</b>  | <b>8</b>     | <b>8 16</b>  | <b>16</b>    |



|                    |              |              |              |              |             |             |
|--------------------|--------------|--------------|--------------|--------------|-------------|-------------|
| Insert Arrangement | <b>20-27</b> | <b>20-29</b> | <b>20-30</b> | <b>20-33</b> | <b>22-1</b> | <b>22-2</b> |
| Service Rating     | <b>A</b>     | <b>A</b>     | <b>Inst.</b> | <b>A</b>     | <b>D</b>    | <b>D</b>    |
| Number of Contacts | <b>14</b>    | <b>17</b>    | <b>13</b>    | <b>11</b>    | <b>2</b>    | <b>3</b>    |
| Contact Size       | <b>16</b>    | <b>16</b>    | <b>16</b>    | <b>16</b>    | <b>8</b>    | <b>8</b>    |



|                    |             |              |             |             |             |
|--------------------|-------------|--------------|-------------|-------------|-------------|
| Insert Arrangement | <b>22-4</b> | <b>22-5</b>  | <b>22-6</b> | <b>22-7</b> | <b>22-8</b> |
| Service Rating     | <b>A</b>    | <b>D</b>     | <b>D</b>    | <b>E</b>    | <b>E</b>    |
| Number of Contacts | <b>2 2</b>  | <b>2 4</b>   | <b>2 1</b>  | <b>1</b>    | <b>2</b>    |
| Contact Size       | <b>8 12</b> | <b>12 16</b> | <b>8 16</b> | <b>0</b>    | <b>12</b>   |



# MS/Standard contact arrangements

front face of pin insert or rear face of socket insert illustrated

|                           |             |              |              |              |                              |
|---------------------------|-------------|--------------|--------------|--------------|------------------------------|
|                           |             |              |              |              |                              |
| <b>Insert Arrangement</b> | <b>22-9</b> | <b>22-10</b> | <b>22-11</b> | <b>22-12</b> | <b>22-13</b>                 |
| <b>Service Rating</b>     | <b>E</b>    | <b>E</b>     | <b>B</b>     | <b>D</b>     | <b>E = D; A, B, C, D = A</b> |
| <b>Number of Contacts</b> | <b>3</b>    | <b>4</b>     | <b>2</b>     | <b>2 3</b>   | <b>4 1</b>                   |
| <b>Contact Size</b>       | <b>12</b>   | <b>16</b>    | <b>16</b>    | <b>8 16</b>  | <b>12 16</b>                 |

|                           |              |                                 |              |                        |                                       |
|---------------------------|--------------|---------------------------------|--------------|------------------------|---------------------------------------|
|                           |              |                                 |              |                        |                                       |
| <b>Insert Arrangement</b> | <b>22-14</b> | <b>22-15</b>                    | <b>22-16</b> | <b>22-17</b>           | <b>22-18</b>                          |
| <b>Service Rating</b>     | <b>A</b>     | <b>D = E; A, B, C, E, F = A</b> | <b>A</b>     | <b>A = D; Bal. = A</b> | <b>A, B, F, G, H = D; C, D, E = A</b> |
| <b>Number of Contacts</b> | <b>19</b>    | <b>5 1</b>                      | <b>3 6</b>   | <b>1 8</b>             | <b>8</b>                              |
| <b>Contact Size</b>       | <b>16</b>    | <b>12 16</b>                    | <b>12 16</b> | <b>12 16</b>           | <b>16</b>                             |

|                           |              |              |              |              |                        |
|---------------------------|--------------|--------------|--------------|--------------|------------------------|
|                           |              |              |              |              |                        |
| <b>Insert Arrangement</b> | <b>22-19</b> | <b>22-20</b> | <b>22-21</b> | <b>22-22</b> | <b>22-23</b>           |
| <b>Service Rating</b>     | <b>A</b>     | <b>A</b>     | <b>A</b>     | <b>A</b>     | <b>H = D; Bal. = A</b> |
| <b>Number of Contacts</b> | <b>14</b>    | <b>9</b>     | <b>1 2</b>   | <b>4</b>     | <b>8</b>               |
| <b>Contact Size</b>       | <b>16</b>    | <b>16</b>    | <b>0 16</b>  | <b>8</b>     | <b>12</b>              |



# MS/Standard contact arrangements

front face of pin insert or rear face of socket insert illustrated

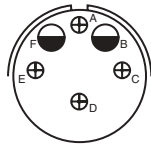

**22-24**  
Service Rating C, D, E = D; A, B, F = A  
Number of Contacts 2 4  
Contact Size 12 16

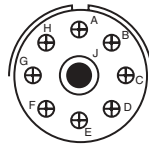

**22-27**  
Service Rating J = D; Bal. = A  
Number of Contacts 1 8  
Contact Size 8 16

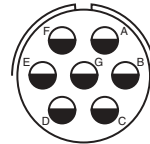

**22-28**  
Service Rating A  
Number of Contacts 7  
Contact Size 12

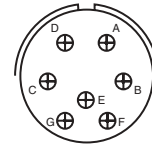

**22-33**  
Service Rating A, B, C, D = D; E, F, G = A  
Number of Contacts 7  
Contact Size 16

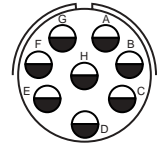

**22-36**  
Service Rating H = D; Bal. = A\*  
Number of Contacts 8  
Contact Size 12

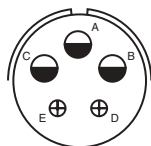

**22-34**  
Service Rating D  
Number of Contacts 3 2  
Contact Size 12 16

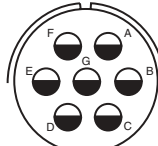

**24-2**  
Service Rating D  
Number of Contacts 7  
Contact Size 12

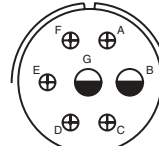

**24-3**  
Service Rating D  
Number of Contacts 2 5  
Contact Size 12 16

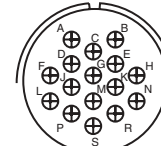

**24-5**  
Service Rating A  
Number of Contacts 16  
Contact Size 16

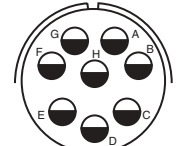

**24-6**  
Service Rating A, G, H = D; Bal. = A  
Number of Contacts 8  
Contact Size 12

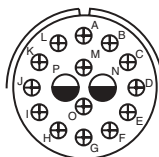

**24-7**  
Service Rating A  
Number of Contacts 2 14  
Contact Size 12 16

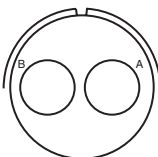

**24-9**  
Service Rating A  
Number of Contacts 2  
Contact Size 4

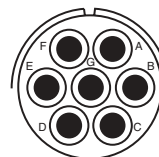

**24-10**  
Service Rating A  
Number of Contacts 7  
Contact Size 8

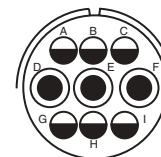

**24-11**  
Service Rating A  
Number of Contacts 3 6  
Contact Size 8 12

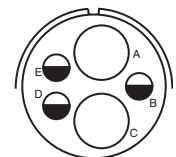

**24-12**  
Service Rating A  
Number of Contacts 2 3  
Contact Size 4 12

\* A, C, E, G = Iron  
B, D, F, H = Constantan





# MS/Standard contact arrangements

front face of pin insert or rear face of socket insert illustrated



|                    |                              |  |
|--------------------|------------------------------|--|
| Insert Arrangement | 24-16                        |  |
| Service Rating     | A, B, F, G = D; C, D, E, = A |  |
| Number of Contacts | 1 3 3                        |  |
| Contact Size       | 8 12 16                      |  |

|                    |       |  |
|--------------------|-------|--|
| Insert Arrangement | 24-17 |  |
| Service Rating     | D     |  |
| Number of Contacts | 2 3   |  |
| Contact Size       | 12 16 |  |

|                    |       |  |
|--------------------|-------|--|
| Insert Arrangement | 24-20 |  |
| Service Rating     | D     |  |
| Number of Contacts | 2 9   |  |
| Contact Size       | 12 16 |  |

|                    |       |  |
|--------------------|-------|--|
| Insert Arrangement | 24-21 |  |
| Service Rating     | D     |  |
| Number of Contacts | 1 9   |  |
| Contact Size       | 8 16  |  |

|                    |       |  |
|--------------------|-------|--|
| Insert Arrangement | 24-22 |  |
| Service Rating     | D     |  |
| Number of Contacts | 4     |  |
| Contact Size       | 8     |  |



|                    |       |  |
|--------------------|-------|--|
| Insert Arrangement | 24-27 |  |
| Service Rating     | E     |  |
| Number of Contacts | 7     |  |
| Contact Size       | 16    |  |

|                    |       |  |
|--------------------|-------|--|
| Insert Arrangement | 24-28 |  |
| Service Rating     | Inst. |  |
| Number of Contacts | 24    |  |
| Contact Size       | 16    |  |

|                    |                       |  |
|--------------------|-----------------------|--|
| Insert Arrangement | 28-1                  |  |
| Service Rating     | A, J, E = D; Bal. = A |  |
| Number of Contacts | 3 6                   |  |
| Contact Size       | 8 12                  |  |

|                    |       |  |
|--------------------|-------|--|
| Insert Arrangement | 28-2  |  |
| Service Rating     | D     |  |
| Number of Contacts | 2 12  |  |
| Contact Size       | 12 16 |  |

|                    |      |  |
|--------------------|------|--|
| Insert Arrangement | 28-3 |  |
| Service Rating     | E    |  |
| Number of Contacts | 3    |  |
| Contact Size       | 8    |  |



|                    |                       |  |
|--------------------|-----------------------|--|
| Insert Arrangement | 28-4                  |  |
| Service Rating     | G, P, S = E; Bal. = D |  |
| Number of Contacts | 2 7                   |  |
| Contact Size       | 12 16                 |  |

|                    |         |  |
|--------------------|---------|--|
| Insert Arrangement | 28-5    |  |
| Service Rating     | D       |  |
| Number of Contacts | 2 1 2   |  |
| Contact Size       | 4 12 16 |  |

|                    |      |  |
|--------------------|------|--|
| Insert Arrangement | 28-6 |  |
| Service Rating     | D    |  |
| Number of Contacts | 3    |  |
| Contact Size       | 4    |  |

|                    |      |  |
|--------------------|------|--|
| Insert Arrangement | 28-7 |  |
| Service Rating     | D    |  |
| Number of Contacts | 2    |  |
| Contact Size       | 4    |  |



# MS/Standard contact arrangements

front face of pin insert or rear face of socket insert illustrated



|                           |                           |
|---------------------------|---------------------------|
| <b>Insert Arrangement</b> | <b>28-8</b>               |
| <b>Service Rating</b>     | L, M = E; B = D; Bal. = A |
| <b>Number of Contacts</b> | 2 10                      |
| <b>Contact Size</b>       | 12 16                     |

|             |
|-------------|
| <b>28-9</b> |
| D           |
| 6 6         |
| 12 16       |

|                 |
|-----------------|
| <b>28-10</b>    |
| G = D; Bal. = A |
| 2 2 3           |
| 4 8 12          |

|              |
|--------------|
| <b>28-11</b> |
| A            |
| 4 18         |
| 12 16        |



|                           |              |
|---------------------------|--------------|
| <b>Insert Arrangement</b> | <b>28-12</b> |
| <b>Service Rating</b>     | A            |
| <b>Number of Contacts</b> | 26           |
| <b>Contact Size</b>       | 16           |

100° Rotation  
of 28-12

|              |
|--------------|
| <b>28-13</b> |
| A            |
| 26           |
| 16           |

|              |
|--------------|
| <b>28-15</b> |
| A            |
| 35           |
| 16           |

|              |
|--------------|
| <b>28-16</b> |
| A            |
| 20           |
| 16           |



|                           |                                |
|---------------------------|--------------------------------|
| <b>Insert Arrangement</b> | <b>28-17</b>                   |
| <b>Service Rating</b>     | R = B; M, N, P = D; A to L = A |
| <b>Number of Contacts</b> | 15                             |
| <b>Contact Size</b>       | 16                             |

|  |
|--|
| <b>28-18</b>                                     |
| M = C; G, H, J, K, L = D; A, B = A; Bal. = Inst. |
| 12   |
| 16   |

|                              |
|------------------------------|
| <b>28-19</b>                 |
| H, M = B; A, B = D; Bal. = A |
| 4 6                          |
| 12 16                        |



# MS/Standard contact arrangements

front face of pin insert or rear face of socket insert illustrated

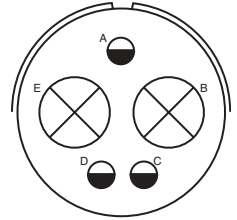
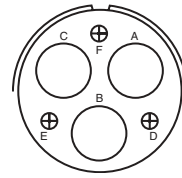
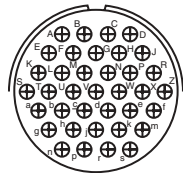

Insert Arrangement  
Service Rating  
Number of Contacts  
Contact Size

**28-20**  
**A**  
**10 4**  
**12 16**

**28-21**  
**A**  
**37**  
**16**

**28-22**  
**D**  
**3 3**  
**4 16**

**32-1**  
**A = E; B, C, D, E = D**  
**2 3**  
**0 12**

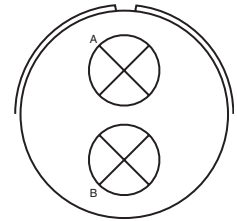
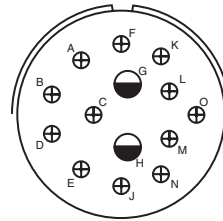
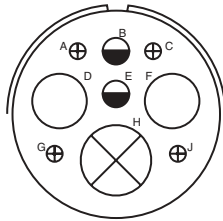
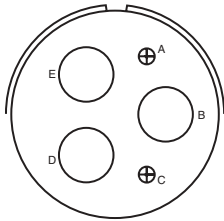

Insert Arrangement  
Service Rating  
Number of Contacts  
Contact Size

**32-2**  
**E**  
**3 2**  
**4 16**

**32-3**  
**D**  
**1 2 2 4**  
**0 4 12 16**

**32-4**  
**F, J, K, N = A; Bal. = D**  
**2 12**  
**12 16**

**32-5**  
**D**  
**2**  
**0**

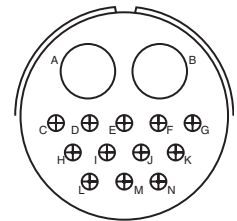
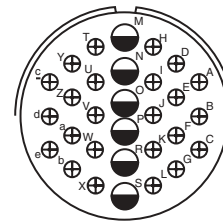
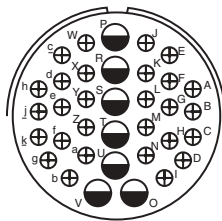
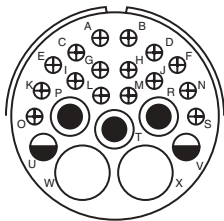

Insert Arrangement  
Service Rating  
Number of Contacts  
Contact Size

**32-6**  
**A**  
**2 3 2 16**  
**4 8 12 16**

**32-7**  
**A, B, h, j = Inst.; Bal. = A**  
**7 28**  
**12 16**

**32-8**  
**A**  
**6 24**  
**12 16**

**32-9**  
**D**  
**2 12**  
**4 16**

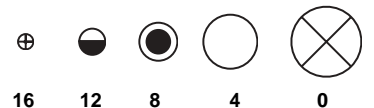

CONTACT LEGEND

16 12 8 4 0

# MS/Standard contact arrangements

front face of pin insert or rear face of socket insert illustrated

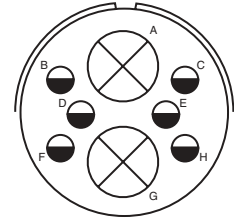
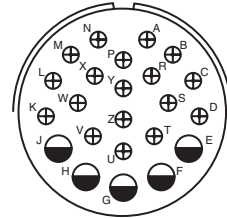
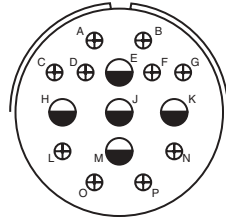

**Insert Arrangement**

**Service Rating**

**Number of Contacts**

**Contact Size**

**32-10**

A, F = E; G = B; B, E = D; C, D = A

2 2 3

4 8 16

**32-12**

C, D, E, F, G = A; Bal. = D

5 10

12 16

**32-13**

D

5 18

12 16

**32-15**

D

2 6

0 12

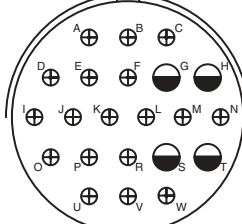
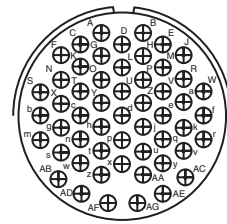
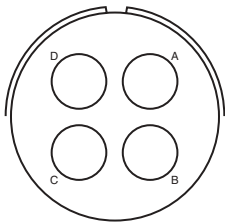

100° Rotation  
of 32-6

**32-16**

A

2 3 2 16

4 8 12 16

**32-17**

D

4

4

**32-22**

A

54

16

**36-1**

D

4 18

12 16

**Insert Arrangement**

**Service Rating**

**Number of Contacts**

**Contact Size**

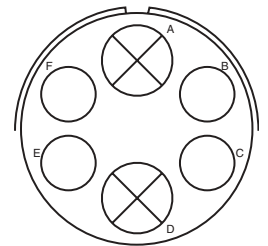
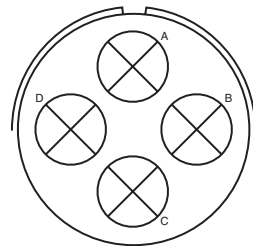
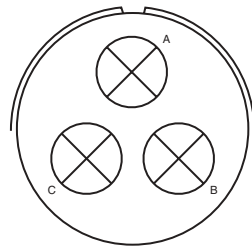
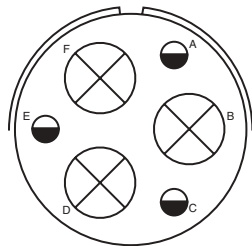

**Insert Arrangement**

**Service Rating**

**Number of Contacts**

**Contact Size**

**36-3**

D

3 3

0 12

**36-4**

A = D; B, C = A

3

0

**36-5**

A

4

0

**36-6**

A

2 4

0 4



**CONTACT LEGEND**

16

12

8

4

0

# MS/Standard contact arrangements

front face of pin insert or rear face of socket insert illustrated

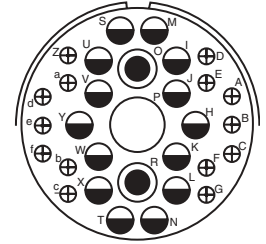
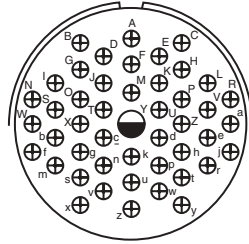
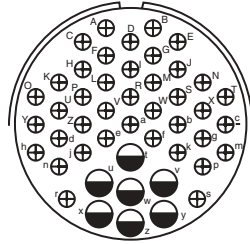

**Insert Arrangement**  
**Service Rating**  
**Number of Contacts**  
**Contact Size**

**36-7**  
**A**  
**7 40**  
**12 16**

**36-8**  
**A**  
**1 46**  
**12 16**

**36-9**  
**A**  
**1 2 14 14**  
**4 8 12 16**

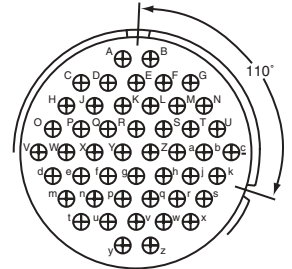
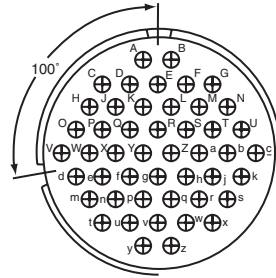
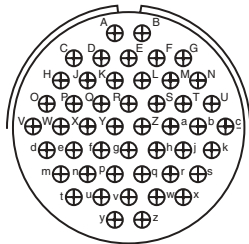

**Insert Arrangement**  
**Service Rating**  
**Number of Contacts**  
**Contact Size**

**36-10**  
**A**  
**48**  
**16**

**100° Rotation  
of 36-10**  
**36-11**  
**A**  
**48**  
**16**

**110° Rotation  
of 36-10**  
**36-12**  
**A**  
**48**  
**16**

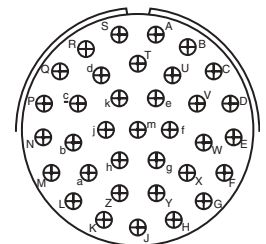
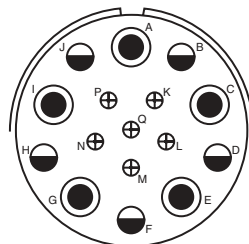
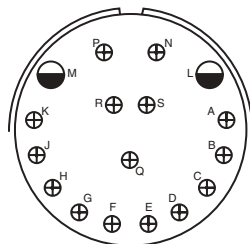

**Insert Arrangement**  
**Service Rating**  
**Number of Contacts**  
**Contact Size**

**36-13**  
**N, P, Q = E; Bal. = A**  
**2 15**  
**12 16**

**36-14**  
**D**  
**5 5 6**  
**8 12 16**

**36-15**  
**M = D; Bal. = A**  
**35**  
**16**

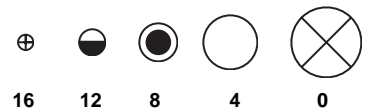

# MS/Standard contact arrangements

front face of pin insert or rear face of socket insert illustrated



100° Rotation  
of 36-7  
**36-16**  
A  
7 40  
12 16

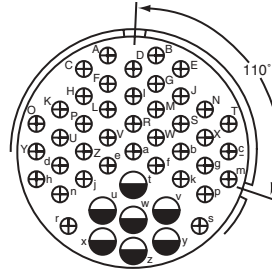

110° Rotation  
of 36-7  
**36-17**  
A  
7 40  
12 16



100° Rotation  
of 36-9  
**36-18**  
A  
1 2 14 14  
4 8 12 16

**Insert Arrangement**  
**Service Rating**  
**Number of Contacts**  
**Contact Size**

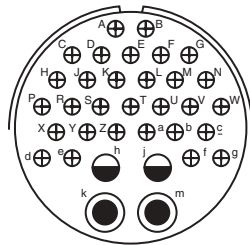

**36-20**  
A  
2 2 30  
8 12 16



**36-52**  
A  
52  
16



**40-1**  
D  
6 24  
12 16

**Insert Arrangement**  
**Service Rating**  
**Number of Contacts**  
**Contact Size**

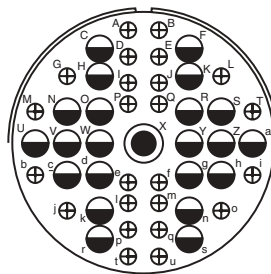

**40-9**  
A  
1 22 24  
8 12 16

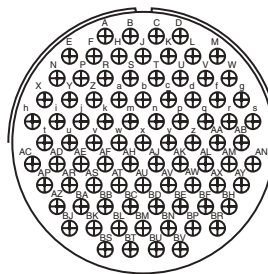

**40-56**  
A  
85  
16

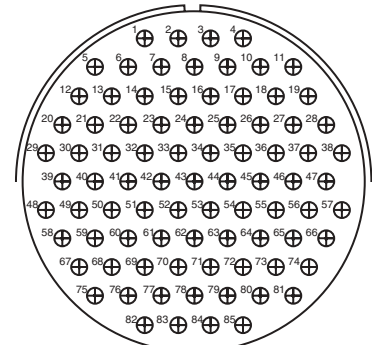

**48-62**  
D  
85  
16

**Insert Arrangement**  
**Service Rating**  
**Number of Contacts**  
**Contact Size**



**CONTACT LEGEND**

16 12 8 4 0

# Special contact arrangements

Requirements for more complex circuits prompted Amphenol to provide inserts not covered by the MS drawings. Illustrated here and on the following pages are insert layouts which have from one contact (high tension) to the 104 contact insert in shell size 44.

Many of these special inserts are also available in alternate keyway arrangements. Please contact Amphenol, Sidney, NY for additional information on special circuit application requirements.

front face of pin insert or rear face of socket insert illustrated

|                           |        |       |       |       |                       |       |
|---------------------------|--------|-------|-------|-------|-----------------------|-------|
|                           |        |       |       |       |                       |       |
| <b>Insert Arrangement</b> | 14S-A7 | 16-59 | 20-26 | 20-51 | 20-57                 | 20-58 |
| <b>Service Rating</b>     | A      | A     | A     | A     | A                     | A     |
| <b>Number of Contacts</b> | 7      | 4     | 19    | 3*    | 7*                    | 5 5   |
| <b>Contact Size</b>       | 16     | 12    | 16    | 8     | 12 for #14 or 16 wire | 12 16 |

|                           |                      |                    |                    |       |                       |       |
|---------------------------|----------------------|--------------------|--------------------|-------|-----------------------|-------|
|                           |                      |                    |                    |       |                       |       |
| <b>Insert Arrangement</b> | 20-59                | 20-66              | 20-79              | 22-63 | 22-65                 | 22-70 |
| <b>Service Rating</b>     | A                    | A                  | H = D; Bal. = A    | A     | H = D; Bal. = A       | A     |
| <b>Number of Contacts</b> | 3*                   | 1 5                | 7* 1*              | 4 8   | 8*                    | 8 5   |
| <b>Contact Size</b>       | 8 for #10 or 12 wire | 16 12 for #10 wire | 16 12 for #16 wire | 12 16 | 12 for #14 or 16 wire | 12 16 |

|                           |                      |       |  |         |       |         |
|---------------------------|----------------------|-------|--|---------|-------|---------|
|                           |                      |       |  |         |       |         |
| <b>Insert Arrangement</b> | 22-80                | 24-19 | 24-51  | 24-52   | 24-53 | 24-58   |
| <b>Service Rating</b>     | A                    | A     | A  | Hi-Volt | A     | A       |
| <b>Number of Contacts</b> | 3*                   | 12    | 5*   | 1       | 5*    | 3 3 7   |
| <b>Contact Size</b>       | 8 for #10 or 12 wire | 16    | B, E for AN #10 or 12 wire<br>A, C, D for AN #8 wire | 12      | 8     | 8 12 16 |

\* Solderless



# Special contact arrangements

front face of pin insert or rear face of socket insert illustrated



|                    |       |                      |       |       |       |
|--------------------|-------|----------------------|-------|-------|-------|
| Insert Arrangement | 24-59 | 24-60                | 24-65 | 24-66 | 24-67 |
| Service Rating     | A     | A                    | A     | D     | Inst. |
| Number of Contacts | 7 7   | 7*                   | 11 4  | 7     | 19    |
| Contact Size       | 12 16 | 8 for #10 or 12 wire | 12 16 | 12    | 12    |



|                    |                        |                  |       |       |                                   |
|--------------------|------------------------|------------------|-------|-------|-----------------------------------|
| Insert Arrangement | 24-71                  | 24-75            | 24-79 | 24-80 | 24-84                             |
| Service Rating     | A                      | A                | A     | Inst. | A                                 |
| Number of Contacts | 2* 5*                  | 5 2              | 5     | 23    | 1 18                              |
| Contact Size       | 8 8 for #10 or 12 wire | 8 8 for #16 wire | 8     | 16    | 12 12 (Coax) RG-188/U or RG-174/U |



|                    |       |       |       |       |
|--------------------|-------|-------|-------|-------|
| Insert Arrangement | 24-96 | 24-AJ | 28-51 | 28-59 |
| Service Rating     | Inst. | A     | A     | A     |
| Number of Contacts | 28    | 25    | 12    | 7 10  |
| Contact Size       | 16    | 16    | 12    | 12 16 |

\* Solderless





# Special contact arrangements

front face of pin insert or rear face of socket insert illustrated



|                    |       |                               |                               |                   |       |
|--------------------|-------|-------------------------------|-------------------------------|-------------------|-------|
| Insert Arrangement | 28-66 | 28-72                         | 28-74                         | 28-75             | 28-79 |
| Service Rating     | A     | -                             | A                             | A                 | A     |
| Number of Contacts | 2 14  | 3                             | 9* 4* 3*                      | 9* 7*             | 7 9   |
| Contact Size       | 8 12  | 4 (Coax) RG-59A/U or RG-62A/U | 16 8 8 for #10 wire (S, T, R) | 16 8 for #10 wire | 8 16  |



|                    |       |       |       |       |       |
|--------------------|-------|-------|-------|-------|-------|
| Insert Arrangement | 28-82 | 28-84 | 28-AY | 32-14 | 32-25 |
| Service Rating     | D     | A     | A     | D     | A     |
| Number of Contacts | 2 4   | 9     | 4 5   | 13    | 25    |
| Contact Size       | 8 12  | 8     | 4 16  | 12    | 12    |



|                    |       |       |       |                        |
|--------------------|-------|-------|-------|------------------------|
| Insert Arrangement | 32-31 | 32-48 | 32-52 | 32-53                  |
| Service Rating     | A     | Inst. | D     | t, u = E; Bal. = Inst. |
| Number of Contacts | 31    | 48    | 6 2   | 5 37                   |
| Contact Size       | 16    | 16    | 12 0  | 12 16                  |

\* Solderless



# Special contact arrangements

front face of pin insert or rear face of socket insert illustrated



|                           |                    |                     |                               |                      |
|---------------------------|--------------------|---------------------|-------------------------------|----------------------|
| <b>Insert Arrangement</b> | <b>32-56</b>       | <b>32-57</b>        | <b>32-58</b>                  | <b>32-59</b>         |
| <b>Service Rating</b>     | A                  | **                  | -                             | A                    |
| <b>Number of Contacts</b> | 24 6               | 6 2                 | 4                             | 40 2                 |
| <b>Contact Size</b>       | 16 12 for #10 wire | 12 0 (Coax) RG-71/U | 4 (Coax) RG-161/U or RG-179/U | 16 8 (Coax) RG-161/U |



|                           |                      |                             |              |                      |
|---------------------------|----------------------|-----------------------------|--------------|----------------------|
| <b>Insert Arrangement</b> | <b>32-60</b>         | <b>32-62</b>                | <b>32-64</b> | <b>32-68</b>         |
| <b>Service Rating</b>     | A                    | **                          | Inst.        | A                    |
| <b>Number of Contacts</b> | 15 8                 | 2 1 2 16 2                  | 54           | 12 4                 |
| <b>Contact Size</b>       | 16 8 (Coax) RG-124/U | 4 8 12 16 8 (Coax) RG-124/U | 16           | 16 4 (Coax) RG-58C/U |

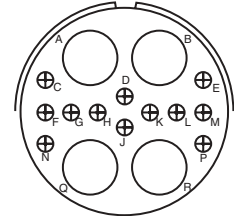

|                           |              |                       |              |              |              |
|---------------------------|--------------|-----------------------|--------------|--------------|--------------|
| <b>Insert Arrangement</b> | <b>32-73</b> | <b>32-75</b>          | <b>32-76</b> | <b>32-79</b> | <b>32-82</b> |
| <b>Service Rating</b>     | A            | 8, 9 = D              | A            | D            | A            |
| <b>Number of Contacts</b> | 46           | 2 7                   | 19           | 4 1          | 4 12         |
| <b>Contact Size</b>       | 16           | 12 8 (Coax) RG-180B/U | 12           | 4 8          | 4 16         |

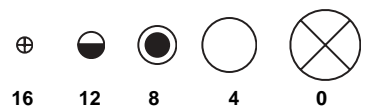

\*\* Consult Amphenol, Sidney, NY for service rating of power contacts.

# Special contact arrangements

front face of pin insert or rear face of socket insert illustrated



|                    |       |       |       |       |
|--------------------|-------|-------|-------|-------|
| Insert Arrangement | 32-AF | 36-22 | 36-51 | 36-54 |
| Service Rating     | A     | D     | D     | A     |
| Number of Contacts | 55    | 22    | 2 2   | 8 31  |
| Contact Size       | 16    | 12    | 0 4   | 8 16  |



|                    |                  |                    |                    |   |
|--------------------|------------------|--------------------|--------------------|---|
| Insert Arrangement | 36-55            | 36-59              | 36-60              | 36-64                                   |
| Service Rating     | A                | A                  | **                 | -                                       |
| Number of Contacts | 31 8             | 50 3               | 40 7               | 4                                       |
| Contact Size       | 16 8 for #6 wire | 16 12 for #10 wire | 16 12 for #10 wire | 0 (Coax) RG-11/U,<br>RG-12/U or RG-13/U |



|                    |   |       |                   |                      |
|--------------------|---|-------|-------------------|----------------------|
| Insert Arrangement | 36-65                                   | 36-71 | 36-73             | 36-74                |
| Service Rating     | -                                       | A     | -                 | A                    |
| Number of Contacts | 4                                       | 3 50  | 7                 | 43 1                 |
| Contact Size       | 0 (Coax) RG-59/U, RG-62/U<br>or RG-71/U | 12 16 | 4 (Coax) RG-62B/U | 16 8 (Coax) RG-187/U |



\*\* Consult Amphenol, Sidney, NY for service rating of power contacts.

# Special contact arrangements

front face of pin insert or rear face of socket insert illustrated



|                           |                        |              |              |              |
|---------------------------|------------------------|--------------|--------------|--------------|
| <b>Insert Arrangement</b> | <b>36-75</b>           | <b>36-76</b> | <b>36-77</b> | <b>36-78</b> |
| <b>Service Rating</b>     | <b>A</b>               | <b>A</b>     | <b>D</b>     | <b>A</b>     |
| <b>Number of Contacts</b> | <b>48</b>              | <b>47</b>    | <b>7</b>     | <b>2 12</b>  |
| <b>Contact Size</b>       | <b>16 for #14 wire</b> | <b>16</b>    | <b>4</b>     | <b>16 8</b>  |



|                           |              |                        |                         |                        |
|---------------------------|--------------|------------------------|-------------------------|------------------------|
| <b>Insert Arrangement</b> | <b>36-79</b> | <b>36-80</b>           | <b>36-83</b>            | <b>36-85</b>           |
| <b>Service Rating</b>     | <b>A</b>     | <b>A</b>               | <b>-</b>                | <b>M = D; Bal. = A</b> |
| <b>Number of Contacts</b> | <b>20</b>    | <b>20</b>              | <b>7</b>                | <b>35</b>              |
| <b>Contact Size</b>       | <b>12</b>    | <b>12 for #10 wire</b> | <b>4 (Coax) RG-58/U</b> | <b>16 for #12 wire</b> |



|                           |              |                  |              |             |
|---------------------------|--------------|------------------|--------------|-------------|
| <b>Insert Arrangement</b> | <b>36-97</b> | <b>36-99</b>     | <b>36-AF</b> | <b>40-5</b> |
| <b>Service Rating</b>     | <b>C</b>     | <b>D</b>         | <b>A</b>     | <b>A</b>    |
| <b>Number of Contacts</b> | <b>1</b>     | <b>3 3 3 3</b>   | <b>48</b>    | <b>5</b>    |
| <b>Contact Size</b>       | <b>4/0</b>   | <b>4 8 12 16</b> | <b>16</b>    | <b>0</b>    |



# Special contact arrangements

front face of pin insert or rear face of socket insert illustrated



| Insert Arrangement | 40-10  | 40-30 | 40-35 | 40-53 |
|--------------------|--------|-------|-------|-------|
| Service Rating     | A      | A     | D     | A     |
| Number of Contacts | 4 9 16 | 29 1  | 35    | 60    |
| Contact Size       | 4 8 16 | 12 4  | 12    | 16    |



| Insert Arrangement | 40-57 | 40-61   | 40-62 |
|--------------------|-------|---------|-------|
| Service Rating     | E     | A       | A     |
| Number of Contacts | 4     | 1 3 55  | 60    |
| Contact Size       | 0     | 8 12 16 | 16    |



| Insert Arrangement | 40-63           | 40-64                   | 40-66             |
|--------------------|-----------------|-------------------------|-------------------|
| Service Rating     | A               | -                       | -                 |
| Number of Contacts | 61              | 3 20 13                 | 4                 |
| Contact Size       | 16 for #14 wire | 12 16 8 (Coax) RG-124/U | 0 (Coax) RG-63B/U |



# Special contact arrangements

front face of pin insert or rear face of socket insert illustrated

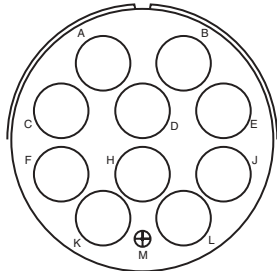

**Insert Arrangement** 40-67  
**Service Rating** A  
**Number of Contacts** 1 10  
**Contact Size** 16 4 (Coax) RG-59/U



**Insert Arrangement** 40-68  
**Service Rating** A  
**Number of Contacts** 21 8



**Insert Arrangement** 40-70  
**Service Rating** A  
**Number of Contacts** 61 16

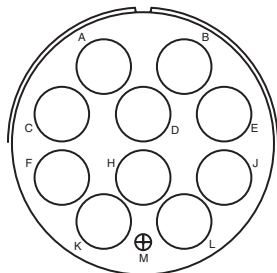

**Insert Arrangement** 40-72  
**Service Rating** A  
**Number of Contacts** 1 10  
**Contact Size** 16 4 (Coax) RG-9B/U



**Insert Arrangement** 40-73  
**Service Rating** A  
**Number of Contacts** 61 16



**Insert Arrangement** 40-74  
**Service Rating** A  
**Number of Contacts** 1 1 4  
**Contact Size** 12 4 (Coax) RG-62/U 0 (Coax) RG-9B/U or RG-214/U



**Insert Arrangement** 40-75  
**Service Rating** E  
**Number of Contacts** 1 4  
**Contact Size** 12 0



**Insert Arrangement** 40-80  
**Service Rating** A  
**Number of Contacts** 1 10  
**Contact Size** 16 4



**Insert Arrangement** 40-81  
**Service Rating** A  
**Number of Contacts** 62  
**Contact Size** 16 for #14 wire



**CONTACT LEGEND**

16 12 8 4 0

# Special contact arrangements

front face of pin insert or rear face of socket insert illustrated



**40-82**

**Insert Arrangement**  
**Service Rating**  
**Number of Contacts**  
**Contact Size**

**A**  
**62**  
**16**



**40-85**

**A**  
**60**  
**16 for #14 wire**



**40-86**

**-**  
**4**  
**0(Coax) RG-115A/U**



**40-87**

**D**  
**7**  
**4**



**40-AD**

**Insert Arrangement**  
**Service Rating**  
**Number of Contacts**  
**Contact Size**

**A**  
**4 4**  
**8 0**



**40-AG**

**A**  
**38**  
**12**



**40-AP**

**E**  
**2**  
**4/0**



**40-AR**

**Inst.**  
**7 3 3**  
**12 4 0**



**40-AS**

**Insert Arrangement**  
**Service Rating**  
**Number of Contacts**  
**Contact Size**

**A**  
**15 25**  
**16 12**



**40-AT**

**A**  
**24 18 1**  
**12 16 8**



**40-AU**

**A**  
**3 10 1**  
**4 8 16**



**40-AV**

**D**  
**3**  
**2/0**



**CONTACT LEGEND**

**16 12 8 4 0 2/0 4/0**

# Special contact arrangements

front face of pin insert or rear face of socket insert illustrated



| Insert Arrangement | 44-52 | 44-53                | 48-51                 |
|--------------------|-------|----------------------|-----------------------|
| Service Rating     | A     | A                    | A                     |
| Number of Contacts | 104   | 18 18                | 42 10 4               |
| Contact Size       | 16    | 16 8 (Coax) RG-124/U | 16 8 0 (Coax) RG-41/U |



| Insert Arrangement | 48-52               | 48-53 |
|--------------------|---------------------|-------|
| Service Rating     | A                   | D     |
| Number of Contacts | 56 5                | 37    |
| Contact Size       | 16 0 (Coax) RG-41/U | 12    |





# Special contact arrangements

front face of pin insert or rear face of socket insert illustrated



**48-54**

**Insert Arrangement**  
**Service Rating**  
**Number of Contacts**  
**Contact Size**

**A**  
**42 10 4**  
**16 8 0 (Coax) RG-59/U**



**48-55**

**A**  
**68 2 2 6**  
**16 12 8 4**



**48-57**

**Insert Arrangement**  
**Service Rating**  
**Number of Contacts**  
**Contact Size**

**A**  
**42 10 4**  
**16 8 0**



**48-60**

**A**  
**42 10 4**  
**16 8 0 (Coax) RG-214/U**



**CONTACT LEGEND**    16    12    8    4    0

# Thermocouple contact availability

A complete line of cylindrical connectors containing thermocouple insert arrangements is available. The contact layout for a particular arrangement will be found in either the MS/Standard contact arrangement section, pages 26-37, or the Special contact arrangement section, pages 38-48. All thermocouple contact layouts may contain either iron, alumel, chromel, constantan, standard (copper) or brass (dummy) contacts. See the thermocouple tabulations on the following pages.

The following abbreviations are used in the contact material column in the charts that follow. Also, thermocouple contacts are color coded as shown. (This identification is made by means of small dots of stain on the solder well end of the contact).

| Abbreviation | Material     | Color Code |
|--------------|--------------|------------|
| Ir.          | Iron         | Black      |
| Con.         | Constantan   | Yellow     |
| Cu.          | Copper Alloy | N/A        |
| Ch.          | Chromel      | White      |
| Al.          | Alumel       | Green      |
| Dummy        | Brass        | N/A        |

## WIRE WELL DATA

| Contact Size | Well Inside Dia.<br>+.004<br>-.002 | Well Depth<br>+.031<br>-.000 | Solder Well Barrel<br>Outside Dia. |
|--------------|------------------------------------|------------------------------|------------------------------------|
| 12           | .125                               | .250                         | .166 ±.003                         |
| 16           | .094                               | .188                         | .125 <sup>+.002</sup><br>-.004     |

## RECOMMENDED WIRE

|                      |  |
|----------------------|--|
| I Chromel - Alumel   | Use wire in accordance with MIL-W-5848 |
| II Iron - Constantan | Use wire in accordance with MIL-W-5845 |

# Thermocouple contact arrangements

| Shell Size and Arrg. | Similar to MS Arrg. | Total Contacts | Contact Size |    | Pin Insert Rotation C W | Contact Material                                |
|----------------------|---------------------|----------------|--------------|----|-------------------------|---|
|                      |                     |                | 12           | 16 |                         |   |
| 10SL-51              | 10SL-4              | 2              |              | 2  | 45°                     | A = Ir.; B = Con.                               |
| 10SL-52              | 10SL-4              | 2              |              | 2  | 45°                     | A = Cu.; B = Con.                               |
| 10SL-53              | 10SL-4              | 2              |              | 2  | 45°                     | A = Al.; B = Ch.                                |
| 10SL-54              | 10SL-3              | 3              |              | 3  | None                    | A = Ir.; B = Con.; C = Cu.                      |
| 10SL-55              | 10SL-3              | 3              |              | 3  | None                    | A = Al.; B = Ch.; C = Cu.                       |
| 10SL-56              | 10SL-4              | 2              |              | 2  | None                    | A = Al.; B = Ch.                                |
| 10SL-57              | 10SL-4              | 2              |              | 2  | None                    | A = Ch.; B = Con.                               |
| 10SL-58              | 10SL-3              | 3              |              | 3  | None                    | A = Ch.; B = Al.; C = Cu.                       |
| 10SL-59              | 10SL-4              | 2              |              | 2  | None                    | A = Ch.; B = Al.                                |
| 10SL-60              | 10SL-4              | 2              |              | 2  | None                    | A = Ir.; B = Con.                               |
| 10SL-61              | 10SL-4              | 2              |              | 2  | None                    | A = Cu.; B = Con.                               |
| 10SL-62              | 10SL-3              | 3              |              | 3  | None                    | A = Cu.; B = Al.; C = Ir.                       |
| 10SL-63              | 10SL-3              | 3              |              | 3  | None                    | A, C = Con.; B = Ch.                            |
| 10SL-64              | 10SL-3              | 3              |              | 3  | None                    | A, C = Ch.; B = Al.                             |
|                      |                     |                |              |    |                         |   |
| 12S-51               | 12S-3               | 2              |              | 2  | 315°                    | A = Ch.; B = Al.                                |
| 12S-54               | 12S-3               | 2              |              | 2  | 315°                    | A = Ir.; B = Con.                               |
| 12S-55               | 12S-3               | 2              |              | 2  | 45°                     | A = Cu.; B = Con.                               |
| 12S-56               | 12S-3               | 2              |              | 2  | None                    | A = Al.; B = Ch.                                |
| 12S-57               | 12S-3               | 2              |              | 2  | 60°                     | A = Ch.; B = Al.                                |
| 12S-58               | 12S-3               | 2              |              | 2  | 120°                    | A = Ir.; B = Con.                               |
| 12S-59               | 12S-3               | 2              |              | 2  | None                    | A = Ir.; B = Con.                               |
| 12S-60               | 12S-3               | 2              |              | 2  | None                    | A = Cu.; B = Con.                               |
| 12S-61               | 12S-3               | 2              |              | 2  | None                    | A = Ch.; B = Con.                               |
| 12S-62               | 12S-3               | 2              |              | 2  | None                    | A = Ch.; B = Al.                                |
|                      |                     |                |              |    |                         |   |
| 14S-51               | 14S-9               | 2              |              | 2  | 90°                     | A = Al.; B = Ch.                                |
| 14S-52               | 14S-2               | 4              |              | 4  | 45°                     | A, B = Cu.; C = Al.; D = Ch.                    |
| 14S-53               | 14S-9               | 2              |              | 2  | 90°                     | A = Ir.; B = Con.                               |
| 14S-54               | 14S-6               | 6              |              | 6  | 45°                     | A, C, E = Ir.; B, D, F = Con.                   |
| 14S-55               | 14S-2               | 4              |              | 4  | 45°                     | A, C = Ir.; B, D = Con.                         |
| 14S-56               | 14S-2               | 4              |              | 4  | 45°                     | A = Ir.; B = Con.; C, D = Cu.                   |
| 14S-57               | 14S-2               | 4              |              | 4  | 45°                     | A, C = Al.; B, D = Ch.                          |
| 14S-58               | 14S-7               | 3              |              | 3  | 45°                     | A = Al.; B = Ch.; C = Cu.                       |
| 14S-59               | 14S-9               | 2              |              | 2  | 90°                     | A = Cu.; B = Con.                               |
| 14S-60               | 14S-9               | 2              |              | 2  | None                    | A = Al.; B = Ch.                                |
| 14S-61               | 14S-6               | 6              |              | 6  | 45°                     | A = Al.; B = Ch.; C = Ir.; D = Con.; E, F = Cu. |
| 14S-63               | 14S-6               | 6              |              | 6  | None                    | A, C = Al.; B, D = Ch.; E = Ir.; F = Con.       |
| 14S-64               | 14S-2               | 4              |              | 4  | None                    | A, C = Con.; B, D = Cu.                         |
| 14S-65               | 14S-6               | 6              |              | 6  | None                    | A, C, E = Cu.; B, D, F = Con.                   |
| 14S-67               | 14S-6               | 6              |              | 6  | None                    | A = Al.; B = Ch.; Balance = Cu.                 |
| 14S-68               | 14S-2               | 4              |              | 4  | 45°                     | A = Ch.; B = Con.; C, D = Cu.                   |
| 14S-69               | 14S-7               | 3              |              | 3  | None                    | A = Con.; B = Ch.; C = Cu.                      |
| 14S-70               | 14S-2               | 4              |              | 4  | None                    | A, D = Ch.; B, C = Al.                          |
| 14S-71               | 14S-2               | 4              |              | 4  | None                    | A, B, D = Cu.; C = Con.                         |
| 14S-72               | 14S-9               | 2              |              | 2  | None                    | A = Con.; B = Cu.                               |
| 14S-73               | 14S-2               | 4              |              | 4  | None                    | A, B = Cu.; C = Al.; D = Ch.                    |

# Thermocouple contact arrangements

| Shell Size and Arrg. | Similar to MS Arrg. | Total Contacts | Contact Size |    | Pin Insert Rotation C W | Contact Material                                |
|----------------------|---------------------|----------------|--------------|----|-------------------------|---|
|                      |                     |                | 12           | 16 |                         |   |
| 14S-74               | 14S-2               | 4              |              | 4  | None                    | A, B = Ch.; C, D = Al.                          |
| 14S-75               | 14S-2               | 4              |              | 4  | None                    | A, B = Cu.; C, D = Con.                         |
| 14S-76               | 14S-2               | 4              |              | 4  | None                    | A, C = Al.; B, D = Ch.                          |
| 14S-77               | 14S-2               | 4              |              | 4  | None                    | A, D = Al.; B, C = Ch.                          |
| 14S-78               | 14S-9               | 2              |              | 2  | None                    | A = Ch.; B = Al.                                |
|                      |                     |                |              |    |                         |   |
| 16S-52               | 16S-4               | 2              |              | 2  | None                    | A = Ch.; B = Al.                                |
| 16S-54               | 16S-1               | 7              |              | 7  | None                    | A = Al.; B = Ch.; Balance = Cu.                 |
| 16S-55               | 16S-1               | 7              |              | 7  | None                    | A = Con.; Balance = Cu.                         |
|                      |                     |                |              |    |                         |   |
| 16-52                | 16-11               | 2              | 2            |    | 90°                     | A = Al.; B = Ch.                                |
| 16-53                | 16-9                | 4              | 2            | 2  | 70°                     | A = Al.; C = Ch.; B, D = Cu.                    |
| 16-55                | 16-10               | 3              | 3            |    | 45°                     | A = Al.; B = Ch.; C = Cu.                       |
| 16-56                | 16-13               | 2              | 2            |    | 90°                     | A = Con.; B = Cu.                               |
| 16-57                | 16-10               | 3              | 3            |    | None                    | A = Al.; B = Cu.; C = Ch.                       |
| 16-58                | 16-10               | 3              | 3            |    | None                    | A = Con.; B, C = Cu.                            |
| 16-60                | 16-13               | 2              | 2            |    | None                    | A = Al.; B = Ch.                                |
| 16-62                | 16-11               | 2              | 2            |    | None                    | A = Con.; B = Cu.                               |
|                      |                     |                |              |    |                         |   |
| 18-51                | 18-12               | 6              |              | 6  | None                    | A = Ir.; B, E = Con.; D = Cu.; C, F = Dummy     |
| 18-52                | 18-11               | 5              | 5            |    | None                    | A = Ir.; B = Con.; C = Ch.; D = Al.; E = Dummy  |
| 18-53                | 18-12               | 6              |              | 6  | None                    | A, D = Ir.; B, E = Con.; C, F = Dummy           |
| 18-54                | 18-15               | 4              | 4            |    | None                    | A, C = Al.; B, D = Ch.                          |
| 18-56                | 18-1                | 10             |              | 10 | 45°                     | A, C, E, G, I = Ir.; B, D, F, H, J = Con.       |
| 18-57                | 18-12               | 6              |              | 6  | 45°                     | A, C, E = Al.; B, D, F = Ch.                    |
| 18-59                | 18-12               | 6              |              | 6  | 45°                     | A, C = Ir.; B, E, F = Con.; D = Cu.             |
| 18-60                | 18-11               | 5              | 5            |    | 45°                     | A, D = Al.; B, C, = Ch.; E = Cu.                |
| 18-61                | 18-12               | 6              |              | 6  | None                    | A, C = Ir.; B, D = Con.; E = Ch.; F = Al.       |
| 18-62                | 18-12               | 6              |              | 6  | None                    | A, B, C = Ir.; D, E, F = Con.                   |
| 18-63                | 18-15               | 4              | 4            |    | None                    | A, C = Con.; B, D = Cu.                         |
| 18-65                | 18-12               | 6              |              | 6  | None                    | A = Ir.; B = Con.; Balance = Cu.                |
| 18-66                | 18-1                | 10             |              | 10 | None                    | A, C, E, G, I = Cu.; B, D, F, H, J = Con.       |
| 18-67                | 18-12               | 6              |              | 6  | None                    | A, C, E = Cu.; B, D, F = Con.                   |
| 18-68                | 18-11               | 5              | 5            |    | None                    | A, D = Al.; B, C = Ch.; E = Cu.                 |
| 18-69                | 18-1                | 10             |              | 10 | None                    | A = Al.; B = Ch.; Balance = Cu.                 |
| 18-70                | 18-11               | 5              | 5            |    | None                    | A = Ir.; B = Con.; C = Ch.; D = Al.; E = Cu.    |
| 18-71                | 18-15               | 4              | 4            |    | None                    | A = Con.; Balance = Cu.                         |
| 18-72                | 18-15               | 4              | 4            |    | None                    | D = Con.; Balance = Cu.                         |
| 18-73                | 18-9                | 7              | 2            | 5  | None                    | A = Al.; D = Ch.; Balance = Cu.                 |
| 18-74                | 18-12               | 6              |              | 6  | None                    | A = Ch.; B = Al.; D = Ir.; E = Cu.; C, F = Con. |
|                      |                     |                |              |    |                         |   |
| 20-52                | 20-4                | 4              | 4            |    | 315°                    | A = Ir.; B = Con.; C = Ch.; D = Al.             |
| 20-56                | 20-7                | 8              |              | 8  | 45°                     | A, B, G, H = Ir.; C, D, E, F = Con.             |
| 20-60                | 20-7                | 8              |              | 8  | 45°                     | D = Ch.; E = Al.; Balance = Cu.                 |
| 20-61                | 20-29               | 17             |              | 17 | 45°                     | A, B, M = Cu.; Balance = Con.                   |
| 20-62                | 20-15               | 7              | 7            |    | 80°                     | A, C, E = Al.; B, D, F = Ch.; G = Cu.           |
| 20-64                | 20-27               | 14             |              | 14 | None                    | A = Al.; C = Ch.; Balance = Cu.                 |

# Thermocouple contact arrangements

| Shell Size and Arrg. | Similar to MS Arrg. | Total Contacts | Contact Size |    | Pin Insert Rotation C W | Contact Material  |
|----------------------|---------------------|----------------|--------------|----|-------------------------|---|
|                      |                     |                | 12           | 16 |                         |   |
| 20-65                | 20-27               | 14             |              | 14 | None                    | A, B, C, D, E, F, G = Ir.; H, I, J, K, L, M, N = Con.   |
| 20-67                | 20-16               | 9              | 2            | 7  | None                    | H = Al.; I = Ch.; Balance = Cu.   |
| 20-68                | 20-7                | 8              |              | 8  | None                    | A, B, G, H = Con.; C, D, E, F = Cu.   |
| 20-69                | 20-27               | 14             |              | 14 | None                    | A, B, C, D, E, F, G = Cu.; H, I, J, K, L, M, N = Con.   |
| 20-70                | 20-29               | 17             |              | 17 | None                    | A, C, E, G, J, L, N, R, T = Ir.; B, D, F, H, K, M, P, S = Con.  |
| 20-71                | 20-29               | 17             |              | 17 | None                    | S = Al.; R = Ch.; Balance = Cu.   |
| 20-74                | 20-29               | 17             |              | 17 | None                    | A, C, E, G, J, L, N, R = Ir.; B, D, F, H, K, M, P, S = Con.; T = Cu.  |
| 20-75                | 20-15               | 7              | 7            |    | None                    | G = Al.; Balance = Ch.  |
| 20-77                | 20-16               | 9              | 2            | 7  | None                    | A = Con.; Balance = Std.  |
| 20-80                | 20-27               | 14             |              | 14 | None                    | A, C, E, G, I, K, M = Cu.; B, D, F, H, J, L, N = Con.   |
| 20-81                | 20-27               | 14             |              | 14 | None                    | A, C, E, G, I, K, M = Ch.; B, D, F, H, J, L, N = Al.  |
| 20-82                | 20-29               | 17             |              | 17 | None                    | A, C, E, G, J, L, N, R = Al.; B, D, F, H, K, M, P, S = Ch.; T = Cu.   |
|                      |                     |                |              |    |                         |   |
| 22-36                | 22-23               | 8              | 8            |    | 347°                    | A, C, E, G = Ir.; B, D, F, H = Con.   |
| 22-57                | 22-14               | 19             |              | 19 | 45°                     | A, C, E, G, J, L, N, R = Ir.; B, D, F, H, K, M, P, S = Con.; T, U, V = Cu.                                  |
| 22-60                | 22-14               | 19             |              | 19 | 45°                     | U = Al.; N = Ch.; Balance = Cu.   |
| 22-62                | 22-23               | 8              | 8            |    | 60°                     | A, B, F, G = Al.; C, D, E, H = Ch.  |
| 22-68                | 22-19               | 14             |              | 14 | 45°                     | A, C, E, G, J, L, M = Ir.; B, D, F, H, K, P, N = Con.   |
| 22-69                | 22-19               | 14             |              | 14 | 45°                     | A, C, E, G, J, L, M = Cu.; B, D, F, H, K, P, N = Con.   |
| 22-71                | 22-14               | 19             |              | 19 | None                    | V = Al.; U = Ch.; Balance = Cu.   |
| 22-72                | 22-5                | 6              | 2            | 4  | None                    | B = Al.; E = Ch.; Balance = Cu.   |
| 22-73                | 22-5                | 6              | 2            | 4  | None                    | E = Al.; B = Ch.; Balance = Cu.   |
| 22-74                | 22-23               | 8              | 8            |    | None                    | A, C, E, G = Ir.; B, D, F, H = Con.   |
| 22-75                | 22-23               | 8              | 8            |    | None                    | A = Al.; B, D, G, H = Cu.; C = Ch.; E = Ir.; F = Con.   |
| 22-76                |                     | 21             |              | 21 | None                    | W = Con.; Balance = Cu.   |
| 22-77                | 22-19               | 14             |              | 14 | None                    | B, D, F, H, J, K, M, P = Cu.; A, E, L = Ir.; C, G, N = Con.   |
| 22-78                | 22-14               | 19             |              | 19 | None                    | A, C, E, G, H, K, M, P, R, T = Con.; Balance = Cu.  |
| 22-79                | 22-10               | 4              |              | 4  | None                    | A, C, = Con.; B, D = Cu.  |
|                      |                     |                |              |    |                         |   |
| 24-56                | 24-20               | 11             | 2            | 9  | 45°                     | E = Al.; F = Ch.; Balance = Cu.   |
| 24-57                | 24-28               | 24             |              | 24 | 45°                     | A, C, J, V, Y, W, K, E, H, U, S, M = Ch.; Balance = Al.   |
| 24-62                | 24-28               | 24             |              | 24 | None                    | A, C, E, G = Ir.; B, D, F, H = Con.; R, T = Ch.; S, U = Al.; Balance = Cu.                                  |
| 24-63                | 24-28               | 24             |              | 24 | None                    | A, C, E, G, J, L, K, N, S, U, W, Y = Cu.; B, D, F, H, Q, R, M, P, T, V, X, Z = Con.                         |
| 24-64                | 24-5                | 16             |              | 16 | None                    | A, B, C, D, E, F, G, H = Ir.; J, K, L, M, N, P, R, S = Con.   |
| 24-68                | 24-28               | 24             |              | 24 | None                    | D = Con.; Balance = Cu.   |
| 24-81                | 24-7                | 16             | 2            | 14 | None                    | A, C, E, G, I, K, M, N, P = Cu.; B, D, F, H, J, L, O = Con.   |
|                      |                     |                |              |    |                         |   |
| 28-53                | 28-11               | 22             | 4            | 18 | 45°                     | J, L = Al.; K, M = Ch.; Balance = Cu.   |
| 28-58                | 28-20               | 14             | 10           | 4  | 45°                     | A, C, E, G, K, M = Al.; B, D, F, H, L, N = Ch.; J, P = Cu.  |
| 28-61                | 28-21               | 37             |              | 37 | 45°                     | A, C, J, Z, m, r, n, a, K, F, H, X, k, h, T, M, N, d = Ir.; Balance = Con.                                  |
| 28-63                | 28-20               | 14             | 10           | 4  | 45°                     | A, C, E, G, J = Al.; B, D, F, H, P = Ch.; Balance = Cu.   |
| 28-64                | 28-15               | 35             |              | 35 | None                    | A, d = Al.; B, j = Ch.; C, D, E, F, G, N, P, R, S, H, J, K, L, M, W, X, Y, Z = Con.; Balance = Cu.          |
| 28-65                | 28-12               | 26             |              | 26 | None                    | A, C, E, G, J, L, N, R, T, V = Ir.; X, Z = Al.; B, D, F, H, K, M, P, S, U, W = Con.; Y, a = Ch.; b, d = Cu. |
| 28-67                | 28-16               | 20             |              | 20 | None                    | U = Con.; Balance = Cu.   |
| 28-68                | 28-15               | 35             |              | 35 | 45°                     | T = Al.; U = Ch.; Balance = Cu.   |



# MS/Standard accessories

# MS/Standard Accessories

## MS3057-A style cable clamp, MS3420 sleeve

The MS3057-A style cable clamp was designed for use with jacketed cable or wires protected by tubing. Both clamping halves float for maximum strain relief. For unjacketed cable or wires, use corresponding MS3420 sleeve. To order clamp with sleeve, add -1 to the 97 - number. Two telescoping sleeves are furnished with shells sizes 24 and larger.



| Shell Size | Amphenol Number | A<br>±.031 | B<br>Max. | C<br>Dia.<br>Min. | V<br>Thread |
|------------|-----------------|------------|-----------|-------------------|-------------|
| 10SL, 12S  | 97-3057-1004    | .795       | .842      | .3125             | .6250-24    |
| 14, 14S    | 97-3057-1007    | .850       | .995      | .4375             | .7500-20    |
| 16, 16S    | 97-3057-1008    | .920       | 1.120     | .5625             | .8750-20    |
| 18         | 97-3057-1010    | .920       | 1.216     | .6250             | 1.0000-20   |
| 20, 22     | 97-3057-1012    | .927       | 1.403     | .7500             | 1.1875-18   |
| 24, 28     | 97-3057-1016    | 1.015      | 1.683     | .9375             | 1.4375-18   |
| 32         | 97-3057-1020    | 1.095      | 2.050     | 1.2500            | 1.7500-18   |
| 36         | 97-3057-1024    | 1.156      | 2.245     | 1.3750            | 2.0000-18   |

| Sleeve MS Part No. | Amphenol Number | A<br>±.005 | B<br>±.005 | C<br>±.010 | D<br>±.031 |
|--------------------|-----------------|------------|------------|------------|------------|
| 3420-3             | 9779-513-3      | .130       | .210       | .374       | 2.875      |
| 3420-4             | 9779-513-4      | .220       | .302       | .500       | 2.750      |
| 3420-6             | 9779-513-6      | .312       | .427       | .614       | 2.625      |
| 3420-8             | 9779-513-8      | .437       | .552       | .739       | 2.500      |
| 3420-10            | 9779-513-10     | .562       | .615       | .889       | 2.375      |
| 3420-12            | 9779-513-12     | .625       | .740       | 1.084      | 2.250      |
| 3420-16            | 9779-513-16     | .750       | .927       | 1.309      | 2.125      |
| 3420-20            | 9779-513-20     | .937       | 1.240      | 1.592      | 2.000      |
| 3420-24            | 9779-513-24     | 1.250      | 1.365      | 1.842      | 1.875      |





# MS/Standard Accessories

## 10-305200 cable clamp, MS3420( )A sleeve

Included in the design of the 10-305200 clamp are features such as a shorter overall length, greater reduction of close-down diameters by the use of accessory sleeves and waterproofing between the clamp and attaching shells. Finish is cadmium plating per QQ-P-146 type II, class 3 with olive drab chromate after-treatment. This is a suitable replacement clamp for M85049/1.



| Shell Size    | Clamp Part No. | A Thread Class 2B | B Dia. |        | E Dia. $\pm .016$ | F $\pm .010$ | G $+ .020$ $- .000$ | Sleeve MS Part No.               | H Dia.                |                      |
|---------------|----------------|-------------------|--------|--------|-------------------|--------------|---------------------|----------------------------------|-----------------------|----------------------|
|               |                |                   | Free   | Closed |                   |              |                     |                                  | Free $\pm .016$       | Closed               |
| 8S, 10S       | 10-305200-103  | .5000-28UNEF      | .219   | .027   | .719              | .797         | 1.010               | 3420-3A                          | .125                  | .000                 |
| 10SL, 12, 12S | 10-305200-123  | .6250-24NEF       | .312   | .094   | .844              | .891         | 1.010               | 3420-4A                          | .219                  | .010                 |
| 14, 14S       | 10-305200-143  | .7500-20UNEF      | .438   | .230   | .969              | 1.016        | 1.010               | 3420-6A<br>3420-4A               | .312<br>.219          | .114<br>.020         |
| 16, 16S       | 10-305200-163  | .8750-20UNEF      | .531   | .316   | 1.094             | 1.109        | 1.010               | 3420-8A<br>3420-6A               | .438<br>.312          | .222<br>.085         |
| 18            | 10-305200-183  | 1.0000-20UNEF     | .625   | .378   | 1.219             | 1.219        | 1.041               | 3420-10A<br>3420-6A              | .438<br>.312          | .200<br>.085         |
| 20, 22        | 10-305200-203  | 1.1875-18NEF      | .750   | .445   | 1.406             | 1.469        | 1.151               | 3420-12A<br>3420-8A              | .541<br>.438          | .270<br>.177         |
| 24, 28        | 10-305200-243  | 1.4375-18NEF      | .938   | .611   | 1.656             | 1.656        | 1.151               | 3420-16A<br>3420-12A<br>3420-8A  | .750<br>.541<br>.438  | .433<br>.260<br>.186 |
| 32            | 10-305200-323  | 1.7500-18NS       | 1.250  | .922   | 2.000             | 2.125        | 1.291               | 3420-20A<br>3420-16A<br>3420-12A | .938<br>.750<br>.541  | .620<br>.442<br>.273 |
| 36            | 10-305200-363  | 2.0000-18NS       | 1.375  | .922   | 2.250             | 2.250        | 1.510               | 3420-24A<br>3420-18A<br>3420-16A | 1.125<br>.938<br>.750 | .682<br>.504<br>.358 |
| 40            | 10-305200-403  | 2.2500-16UN       | 1.625  | 1.180  | 2.500             | 2.500        | 1.510               | 3420-28A<br>3420-20A<br>3420-16A | 1.250<br>.938<br>.750 | .816<br>.514<br>.368 |

# MS/Standard Accessories

## 10-350349 cable clamp, MS3420( )A sleeve

Cable clamp 10-350349 features a reduced close-down diameter, a positive, physical moisture barrier, and cadmium olive drab plating with a chromate after-treatment. It has a slightly longer overall length than the 10-305200. This is a suitable replacement clamp for M85049/2.



| Shell Size    | Clamp Part No. | A Thread Class 2A (Plated) | B Dia. |        | M Max. | Y Max. | Sleeve MS Part No.               | H Dia.                 |                       |
|---------------|----------------|----------------------------|--------|--------|--------|--------|----------------------------------|------------------------|-----------------------|
|               |                |                            | Free   | Closed |        |        |                                  | Free ±.016             | Closed                |
| 8S, 10S       | 10-350349-103  | .5000-28UNEF               | .219   | .027   | 1.313  | .812   | 3420-3A                          | .125                   | .000                  |
| 10SL, 12, 12S | 10-350349-123  | .6250-24UNEF               | .312   | .094   | 1.313  | .906   | 3420-4A                          | .219                   | .010                  |
| 14, 14S       | 10-350349-143  | .7500-20UNEF               | .438   | .230   | 1.313  | 1.031  | 3420-6A<br>3420-4A               | .312<br>.219           | .114<br>.020          |
| 16, 16S       | 10-350349-163  | .8750-20UNEF               | .531   | .316   | 1.313  | 1.125  | 3420-8A<br>3420-6A               | .438<br>.312           | .222<br>.085          |
| 18            | 10-350349-183  | 1.0000-20UNEF              | .625   | .378   | 1.391  | 1.234  | 3420-10A<br>3420-6A              | .438<br>.312           | .200<br>.085          |
| 20, 22        | 10-350349-203  | 1.1875-18UNEF              | .750   | .445   | 1.406  | 1.484  | 3420-12A<br>3420-8A              | .541<br>.438           | .270<br>.177          |
| 24, 28        | 10-350349-243  | 1.4375-18UNEF              | .938   | .611   | 1.516  | 1.671  | 3420-16A<br>3420-12A<br>3420-8A  | .750<br>.541<br>.438   | .433<br>.260<br>.186  |
| 32            | 10-350349-323  | 1.7500-18UNS               | 1.250  | .922   | 1.766  | 2.188  | 3420-20A<br>3420-16A<br>3420-12A | .938<br>.750<br>.541   | .620<br>.442<br>.273  |
| 36            | 10-350349-363  | 2.0000-18UNS               | 1.375  | .922   | 2.031  | 2.344  | 3420-24A<br>3420-18A<br>3420-16A | 1.125<br>.938<br>.750  | .682<br>.504<br>.358  |
| 40            | 10-350349-403  | 2.2500-16UN                | 1.625  | 1.180  | 2.031  | 2.594  | 3420-28A<br>3420-20A<br>3420-16A | 1.250<br>.938<br>.750  | .816<br>.514<br>.368  |
| 44            | 10-350349-443  | 2.5000-16UN                | 1.865  | 1.427  | 2.186  | 2.812  | 3420-32A<br>3420-28A<br>3420-20A | 1.625<br>1.250<br>.938 | 1.229<br>.897<br>.638 |

# MS/Standard Accessories

## 10-74900 series cable clamp

For waterproofing individual connectors, Amphenol offers a simple modification of the M85049/1 cable clamp. This assembly incorporates a rubber grommet with holes for individual wires in place of the gland. As the assembly is tightened, the grommet is compressed around each wire, sealing moisture

out. Based on standard MS insert arrangements, 97 different conductor combinations can be waterproofed. This assembly is identified as the 10-749XX (shell size) series and is used with the feed-thru shells on pages 59 and 60.

| Order Number | Total Thread Size | Total No. of Holes | No. & Size of Holes |                |               |               |               |  |
|--------------|-------------------|--------------------|---------------------|----------------|---------------|---------------|---------------|--|
|              |                   |                    | No. 16<br>.115      | No. 12<br>.150 | No. 8<br>.200 | No. 4<br>.310 | No. 0<br>.445 |  |
| 10-74910-2   | .5000-28UNEF-2B   | 1                  | 1                   |                |               |               |               |  |
| 10-74911-3   | .6250-24NEF-2B    | 3                  | 3                   |                |               |               |               |  |
| 10-74911-4   | .6250-24NEF-2B    | 2                  | 2                   |                |               |               |               |  |
| 10-74912-3   | .6250-24NEF-2B    | 2                  | 2                   |                |               |               |               |  |
| 10-74912-4   | .6250-24NEF-2B    | 1                  | 1                   |                |               |               |               |  |
| 10-74913-5   | .6250-24NEF-2B    | 1                  |                     | 1              |               |               |               |  |
| 10-74914-2   | .7500-20UNEF-2B   | 4                  | 4                   |                |               |               |               |  |
| 10-74914-4   | .7500-20UNEF-2B   | 1                  | 1                   |                |               |               |               |  |
| 10-74914-5   | .7500-20UNEF-2B   | 5                  | 5                   |                |               |               |               |  |
| 10-74914-6   | .7500-20UNEF-2B   | 6                  | 6                   |                |               |               |               |  |
| 10-74914-7   | .7500-20UNEF-2B   | 3                  | 3                   |                |               |               |               |  |
| 10-74914-9   | .7500-20UNEF-2B   | 2                  | 2                   |                |               |               |               |  |
| 10-74915-3   | .7500-20UNEF-2B   | 1                  |                     |                | 1             |               |               |  |
| 10-74916-1   | .8750-20UNEF-2A   | 7                  | 7                   |                |               |               |               |  |
| 10-74916-4   | .8750-20UNEF-2A   | 2                  | 2                   |                |               |               |               |  |
| 10-74916-5   | .8750-20UNEF-2A   | 3                  | 3                   |                |               |               |               |  |
| 10-74916-8   | .8750-20UNEF-2A   | 5                  | 5                   |                |               |               |               |  |
| 10-74917-7   | .8750-20UNEF-2A   | 3                  | 2                   |                | 1             |               |               |  |
| 10-74917-9   | .8750-20UNEF-2A   | 4                  | 2                   | 2              |               |               |               |  |
| 10-74917-10  | .8750-20UNEF-2A   | 3                  |                     | 3              |               |               |               |  |
| 10-74917-11  | .8750-20UNEF-2A   | 2                  |                     | 2              |               |               |               |  |
| 10-74917-12  | .8750-20UNEF-2A   | 1                  |                     |                |               | 1             |               |  |
| 10-74918-1   | 1.0000-20UNEF-2B  | 10                 | 10                  |                |               |               |               |  |
| 10-74918-5   | 1.0000-20UNEF-2B  | 3                  | 1                   | 2              |               |               |               |  |
| 10-74918-8   | 1.0000-20UNEF-2B  | 8                  | 7                   | 1              |               |               |               |  |
| 10-74918-9   | 1.0000-20UNEF-2B  | 7                  | 5                   | 2              |               |               |               |  |
| 10-74918-10  | 1.0000-20UNEF-2B  | 4                  |                     | 4              |               |               |               |  |
| 10-74918-11  | 1.0000-20UNEF-2B  | 5                  |                     | 5              |               |               |               |  |
| 10-74918-12  | 1.0000-20UNEF-2B  | 6                  | 6                   |                |               |               |               |  |
| 10-74918-15  | 1.0000-20UNEF-2B  | 4                  |                     | 4              |               |               |               |  |
| 10-74918-22  | 1.0000-20UNEF-2B  | 3                  | 3                   |                |               |               |               |  |
| 10-74920-6   | 1.1875-18NEF-2B   | 3                  | 3                   |                |               |               |               |  |
| 10-74920-7   | 1.1875-18NEF-2B   | 8                  | 8                   |                |               |               |               |  |
| 10-74920-8   | 1.1875-18NEF-2B   | 6                  | 4                   |                | 2             |               |               |  |
| 10-74920-9   | 1.1875-18NEF-2B   | 8                  | 7                   | 1              |               |               |               |  |
| 10-74920-15  | 1.1875-18NEF-2B   | 7                  |                     | 7              |               |               |               |  |
| 10-74920-18  | 1.1875-18NEF-2B   | 9                  | 6                   | 3              |               |               |               |  |
| 10-74920-19  | 1.1875-18NEF-2B   | 3                  |                     |                | 3             |               |               |  |
| 10-74920-20  | 1.1875-18NEF-2B   | 4                  |                     | 3              |               | 1             |               |  |
| 10-74920-21  | 1.1875-18NEF-2B   | 9                  | 8                   | 1              |               |               |               |  |
| 10-74920-22  | 1.1875-18NEF-2B   | 6                  | 3                   |                | 3             |               |               |  |
| 10-74920-23  | 1.1875-18NEF-2B   | 4                  | 2                   |                | 2             |               |               |  |
| 10-74920-24  | 1.1875-18NEF-2B   | 4                  | 2                   |                | 2             |               |               |  |
| 10-74920-27  | 1.1875-18NEF-2B   | 14                 | 14                  |                |               |               |               |  |
| 10-74920-29  | 1.1875-18NEF-2B   | 17                 | 17                  |                |               |               |               |  |
| 10-74922-4   | 1.8750-18NEF-2B   | 4                  |                     | 2              | 2             |               |               |  |
| 10-74922-5   | 1.8750-18NEF-2B   | 6                  | 4                   | 2              |               |               |               |  |
| 10-74922-7   | 1.8750-18NEF-2B   | 1                  |                     |                |               |               | 1             |  |
| 10-74922-13  | 1.8750-18NEF-2B   | 5                  | 1                   | 4              |               |               |               |  |
| 10-74922-14  | 1.8750-18NEF-2B   | 19                 | 19                  |                |               |               |               |  |

| Order Number | Total Thread Size | Total No. of Holes | No. & Size of Holes |                |               |               |               |   |
|--------------|-------------------|--------------------|---------------------|----------------|---------------|---------------|---------------|---|
|              |                   |                    | No. 16<br>.115      | No. 12<br>.150 | No. 8<br>.200 | No. 4<br>.310 | No. 0<br>.445 |   |
| 10-74922-16  | 1.8750-18NEF-2B   | 9                  | 6                   | 3              |               |               |               |   |
| 10-74922-20  | 1.8750-18NEF-2B   | 9                  | 9                   |                |               |               |               |   |
| 10-74922-21  | 1.8750-18NEF-2B   | 3                  | 2                   |                |               |               |               | 1 |
| 10-74922-22  | 1.8750-18NEF-2B   | 4                  |                     |                |               | 4             |               |   |
| 10-74922-23  | 1.8750-18NEF-2B   | 8                  |                     | 8              |               |               |               |   |
| 10-74924-2   | 1.4375-18NEF-2B   | 7                  |                     | 7              |               |               |               |   |
| 10-74924-5   | 1.4375-18NEF-2B   | 16                 | 16                  |                |               |               |               |   |
| 10-74924-6   | 1.4375-18NEF-2B   | 8                  |                     | 8              |               |               |               |   |
| 10-74924-7   | 1.4375-18NEF-2B   | 16                 | 14                  | 2              |               |               |               |   |
| 10-74924-9   | 1.4375-18NEF-2B   | 2                  |                     |                |               |               | 2             |   |
| 10-74924-10  | 1.4375-18NEF-2B   | 7                  |                     |                |               | 7             |               |   |
| 10-74924-11  | 1.4375-18NEF-2B   | 9                  |                     | 6              | 3             |               |               |   |
| 10-74924-12  | 1.4375-18NEF-2B   | 5                  |                     | 3              |               |               | 2             |   |
| 10-74924-17  | 1.4375-18NEF-2B   | 5                  | 3                   | 2              |               |               |               |   |
| 10-74924-20  | 1.4375-18NEF-2B   | 11                 | 9                   | 2              |               |               |               |   |
| 10-74924-22  | 1.4375-18NEF-2B   | 4                  |                     |                |               | 4             |               |   |
| 10-74928-2   | 1.4375-18NEF-2B   | 14                 | 12                  | 2              |               |               |               |   |
| 10-74928-6   | 1.4375-18NEF-2B   | 3                  |                     |                |               |               | 3             |   |
| 10-74928-9   | 1.4375-18NEF-2B   | 12                 | 6                   | 6              |               |               |               |   |
| 10-74928-10  | 1.4375-18NEF-2B   | 7                  |                     | 3              | 2             | 2             |               |   |
| 10-74928-11  | 1.4375-18NEF-2B   | 22                 | 18                  | 4              |               |               |               |   |
| 10-74928-12  | 1.4375-18NEF-2B   | 26                 | 26                  |                |               |               |               |   |
| 10-74928-15  | 1.4375-18NEF-2B   | 35                 | 35                  |                |               |               |               |   |
| 10-74928-16  | 1.4375-18NEF-2B   | 20                 | 20                  |                |               |               |               |   |
| 10-74928-17  | 1.4375-18NEF-2B   | 15                 | 15                  |                |               |               |               |   |
| 10-74928-18  | 1.4375-18NEF-2B   | 12                 | 12                  |                |               |               |               |   |
| 10-74928-19  | 1.4375-18NEF-2B   | 10                 | 6                   | 4              |               |               |               |   |
| 10-74928-21  | 1.4375-18NEF-2B   | 37                 | 37                  |                |               |               |               |   |
| 10-74928-22  | 1.4375-18NEF-2B   | 6                  | 3                   |                |               |               | 3             |   |
| 10-74928-51* | 1.4375-18NEF-2B   | 12                 |                     | 12             |               |               |               |   |
| 10-74932-2   | 1.7500-18NS-2B    | 5                  | 2                   |                |               |               | 3             |   |
| 10-74932-5   | 1.7500-18NS-2B    | 2                  |                     |                |               |               |               | 2 |
| 10-74932-6   | 1.7500-18NS-2B    | 23                 | 16                  | 2              | 3             | 2             |               |   |
| 10-74932-7   | 1.7500-18NS-2B    | 35                 | 28                  | 7              |               |               |               |   |
| 10-74932-8   | 1.7500-18NS-2B    | 30                 | 24                  | 6              |               |               |               |   |
| 10-74932-9   | 1.7500-18NS-2B    | 14                 | 12                  |                |               |               | 2             |   |
| 10-74932-13  | 1.7500-18NS-2B    | 23                 | 18                  | 5              |               |               |               |   |
| 10-74932-15  | 1.7500-18NS-2B    | 8                  |                     | 6              |               |               |               | 2 |
| 10-74932-17  | 1.7500-18NS-2B    | 4                  |                     |                |               |               | 4             |   |
| 10-74936-1   | 2.0000-18NS-2B    | 22                 | 18                  | 4              |               |               |               |   |
| 10-74936-4   | 2.0000-18NS-2B    | 3                  |                     |                |               |               |               | 3 |
| 10-74936-5   | 2.0000-18NS-2B    | 4                  |                     |                |               |               |               | 4 |
| 10-74936-6   | 2.0000-18NS-2B    | 6                  |                     |                |               |               | 4             | 2 |
| 10-74936-7   | 2.0000-18NS-2B    | 47                 | 40                  | 7              |               |               |               |   |
| 10-74936-8   | 2.0000-18NS-2B    | 47                 | 46                  | 1              |               |               |               |   |
| 10-74936-10  | 2.0000-18NS-2B    | 48                 | 48                  |                |               |               |               |   |
| 10-74936-14  | 2.0000-18NS-2B    | 16                 | 6                   | 5              | 5             |               |               |   |
| 10-74936-52* | 2.0000-18NS-2B    | 52                 | 52                  |                |               |               |               |   |
| 10-74940-9   | 2.2500-16UN-2B    | 47                 | 24                  | 22             | 1             |               |               |   |
| 10-74940-56* | 2.2500-16UN-2B    | 85                 | 85                  |                |               |               |               |   |

NOTE: The 74900 series is available with a cadmium plate clear chromate after-treatment, designated by 10-74900. 71-74900 is the base number to use if a cadmium plate olive drab chromate after-treatment is required.

\* Proprietary insert arrangements.

# MS/Standard Accessories thru-bulkhead shells

## 10-113276-XXX\*

### For Open Wire Waterproofing

Similar to the 10-37090 shell in construction, but substitutes jam nut mounting. The 10-74900 grommet seats against the undercut for moisture-proofing between the clamp assembly and the shell.



| Shell Size | Order Number  | A Thread         | B<br>+.010<br>-.000 | C<br>±.005 | D<br>±.010 | E<br>±.010 | F<br>±.010 |
|------------|---------------|------------------|---------------------|------------|------------|------------|------------|
| 10         | 10-113276-10X | .5000-28UNEF-2A  | .203                | 1.000      | .875       | 1.031      | .309       |
| 12         | 10-113276-12X | .6250-24NEF-2A   | .328                | 1.000      | 1.000      | 1.156      | .354       |
| 14         | 10-113276-14X | .7500-20UNEF-2A  | .453                | 1.000      | 1.125      | 1.312      | .397       |
| 16         | 10-113276-16X | .8750-20UNEF-2A  | .578                | 1.062      | 1.250      | 1.438      | .442       |
| 18         | 10-113276-18X | 1.0000-20UNEF-2A | .676                | 1.062      | 1.375      | 1.562      | .486       |
| 20         | 10-113276-20X | 1.1875-18NEF-2A  | .801                | 1.062      | 1.688      | 1.875      | .596       |
| 22         | 10-113276-22X | 1.1875-18NEF-2A  | .906                | 1.062      | 1.688      | 1.875      | .596       |
| 24         | 10-113276-24X | 1.4375-18NEF-2A  | 1.016               | 1.062      | 1.938      | 2.188      | .685       |
| 28         | 10-113276-28X | 1.4375-18NEF-2A  | 1.130               | 1.062      | 1.938      | 2.188      | .685       |
| 32         | 10-113276-32X | 1.7500-18NS-2A   | 1.438               | 1.062      | 2.250      | 2.625      | .795       |
| 36         | 10-113276-36X | 2.0000-18NS-2A   | 1.678               | 1.281      | 2.500      | 2.875      | .884       |
| 40         | 10-113276-40X | 2.2500-16UN-2A   | 1.914               | 1.344      | 2.750      | 3.125      | .972       |

## 10-37090-XXX\*

### For Open Wire Waterproofing

A feed-thru shell with an undercut for retention of the grommet in the 10-74900 series clamp. The undercut is notched to prevent grommet slippage. Mounts to panel with four mounting bolts.



| Shell Size | Order Number | A Thread         | B<br>+.010<br>-.000 | C<br>±.010 | D<br>±.010 | E<br>±.005 | F<br>+.004<br>-.002 |
|------------|--------------|------------------|---------------------|------------|------------|------------|---------------------|
| 10         | 10-37090-10X | .5000-28UNEF-2A  | .203                | .820       | .875       | .594       | .120                |
| 12         | 10-37090-12X | .6250-24NEF-2A   | .328                | .820       | 1.000      | .719       | .120                |
| 14         | 10-37090-14X | .7500-20UNEF-2A  | .453                | .820       | 1.094      | .812       | .120                |
| 16         | 10-37090-16X | .8750-20UNEF-2A  | .578                | .820       | 1.188      | .906       | .120                |
| 18         | 10-37090-18X | 1.0000-20UNEF-2A | .676                | .820       | 1.281      | .969       | .120                |
| 20         | 10-37090-20X | 1.1875-18NEF-2A  | .801                | .850       | 1.438      | 1.125      | .120                |
| 22         | 10-37090-22X | 1.1875-18NEF-2A  | .906                | .850       | 1.438      | 1.125      | .120                |
| 24         | 10-37090-24X | 1.4375-18NEF-2A  | 1.016               | .875       | 1.688      | 1.312      | .147                |
| 28         | 10-37090-28X | 1.4375-18NEF-2A  | 1.130               | .875       | 1.688      | 1.312      | .147                |
| 32         | 10-37090-32X | 1.7500-18NS-2A   | 1.438               | .875       | 2.000      | 1.562      | .147                |
| 36         | 10-37090-36X | 2.0000-18NS-2A   | 1.678               | 1.133      | 2.250      | 1.750      | .173                |
| 40         | 10-37090-40X | 2.2500-16UN-2A   | 1.914               | 1.133      | 2.500      | 1.938      | .173                |

\* To complete order number add shell size and suffix number from finish chart below. For example, shell size 12 with an olive drab chromate finish would be 10-113276-123 or 10-37090-123.

| Finish              | 10-No. Suffix |
|---------------------|---------------|
| Chromate treat      | -XX1          |
| Olive drab chromate | -XX3          |

# MS/Standard Accessories thru-bulkhead shells

## 10-113275-XXX\*

### For Multi-Conductor Cable

One panel hole will provide mounting surface for this shell. Tightening the mounting nut locks the assembly in place and allows room for attachment of the 10-305200 clamp.



| Shell Size | Order Number  | A Thread         | B ±.010 | C ±.005 | D ±.010 | E ±.010 | F ±.010 |
|------------|---------------|------------------|---------|---------|---------|---------|---------|
| 10         | 10-113275-10X | .5000-28UNEF-2A  | .276    | .891    | .875    | 1.031   | .309    |
| 12         | 10-113275-12X | .6250-24NEF-2A   | .396    | .891    | 1.000   | 1.156   | .354    |
| 14         | 10-113275-14X | .7500-20UNEF-2A  | .512    | .891    | 1.125   | 1.312   | .397    |
| 16         | 10-113275-16X | .8750-20UNEF-2A  | .636    | .959    | 1.250   | 1.438   | .442    |
| 18         | 10-113275-18X | 1.0000-20UNEF-2A | .762    | .969    | 1.375   | 1.562   | .486    |
| 20-22      | 10-113275-20X | 1.1875-18NEF-2A  | .918    | .969    | 1.688   | 1.875   | .596    |
| 24-28      | 10-113275-24X | 1.4375-18NEF-2A  | 1.167   | .969    | 1.938   | 2.188   | .685    |
| 32         | 10-113275-32X | 1.7500-18NS-2A   | 1.480   | 1.016   | 2.250   | 2.625   | .795    |
| 36         | 10-113275-36X | 2.0000-18NS-2A   | 1.730   | 1.078   | 2.500   | 2.875   | .884    |
| 40         | 10-113275-40X | 2.2500-16UN-2A   | 1.972   | 1.141   | 2.750   | 3.125   | .972    |

## 10-37093-XXX\*

### For Multi-Conductor Cable

Designed to accommodate cable entrance through panel wall or bulkhead and provide attachment for 10-305200 cable clamp. Mounts to panel or wall with four mounting bolts.



| Shell Size | Order Number | A Thread         | B ±.010 | C ±.010 | D ±.010 | E ±.005 | F +.004<br>-.002 |
|------------|--------------|------------------|---------|---------|---------|---------|------------------|
| 10         | 10-37093-10X | .5000-28UNEF-2A  | .276    | .710    | .875    | .594    | .120             |
| 12         | 10-37093-12X | .6250-24NEF-2A   | .396    | .710    | 1.000   | .719    | .120             |
| 14         | 10-37093-14X | .7500-20UNEF-2A  | .512    | .710    | 1.094   | .812    | .120             |
| 16         | 10-37093-16X | .8750-20UNEF-2A  | .636    | .710    | 1.188   | .906    | .120             |
| 18         | 10-37093-18X | 1.0000-20UNEF-2A | .762    | .710    | 1.281   | .969    | .120             |
| 20-22      | 10-37093-20X | 1.1875-18NEF-2A  | .918    | .741    | 1.438   | 1.125   | .120             |
| 24-28      | 10-37093-24X | 1.4375-18NEF-2A  | 1.167   | .766    | 1.688   | 1.312   | .147             |
| 32         | 10-37093-32X | 1.7500-18NS-2A   | 1.480   | .856    | 2.000   | 1.562   | .147             |
| 36         | 10-37093-36X | 2.0000-18NS-2A   | 1.730   | .931    | 2.250   | 1.750   | .173             |
| 40         | 10-37093-40X | 2.2500-16UN-2A   | 1.972   | .931    | 2.500   | 1.938   | .173             |

\* To complete order number add shell size and suffix number from finish chart below. For example, shell size 12 with an olive drab chromate finish would be 10-113275-123 or 10-37093-123.

| Finish              | 10-No. Suffix |
|---------------------|---------------|
| Chromate treat      | -XX1          |
| Olive drab chromate | -XX3          |

# Assembly Instructions for 10-305200 & 10-74900 cable clamps

The 10-305200 cable clamp and MS3420A sleeve illustrated are used only on the rear of MS-A or C type connectors. The 10-74900 clamp and grommet assembly can only be used on special feed-thru applications involving dummy shells, part numbers 10-37090 and 10-113276.



## ASSEMBLY

Both clamps are shipped from the factory with lubricant conforming to MIL-G-3278. Remove any dirt or foreign material from components with ethyl alcohol and relubricate as outlined under "lubrication." Place the clamping nut (1) on the wire bundle or cable with the threads facing toward the connector or dummy shell. Position the tapered sleeve (2) on the bundle or cable with the narrow portion toward the clamping nut (1). Next install either the gland (3) used with the 10-305200 clamp or thread each wire through the grommet (3) used with the 10-74900 clamp. Dependent on the application, the wire bundle or cable is fed through the dummy shell, or the wire ends are soldered to the connector contacts. Move the components forward in the reverse order of preliminary assembly. (In applications where grommets (3) are used, seat the grommet against the undercut in the back shell before bringing the tapered sleeve (2) up against it). Insure proper positioning of glands (3) or grommets (3), tapered sleeves (2) and clamping nuts (1). Tighten the clamp using a strap wrench until a metal to metal seat is obtained.

# MS/Standard Accessories

## grommet/sealing plugs

### GROMMET 10-408XX-XX\*

The Amphenol® grommet provides maximum performance when cables are used which have an O.D. equal to the O.D. specified in MIL-W-5086. For waterproof assembly a cable sheath of neoprene base material is required maintaining the O.D. per MIL-W-5086.



| MS Shell Size | Order Number* | A<br>±.010 | B<br>±.010 | C<br>+.010<br>-.020 |
|---------------|---------------|------------|------------|---------------------|
| 8S            | 10-40808-XX   | .312       | .250       | .406                |
| 10S           | 10-40810-XX   | .312       | .250       | .406                |
| 10SL          | 10-40811-XX   | .312       | .375       | .406                |
| 12S           | 10-40812-XX   | .312       | .375       | .406                |
| 12            | 10-40813-XX   | .375       | .375       | .469                |
| 14S           | 10-40814-XX   | .312       | .500       | .406                |
| 14            | 10-40815-XX   | .375       | .500       | .469                |
| 16S           | 10-40816-XX   | .312       | .625       | .406                |
| 16            | 10-40817-XX   | .375       | .625       | .469                |
| 18            | 10-40818-XX   | .438       | .750       | .532                |
| 20            | 10-40820-XX   | .438       | .875       | .532                |
| 22            | 10-40822-XX   | .438       | 1.000      | .532                |
| 24            | 10-40824-XX   | .438       | 1.125      | .594                |
| 28            | 10-40828-XX   | .438       | 1.240      | .594                |
| 32            | 10-40832-XX   | .438       | 1.531      | .657                |
| 36            | 10-40836-XX   | .438       | 1.766      | .657                |
| 40            | 10-40840-XX   | .438       | 2.000      | .657                |

\* To complete grommet order number add the contact arrangement number desired. (See pages 22 and 23 for available insert arrangements). Example: 10-40810-2 is the order number for the grommet used with 10S-2 insert arrangement.

### SEALING PLUG MS27488-XX-1 10-405996-XX1

Sealing plugs are used to fill unused holes in multi-holed grommet configurations.

| Order No.     | Contact Size | MS Number  | Wire Size | Color Code | A Dia.<br>±.010 | B<br>±.005 | C<br>±.010 |
|---------------|--------------|------------|-----------|------------|-----------------|------------|------------|
| 10-405996-161 | 16           | 27488-16-1 | 20-16     | Blue       | .083            | .133       | .564**     |
| 10-405996-121 | 12           | 27488-12-1 | 14-12     | Yellow     | .121            | .171       | .564**     |
| 10-405996-81  | 8            | 27488-8-1  | 10-8      | White      | .185            | .315       | .470       |
| 10-405996-41  | 4            | 27488-4-1  | 4-6       | Blue       | .310            | .415       | .470       |
| 10-405996-01  | 0            | 27488-0-1  | 0-2       | Yellow     | .440            | .605       | 1.000      |

\*\*±.020

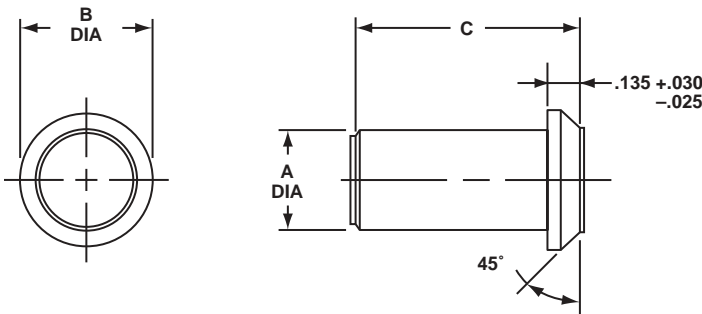

# MS/Standard Accessories

## protection caps – plug

### PLUG PROTECTION CAP 10-329391-XX\*

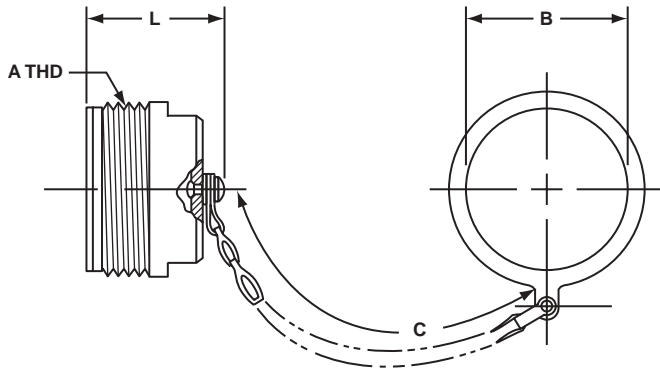

| Assembly Number | A Thread Class 2A | B Dia. +.010 - .000 | C Approx. | L Max. |
|-----------------|-------------------|---------------------|-----------|--------|
| 10-329391-10    | .625-24UNEF       | .516                | 3.5       | 1.312  |
| 10-329391-11    | .625-24UNEF       | .641                | 3.5       | 1.312  |
| 10-329391-12    | .750-20UNEF       | .641                | 3.5       | 1.500  |
| 10-329391-14    | .875-20UNEF       | .766                | 3.5       | 1.500  |
| 10-329391-16    | 1.000-20UNEF      | .891                | 3.5       | 1.500  |
| 10-329391-18    | 1.125-18UNEF      | 1.016               | 3.5       | 1.500  |
| 10-329391-20    | 1.250-18UNEF      | 1.141               | 4.0       | 1.500  |
| 10-329391-22    | 1.375-18UNEF      | 1.266               | 4.0       | 1.500  |
| 10-329391-24    | 1.500-18UNEF      | 1.391               | 4.5       | 1.500  |
| 10-329391-28    | 1.750-18UNS       | 1.641               | 4.5       | 1.500  |
| 10-329391-32    | 2.000-18UNS       | 1.891               | 5.0       | 1.500  |
| 10-329391-36    | 2.250-16UN        | 2.078               | 5.0       | 1.500  |
| 10-329391-40    | 2.500-16UN        | 2.328               | 5.0       | 1.500  |
| 10-329391-44    | 2.750-16UN        | 2.641               | 6.0       | 1.500  |

### PLUG PROTECTION CAP 10-229125-XX\*

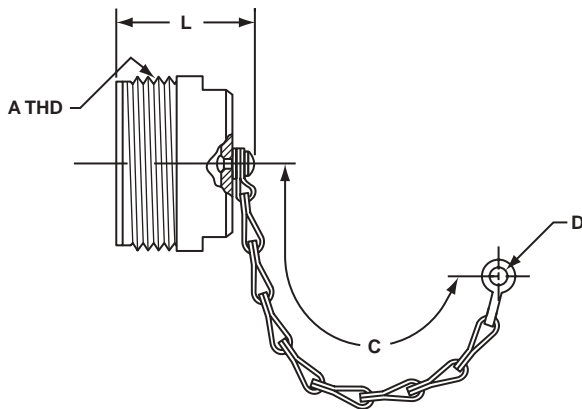

| Assembly Number | A Thread Class 2A | C Approx. | D Ref. | L Max. |
|-----------------|-------------------|-----------|--------|--------|
| 10-229125-10    | .625-24NEF        | 3.0       | .140   | 1.233  |
| 10-229125-12    | .750-20UNEF       | 3.5       | .140   | 1.421  |
| 10-229125-14    | .875-20UNEF       | 3.5       | .140   | 1.421  |
| 10-229125-16    | 1.000-20UNEF      | 3.5       | .140   | 1.421  |
| 10-229125-18    | 1.125-18NEF       | 3.5       | .140   | 1.421  |
| 10-229125-20    | 1.250-18NEF       | 3.5       | .193   | 1.421  |
| 10-229125-22    | 1.375-18NEF       | 3.5       | .193   | 1.421  |
| 10-229125-24    | 1.500-18NEF       | 4.5       | .193   | 1.421  |
| 10-229125-28    | 1.750-18NS        | 4.5       | .193   | 1.421  |
| 10-229125-32    | 2.000-18NS        | 5.0       | .193   | 1.421  |
| 10-229125-36    | 2.250-16UN        | 5.0       | .193   | 1.421  |
| 10-229125-40    | 2.500-16UN        | 5.0       | .193   | 1.421  |

### PLUG PROTECTION CAP MS25042-XXDA\*

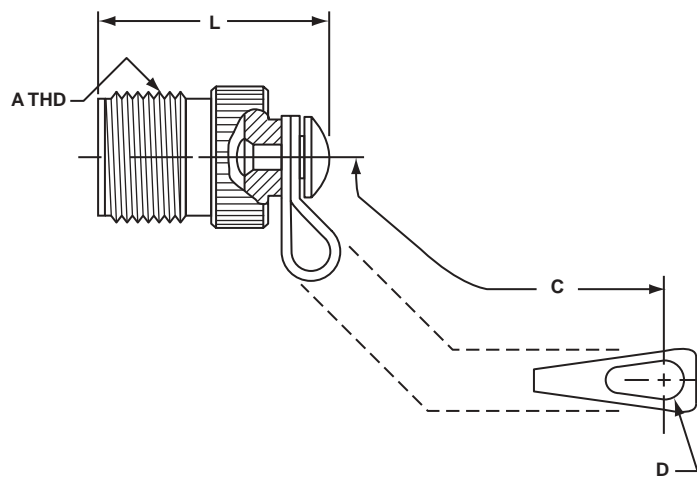

| MS Number    | A Thread Class 2A | B Dia. +.010 - .005 | C Approx. | L Max. |
|--------------|-------------------|---------------------|-----------|--------|
| MS25042-8DA  | .500-28UNEF       | .156                | 4.00      | .969   |
| MS25042-10DA | .625-24UNEF       | .156                | 4.00      | .969   |
| MS25042-12DA | .750-20UNEF       | .156                | 4.50      | 1.156  |
| MS25042-14DA | .875-20UNEF       | .156                | 4.50      | 1.156  |
| MS25042-16DA | 1.000-20UNEF      | .156                | 4.50      | 1.156  |
| MS25042-18DA | 1.125-18UNEF      | .156                | 4.50      | 1.156  |
| MS25042-20DA | 1.250-18UNEF      | .187                | 5.00      | 1.156  |
| MS25042-22DA | 1.375-18UNEF      | .187                | 5.00      | 1.156  |
| MS25042-24DA | 1.500-18UNEF      | .187                | 5.50      | 1.156  |
| MS25042-28DA | 1.750-18UNS       | .187                | 7.75      | 1.156  |
| MS25042-32DA | 2.000-18UNS       | .218                | 7.75      | 1.156  |
| MS25042-36DA | 2.250-16UN        | .218                | 7.75      | 1.156  |
| MS25042-40DA | 2.500-16UN        | .218                | 7.75      | 1.156  |

\* Protective caps are illustrated with sash chains and are available with beaded chains or without chains. Optional terminations are also available. Consult Amphenol, Sidney, NY when ordering.



# MS/Standard Accessories

## protection caps – receptacle

### RECEPTACLE PROTECTION CAP 10-329392-XX\*

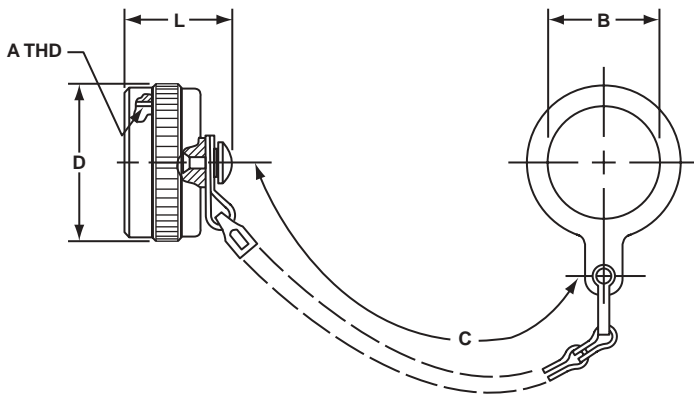

| Assembly Number | A Thread Class 2B | B Dia. Min. | C Approx. | D Dia. Max. | L Max. |
|-----------------|-------------------|-------------|-----------|-------------|--------|
| 10-329392-10    | .625-24UNEF       | .516        | 3.5       | .875        | .793   |
| 10-329392-12    | .750-20UNEF       | .641        | 3.5       | 1.000       | .793   |
| 10-329392-14    | .875-20UNEF       | .766        | 3.5       | 1.125       | .793   |
| 10-329392-16    | 1.000-20UNEF      | .891        | 3.5       | 1.250       | .793   |
| 10-329392-18    | 1.125-18UNEF      | 1.016       | 3.5       | 1.375       | 1.024  |
| 10-329392-20    | 1.250-18UNEF      | 1.141       | 4.0       | 1.500       | 1.024  |
| 10-329392-22    | 1.375-18UNEF      | 1.266       | 4.0       | 1.625       | 1.024  |
| 10-329392-24    | 1.500-18UNEF      | 1.391       | 4.5       | 1.750       | 1.024  |
| 10-329392-28    | 1.750-18UNS       | 1.641       | 4.5       | 2.000       | 1.024  |
| 10-329392-32    | 2.000-18UNS       | 1.891       | 5.0       | 2.250       | 1.024  |
| 10-329392-36    | 2.250-16UN        | 2.078       | 5.0       | 2.500       | 1.024  |
| 10-329392-40    | 2.500-16UN        | 2.328       | 5.0       | 2.656       | 1.024  |
| 10-329392-44    | 2.750-16UN        | 2.641       | 6.0       | 2.938       | 1.024  |

### RECEPTACLE PROTECTION CAP 10-422905-XXX\*



| Assembly Number | A Thread Class 2B | B Ref. | C Approx. | D Dia. Max. | L Max. |
|-----------------|-------------------|--------|-----------|-------------|--------|
| 10-422905-103   | .625-24UNEF       | .140   | 3.0       | .875        | .812   |
| 10-422905-123   | .750-20UNEF       | .140   | 3.5       | 1.000       | .812   |
| 10-422905-143   | .875-20UNEF       | .140   | 3.5       | 1.125       | .812   |
| 10-422905-163   | 1.000-20UNEF      | .140   | 3.5       | 1.250       | .812   |
| 10-422905-183   | 1.125-18UNEF      | .193   | 3.5       | 1.375       | 1.031  |
| 10-422905-203   | 1.250-18UNEF      | .193   | 4.0       | 1.500       | 1.031  |
| 10-422905-223   | 1.375-18UNEF      | .193   | 4.0       | 1.625       | 1.031  |
| 10-422905-243   | 1.500-18UNEF      | .193   | 4.5       | 1.750       | 1.031  |
| 10-422905-283   | 1.750-18UNS       | .193   | 4.5       | 2.000       | 1.031  |
| 10-422905-323   | 2.000-18UNS       | .193   | 5.0       | 2.250       | 1.031  |
| 10-422905-363   | 2.250-16UN        | .193   | 5.0       | 2.500       | 1.031  |
| 10-422905-403   | 2.500-16UN        | .193   | 5.0       | 2.656       | 1.031  |

### RECEPTACLE PROTECTION CAP MS25043-XXDA\*



| MS Number    | A Thread Class 2B | B +.010 - .005 | C Approx. | D Dia. Max. | L Max. |
|--------------|-------------------|----------------|-----------|-------------|--------|
| MS25043-8DA  | .500-28UNEF       | .140           | 4.00      | .688        | .750   |
| MS25043-10DA | .625-24UNEF       | .140           | 4.00      | .815        | .750   |
| MS25043-12DA | .750-20UNEF       | .140           | 4.50      | 1.000       | .750   |
| MS25043-14DA | .875-20UNEF       | .140           | 4.50      | 1.125       | .750   |
| MS25043-16DA | 1.000-20UNEF      | .140           | 4.50      | 1.188       | .750   |
| MS25043-18DA | 1.125-18UNEF      | .140           | 4.50      | 1.344       | .750   |
| MS25043-20DA | 1.250-18UNEF      | .140           | 5.00      | 1.469       | .750   |
| MS25043-22DA | 1.375-18UNEF      | .140           | 5.00      | 1.594       | .750   |
| MS25043-24DA | 1.500-18UNEF      | .171           | 5.50      | 1.719       | .750   |
| MS25043-28DA | 1.750-18UNS       | .171           | 7.75      | 1.969       | .812   |
| MS25043-32DA | 2.000-18UNS       | .187           | 7.75      | 2.219       | .812   |
| MS25043-36DA | 2.250-16UN        | .187           | 7.75      | 2.469       | .812   |
| MS25043-40DA | 2.500-16UN        | .187           | 7.75      | 2.719       | .812   |

\* Protective caps are illustrated with sash chains and are available with beaded chains or without chains. Optional terminations are also available. Consult Amphenol, Sidney, NY when ordering.

# MS/Standard Accessories

## dust caps

### 10-70500 RECEPTACLE DUST CAP

for external threads



| MS Shell Size | Order Number | A Dia. Nominal Thread | C Dia. $\pm.031$ | L <sup>1</sup> $\pm.062$ |
|---------------|--------------|-----------------------|------------------|--------------------------|
| 8S            | 10-70500-8   | .500                  | .750             | .500                     |
| 10S           | 10-70500-10  | .625                  | .875             | .500                     |
| 10SL          | 10-70500-10  | .625                  | .875             | .500                     |
| 12S           | 10-70500-12  | .750                  | 1.000            | .500                     |
| 12            | 10-70500-12  | .750                  | 1.000            | .500                     |
| 14S           | 10-70500-14  | .875                  | 1.125            | .500                     |
| 14            | 10-70500-14  | .875                  | 1.125            | .500                     |
| 16S           | 10-70500-16  | 1.000                 | 1.250            | .500                     |
| 16            | 10-70500-16  | 1.000                 | 1.250            | .500                     |
| 18            | 10-70500-18  | 1.125                 | 1.375            | .562                     |
| 20            | 10-70500-20  | 1.250                 | 1.500            | .562                     |
| 22            | 10-70500-22  | 1.375                 | 1.625            | .562                     |
| 24            | 10-70500-24  | 1.500                 | 1.750            | .562                     |
| 28            | 10-70500-28  | 1.750                 | 1.938            | .562                     |
| 32            | 10-70500-32  | 2.000                 | 2.250            | .562                     |
| 36            | 10-70500-36  | 2.250                 | 2.500            | .625                     |
| 40            | 10-70500-40  | 2.500                 | 2.750            | .625                     |

### 10-70506 PLUG DUST CAP

for internal threads



| MS Shell Size | Order Number | B Dia. Min. | L <sup>2</sup> $\pm.125$ |
|---------------|--------------|-------------|--------------------------|
| 8S            | 10-70506-8S  | .469        | .625                     |
| 10S           | 10-70506-10S | .587        | .625                     |
| 10SL          | 10-70506-10S | .587        | .625                     |
| 12S           | 10-70506-12  | .704        | .625                     |
| 12            | 10-70506-12  | .704        | .625                     |
| 14S           | 10-70506-14  | .828        | .625                     |
| 14            | 10-70506-14  | .828        | .625                     |
| 16S           | 10-70506-16  | .953        | .625                     |
| 16            | 10-70506-16  | .953        | .625                     |
| 18            | 10-70506-18  | 1.072       | .625                     |
| 20            | 10-70506-20  | 1.197       | .625                     |
| 22            | 10-70506-22  | 1.322       | .625                     |
| 24            | 10-70506-24  | 1.447       | .625                     |
| 28            | 10-70506-28  | 1.697       | .625                     |
| 32            | 10-70506-32  | 1.947       | .625                     |
| 36            | 10-70506-36  | 2.190       | .625                     |
| 40            | 10-70506-40  | 2.440       | .625                     |

# MS/Standard Accessories

## 10-40450, 10-36675

### sealing gaskets



The Amphenol® plain flat gasket of synthetic rubber material is provided to take complete advantage of waterproof and pressure sealing features. It is for use with the flange mounted receptacle.



This flat gasket is provided to give the maximum in connector performance. Its special feature is in providing the maximum radio shielding under difficult conditions of high receiver sensitivity and low signal strength while retaining the sealing characteristics of the plain gasket. This gasket is for use with the flange mounting receptacle.



This gasket is provided for applications where the major requirement is resistance to the injurious effects of extremely low temperature. Even at temperatures as low as -67°F this gasket retains its resiliency and will seal a pressure differential of 30 psi.

| MS Shell Size | Installation Dimensions |                  |                  |         | Order Data  |              |                 |
|---------------|-------------------------|------------------|------------------|---------|-------------|--------------|-----------------|
|               | A ±.010                 | B +.016<br>-.000 | C +.016<br>-.000 | D ±.010 | Plain       | Shielding    | Low Temperature |
| 8S            | .594                    | .500             | .875             | .172    | 10-40450-8  | 10-40450-8S  | 10-36675-8      |
| 10S           | .719                    | .625             | 1.000            | .172    | 10-40450-10 | 10-40450-10S | 10-36675-10     |
| 10SL          | .719                    | .625             | 1.000            | .172    | 10-40450-10 | 10-40450-10S | 10-36675-10     |
| 12S           | .813                    | .750             | 1.094            | .172    | 10-40450-12 | 10-40450-12S | 10-36675-12     |
| 12            | .813                    | .750             | 1.094            | .172    | 10-40450-12 | 10-40450-12S | 10-36675-12     |
| 14S           | .906                    | .875             | 1.188            | .172    | 10-40450-14 | 10-40450-14S | 10-35575-14     |
| 14            | .906                    | .875             | 1.188            | .172    | 10-40450-14 | 10-40450-14S | 10-36675-14     |
| 16S           | .969                    | 1.000            | 1.281            | .172    | 10-40450-16 | 10-40450-16S | 10-36675-16     |
| 16            | .969                    | 1.000            | 1.281            | .172    | 10-40450-16 | 10-40450-16S | 10-36675-16     |
| 18            | 1.063                   | 1.125            | 1.375            | .203    | 10-40450-18 | 10-40450-18S | 10-36675-18     |
| 20            | 1.156                   | 1.250            | 1.500            | .203    | 10-40450-20 | 10-40450-20S | 10-36675-20     |
| 22            | 1.250                   | 1.375            | 1.625            | .203    | 10-40450-22 | 10-40450-22S | 10-36675-22     |
| 24            | 1.375                   | 1.500            | 1.750            | .203    | 10-40450-24 | 10-40450-24S | 10-36675-24     |
| 28            | 1.563                   | 1.750            | 2.000            | .203    | 10-40450-28 | 10-40450-28S | 10-36675-28     |
| 32            | 1.750                   | 2.000            | 2.250            | .219    | 10-40450-32 | 10-40450-32S | 10-36675-32     |
| 36            | 1.938                   | 2.188            | 2.500            | .219    | 10-40450-36 | 10-40450-36S | 10-36675-36     |
| 40            | 2.188                   | 2.438            | 2.750            | .219    | 10-40450-40 | 10-40450-40S | 10-36675-40     |

All dimensions for reference only.

# MS/Standard solder contacts

Machined copper alloy contacts in a full range of sizes, with closed entry socket design in the size 12 and 16 contacts. A heavy silver-plated finish is deposited on all MS style solder contacts for maximum corrosion resistance, maximum current carrying capacity and low millivolt drop.

**MS/STANDARD SOLDER CONTACTS\***

| Part Number   | Pin/Socket | Mating End Size | Wire Barrel Size | Allowable Wire Size | Test Current** |
|---------------|------------|-----------------|------------------|---------------------|----------------|
| 10-40569      | Pin        | 16 Short†       | 16               | 16                  | 13             |
| 10-597107-161 | Socket     |                 |                  | 18                  | 10             |
|               |            |                 |                  | 20                  | 7.5            |
|               |            |                 |                  | 22                  | 5              |
| 10-40599      | Pin        | 16 Long         | 16               | 16                  | 13             |
| 10-597107-171 | Socket     |                 |                  | 18                  | 10             |
|               |            |                 |                  | 20                  | 7.5            |
|               |            |                 |                  | 22                  | 5              |
| 10-33646      | Pin        | 12              | 12               | 12                  | 23             |
| 10-597107-131 | Socket     |                 |                  | 14                  | 17             |
| 10-35531      | Pin        | 8               | 8                | 8                   | 46             |
| 10-35532      | Socket     |                 |                  | 10                  | 33             |
| 10-35529      | Pin        | 4               | 4                | 4                   | 80             |
| 10-35530      | Socket     |                 |                  | 6                   | 60             |
| 10-35527      | Pin        | 0               | 0                | 0                   | 150            |
| 10-35528      | Socket     |                 |                  | 1                   | 125            |
|               |            |                 |                  | 2                   | 100            |

\* Solder Wells Filled

\*\* Contact ratings as stated are test ratings only. The connector could not withstand full rated current through all contacts continuously. Please note that the electrical data given is not an establishment of electrical safety factors. This is left entirely in the designer's hands as he can best determine which peak voltage, switching surges, transients, etc. can be expected in a particular circuit.

† The 10SL, 12S, 14S and 16S connectors require short contacts.

**TABLE I  
CONTACT ARRANGEMENT SERVICE RATING**

| MS Service Rating | Recommended Operating Voltage* at Sea Level |          | Effective Creepage Distance Nom. | Mechanical Spacing Nom. |
|-------------------|---|----------|----------------------------------|-------------------------|
|                   | DC  | AC (RMS) |                                  |                         |
| Inst.             | 250   | 200      | 1/16                             |                         |
| A                 | 700   | 500      | 1/8                              | 1/16                    |
| D                 | 1250  | 900      | 3/16                             | 1/8                     |
| E                 | 1750  | 1250     | 1/4                              | 3/16                    |
| B                 | 2450  | 1750     | 5/16                             | 1/4                     |
| C                 | 4200  | 3000     | 1                                | 5/16                    |

\* The values listed in Table I represent operating values which include a generous safety factor. It may be necessary for some applications to exceed the operating voltages listed here. If this is necessary, designers will find Table II useful for determining the degree to which the recommended values of Table I can be exceeded.

**TABLE II  
ALTITUDE VOLTAGE DERATING\*\* CHART**

| MS Service Rating | Nominal Distance |          | Standard Sea Level Conditions      |                       | Pressure Altitude† 50,000 Feet     |                       | Pressure Altitude† 70,000 Feet     |                       |
|-------------------|------------------|----------|------------------------------------|-----------------------|------------------------------------|-----------------------|------------------------------------|-----------------------|
|                   | Airspace         | Creepage | Minimum Flashover Voltage AC (RMS) | Test Voltage AC (RMS) | Minimum Flashover Voltage AC (RMS) | Test Voltage AC (RMS) | Minimum Flashover Voltage AC (RMS) | Test Voltage AC (RMS) |
| Inst.             | 1/32             | 1/16     | 1400                               | 1000                  | 500                                | 400                   | 325                                | 260                   |
| A                 | 1/16             | 1/8      | 2800                               | 2000                  | 800                                | 600                   | 450                                | 360                   |
| D                 | 1/8              | 3/16     | 3600                               | 2800                  | 900                                | 675                   | 500                                | 400                   |
| E                 | 3/16             | 1/4      | 4500                               | 3500                  | 1000                               | 750                   | 550                                | 440                   |
| B                 | 1/4              | 5/16     | 5700                               | 4500                  | 1100                               | 825                   | 600                                | 480                   |
| C                 | 5/16             | 1        | 8500                               | 7000                  | 1300                               | 975                   | 700                                | 560                   |

† Not corrected for changes in density due to variations in temperature.

\*\* No attempt has been made to recommend operating voltages. The designer must determine his own operating voltage by the application of a safety factor to the above derating chart to compensate for circuit transients, surges, etc.

# MS/Standard crimp contacts

Machined from copper alloy and silver-plated for maximum corrosion resistance, with a minimum millivolt drop and a maximum current carrying capacity, the size 16 and 12 socket contacts are of the closed entry design. Crimp contacts are available for all MS insert arrangements and are identified with an Amphenol® proprietary number.

## MS/STANDARD CRIMP CONTACTS

| Part Number               | Pin/Socket | Mating End Size | Wire Barrel Size | Allowable Wire Size | Required Wire Adapter Sleeve | Test Current** Amps |
|---------------------------|------------|-----------------|------------------|---------------------|------------------------------|---------------------|
| 10-40553                  | Pin        | 16 Short†       | 16               | 16                  | 10-74696-6                   | 13                  |
| 10-40552 or 10-597109-161 | Socket     |                 |                  | 18                  |                              | 10                  |
|                           |            |                 |                  | 20                  |                              | 7.5                 |
|                           |            |                 |                  | 22*                 |                              | 5                   |
| 10-40557                  | Pin        | 16 Long         | 16               | 16                  | 10-74696-6                   | 13                  |
| 10-40556 or 10-597109-171 | Socket     |                 |                  | 18                  |                              | 10                  |
|                           |            |                 |                  | 20                  |                              | 7.5                 |
|                           |            |                 |                  | 22*                 |                              | 5                   |
| 10-40561                  | Pin        | 12              | 12               | 12                  |                              | 23                  |
| 10-40560 or 10-597109-131 | Socket     |                 |                  | 14                  |                              | 17                  |
| 10-40792                  | Pin        | 8               | 8                | 8                   | 10-74696-1                   | 46                  |
| 10-40793                  | Socket     |                 |                  | 10*                 |                              | 33                  |
| 10-40564                  | Pin        | 4               | 4                | 4                   | 10-74696-2                   | 80                  |
| 10-40565                  | Socket     |                 |                  | 6*                  |                              | 60                  |
| 10-40562 or 10-581806     | Pin        | 0               | 0                | 0                   |                              | 150                 |
| 10-40563 or 10-581808     | Socket     |                 |                  | 2*                  |                              | 100                 |

\* When using wire adapter sleeve shown.

\*\* Contact ratings as stated are test ratings only. The connector could not withstand full rated current through all contacts continuously. Please note that the electrical data given is not an establishment of electrical safety factors. This is left entirely in the designer's hands as he can best determine which peak voltage, switching surges, transients, etc. can be expected in a particular circuit.

† The 10SL, 12S, 14S and 16S connectors require short contacts.

## TABLE I

### CONTACT ARRANGEMENT SERVICE RATING

| MS Service Rating | Recommended Operating Voltage* at Sea Level |          | Effective Creepage Distance Nom. | Mechanical Spacing Nom. |
|-------------------|---|----------|----------------------------------|-------------------------|
|                   | DC  | AC (RMS) |                                  |                         |
| Inst.             | 250   | 200      | 1/16                             |                         |
| A                 | 700   | 500      | 1/8                              | 1/16                    |
| D                 | 1250  | 900      | 3/16                             | 1/8                     |
| E                 | 1750  | 1250     | 1/4                              | 3/16                    |
| B                 | 2450  | 1750     | 5/16                             | 1/4                     |
| C                 | 4200  | 3000     | 1                                | 5/16                    |

\* The values listed in Table I represent operating values which include a generous safety factor. It may be necessary for some applications to exceed the operating voltages listed here. If this is necessary, designers will find Table II useful for determining the degree to which the recommended values of Table I can be exceeded.

## TABLE II

### ALTITUDE VOLTAGE DERATING\*\* CHART

| MS Service Rating | Nominal Distance |          | Standard Sea Level Conditions      |                       | Pressure Altitude† 50,000 Feet     |                       | Pressure Altitude† 70,000 Feet     |                       |
|-------------------|------------------|----------|------------------------------------|-----------------------|------------------------------------|-----------------------|------------------------------------|-----------------------|
|                   | Airspace         | Creepage | Minimum Flashover Voltage AC (RMS) | Test Voltage AC (RMS) | Minimum Flashover Voltage AC (RMS) | Test Voltage AC (RMS) | Minimum Flashover Voltage AC (RMS) | Test Voltage AC (RMS) |
| Inst.             | 1/32             | 1/16     | 1400                               | 1000                  | 500                                | 400                   | 325                                | 260                   |
| A                 | 1/16             | 1/8      | 2800                               | 2000                  | 800                                | 600                   | 450                                | 360                   |
| D                 | 1/8              | 3/16     | 3600                               | 2800                  | 900                                | 675                   | 500                                | 400                   |
| E                 | 3/16             | 1/4      | 4500                               | 3500                  | 1000                               | 750                   | 550                                | 440                   |
| B                 | 1/4              | 5/16     | 5700                               | 4500                  | 1100                               | 825                   | 600                                | 480                   |
| C                 | 5/16             | 1        | 8500                               | 7000                  | 1300                               | 975                   | 700                                | 560                   |

† Not corrected for changes in density due to variations in temperature.

\*\* No attempt has been made to recommend operating voltages. The designer must determine his own operating voltage by the application of a safety factor to the above derating chart to compensate for circuit transients, surges, etc.

# MS/Standard application tools

When proprietary crimp contacts are employed rather than the standard MS approved solder contacts, the following application tools are recommended for use. There is a possibility of additional crimping tools other than those included being available at present or in the future for this specific application.

Complete instructions for providing reliable crimped wire to contact terminations and inserting proprietary crimp contacts in MS/Standard series connectors are available in publication L-757.

**TOOLING CHART**

| Crimping Tool | Positioner/<br>Turret | Contact Size | Contact Style | Insertion Tool | Removal Tool                        |
|---------------|-----------------------|--------------|---------------|----------------|-------------------------------------|
| M22520/1-01   | *                     | 16           | Pin & Socket  | 11-7345        | 11-8250 Kit                         |
| M22520/1-01   | *                     | 12           | Pin & Socket  | 11-7082        | 11-8250 Kit                         |
| **            | **                    | 8            | Pin & Socket  | 11-8220        | 11-8250 Kit                         |
| **            | **                    | 4            | Pin & Socket  | 11-7365-4†     | Pin 11-7370-4†<br>Socket 11-7674-2† |
| **            | **                    | 0            | Pin & Socket  | 11-7365-5†     | Pin 11-7370-5†<br>Socket 11-7674-3† |

\* Use Daniels Turret TH29-1 or Astro Tool Co. Turret 616266.

\*\* For appropriate crimp tool and positioner refer to Pico Crimping Tool Co.

† Tool used with Arbor press 11-7364.

# MS/Standard how to order

## MIL-DTL-5015 and MIL-5015 Type (Solder Contacts)

MS   3102   A   18-3   P   W   (SR)  
 1        2        3        4 5       6        7        8

1. Connector Type  
 MS designates Military Standard  
 CS\* designates service class A and C with proprietary special contact arrangements  
 SG\* designates service class E with proprietary special contact arrangements  
 SM\* designates service class F and R with proprietary special contact arrangements
2. Connector Style  
 3100 wall mounting receptacle  
 3101 cable connecting plug  
 3102 box mounting receptacle  
 3106 straight plug  
 3108 90° plug
3. Service Class  
 A solid shell for general, non-environmental applications  
 C solid shell for pressurized applications  
 E environmental resisting  
 F environmental resisting with strain relief (MS part number only)  
 R lightweight environmental resisting
- 4., 5. Shell size and insert arrangement - see tables, pages 22-24.
6. Contact Types  
 P designates pin contact  
 S designates socket contact
7. Insert Rotation  
 "W", "X", "Y", or "Z" designate that insert is rotated in its shell from normal position. No letter required for normal (no rotation) position.
8. (SR) strain relief for non-military connectors (For MS use "F" class)

\* For insert arrangements over 50 and shell size 40 and above.  
 Exceptions: 36-52, 40-1, 40-9 and 40-56 are MS approved.

Consult Amphenol, Sidney, NY for availability of alternate finishes, including black and olive drab zinc alloys.

## Proprietary (Crimp Contacts)

75 - 68   0   12-3   H  
 1        2        3        4 5       6

1. Connector Type  
 75 – connector utilizing silver plated contacts  
 80 – less contacts  
 85 – contacts utilizing 50 micro-inches gold over silver plating
2. Service Class  
 68 service class A, general duty  
 474 service class F, environmental resisting  
 190 service class R, lightweight environmental resisting
3. Connector Style  
 0 wall mounting receptacle  
 1 cable connecting plug  
 2 box mounting receptacle  
 6 straight plug  
 8 90° plug
4. Shell Size Designator

|                  |    |     |      |     |    |     |    |     |    |    |
|------------------|----|-----|------|-----|----|-----|----|-----|----|----|
| Shell Size       | 8S | 10S | 10SL | 12S | 12 | 14S | 14 | 16S | 16 | 18 |
| Shell Designator | 8  | 10  | 11   | 12  | 13 | 14  | 15 | 16  | 17 | 18 |

|                  |    |    |    |    |    |    |    |    |    |  |
|------------------|----|----|----|----|----|----|----|----|----|--|
| Shell Size       | 20 | 22 | 24 | 28 | 32 | 36 | 40 | 44 | 48 |  |
| Shell Designator | 20 | 22 | 24 | 28 | 32 | 36 | 40 | 44 | 48 |  |

5. Insert Arrangements  
 See page 22-24.
6. Contact Type/Alternate Insert Rotation  
 P designates pin, S designates socket for normal positioning of inserts. When an alternate position of the connector insert is required to prevent cross-mating, a different letter (other than P or S) is used. See page 25 for description of alternate positions, then convert to Amphenol® proprietary coding by the following charts:

| Pin Contacts |                 | Socket Contacts |                 |
|--------------|-----------------|-----------------|-----------------|
| MS Letter    | Amphenol Letter | MS Letter       | Amphenol Letter |
| PW           | G               | SW              | H               |
| PX           | I               | SX              | J               |
| PY           | K               | SY              | L               |
| PZ           | M               | SZ              | N               |

# Additional MS/Standard Connectors offered by Amphenol

## MS/Standard MIL-DTL-5015\* Connectors with Crimp Rear Release Contacts

Amphenol broadens their MS/Standard family of connectors with the addition of the Matrix® MIL-DTL-5015 crimp rear release series. This series bridges the gap between the old connector standard and the environmental and high performance needs of current technologies.

Design characteristics of the Amphenol/Matrix 5015 series include:

- MS345( ) series intermateable with existing MIL-DTL-5015 solder or crimp versions on existing equipment
- Captive coupling nut mechanism, utilizes retaining rings in combination with "L" washers to prevent inadvertent disassembly
- Multiple interlock systems ensure permanent insert retention
- Positive control of dielectric separation with guaranteed ease of contact insertion
- Positive contact retention provided by a closely toleranced damage-proof metal retention clip
- Completely sealed against environmental extremes with individual contact seals, interfacial seals between contacts, peripheral gasket shell-to-shell seals and rear wire seals

### Customer Options

- Seven mounting styles, in shell sizes 8 to 48 (consult Amphenol for availability of shell sizes 44 and 48)
- Threaded coupling or self-locking plug (MS3459) with an internal ratcheting mechanism to prevent unmating due to vibration and shock, eliminating the need for safety wiring
- Proprietary quick disconnect plug, with or without lanyard available
- Classes include aluminum or stainless steel shells, or firewall capability
- MS and Proprietary versions available
- Some styles are supplied to McDonnell Douglas Specification BAN 7025, DC60 Series
- Accommodation of contact sizes 0 to 16
- Over 100 insert arrangement patterns available, accommodating from 1 to a maximum of 85 circuits
- Alternate positioning available; thermocouple contacts available

Ask for Amphenol catalog 12-026 for detailed information.

## MIL-5015 Modifications

In order to supplement standard MS shell styles and provide a greater variety of styles for the electrical connector user, there are several MS and MS Modified cylindrical connectors offered by Amphenol. These types include flange mount plugs, thru bulkhead receptacles, jam nut receptacles, connectors for potting and connectors designed specifically to terminate jacketed cable.

Ask for Amphenol catalog 12-021 for detailed information.

## 97 Series, MIL-5015 Type Connectors

The low cost, general duty connector used extensively in the machine tool industry, welding industry and numerous other industrial applications, is the Amphenol® 97 Series. Offered in non-environmental styles, these connectors have hard dielectric inserts and threaded coupling. They are Underwriters Laboratories Recognized and Canadian Standards Association Certified.

Ask for Amphenol catalog 12-022 for detailed information.

## Pre-Earth FMLB Connectors

Designed for applications where a protective circuit from the ground contact to the shell is a safety requirement, Pre-earth connectors use MIL-5015 type shells, inserts and arrangements. They have first mate, last break capability; when mated this feature protects operators and sensitive circuits.

Ask for Product Data Sheet PDS 187 for detailed information.



Amphenol®/Matrix® MS/Standard MIL-C-5015 Connectors with Crimp Rear Release Contacts



97 Series, MIL-C-5015 Type Connectors

\* Note: MIL-DTL-5015 supercedes MIL-C-5015 for all Amphenol/Matrix rear release crimp type connectors.



# Additional MS/Standard Connectors offered by Amphenol, cont.

## Amphe-Power™ 5015 Connectors

Amphenol offers the AC threaded series derived from the MIL-5015 family that can be enhanced with high amperage RADSOK® contacts.

Design characteristics of the Amphe-Power 5015 connectors are:

- The RADSOK contact handles up to 150% higher amperages than standard contacts
- The RADSOK contact has a twisted hyperbolic, stamped grid configuration within the socket. This design ensures a large, coaxial, face-to-face surface area engagement. As male pin is inserted, axial members in the female half deflect, imparting high current flow across the connection with minimal voltage loss.
- Contact arrangements have RADSOK sockets in sizes 0, 4 and 8 with standard contacts in sizes 16 and 12.

The contacts available in RADSOK and the amperages are as follows:

- Size 8 AWG can handle currents up to 69 amps.
- Size 4 AWG can handle currents up to 120 amps.
- Size 0 AWG can handle currents up to 250 amps.

(For availability of size 12 RADSOK that handles currents up to 35 amps, consult Amphenol.)

- AC threaded 5015 styles include: solid shell for general, non-environmental applications; pressurized style for use on pressurized bulkheads or pressure barriers; environmental resisting style with strain relief; lighter weight and shorter environmental resisting style

For more information ask for Amphenol brochure SL-391, Amphe-Power Connectors with RADSOK technology.



**Amphe-Power® 5015 Connectors  
(AC Threaded 5015 type connectors with RADSOK® high amperage contacts)**



**The RADSOK design - socket cylinder within female contact has twisted hyperbolic grid. Provides higher amperage capabilities with low insertion force and low temperature rise.**

## MIL-5015 Connectors with PCB Contacts

Box mount receptacle MIL-5015 type connectors can be supplied with PCB tails for mounting to a printed circuit board.

See catalog 12-170, Amphenol Cylindrical Connectors for Printed Circuit Board Applications. This catalog gives the most commonly available and widely used insert patterns for cylindrical connectors with PCB tails, along with pin-out location diagrams.

