

Compact Photoelectric Sensor with Built-in Amplifier

E3Z-F

A Visible Spot That Simplifies the Usage of Photoelectric Sensors

- E3Z-F is added to the E3Z Series of Photoelectric Sensors that boasts annual worldwide sales of 1.5 million units.
- Many different sensing distances
Diffuse-reflective: 100 mm, 300 mm, 500 mm, 1 m
Through-beam: 20 m
Retro-reflective: 4 m
- Models with infrared LEDs are also available.



For the most recent information on models that have been certified for safety standards, refer to your OMRON website.

 Refer to the *Safety Precautions* on page 9.

Features

Visible spot for easy installation



Many different sensing distances are available, so you can select the best model for your application distance.

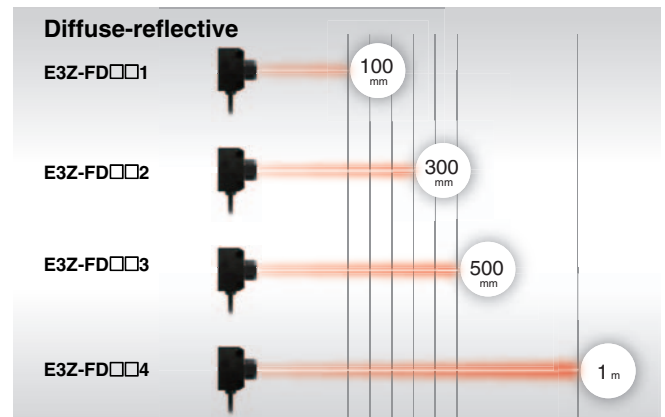

Application

Materials handling: detect passing cardboard boxes

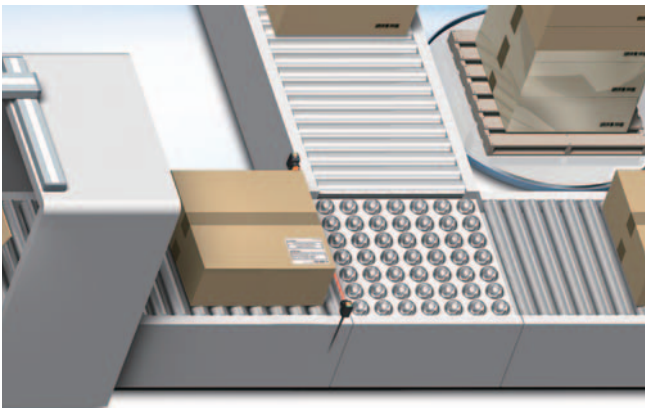

Molding machines: detect falling molded objects

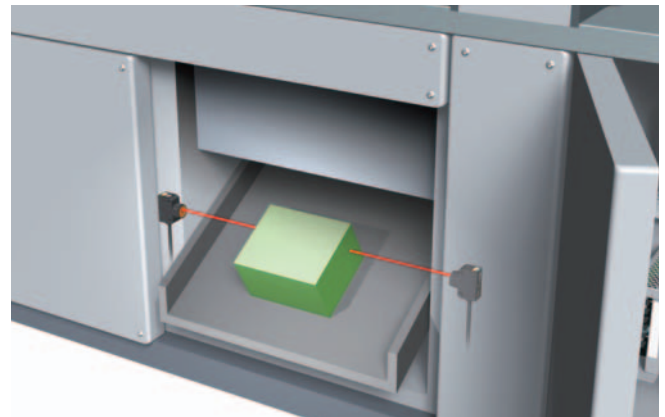









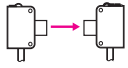

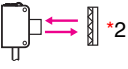

E3Z-F

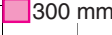
Ordering Information

Sensors [Refer to Dimensions on page 10.]

 Red light  Infrared light

Sensing method	Appearance	Connecting method	Sensing distance	Model	
				NPN output	PNP output
Through-beam (Emitter + Receiver)		Pre-wired (2 m)		E3Z-FTN11 2M *1 Emitter E3Z-FTN11-L 2M Receiver E3Z-FTN11-D 2M	E3Z-FTP11 2M *1 Emitter E3Z-FTP11-L 2M Receiver E3Z-FTP11-D 2M
		Connector (M12)		E3Z-FTN21 *1 Emitter E3Z-FTN21-L Receiver E3Z-FTN21-D	E3Z-FTP21 *1 Emitter E3Z-FTP21-L Receiver E3Z-FTP21-D
		Pre-wired (2 m)		E3Z-FTN12 2M *1 Emitter E3Z-FTN12-L 2M Receiver E3Z-FTN12-D 2M	E3Z-FTP12 2M *1 Emitter E3Z-FTP12-L 2M Receiver E3Z-FTP12-D 2M
		Connector (M12)		E3Z-FTN22 *1 Emitter E3Z-FTN22-L Receiver E3Z-FTN22-D	E3Z-FTP22 *1 Emitter E3Z-FTP22-L Receiver E3Z-FTP22-D
Retro-reflective with MSR function		Pre-wired (2 m)		E3Z-FRN11 2M	E3Z-FRP11 2M
		Connector (M12)		E3Z-FRN21	E3Z-FRP21
Diffuse-reflective		Pre-wired (2 m)		E3Z-FDN11 2M	E3Z-FDP11 2M
		Connector (M12)		E3Z-FDN21	E3Z-FDP21
		Pre-wired (2 m)		E3Z-FDN12 2M	E3Z-FDP12 2M
		Connector (M12)		E3Z-FDN22	E3Z-FDP22
		Pre-wired (2 m)		E3Z-FDN13 2M	E3Z-FDP13 2M
		Connector (M12)		E3Z-FDN23	E3Z-FDP23
		Pre-wired (2 m)		E3Z-FDN14 2M	E3Z-FDP14 2M
		Connector (M12)		E3Z-FDN24	E3Z-FDP24
		Pre-wired (2 m)		E3Z-FDN15 2M	E3Z-FDP15 2M
		Connector (M12)		E3Z-FDN25	E3Z-FDP25
		Pre-wired (2 m)		E3Z-FDN16 2M	E3Z-FDP16 2M
		Connector (M12)		E3Z-FDN26	E3Z-FDP26
		Pre-wired (2 m)		E3Z-FDN17 2M	E3Z-FDP17 2M
		Connector (M12)		E3Z-FDN27	E3Z-FDP27
		Pre-wired (2 m)		E3Z-FDN18 2M	E3Z-FDP18 2M
		Connector (M12)		E3Z-FDN28	E3Z-FDP28

*1. Through-beam Sensors are normally sold in sets that include both the Emitter and Receiver. An order for the Emitter or Receiver alone cannot be accepted.

*2. The Reflector is sold separately. Select the Reflector model most suited to the application.

*3. Values in parentheses indicate the minimum required distance between the Sensor and Reflector.

Accessories (Sold Separately)

Reflector (Required for Retro-reflective Sensors) A Reflector is not provided with the Sensor. It must be ordered separately.
 [Refer to *Dimensions on page 11.*]

Appearance	Sensing distance*		Model	Quantity	Remarks
	Rated value	Reference value			
	4 m (100 mm)	---	E39-R1S	1	for E3Z-FR□

* Values in parentheses indicates the minimum required distance between the Sensor and Reflector.

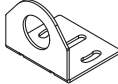

Mounting Brackets A Mounting Bracket is not provided with the Sensor. It must be ordered separately as required.
 [Refer to *Dimensions on page 11.*]

Applicable Sensors	Mounting method	Appearance	Model	Quantity
All models	M3 screw mounting		E39-L189	1
	M18 nut side mounting		E39-L183	1

Note: 1. When using Through-beam models, order one bracket for the Receiver and one for the Emitter.

Sensor I/O Connectors (Sockets on One Cable End)

(Required for models for Connectors) A Connector is not provided with the Sensor. It must be ordered separately.

Applicable Sensors	Size	Cable	Appearance	Cable type		Model	
Connector (M12)	M12	Standard	Straight		2 m	4 conductors	XS2F-M12PVC4S2M
					5 m		XS2F-M12PVC4S5M
			L-shaped		2 m		XS2F-M12PVC4A2M
					5 m		XS2F-M12PVC4A5M

Note: When using Through-beam models, order one sensor I/O connector for the Receiver and one for the Emitter.

Ratings and Specifications

Item	Sensing method		Through-beam	Retro-reflective with MSR function	Diffuse-reflective			
	Model				E3Z-FTN11	E3Z-FRN11	E3Z-FDN11	E3Z-FDN12
	NPN output	Pre-wired	E3Z-FTN11	E3Z-FRN11	E3Z-FDN11	E3Z-FDN12	E3Z-FDN13	E3Z-FDN14
		Connector (M12)	E3Z-FTN21	E3Z-FRN21	E3Z-FDN21	E3Z-FDN22	E3Z-FDN23	E3Z-FDN24
	PNP output	Pre-wired	E3Z-FTP11	E3Z-FRP11	E3Z-FDP11	E3Z-FDP12	E3Z-FDP13	E3Z-FDP14
		Connector (M12)	E3Z-FTP21	E3Z-FRP21	E3Z-FDP21	E3Z-FDP22	E3Z-FDP23	E3Z-FDP24
Sensing distance			20 m	4 m (100 mm) *1 (when using E39-R1S)	100 mm (white paper: 300 × 300 mm)	300 mm (white paper: 300 × 300 mm)	500 mm (white paper: 300 × 300 mm)	1 m (white paper: 300 × 300 mm)
Spot diameter (reference value)			---		40 × 45 mm (at sensing distance of 100 mm)	40 × 50 mm (at sensing distance of 300 mm)	45 × 50 mm (at sensing distance of 500 mm)	120 × 150 mm (at sensing distance of 1 m)
Standard sensing object			Opaque: 7 mm dia. min.	Opaque: 75 mm dia. min.	---			
Differential travel			---		20% max. of sensing distance			
Directional angle			2° min.		---			
Light source (wavelength)			Red LED (624 nm)					
Power supply voltage			10 to 30 VDC (including voltage ripple of 10% (p-p) max.)					
Current consumption			40 mA max. (Emitter: 25 mA max., Receiver: 15 mA max.)	25 mA max.				
Control output			Load power supply voltage: 30 VDC max., Load current: 100 mA max. (Residual voltage: 3 V max.) Open collector output (NPN (negative common)/PNP (positive common) depending on model) Light-ON/Dark-ON cable connection selectable					
Indicators			Operation indicator (orange) Stability indicator (green) Trough-beam Emitter has only power indicator (green).					
Protection circuits			Power supply reverse polarity protection, Output short-circuit protection, and Output reverse polarity protection					
Response time			Operate or reset: 0.5 ms max.					
Sensitivity adjustment			One-turn adjuster					
Ambient illumination (Receiver side)			Incandescent lamp: 3,000 lx max. Sunlight: 10,000 lx max.					
Ambient temperature range			Operating: -25 to 55°C, Storage: -40°C to 70°C (with no icing or condensation)					
Ambient humidity range			Operating: 35% to 85%, Storage: 35% to 95% (with no condensation)					
Insulation resistance			20 MΩ min. (at 500 VDC)					
Dielectric strength			1,000 VAC, at 50/60 Hz for 1 min					
Vibration resistance (destruction)			10 to 55 Hz with a 1.5 mm double amplitude for 2 hours each in X, Y, and Z directions					
Shock resistance (destruction)			500 m/s ² for 3 times each in X, Y, and Z directions					
Degree of protection *2			IEC IP67, DIN40050-9 standard IP69K					
Connecting method			Pre-wired (standard length: 2 m), Connector (M12, 4-Pin)					
Weight (packedstate/Sensor only)	Pre-wired		Approx. 120 g/ Approx. 105 g	Approx. 70 g/ Approx. 55 g				
	Connector		Approx. 35 g/ Approx. 20 g	Approx. 25 g/ Approx. 10 g				
Materials	Case		ABS					
	Lens		Methacrylic resin (PMMA)					
	Display		Methacrylic resin (PMMA)					
	Sensitivity adjuster		Polyacetal (POM)					
	Cable *3		Vinyl chloride (PVC)					
Nuts		ABS						
Accessories			Nuts (2 pcs), Instruction manual	Nut (1 pcs), Instruction manual				

*1. Values in parentheses indicate the minimum required distances between the Sensors and Reflectors.

*2. IP69K Degree of Protection Specifications.

IP69K is a protection specification stipulated by DIN 40050 Part 9 of the German standards. The test item is sprayed with 80°C water from a nozzle of a specified shape at a water pressure of 80 to 100 bar. The amount of water is 14 to 16 liters per minute.

The distance between the test item and the nozzle is 10 to 15 cm. The water is discharged at angles of 0°, 30°, 60°, and 90° from the horizontal plane for 30 seconds at each angle while the test item is rotated horizontally.

*3. Only for Pre-wired models.

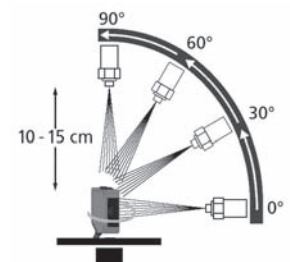

Item	Sensing method		Through-beam	Diffuse-reflective			
	Model	NPN output	E3Z-FTN12	E3Z-FDN15	E3Z-FDN16	E3Z-FDN17	E3Z-FDN18
		Connector (M12)	E3Z-FTN22	E3Z-FDN25	E3Z-FDN26	E3Z-FDN27	E3Z-FDN28
	PNP output	Pre-wired	E3Z-FTP12	E3Z-FDP15	E3Z-FDP16	E3Z-FDP17	E3Z-FDP18
Connector (M12)		E3Z-FTP22	E3Z-FDP25	E3Z-FDP26	E3Z-FDP27	E3Z-FDP28	
Sensing distance			20 m	100 mm (white paper: 300 × 300 mm)	300 mm (white paper: 300 × 300 mm)	500 mm (white paper: 300 × 300 mm)	1 m (white paper: 300 × 300 mm)
Spot diameter (reference value)			---				
Standard sensing object			Opaque: 7 mm dia. min.	---			
Differential travel			---	20% max. of sensing distance			
Directional angle			2° min.		---		
Light source (wavelength)			Infrared LED (850 nm)				
Power supply voltage			10 to 30 VDC (including voltage ripple of 10% (p-p) max.)				
Current consumption			40 mA max. (Emitter: 25 mA max., Receiver: 15 mA max.)	25mA max.			
Control output			Load power supply voltage: 30 VDC max., Load current: 100 mA max. (Residual voltage: 3 V max.) Open collector output (NPN (negative common)/PNP (positive common) depending on model) Light-ON/Dark-ON cable connection selectable				
Indicators			Operation indicator (orange) Stability indicator (green) Through-beam Emitter has only power indicator (green).				
Protection circuits			Power supply reverse polarity protection, Output short-circuit protection, and Output reverse polarity protection				
Response time			Operate or reset: 0.5 ms max.				
Sensitivity adjustment			One-turn adjuster				
Ambient illumination (Receiver side)			Incandescent lamp: 3,000 lx max. Sunlight: 10,000 lx max.				
Ambient temperature range			Operating: -25 to 55°C, Storage: -40°C to 70°C (with no icing or condensation)				
Ambient humidity range			Operating: 35% to 85%, Storage: 35% to 95% (with no condensation)				
Insulation resistance			20 MΩ min. (at 500 VDC)				
Dielectric strength			1,000 VAC, at 50/60 Hz for 1 min				
Vibration resistance (destruction)			10 to 55 Hz with a 1.5 mm double amplitude for 2 hours each in X, Y, and Z directions				
Shock resistance (destruction)			500 m/s ² for 3 times each in X, Y, and Z directions				
Degree of protection *1			IEC IP67, DIN40050-9 standard IP69K				
Connecting method			Pre-wired (standard length: 2 m), Connector (M12, 4-Pin)				
Weight (packed state/Sensor only)	Pre-wired	Approx. 120 g/ Approx. 105 g	Approx. 70 g/ Approx. 55 g				
	Connector	Approx. 35 g/ Approx. 20 g	Approx. 25 g/ Approx. 10 g				
Materials	Case	ABS					
	Lens	Methacrylic resin (PMMA)					
	Display	Methacrylic resin (PMMA)					
	Sensitivity adjuster	Polyacetal (POM)					
	Cable *2	Vinyl chloride (PVC)					
Nuts	ABS						
Accessories			Nuts (2 pcs), Instruction manual	Nut (1 pcs), Instruction manual			

*1. IP69K Degree of Protection Specifications.
 IP69K is a protection specification stipulated by DIN 40050 Part 9 of the German standards.
 The test item is sprayed with 80°C water from a nozzle of a specified shape at a water pressure of 80 to 100 bar. The amount of water is 14 to 16 liters per minute.
 The distance between the test item and the nozzle is 10 to 15 cm. The water is discharged at angles of 0°, 30°, 60°, and 90° from the horizontal plane for 30 seconds at each angle while the test item is rotated horizontally.

*2. Only for Pre-wired models.

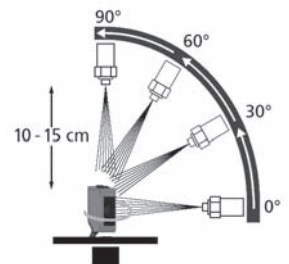

E3Z-F

Engineering Data (Reference Value)

Parallel Operating Range

Through-beam

E3Z-FT□□1/-FT□□2

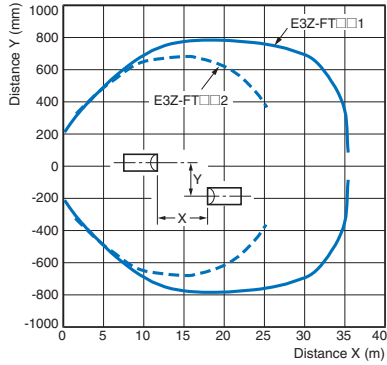

Retro-reflective

E3Z-FR□□

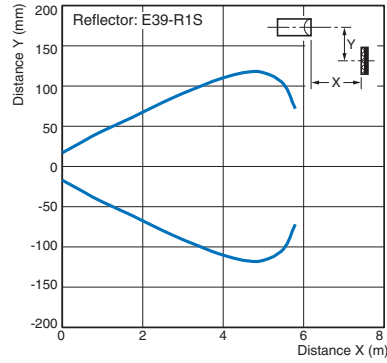

Operating Range

Diffuse-reflective

E3Z-FD□□1/-FD□□2

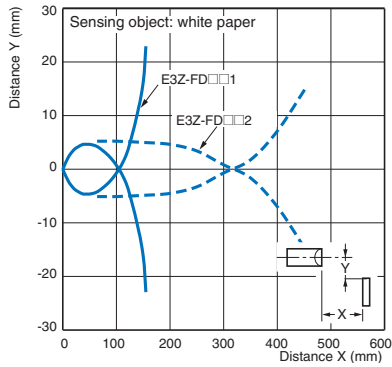

Diffuse-reflective

E3Z-FD□□3/-FD□□4

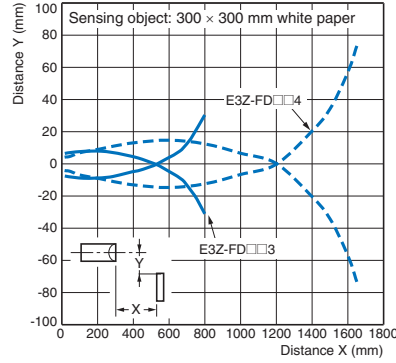

Diffuse-reflective

E3Z-FD□□5/-FD□□6

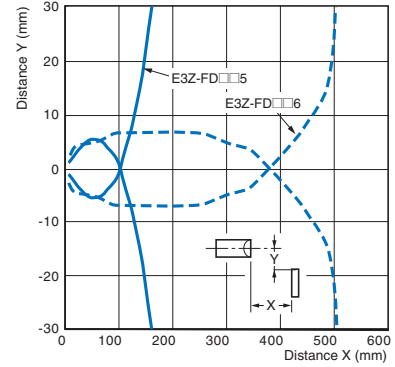

Diffuse-reflective

E3Z-FD□□7/-FD□□8

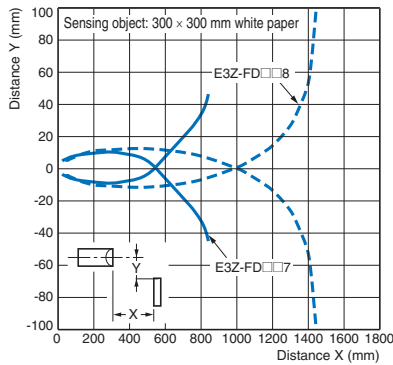

Excess Gain vs. Distance

Through-beam

E3Z-FT□□1/-FT□□2

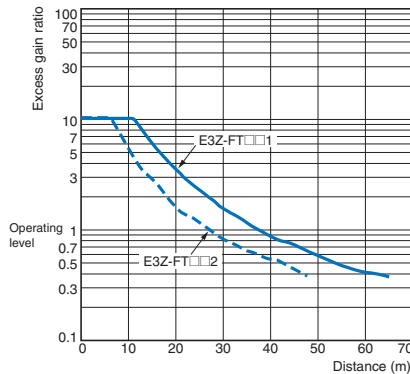

Retro-reflective

E3Z-FR□□

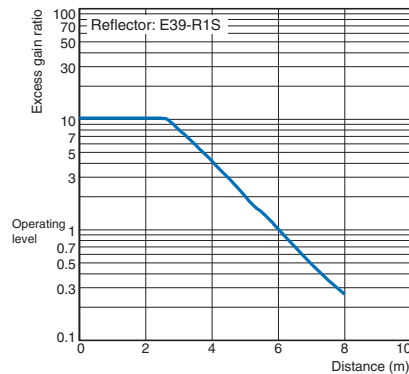

Excess Gain vs. Distance

Diffuse-reflective

E3Z-FD001/-FD002

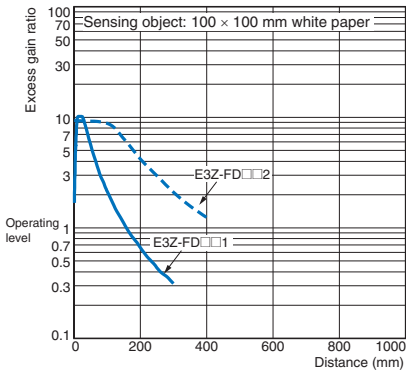

Diffuse-reflective

E3Z-FD003/-FD004

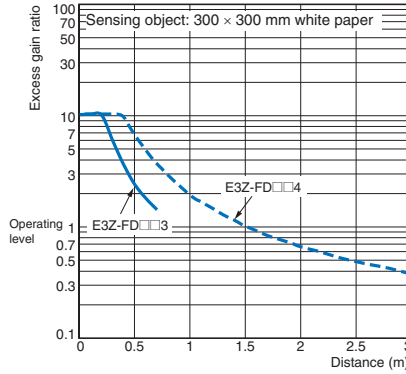

Diffuse-reflective

E3Z-FD005/-FD006

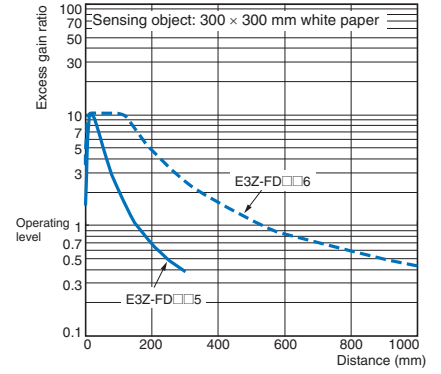

Diffuse-reflective

E3Z-FD007/-FD008

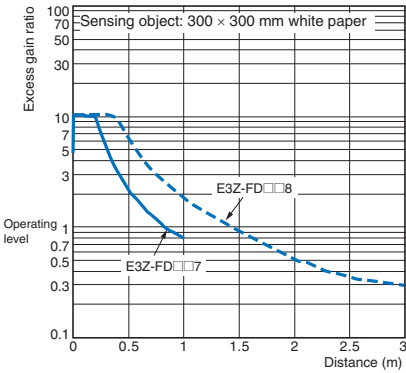

Sensing Object Size vs. Distance

Diffuse-reflective

E3Z-FD001/-FD002

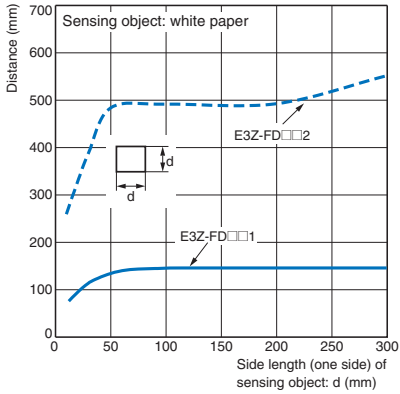

Diffuse-reflective

E3Z-FD003/-FD004

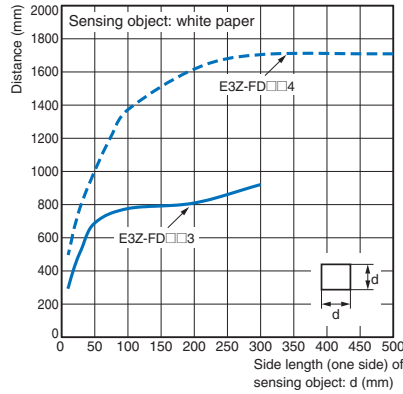

Diffuse-reflective

E3Z-FD005/-FD006

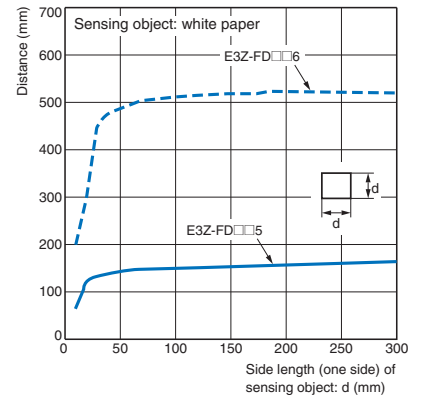

Diffuse-reflective

E3Z-FD007/-FD008

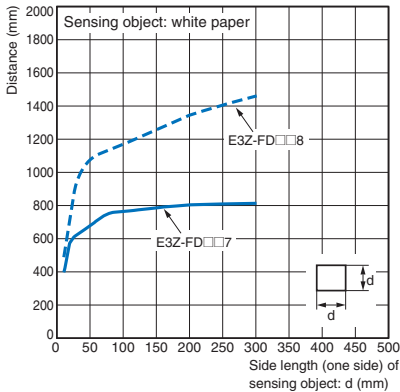

E3Z-F

I/O Circuit Diagrams

NPN Output

Model	Operation mode	Timing charts	Operation selector	Output circuit
E3Z-FTN□□ E3Z-FRN□□ E3Z-FDN□□	Light-ON	Incident light No incident light Operation indicator (orange) ON OFF Output transistor ON OFF Load Operate (e.g., relay) Reset (Between brown (1) and black (4) leads)	Connect pink lead (2) to brown lead (1) or leave open.	Through-beam Receivers, Retro-reflective, Diffuse-reflective.
	Dark-ON	Incident light No incident light Operation indicator (orange) ON OFF Output transistor ON OFF Load Operate (e.g., relay) Reset (Between brown (1) and black (4) leads)	Connect pink lead (2) to blue lead (3).	
	Through-beam Emitter			

PNP Output

Model	Operation mode	Timing charts	Operation selector	Output circuit
E3Z-FTP□□ E3Z-FRP□□ E3Z-FDP□□	Light-ON	Incident light No incident light Operation indicator (orange) ON OFF Output transistor ON OFF Load Operate (e.g., relay) Reset (Between blue (3) and black (4) leads)	Connect pink lead (2) to brown lead (1).	Through-beam Receivers, Retro-reflective, Diffuse-reflective.
	Dark-ON	Incident light No incident light Operation indicator (orange) ON OFF Output transistor ON OFF Load Operate (e.g., relay) Reset (Between blue (3) and black (4) leads)	Connect pink lead (2) to blue lead (3) or leave open.	
	Through-beam Emitter			

Connector Pin Arrangement

M12 Connector Pin Arrangement

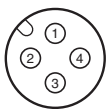

Plugs (Sensor I/O Connectors)

M12, 4-pin Connectors

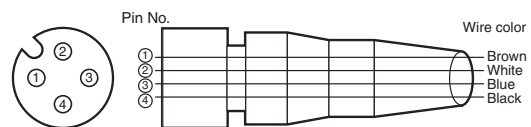

Pin arrangement

Classification	Wire color	Connector pin No.	Application
DC	Brown	1	Power supply (+V)
	White	2	L/on · D/on selectable
	Blue	3	Power supply (0 V)
	Black	4	Output

Safety Precautions

To ensure safe operation, be sure to read and follow the Instruction Manual provided with the sensor.

■ Meanings of Alert symbols

 WARNING	Indicates a potentially hazardous situation which, if not avoided, will result in minor or moderate injury, or may result in serious injury or death. Additionally there may be significant property damage.
--	--

 CAUTION	Indicates a potentially hazardous situation which, if not avoided, may result in minor or moderate injury or in property damage.
--	--

Precautions for Safe Use	Supplementary comments on what to do or avoid doing, to use the product safety.
---------------------------------	---

Precautions for Correct Use	Supplementary comments on what to do or avoid doing, to prevent a failure to operate, or undesirable effect on product performance.
------------------------------------	---

 WARNING
--

This product is not designed or rated for ensuring safety of persons either directly or indirectly. Do not use it for such purposes.



 CAUTION
--

Explosion, fire, or product malfunction may occur. Never use the product with an AC power supply. Do not use the product with voltage in excess of the rated voltage. Do not use the product with incorrect wiring.



Precautions for Safe Use

Be sure to follow the safety precautions below for added safety.

1. Do not use the product in atmospheres or environments that exceed product ratings.
2. Do not use the product in an environment where it may be exposed to inflammable or explosive gas.
3. Do not use the product in an environment where it may be exposed to oil or chemicals.
4. Do not use the product in water, in rain, or outdoors.
5. Do not use the product in locations subject to condensation due to high humidity.
6. Do not use the product in any other environment that exceeds the ratings.
7. Do not use the product in a location subject to direct sunlight.
8. Do not use the product in a location subject to direct vibration or shock.
9. Do not use organic solvents (such as thinners or alcohol).
10. Do not attempt to disassemble, repair, or modify the product.
11. Dispose of the product as industrial waste.
12. The E3Z-F devices shall be used with Class2 power supply in the United States.
The ampere rating of the current protection shall be 1A for 26AWG, 2A for 24AWG, 3A for 22AWG, 5A for 20AWG.

Precautions for Correct Use

1. Laying Sensor wiring in the same conduit or duct as high-voltage wires or power lines may result in malfunction or damage due to conduit or use shielded cable. Separate the Sensor wiring or use a shielded cable.
2. Do not pull on the cable with excessive force.
3. If a commercial switching regulator is used, ground the FG (frame ground) terminal.
4. The sensor will be available 100 ms after the power supply is tuned ON. Start to use the sensor 100 ms or more after turning ON the power supply. If the load and the sensor are connected to separate power supplies, be sure to turn ON the sensor first.
5. Output pulses may be generated even when the power supply is OFF. Therefore, it is recommended to first turn OFF the power supply for the load or the load line.
6. Do not tighten nuts or screws with excessive force. To secure the Sensor with nuts, use the nuts that are included with the Sensor, and tighten the nuts to a torque of 0.3 to 0.4 N·m (2.0 N·m max.). To secure the Sensor with M3 screws, tighten the screws to a torque of 0.6 N·m max..

E3Z-F

Dimensions

(Unit: mm)

Tolerance class IT16 applies to dimensions in this data sheet unless otherwise specified.

Sensors

Pre-wired

E3Z-FT□1□

E3Z-FR□11

E3Z-FD□1□

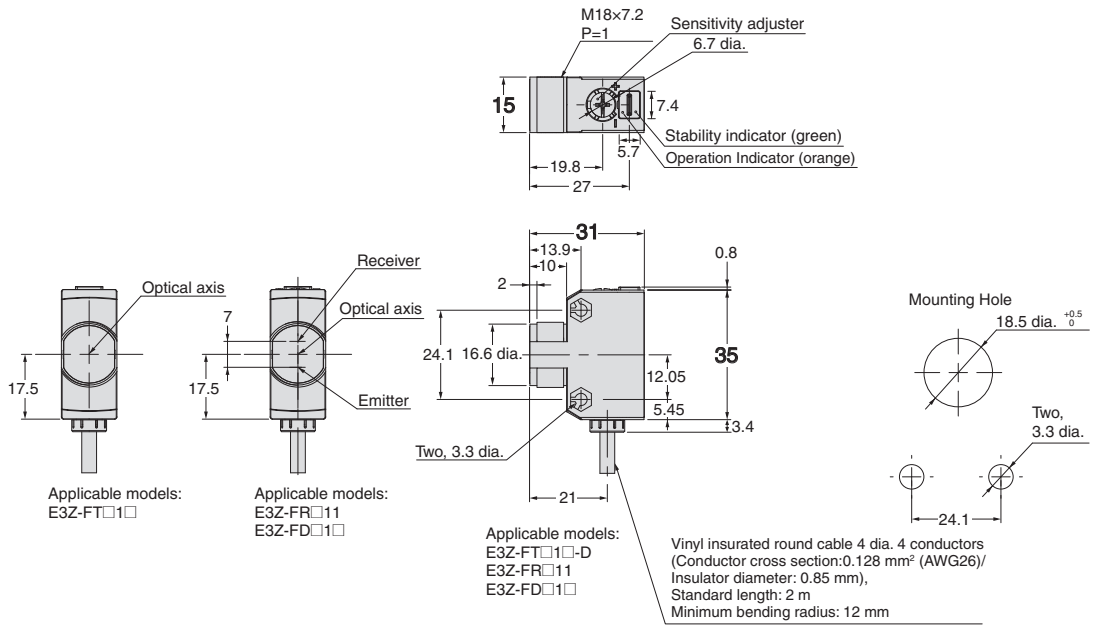

Connector (M12)

E3Z-FT□2□

E3Z-FR□21

E3Z-FD□2□

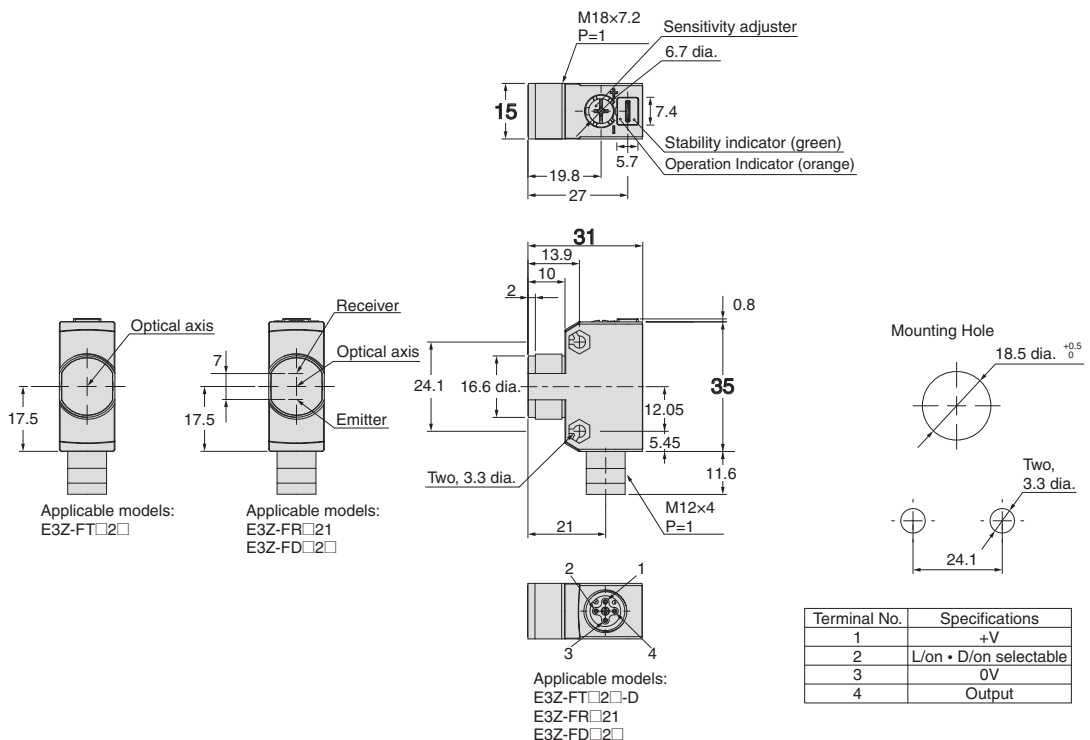

Tightening Nuts

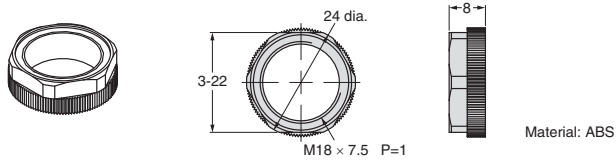

Accessories (Sold Separately)

Reflector
E39-R1S

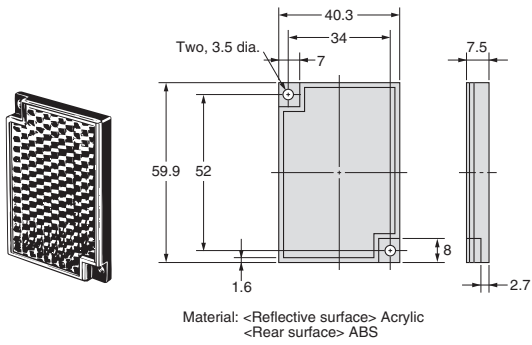

Mounting Brackets
E39-L189

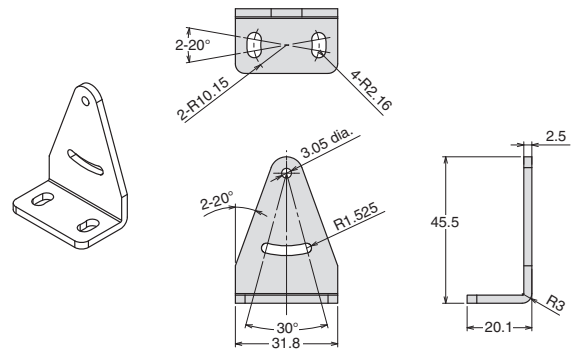

Mounting Brackets
E39-L183

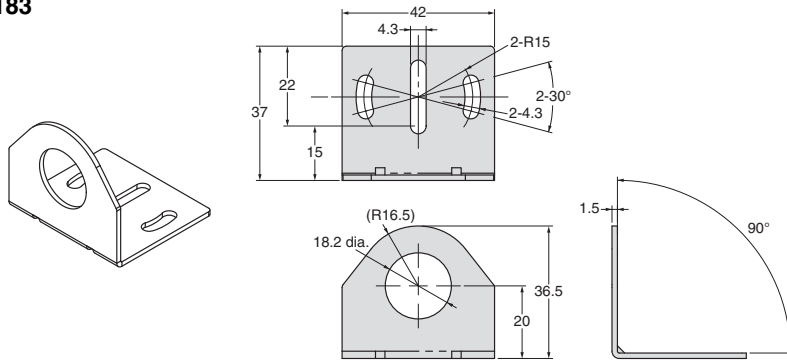

E3Z-F

Compact Photoelectric Sensor with Built-in Amplifier

E3Z

The Standard for Photoelectric Sensors with a Secure Track Record of 1.5 Million Sold Yearly.

- Long sensing distance of 30 m for Through-beam Models, 4 m for Retro-reflective Models, and 1 m for Diffuse-reflective Models.
- Mechanical axis and optical axis offset of less than $\pm 2.5^\circ$ simplifies optical axis adjustment.
- High stability with unique algorithm that prevents interference of external light.



Compact Laser Photoelectric Sensor with Built-in Amplifier

E3Z-LT/LR/LL

Compact and Reliable Laser Photoelectric Sensor

- Safety and reliability with laser class 1 (JIS and IEC).
- Product lineup includes models with distance setting without influence of color.
- Maximum ambient operating temperature of 55°C and waterproof construction (IP67) in E3Z class.



Grooved-type Photoelectric Sensor with Built-in Amplifier

E3Z-G

Photoelectric Sensor with Grooved Design and Easy Settings

- Grooved-type Sensor with groove width of 25 mm.
- Models are available with one or two light axes.
- Models are available with M8 pre-wired connectors.



Compact Photoelectric Sensor with Stainless Steel Housing

E3ZM

Stainless Steel Housing Ideal for Food Industry (SUS316L)

- Strong resistance against detergents, disinfectants, and jet liquid flow.
- Product lineup includes BGS reflective models and through-beam models with built-in slits.
- Certified by Ecolab Europe.



Color Mark Detection Compact Photoelectric Sensor

E3ZM-V

Industry's Smallest Color Mark Sensor

- Excellent space savings.
(Reduced by 90% compared with previous OMRON models.)
- Improved color-difference discrimination with white LED and RGB signal processing.
- Equipped with two types of teaching:
(2-point teaching and automatic teaching.)



Transparent Object (PET Bottle) Detection Compact Photoelectric Sensor

E3ZM-B

Excellent PET Bottle Detection

- New detection method that is independent of bottle shape, position, and contents.
- Automatic compensation against effects of contamination and temperature (except E3ZM-B□T).
- Product lineup includes models with adjuster (E3ZM-B□T).
- Detects transparent objects made by PET, resin, or glass.



Oil-resistant, Robust, Compact Photoelectric Sensor

E3ZM-C

Photoelectric Sensor for the Automotive and Machine Tool Industries

- Oil-resistant, rugged body made of stainless steel.
- Spot visibility improved to as far as 1 m away.
Product lineup includes through-beam models with orange spot.
- Product lineup includes M12 Smartclick pre-wired connector models.



Terms and Conditions of Sale

1. **Offer; Acceptance.** These terms and conditions (these "**Terms**") are deemed part of all quotes, agreements, purchase orders, acknowledgments, price lists, catalogs, manuals, brochures and other documents, whether electronic or in writing, relating to the sale of products or services (collectively, the "**Products**") by Omron Electronics LLC and its subsidiary companies ("**Omron**"). Omron objects to any terms or conditions proposed in Buyer's purchase order or other documents which are inconsistent with, or in addition to, these Terms.
2. **Prices; Payment Terms.** All prices stated are current, subject to change without notice by Omron. Omron reserves the right to increase or decrease prices on any unshipped portions of outstanding orders. Payments for Products are due net 30 days unless otherwise stated in the invoice.
3. **Discounts.** Cash discounts, if any, will apply only on the net amount of invoices sent to Buyer after deducting transportation charges, taxes and duties, and will be allowed only if (i) the invoice is paid according to Omron's payment terms and (ii) Buyer has no past due amounts.
4. **Interest.** Omron, at its option, may charge Buyer 1-1/2% interest per month or the maximum legal rate, whichever is less, on any balance not paid within the stated terms.
5. **Orders.** Omron will accept no order less than \$200 net billing.
6. **Governmental Approvals.** Buyer shall be responsible for, and shall bear all costs involved in, obtaining any government approvals required for the importation or sale of the Products.
7. **Taxes.** All taxes, duties and other governmental charges (other than general real property and income taxes), including any interest or penalties thereon, imposed directly or indirectly on Omron or required to be collected directly or indirectly by Omron for the manufacture, production, sale, delivery, importation, consumption or use of the Products sold hereunder (including customs duties and sales, excise, use, turnover and license taxes) shall be charged to and remitted by Buyer to Omron.
8. **Financial.** If the financial position of Buyer at any time becomes unsatisfactory to Omron, Omron reserves the right to stop shipments or require satisfactory security or payment in advance. If Buyer fails to make payment or otherwise comply with these Terms or any related agreement, Omron may (without liability and in addition to other remedies) cancel any unshipped portion of Products sold hereunder and stop any Products in transit until Buyer pays all amounts, including amounts payable hereunder, whether or not then due, which are owing to it by Buyer. Buyer shall in any event remain liable for all unpaid accounts.
9. **Cancellation; Etc.** Orders are not subject to rescheduling or cancellation unless Buyer indemnifies Omron against all related costs or expenses.
10. **Force Majeure.** Omron shall not be liable for any delay or failure in delivery resulting from causes beyond its control, including earthquakes, fires, floods, strikes or other labor disputes, shortage of labor or materials, accidents to machinery, acts of sabotage, riots, delay in or lack of transportation or the requirements of any government authority.
11. **Shipping; Delivery.** Unless otherwise expressly agreed in writing by Omron:
 - a. Shipments shall be by a carrier selected by Omron; Omron will not drop ship except in "break down" situations.
 - b. Such carrier shall act as the agent of Buyer and delivery to such carrier shall constitute delivery to Buyer;
 - c. All sales and shipments of Products shall be FOB shipping point (unless otherwise stated in writing by Omron), at which point title and risk of loss shall pass from Omron to Buyer; provided that Omron shall retain a security interest in the Products until the full purchase price is paid;
 - d. Delivery and shipping dates are estimates only; and
 - e. Omron will package Products as it deems proper for protection against normal handling and extra charges apply to special conditions.
12. **Claims.** Any claim by Buyer against Omron for shortage or damage to the Products occurring before delivery to the carrier must be presented in writing to Omron within 30 days of receipt of shipment and include the original transportation bill signed by the carrier noting that the carrier received the Products from Omron in the condition claimed.
13. **Warranties.** (a) **Exclusive Warranty.** Omron's exclusive warranty is that the Products will be free from defects in materials and workmanship for a period of twelve months from the date of sale by Omron (or such other period expressed in writing by Omron). Omron disclaims all other warranties, express or implied. (b) **Limitations.** OMRON MAKES NO WARRANTY OR REPRESENTATION, EXPRESS OR IMPLIED, ABOUT NON-INFRINGEMENT, MERCHANTABILITY OR FITNESS FOR A PARTICULAR PURPOSE OF THE PRODUCTS. BUYER ACKNOWLEDGES THAT IT ALONE HAS DETERMINED THAT THE PRODUCTS WILL SUITABLY MEET THE REQUIREMENTS OF THEIR INTENDED USE. Omron further disclaims all warranties and responsibility of any type for claims or expenses based on infringement by the Products or otherwise of any intellectual property right. (c) **Buyer Remedy.** Omron's sole obligation hereunder shall be, at Omron's election, to (i) replace (in the form originally shipped with Buyer responsible for labor charges for removal or replacement thereof) the non-complying Product, (ii) repair the non-complying Product, or (iii) repay or credit Buyer an amount equal to the purchase price of the non-complying Product; provided that in no event shall Omron be responsible for warranty, repair, indemnity or any other claims or expenses regarding the Products unless Omron's analysis confirms that the Products were properly handled, stored, installed and maintained and not subject to contamination, abuse, misuse or inappropriate modification. Return of any Products by Buyer must be approved in writing by Omron before shipment. Omron Companies shall not be liable for the suitability or unsuitability or the results from the use of Products in combination with any electrical or electronic components, circuits, system assemblies or any other materials or substances or environments. Any advice, recommendations or information given orally or in writing, are not to be construed as an amendment or addition to the above warranty. See <http://www.omron247.com> or contact your Omron representative for published information.
14. **Limitation on Liability; Etc.** OMRON COMPANIES SHALL NOT BE LIABLE FOR SPECIAL, INDIRECT, INCIDENTAL, OR CONSEQUENTIAL DAMAGES, LOSS OF PROFITS OR PRODUCTION OR COMMERCIAL LOSS IN ANY WAY CONNECTED WITH THE PRODUCTS, WHETHER SUCH CLAIM IS BASED IN CONTRACT, WARRANTY, NEGLIGENCE OR STRICT LIABILITY. Further, in no event shall liability of Omron Companies exceed the individual price of the Product on which liability is asserted.
15. **Indemnities.** Buyer shall indemnify and hold harmless Omron Companies and their employees from and against all liabilities, losses, claims, costs and expenses (including attorney's fees and expenses) related to any claim, investigation, litigation or proceeding (whether or not Omron is a party) which arises or is alleged to arise from Buyer's acts or omissions under these Terms or in any way with respect to the Products. Without limiting the foregoing, Buyer (at its own expense) shall indemnify and hold harmless Omron and defend or settle any action brought against such Companies to the extent based on a claim that any Product made to Buyer specifications infringed intellectual property rights of another party.
16. **Property; Confidentiality.** Any intellectual property in the Products is the exclusive property of Omron Companies and Buyer shall not attempt to duplicate it in any way without the written permission of Omron. Notwithstanding any charges to Buyer for engineering or tooling, all engineering and tooling shall remain the exclusive property of Omron. All information and materials supplied by Omron to Buyer relating to the Products are confidential and proprietary, and Buyer shall limit distribution thereof to its trusted employees and strictly prevent disclosure to any third party.
17. **Export Controls.** Buyer shall comply with all applicable laws, regulations and licenses regarding (i) export of products or information; (ii) sale of products to "forbidden" or other proscribed persons; and (iii) disclosure to non-citizens of regulated technology or information.
18. **Miscellaneous.** (a) **Waiver.** No failure or delay by Omron in exercising any right and no course of dealing between Buyer and Omron shall operate as a waiver of rights by Omron. (b) **Assignment.** Buyer may not assign its rights hereunder without Omron's written consent. (c) **Law.** These Terms are governed by the law of the jurisdiction of the home office of the Omron company from which Buyer is purchasing the Products (without regard to conflict of law principles). (d) **Amendment.** These Terms constitute the entire agreement between Buyer and Omron relating to the Products, and no provision may be changed or waived unless in writing signed by the parties. (e) **Severability.** If any provision hereof is rendered ineffective or invalid, such provision shall not invalidate any other provision. (f) **Setoff.** Buyer shall have no right to set off any amounts against the amount owing in respect of this invoice. (g) **Definitions.** As used herein, "including" means "including without limitation"; and "Omron Companies" (or similar words) mean Omron Corporation and any direct or indirect subsidiary or affiliate thereof.

Certain Precautions on Specifications and Use

1. **Suitability of Use.** Omron Companies shall not be responsible for conformity with any standards, codes or regulations which apply to the combination of the Product in the Buyer's application or use of the Product. At Buyer's request, Omron will provide applicable third party certification documents identifying ratings and limitations of use which apply to the Product. This information by itself is not sufficient for a complete determination of the suitability of the Product in combination with the end product, machine, system, or other application or use. Buyer shall be solely responsible for determining appropriateness of the particular Product with respect to Buyer's application, product or system. Buyer shall take application responsibility in all cases but the following is a non-exhaustive list of applications for which particular attention must be given: (i) Outdoor use, uses involving potential chemical contamination or electrical interference, or conditions or uses not described in this document. (ii) Use in consumer products or any use in significant quantities. (iii) Energy control systems, combustion systems, railroad systems, aviation systems, medical equipment, amusement machines, vehicles, safety equipment, and installations subject to separate industry or government regulations. (iv) Systems, machines and equipment that could present a risk to life or property. Please know and observe all prohibitions of use applicable to this Product. NEVER USE THE PRODUCT FOR AN APPLICATION INVOLVING SERIOUS RISK TO LIFE OR PROPERTY OR IN LARGE QUANTITIES WITHOUT ENSURING THAT THE SYSTEM AS A WHOLE HAS BEEN DESIGNED TO ADDRESS THE RISKS, AND THAT THE OMRON'S PRODUCT IS PROPERLY RATED AND INSTALLED FOR THE INTENDED USE WITHIN THE OVERALL EQUIPMENT OR SYSTEM.
2. **Programmable Products.** Omron Companies shall not be responsible for the user's programming of a programmable Product, or any consequence thereof.
3. **Performance Data.** Data presented in Omron Company websites, catalogs and other materials is provided as a guide for the user in determining suitability and does not constitute a warranty. It may represent the result of Omron's test conditions, and the user must correlate it to actual application requirements. Actual performance is subject to the Omron's Warranty and Limitations of Liability.
4. **Change in Specifications.** Product specifications and accessories may be changed at any time based on improvements and other reasons. It is our practice to change part numbers when published ratings or features are changed, or when significant construction changes are made. However, some specifications of the Product may be changed without any notice. When in doubt, special part numbers may be assigned to fix or establish key specifications for your application. Please consult with your Omron's representative at any time to confirm actual specifications of purchased Product.
5. **Errors and Omissions.** Information presented by Omron Companies has been checked and is believed to be accurate; however, no responsibility is assumed for clerical, typographical or proofreading errors or omissions.

OMRON AUTOMATION AND SAFETY • THE AMERICAS HEADQUARTERS • Chicago, IL USA • 847.843.7900 • 800.556.6766 • www.omron247.com

OMRON CANADA, INC. • HEAD OFFICE

Toronto, ON, Canada • 416.286.6465 • 866.986.6766 • www.omron247.com

OMRON ELECTRONICS DE MEXICO • HEAD OFFICE

México DF • 52.55.59.01.43.00 • 01-800-226-6766 • mela@omron.com

OMRON ELECTRONICS DE MEXICO • SALES OFFICE

Apodaca, N.L. • 52.81.11.56.99.20 • 01-800-226-6766 • mela@omron.com

OMRON ELETRÔNICA DO BRASIL LTDA • HEAD OFFICE

São Paulo, SP, Brasil • 55.11.2101.6300 • www.omron.com.br

OMRON ARGENTINA • SALES OFFICE

Cono Sur • 54.11.4783.5300

OMRON CHILE • SALES OFFICE

Santiago • 56.9.9917.3920

OTHER OMRON LATIN AMERICA SALES

54.11.4783.5300

OMRON EUROPE B.V. • Wegalaan 67-69, NL-2132 JD, Hoofddorp, The Netherlands. • +31 (0) 23 568 13 00 • www.industrial.omron.eu

Authorized Distributor:

Automation Control Systems

- Machine Automation Controllers (MAC) • Programmable Controllers (PLC)
- Operator interfaces (HMI) • Distributed I/O • Software

Drives & Motion Controls

- Servo & AC Drives • Motion Controllers & Encoders

Temperature & Process Controllers

- Single and Multi-loop Controllers

Sensors & Vision

- Proximity Sensors • Photoelectric Sensors • Fiber-Optic Sensors
- Amplified Photomicrosensors • Measurement Sensors
- Ultrasonic Sensors • Vision Sensors

Industrial Components

- RFID/Code Readers • Relays • Pushbuttons & Indicators
- Limit and Basic Switches • Timers • Counters • Metering Devices
- Power Supplies

Safety

- Laser Scanners • Safety Mats • Edges and Bumpers • Programmable Safety Controllers • Light Curtains • Safety Relays • Safety Interlock Switches