

# A3D

## Lighted Pushbutton Switch (Cylindrical 8-dia.)

### Lighted Pushbutton Switch with Cylindrical 18-mm × 8-dia. Body

- Excellent illumination with even surface brightness.
- Cylindrical body means panel cutouts can be made easily.
- Combines miniature design with excellent operating sensitivity.



RoHS Compliant

Refer to *Safety Precautions for All Pushbutton Switches/Indicators* and *Safety Precautions* on page 8.

### List of Models

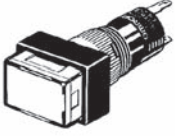
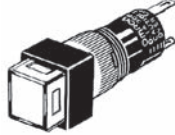
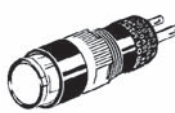
Appearance	Model
Rectangular 	A3DJ
Square 	A3DA
Round 	A3DT

**Model Number Legend** ..... The model numbers used to order sets of Units are illustrated below. One set comprises the Pushbutton (LED lamp built-in) and Switch.  
For information on combinations, refer to *Ordering Information*.

A 3 D <sup>(1)</sup> J - 90 <sup>(2)</sup> A 1 - 00 E <sup>(3)</sup> R

#### (1) Shape of Pushbutton

Symbol	Shape
J	Rectangular
A	Square
T	Round

#### (2) Switch Specifications Microload (30 VDC, 0.1 A)

Symbol	Terminals	Operation	Contact
A	Solder	Momentary	SPST-NO
B		Alternate	

- Minimum applicable load: 1 mA at 5 VDC
- Standard load models are not available.
- If PCB terminals are required, use the Socket given under Accessories on page 3.
- Momentary operation: Self-resetting
- Alternate operation: Self-holding

#### (3) Color of Pushbutton

Symbol	Color
R	Red
Y	Yellow
G	Green
W	White

- All models are illumination only. Colored-illumination models are not available.
- Non-lighted models are not available.
- An external resistor is required. (Refer to page 8.)

■ Specifications: Refer to page 3. ■ Dimensions: Refer to page 6. ■ Accessories: Refer to page 3.  
■ Precautions for correct use and safety precautions: Refer to page 8.

### Ordering Information

**Ordering as a Set** ..... The model numbers used to order sets of Units are given in the following table. One set comprises the Pushbutton (LED lamp built-in), and Switch.

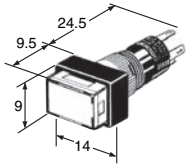
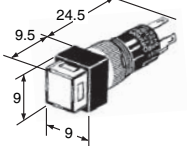
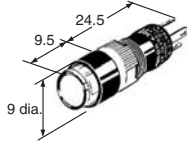
Appearance	Degree of protection	Operation	Model number	Color symbol for Pushbutton	Minimum packing unit
<b>A3DJ (Rectangular)</b> 	IP40	Momentary	<b>A3DJ-90A1-00E</b> □	R, Y, G, W	10 pcs
		Alternate	<b>A3DJ-90B1-00E</b> □		
<b>A3DA (Square)</b> 		Momentary	<b>A3DA-90A1-00E</b> □		
		Alternate	<b>A3DA-90B1-00E</b> □		
<b>A3DT (Round)</b> 		Momentary	<b>A3DT-90A1-00E</b> □		
		Alternate	<b>A3DT-90B1-00E</b> □		

Note: 1. Enter the desired color symbol for the Pushbutton in □.  
 2. All the above are solder-terminal, microload, SPST-NO, LED lamp-lighted models.

**Ordering Individually** ..... Pushbuttons and Switches can be ordered separately. Combinations that are not available as sets can be created using individual Units.

**Ordering: Specify a model number from the following table.**

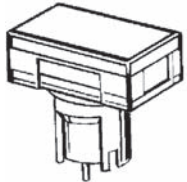
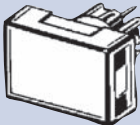
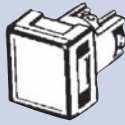
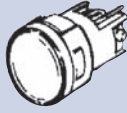
Pushbutton (LED built-in)	Appearance	Rectangular	Square	Round	Minimum packing unit
	Color of pushbutton				10 pcs
	Red	<b>A3DJ-500R</b>	<b>A3DA-500R</b>	<b>A3DT-500R</b>	
	Yellow	<b>A3DJ-500Y</b>	<b>A3DA-500Y</b>	<b>A3DT-500Y</b>	
	Green	<b>A3DJ-500GY</b>	<b>A3DA-500GY</b>	<b>A3DT-500GY</b>	
	White	<b>A3DJ-500W</b>	<b>A3DA-500W</b>	<b>A3DT-500W</b>	

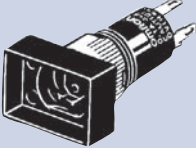
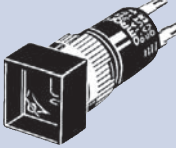
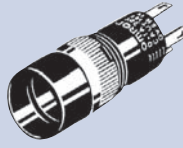

Switch			Sealing Appearance	IP40			Minimum packing unit
Contact type	Operating action	Terminal type	Rectangle	Square	Round		
SPST-NO	Momentary	Solder terminals				10 pcs	
	Alternate	Solder terminals	<b>A3DJ-7121</b>	<b>A3DA-7121</b>	<b>A3DT-7121</b>		



Ordering set combinations: Refer to this page.

■ Specifications: Refer to page 3. ■ Dimensions: Refer to page 6.  
 ■ Accessories: Refer to page 3.

A  
3  
D

### Ordering Information

#### Accessories (Order Separately)

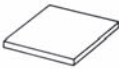
Name	Appearance	Classification	Model	Remarks	Minimum packing unit
Socket		Wire-wrap terminal	A3D-4101	Cannot be used together with Insulation Cover.	100 pcs
		PCB terminal	A3D-4102		
		Solder terminal	A3D-4103		
Insulation Cover		--	A3D-3002	Cannot be used together with the Socket.	
Tightening Tool		--	A3D-3004	Do not tighten to a torque exceeding 0.29 N·m.	10 pcs
Legend Plate		Rectangular	A3DJ-5201	One milky-white Legend Plate is included with standard products.	100 pcs
		Square	A3DA-5201		
		Round	A3DT-5201		

### Specifications

#### Ratings

**Contact Rating: 30 VDC, 0.1 A (Minimum Applicable Load: 5 VDC, 1 mA)**

Note: Minimum allowable load: 5 VDC 1 mA (Resistive)

The ratings given above are for testing under the following conditions:

- (1) Ambient temperature:  $20 \pm 2^\circ\text{C}$
- (2) Ambient humidity:  $65 \pm 5\%\text{RH}$
- (3) Operating frequency: 20 times/minute

#### Built-in LED Lamp

( $T_a=25^\circ\text{C}$ )

Color of LED Lamp		Red	Yellow (White) *2	Green
Forward voltage, $V_F$	Reference value (V) *1	1.7	2.2	2.1
	Maximum value (V)	2.0	2.5	2.5
Forward current, $I_F$	Reference value (mA)	20	20	20
	Absolute maximum value (mA)	50	50	50
Permissible dissipation, PD	Absolute maximum value (mW)	100	125	122
Reverse voltage, $V_R$	Absolute maximum value (V)	4	4	4

Note: The built-in LED lamp has no limiting resistor and so it is necessary to connect an external resistor within the range shown in the above table. (For details of calculation formulas, refer to page 8.)

\*1. Refer to Engineering Data on page 4.

\*2. The same LED lamp is used for both yellow illumination and white illumination and so the ratings are the same.

#### Characteristics

Operating frequency	Mechanical	Momentary operation models: 120 operations/minute max. Alternate operation models: 60 operations/minute max. *1
	Electrical	20 operations/minute max.
Contact resistance (initial value)		100mΩ max.
Insulation resistance		100 MΩ min. (at 500 VDC with insulation tester)
Dielectric strength	Between terminals of same polarity	1,000 VAC, 50/60 Hz for 1 min
	Between terminals of different polarity	2,000 VAC, 50/60 Hz for 1 min
	Between each terminal and ground	2,000 VAC, 50/60 Hz for 1 min
	Between lamp terminals	1,000 VAC, 50/60 Hz for 1 min *2
Vibration resistance	Malfunction	10 to 55 Hz, 1.5 mm double amplitude *3
Shock resistance	Destruction	500 m/s <sup>2</sup> max.
	Malfunction	150 m/s <sup>2</sup> max. *3
Durability	Mechanical	Momentary operation models: 1,000,000 operations min. Alternate operation models: 100,000 operations min. *1
	Electrical	100,000 operations min.
Ambient operating temperature		-10°C to +55°C (with no icing or condensation)
Ambient operating humidity		35% to 85%RH
Ambient storage temperature		-25°C to +65°C (with no icing or condensation)
Degree of protection		IEC IP40
Weight		Approx. 3 g
Electric shock protection class		Class II
PTI (proof tracking index)		175
Pollution degree		3 (IEC60947-5-1)

\*1. With alternate operation models, one operation cycle consists of set and reset operations.

\*2. The figure is for when the LED lamp is not mounted.

\*3. Indicates malfunctions of less than 1 ms.

### Specifications

#### Operating Characteristics

Operating force	OF max.	2.45 N
Release force	RF min.	0.196 N
Total travel	TT	Approx. 3.5 mm
Locktravel alternate *	LTA min.	0.5 mm
Pretravel	PT max.	2.5 mm

\* Alternate operation models only.

#### Contact Form

Contact name	Contact form
SPST-NO	COM ——— NO

### Engineering Data An external resistor is required. (Refer to page 8.)

#### LED Characteristics (VF -IF Characteristics)

##### Red LED

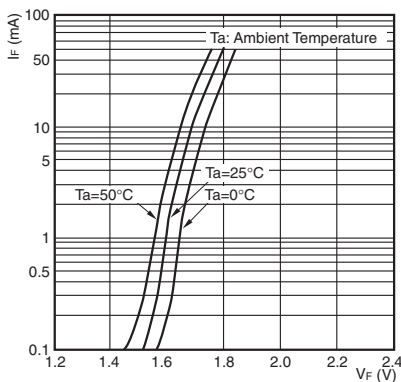

##### Yellow or White LED

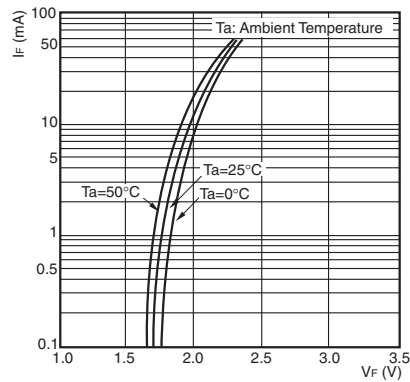

##### Green LED

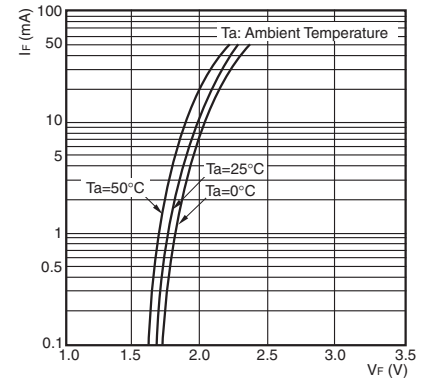

#### Forward Current Reduction Curve

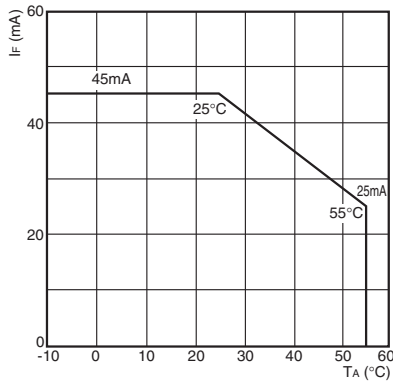

### Nomenclature

### Model Structure

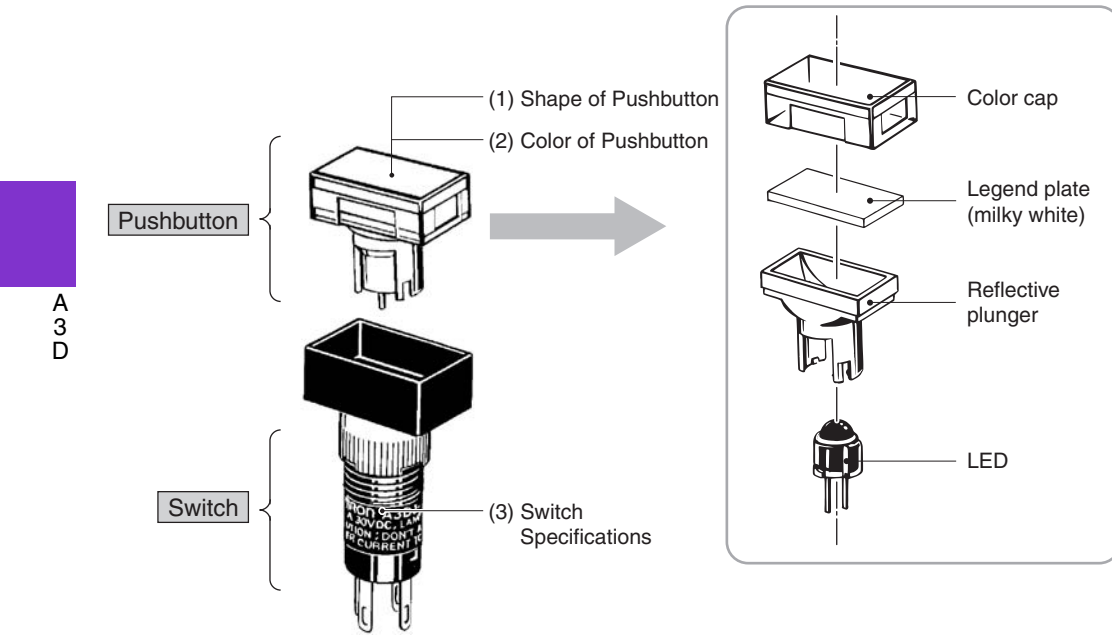

Note: The A3DJ model is shown here as a representative example.

	Type	Specifications
(1)	Shape of Pushbutton Rectangular (A3DJ)    Square (A3DA)    Round (A3DT) 	-----
(2)	LED-lighted Red, Yellow, Green, White	The LED lamp is built into the Pushbutton.
(3)	Microload	0.1 A at 30 VDC (Minimum applicable load: 1 mA at 5 VDC)

# A3D

## Lighted Pushbutton Switch (Cylindrical 8-dia.)

### Dimensions

(Unit: mm)

#### Rectangular Models A3DJ

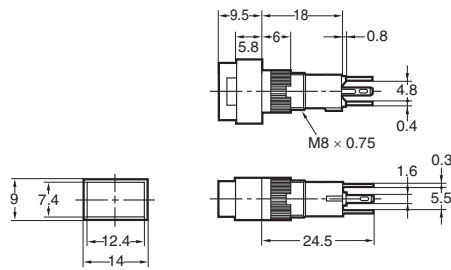
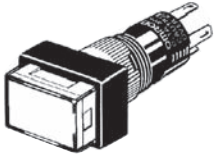

Panel Cutouts  
(TOP VIEW)

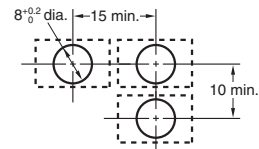

Note: Recommended panel thickness: 1.0 to 3.2 mm.

#### Square Models A3DA

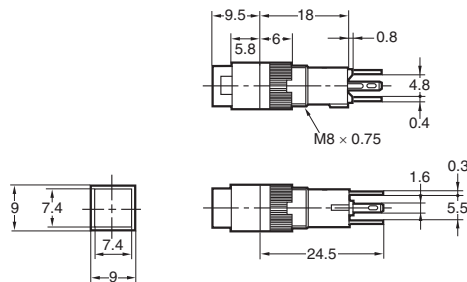
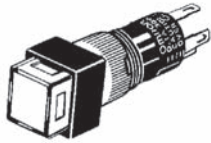

Panel Cutouts  
(TOP VIEW)

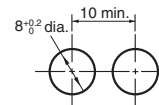

Note: Recommended panel thickness: 1.0 to 3.2 mm.

#### Round Models A3DT

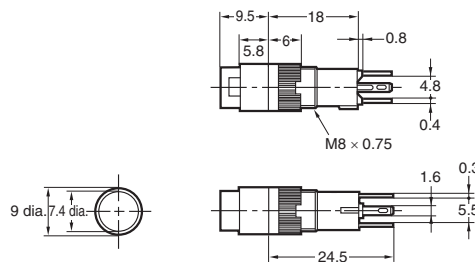
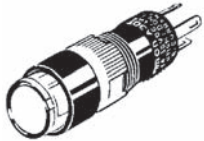

Panel Cutouts  
(TOP VIEW)

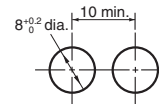

Note: Recommended panel thickness: 1.0 to 3.2 mm.

If the panel is to be finished (e.g., coated), make sure that the panel meets the specified dimensions after the coating.

### Terminals

Terminals	Type	SPST-NO Lighted Models
Solder Terminals		<p>Terminal Arrangement (Bottom View)</p> <p>The diagram shows the terminal arrangement for SPST-NO Lighted Models. It includes a cross-section of the terminal with dimensions: 0.8 mm for the terminal width, 6.5 mm for the terminal height, 10.4 mm for the terminal length, and 0.8 x 2 mm for the terminal opening. The LED terminal is 1.6 mm wide and 0.3 mm high. The terminal arrangement (bottom view) shows a circular terminal with terminals labeled C, L, NO, and L+. A circuit diagram shows the terminal arrangement connected to a switch.</p>

### Dimensions

(Unit: mm)

#### Accessory Mounting Dimensions

#### Socket Mounting Dimensions

##### Wire-wrap Terminal/A3D-4101

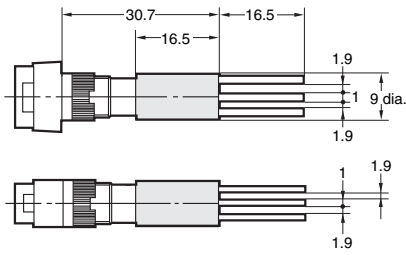

##### PCB Terminal/A3D-4102

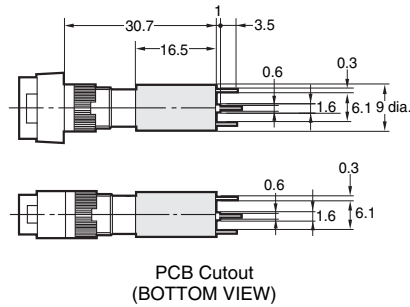

PCB Cutout  
(BOTTOM VIEW)

##### Solder Terminal/A3D-4103

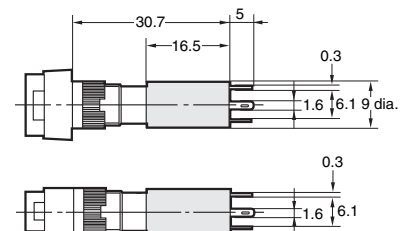

#### Insulation Cover Mounting Dimensions (The illustration shows the rectangular model as a representative example.)

##### A3D-3002

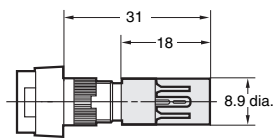

- After securing the Switch to the panel using the mounting nut, pass the lead wires through the holes in the Insulation Cover before performing wiring. Hold the Insulation Cover so that the cylindrical hole is facing the Switch, and insert the lead wires from the end with the barriers.
- After wiring is completed, mount the Insulation Cover by pushing it into the Switch.

Note: Unless specified, there is a tolerance of  $\pm 0.4$  mm for dimensions.

#### Legend Plate Mounting Dimensions

##### Rectangular/A3DJ-5201

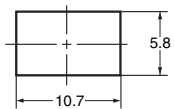

##### Square/A3DA-5201

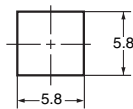

##### Round/A3DT-5201

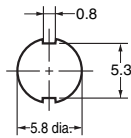

Note: 1. The thickness is 0.8 mm.

2. Since the legend plate is made of polycarbonate, use alcohol-based paints such as melanin, phthalic acid, or acrylic paint when marking the legend.

### Safety Precautions

Refer to *Safety Precautions for All Pushbutton Switches/Indicators*.

#### Precautions for Correct Use

##### Mounting

- Always make sure that the power is turned OFF before mounting, removing, or wiring the Switch, or performing maintenance. Electric shock or fire may occur.
- Do not tighten the mounting ring excessively using pliers or a similar tool. Excessive tightening may damage the mounting ring. (Tightening torque: 0.20 to 0.29 N·m)

##### Wiring

- When wiring, use wires of a size appropriate for the applied voltage and carry current. Perform soldering correctly under the conditions given below. Using the Switch with the wires soldered incorrectly may cause the terminals to become abnormally hot and cause a fire.
1. Hand soldering:  
Soldering iron tip temperature: 350°C max. within 3 seconds.
  2. Dip soldering: At 350°C within 3 seconds.  
Wait for one minute after soldering before exerting any external force on the solder.
- Use a non-corrosive rosin liquid for the flux.
  - Perform wiring so that the wire sheaths do not come into contact with the Switch. If this is unavoidable, use wires that can withstand temperatures of 100°C min.  
After wiring to the Switch has been completed, ensure an appropriate insulation distance.

##### LED

- The polarity of the LED is indicated on the back of the Switch. Wire the LED correctly according to the polarity.
- The built-in LED does not have a limiting resistor. Connect a limiting resistor.
- Make sure that the limiting resistor satisfies the characteristics of the built-in LED. The forward current of the built-in LED must be 8 mA minimum.
- The resistance can be calculated by using the following expression.

$$R = \frac{E - V_F}{I_F} (\Omega)$$

$E$  : Operating voltage (V)  
 $V_F$  : LED forward voltage (V)  
 $I_F$  : LED forward current (A)

##### Recommended Values for Limiting Resistance

Voltage	Red	Yellow (White)	Green
5 VDC	165 Ω	140 Ω	145 Ω
12 VDC	515 Ω	490 Ω	495 Ω
24 VDC	1,100 Ω	1,090 Ω	1,095 Ω

Note: The above values are calculated values that can be used as reference.

##### Calculation Example for Limiting Resistance

LED lamp illuminating color: Red

$E = 24V$

$I_F = 20mA$

$T_a = 25^\circ C$

The VF-IF characteristics (for red) on page 4 yield the following:

$V_F = 1.7 V$  when  $I_F = 20 mA$ .

Therefore, inserting the values into the formula above ( $R = E - V_F / I_F (\Omega)$ ):

$R = 24 (V) - 1.7 (V) / 0.02 (A) \cong 1100 (\Omega)$ .

The recommended resistance is 1.1 kΩ at 1 W ( $2 \times I_F^2 R$ ).

Note: Approximately twice this value is appropriate to provide a margin in the capacity of the resistor.

##### Operating Environment

- Ensure that dust, metal powder, or oil do not enter the interior of the Switch.

##### Using Microloads

- Using a standard load switch for opening and closing a microload circuit may cause wear on the contacts. Use the switch within the operating range. (Refer to the diagram below.) Even when using microload models within the operating range shown below, if inrush current occurs when the contact is opened or closed, it may cause the contact surface to become rough, and so decrease life expectancy. Therefore, insert a contact protection circuit where necessary.

The minimum applicable load is the N-level reference value. This value indicates the malfunction reference level for the reliability level of 60% ( $\lambda 60$ ) (conforming to JIS C5003). The equation,  $\lambda 60 = 0.5 \times 10^{-6} / \text{times}$  indicates that the estimated malfunction rate is less than 1/2,000,000 with a reliability level of 60%.

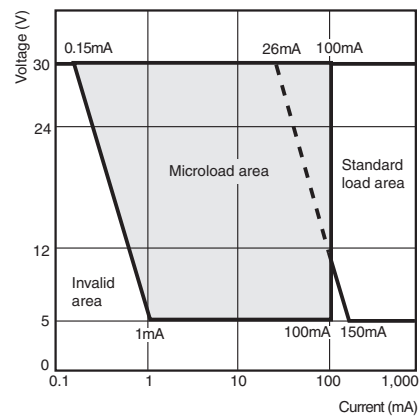



### Application

#### Mounting and Replacing the Pushbutton

(1) Mounting Direction for the Pushbutton and Switch

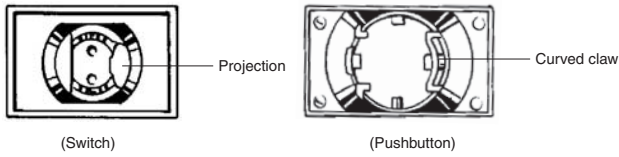

- Align the curved claw on the outside of the protruding part of the Pushbutton with the projection on the upper part of the Switch and insert.
  - Apply a pressure between 9.8 and 24.5 N.
  - If the terminals of the LED lamp become bent, it may be impossible to fit them into the LED lamp terminal holes. Ensure that the terminals are straight when they are inserted.
- Be sure to insert the lamp terminals for round models (A3DT or M2DT) with the correct orientation. Inserting the terminals with the reverse orientation will result in damage.

(2) Removing the Pushbutton

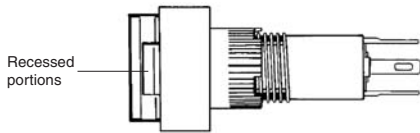

- Hold the recessed portions on the cap of the Pushbutton and pull.
- Do not use tools such as pliers to remove the Pushbutton as this may damage the cap.

### Panel Mounting

#### Using the Mounting Nut

- Insert the Switch from the front of the panel. Mount the mounting nut from the terminal end of the Switch and tighten it.
- Tighten the nut to a torque 0.20 to 0.29 N·m.
- If soldering is used, mount the mounting nut first. Lead wires and mounds of solder may make it impossible to mount the nut after soldering.

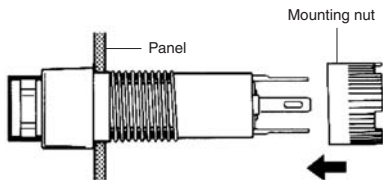

### Socket Mounting

- After securing the Switch to the panel using the mounting nut, insert the Socket into the Switch.
- When inserting the Socket, align the positioning groove of the Socket with the projecting part of the Switch.

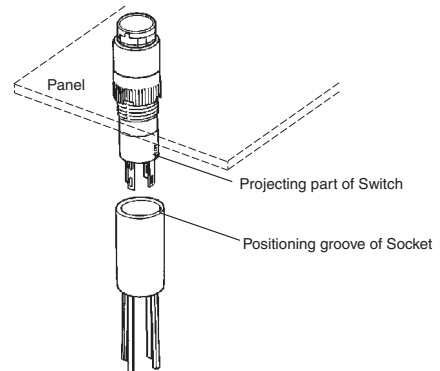

- Application examples provided in this document are for reference only. In actual applications, confirm equipment functions and safety before using the product.
- Consult your OMRON representative before using the product under conditions which are not described in the manual or applying the product to nuclear control systems, railroad systems, aviation systems, vehicles, combustion systems, medical equipment, amusement machines, safety equipment, and other systems or equipment that may have a serious influence on lives and property if used improperly. Make sure that the ratings and performance characteristics of the product provide a margin of safety for the system or equipment, and be sure to provide the system or equipment with double safety mechanisms.

**Note: Do not use this document to operate the Unit.**