

Power Relays G7Z

Multi-pole Power Relay for Carrying and Switching Contactor Current Range of 40 A at 440 VAC

- 40 A can be carried and switched on each of 4 poles.
- Possible to reach a maximum load capacity of 160 A when using 4-pole parallel connections.
- EN 60947-4-1 certification for mirror contact mechanisms has been obtained by using a combination of the relay and auxiliary contact blocks.
- Typical applications: high current or high inrush power supplies, commercial and industrial.
- RoHS compliant.

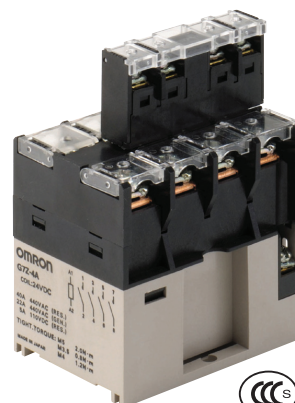

Model Number Structure

Model Number Legend

Relay with Auxiliary Contact Block

G7Z- \square - \square \square DC \square
1 2 3 4

1. Relay Contact Configuration

- 4A: 4PST-NO
- 3A1B: 3PST-NO/SPST-NC
- 2A2B: DPST-NO/DPST-NC

2. Contact Configuration of Auxiliary Contacts

- 20: DPST-NO
- 11: SPST-NO/SPST-NC
- 02: DPST-NC

3. Contact Mechanism of Auxiliary Contacts

- Z: Bifurcated crossbar contact

4. Contact Mechanism of Auxiliary Contacts

- 12: 12 VDC
- 24: 24 VDC

Auxiliary Contact Block

G73Z- \square \square
1 2

1. Contact Configuration of Auxiliary Contacts

- 20: DPST-NO
- 11: SPST-NO/SPST-NC
- 02: DPST-NC

2. Contact Mechanism of Auxiliary Contacts

- Z: Bifurcated crossbar contact

Ordering Information

| Classification | Structure | Contact configuration | | Screw terminals (See notes 1 and 2) |
|------------------------------------|-------------------|-----------------------|-------------------------|--|
| | | Relay | Auxiliary Contact Block | |
| Relay with Auxiliary Contact Block | 4 poles + 2 poles | 4PST-NO | DPST-NO | G7Z-4A-20Z |
| | | | SPST-NO/SPST-NC | G7Z-4A-11Z |
| | | | DPST-NC | G7Z-4A-02Z |
| | | 3PST-NO/SPST-NC | DPST-NO | G7Z-3A1B-20Z |
| | | | SPST-NO/SPST-NC | G7Z-3A1B-11Z |
| | | | DPST-NC | G7Z-3A1B-02Z |
| | | DPST-NO/DPST-NC | DPST-NO | G7Z-2A2B-20Z |
| | | | SPST-NO/SPST-NC | G7Z-2A2B-11Z |
| | | | DPST-NC | G7Z-2A2B-02Z |
| Auxiliary Contact Block | 2 poles | — | DPST-NO | G73Z-20Z |
| | | | SPST-NO/SPST-NC | G73Z-11Z |
| | | | DPST-NC | G73Z-02Z |

- Note:**
1. Relay contact terminals are M5, and the coil terminals are M3.5.
 2. Auxiliary contact block terminals are M3.5.
 3. To Order: Select the part number and add the desired coil voltage rating (e.g., G7Z-4A-20Z DC12)

Specifications

■ Ratings

Coil Ratings

| Rated voltage | Item | Rated current | Coil resistance | Must operate voltage | Must release voltage | Maximum voltage | Power consumption |
|---------------|------|---------------|-----------------|----------------------|----------------------|-----------------|-------------------|
| | | | | | | | |
| 12 VDC | | 308 mA | 39 Ω | 75% max. | 10% min. | 110% | Approx. 3.7 W |
| 24 VDC | | 154 mA | 156 Ω | | | | |

- Note:**
1. Rated current and coil resistance were measured at a coil temperature of 23°C with coil resistance of ±15%.
 2. Operating characteristics were measured at a coil temperature of 23°C.
 3. The maximum allowable voltage is the maximum value of the fluctuation range for the Relay coil operating power supply and was measured at an ambient temperature of 23°C. There is, however, no continuous allowance.

Contact Ratings

Relay

| Item | Model | G7Z-4A-□Z, G7Z-3A1B-□Z, G7Z-2A2B-□Z | | |
|----------------------------|-------|-------------------------------------|---------------------------|---------------------------|
| | | Resistive load | Inductive load cosφ = 0.3 | Resistive load L/R = 1 ms |
| Contact structure | | Double break | | |
| Contact material | | Ag alloy | | |
| Rated load | NO | 40 A at 440 VAC | 22 A at 440 VAC | 5 A at 110 VDC |
| | NC | 25 A at 440 VAC | 10 A at 440 VAC | 5 A at 110 VDC |
| Rated carry current | NO | 40 A | | |
| | NC | 25 A | | |
| Maximum contact voltage | | 480 VAC | | 125 VDC |
| Maximum contact current | NO | 40 A | 22 A | 5 A |
| | NC | 25 A | 10 A | 5 A |
| Maximum switching capacity | NO | 17,600 VA | 9,680 VA | 550 W |
| | NC | 11,000 VA | 4,400 VA | 550 W |
| Minimum load | | 2 A at 24 VDC | | |

Auxiliary Contact Block

| Item | Model | G73Z-20Z, G73Z-11Z, G73Z-02Z | | |
|----------------------------|-------|------------------------------|---------------------------|---------------------------|
| | | Resistive load | Inductive load cosφ = 0.3 | Resistive load L/R = 1 ms |
| Contact structure | | Double break | | |
| Contact material | | Au clad + Ag | | |
| Rated load | | 1 A at 440 VAC | 0.5 A at 440 VAC | 0.5 A at 110 VDC |
| Rated carry current | | 1 A | | |
| Maximum contact voltage | | 480 VAC | | 125 VDC |
| Maximum contact current | | 1 A | | |
| Maximum switching capacity | | 440 VA | 220 VA | 55 W |
| Minimum load | | 1 mA at 5 VDC | | |

Note: The ratings for the auxiliary contact block mounted on the G7Z are the same as those for the G73Z auxiliary contact block.

■ Characteristics

| Item | Classification Model | Relay (See note 6.) | Auxiliary contact block |
|-------------------------------------|--|---|------------------------------|
| | | G7Z-4A-□Z, G7Z-3A1B-□Z, G7Z-2A2B-□Z | G73Z-20Z, G73Z-11Z, G73Z-02Z |
| Contact resistance (See note 2.) | | 400 mΩ max. | 100 mΩ max. |
| Operating time (See note 3.) | | 50 ms max. | |
| Release time (See note 3.) | | 50 ms max. | |
| Maximum operating frequency | Mechanical | 1,800 operations/h | |
| | Rated load | 1,200 operations/h | |
| Insulation resistance (See note 4.) | | 1,000 MΩ min. | |
| Dielectric strength | Between coil and contacts | 4,000 VAC, 50/60 Hz for 1 min | — |
| | Between contacts of different polarity | 4,000 VAC, 50/60 Hz for 1 min | |
| | Between contacts of the same polarity | 2,000 VAC, 50/60 Hz for 1 min | |
| Impulse withstand voltage | Between coil and contacts | 10 kV, 1.2 x 50 μs | — |
| | Between contacts of different polarity | 10 kV, 1.2 x 50 μs | |
| | Between contacts of the same polarity | 4.5 kV, 1.2 x 50 μs | |
| Vibration resistance | Destruction | 10 to 55 to 10 Hz, 0.5-mm single amplitude (1.0-mm double amplitude) | |
| | Malfunction | NO: 10 to 55 to 10 Hz, 0.5-mm single amplitude (1.0-mm double amplitude) NC: 10 to 32 to 10 Hz, 0.5-mm single amplitude (1.0-mm double amplitude) | |
| Shock resistance | Destruction | Screw mounting: 800 m/s ² , DIN Track mounting: 500 m/s ² | |
| | Malfunction | NO: 100 m/s ² NO: 25 m/s ² | |
| Endurance | Mechanical | 1,000,000 operations min. (at 1,800 operations/h, contact no load) | |
| | Electrical (See note 5.) | AC resistive load: 80,000 operations AC inductive load: 80,000 operations DC resistive load: 100,000 operations (at 1,200 operations/h, rated load) | |
| Minimum load (@ 1,800 operations/h) | | 2 A at 24 VDC | 1 mA at 5 VDC |
| Ambient operating temperature | | -25 to 60°C (with no icing or condensation) | |
| Ambient operating humidity | | 5% to 85% | |
| Weight | | Approx. 330 g | Approx. 18 g |

Note: 1. The above values are initial values.

- The contact resistance for the Relay (G7Z) was measured with 1 A at 5 VDC using the voltage drop method. The contact resistance for the auxiliary contact block (G73Z) was measured with 0.1 A at 5 VDC using the voltage drop method.
- The operate time was measured with the rated voltage imposed with any contact bounce ignored at the ambient temperature of 23°C.
- The insulation resistance was measured with a 1,000-VDC megohmmeter applied to the same places as those used for checking the dielectric strength.
- The electrical endurance was measured at an ambient temperature of 23°C.
- The specifications for the auxiliary contact block mounted on the G7Z are the same as those for the G73Z auxiliary contact block.

■ Approved Standards

UL Recognized (File No. E41643) -- Ambient Temp = 40°C

| Model | Coil ratings | Contact ratings | Number of test operations | |
|-------|--------------|-----------------|---|---------|
| G7Z | 12, 24 VDC | NO contact | 40 A, 480 VAC, 60 Hz (Resistive) | 80,000 |
| | | | 5 A, 120 VDC (Resistive) | 100,000 |
| | | | 22 A, 480 VAC, 60 Hz (General Use) | 100,000 |
| | | | D300* (1-A current applied) | — |
| | | NC contact | 25 A, 480 VAC, 60 Hz (Resistive) | 100,000 |
| | | | 5 A, 120 VDC (Resistive) 10 A, 480 VAC, 60 Hz (General Use) D300* (1-A current applied) | — |

*Auxiliary contact ratings

| Model | Contact ratings |
|-------|-----------------|
| G73Z | NO contact |
| | NC contact |

CSA Certification by 
 CCC Certification (File No. 2009010304361493)
 GB14048.4 

EN Standard/TÜV Certification: EN 60947-4-1
 (Certification No. R50079155) 

| Model | Coil ratings | Contact ratings | |
|-------|--------------|-----------------|--|
| G7Z | 12, 24 VDC | NO contact | AC-1: 40 A, 440 V, 50/60 Hz |
| | | | AC-3: 16 A, 440 V, 50/60 Hz |
| | | | DC-1: 5 A, 110 V |
| | | | *AC-15: 0.5 A, 440 V, 50/60 Hz *DC-13: 0.5 A, 110 V |
| | | NC contact | AC-1: 25 A, 440 V, 50/60 Hz |
| | | | DC-1: 5 A, 110 V |
| | | | *AC-15: 0.5 A, 440 V, 50/60 Hz |
| | | | *DC-13: 0.5 A, 110 V |
| G73Z | — | NO contact | AC-15: 0.5 A, 440 V, 50/60 Hz |
| | | NC contact | DC-13: 0.5 A, 110 V |

*Auxiliary contact ratings

Connections

Terminal Arrangement/Internal Connections

Relay with Auxiliary Contact Block

Note: non-polarized coil.

G7Z-4A-20Z

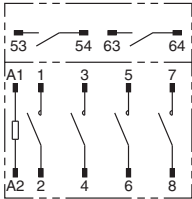

G7Z-4A-11Z

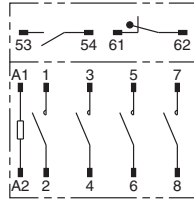

G7Z-4A-02Z

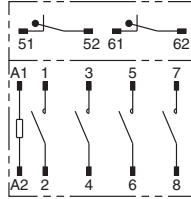

G7Z-3A1B-20Z

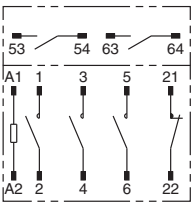

G7Z-3A1B-11Z

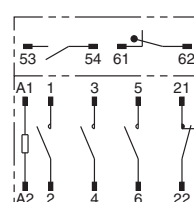

G7Z-3A1B-02Z

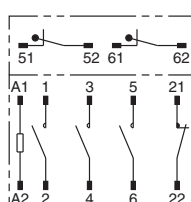

G7Z-2A2B-20Z

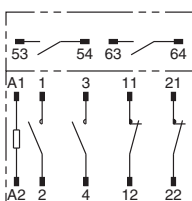

G7Z-2A2B-11Z

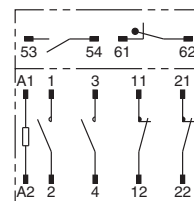

G7Z-2A2B-02Z

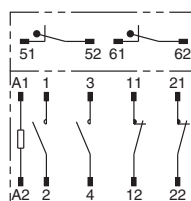

Auxiliary Contact Block

G73Z-20Z

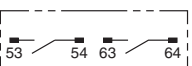

G73Z-11Z

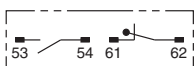

G73Z-02Z

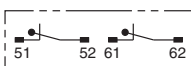

Dimensions

Note: All units are in millimeters unless otherwise indicated.

Relay (12 VDC, 24 VDC) with Auxiliary Contact Block

4 Poles

Mounting Hole Dimensions

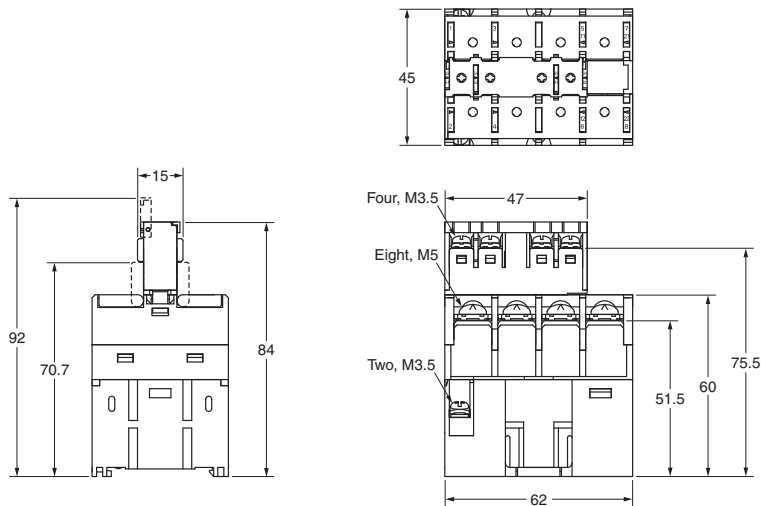
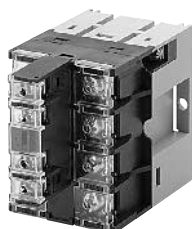

Note: The dimensions are typical values.

Auxiliary Contact Block

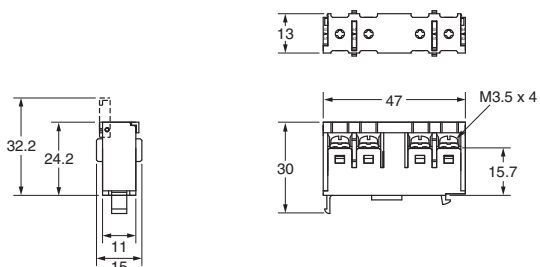

Note: The dimensions are typical values.

DIN Track Mounting Height

(when using the PFP-100N or PFP-50N mounting rail)

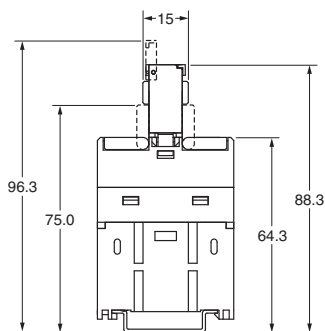

Note: The dimensions are typical values.

Precautions

Be sure to read the common precautions provided in the Technical User's Guide, "Electromechanical Relays, Technical Information" for correct use.

⚠ WARNING

Take measures to prevent contact with charged parts when using the Relay for high voltages.



⚠ CAUTION

Do not touch the terminal section (charged parts) when power is being supplied. Always use the Relay with terminal covers mounted. Contact with charged parts may result in electric shock.



Do not touch the Relay when power is being supplied or right after the power has been turned OFF. The hot surface may cause burn injury.



- Mount the Relay sideways when it is mounted on a rail.
- Use End Plates (PFP-M) on both sides of the Relay to make sure that it is properly secured.

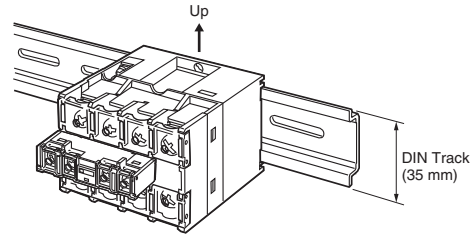

- Provide at least 5 mm of space between the sides and top of the Relay and nearby grounded metal surfaces.

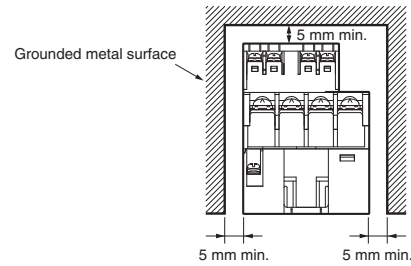

- Provide at least 30 mm of space between Relays when two or more Relays are mounted in a row.

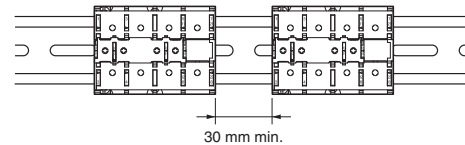

- The auxiliary contact block (G73Z) can be mounted on the Relay.

Mounting and Removal

Mounting

Insert the tab on the auxiliary contact block into the groove on the Relay and press down until the hook on the auxiliary contact block catches in the mounting hole on the Relay.

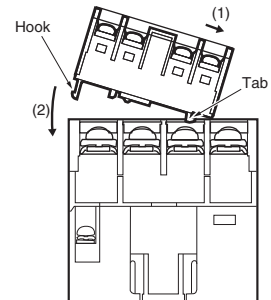

Removing

Slide the auxiliary contact block, remove the auxiliary contact block tab from the groove on the Relay, and remove the auxiliary contact block hook from the Relay.

Be careful not to apply excessive force on the hook.

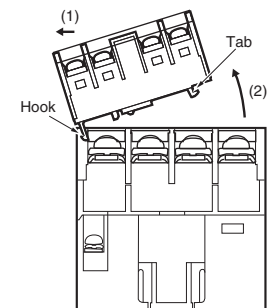

■ Precautions for Correct Use Installation

- Mount the G7Z with the coil terminal at the top.

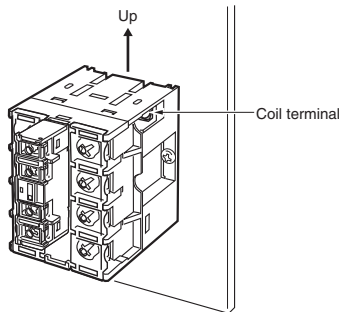

- Do not use the Relay with the terminal screw surfaces facing down.

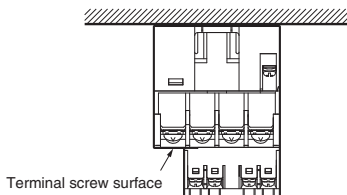

- To mount the Relay, secure M4 screws in two locations. Use a screw-tightening torque of 1.2 to 1.3 N•m.

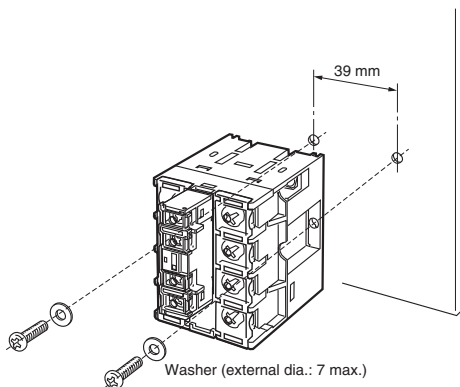

- The Relay can be mounted directly on a mounting rail (PFP) or a DIN Track (EN 50022-35 x 7.5, 15). The Relay cannot be mounted, however, to some reinforced rails (e.g., those produced by Kameda Denki or Toyogiken).

Connecting

- Use round or open-end (Y-type) crimp terminals and connect the terminals with the appropriate tightening torque. Refer to the terminal section space in the following figure for the crimp terminal dimensions.

Relay Contacts (Unit: mm)

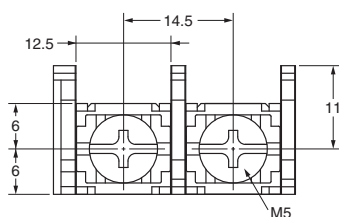

Relay Coil

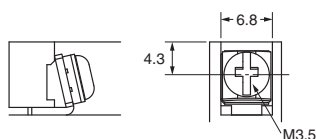

Auxiliary Contact Block

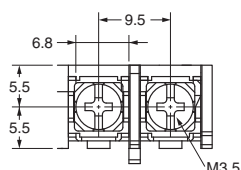

- One crimp terminal can be used for the Relay contact section (M5 screw). Two crimp terminals can be connected for the coil terminal and auxiliary contact block.

Recommended Crimp Terminals and Wire

| Location | Crimp terminals | Appropriate wire size |
|-----------------|-----------------|---|
| Contact section | 5.5-5 | 2.63 to 6.64 mm ² (AWG12, 10) |
| | 8-5 | 6.64 to 10.52 mm ² (AWG8) |
| Coil section | 1.25-3.5 | 0.5 to 1.65 mm ² (AWG20 to 16) |

- Use the following tightening torque when tightening screws. Loose screws may result in fire caused by abnormal heat generated when the power is being supplied.
M5 screws: 2.0 to 2.2 N•m
M3.5 screws: 0.8 to 0.9 N•m
- Allow suitable slack on leads when wiring, and do not subject the terminals to excessive force.

Microloads

The G7Z is used for switching power loads, such as current carry for device power supplies and heater loads. Use an auxiliary contact block (G73Z) if microloads are required for signal applications and operation status feedback.

Operating Coil

(Internal Connections of Coils)

DC Coil

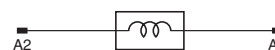

- If a transistor drives the G7Z, check the leakage current and connect a bleeder resistor if necessary.
- The must operate voltage is the minimum value for the Relay armature to operate and the contacts to turn ON. Therefore, fundamentally apply the rated voltage to the coils, taking into consideration the increases in coil resistance caused by voltage fluctuation and coil temperature rise.

Mirror Contact Mechanism

By combining a Relay with an auxiliary contact block, all NC contacts of the auxiliary contact block will satisfy an impulse withstand voltage of more than 2.5 kV or maintain a gap of more than 0.5 mm when the coil is de-energized even if at least one NO contact (main contact) of the Relay is welded (according to EN 60947-4-1).

Description of Mirror Contact Mechanism

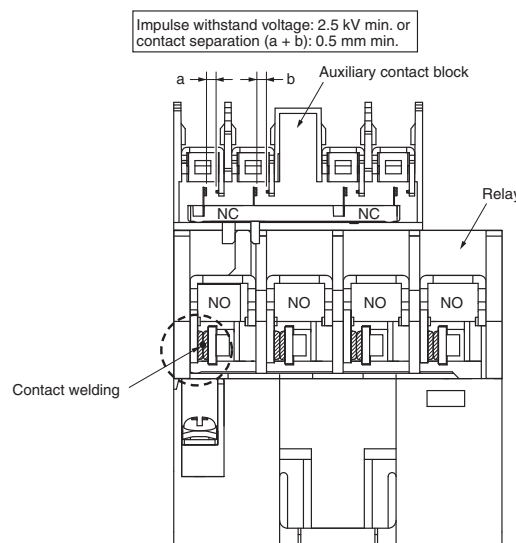

All sales are subject to Omron Electronic Components LLC standard terms and conditions of sale, which can be found at http://www.components.omron.com/components/web/webfiles.nsf/sales_terms.html

ALL DIMENSIONS SHOWN ARE IN MILLIMETERS.
To convert millimeters into inches, multiply by 0.03937. To convert grams into ounces, multiply by 0.03527.

OMRON[®]

**OMRON ELECTRONIC
COMPONENTS LLC**

55 E. Commerce Drive, Suite B
Schaumburg, IL 60173

847-882-2288

OMRON ON-LINE

Global - <http://www.omron.com>

USA - <http://www.components.omron.com>

Cat. No. X301-E-1b

09/11

Specifications subject to change without notice

Printed in USA