

# OMRON

## Enabling Grip Switch

### A4EG

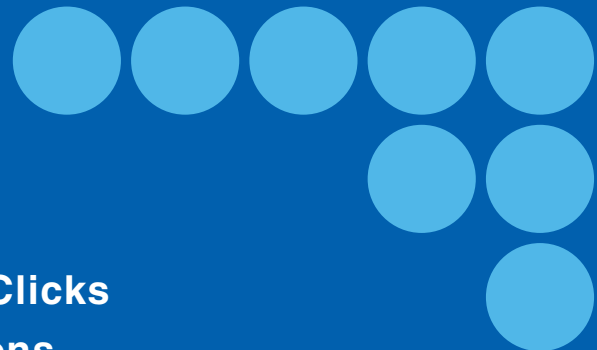

Enabling Grip Switch with Distinct Clicks  
for Three Easily Discernable Positions



realizing

A4EG-C000041

A4EG-BE2R041

A4EG-BM2B041

Equipped with an  
Emergency Stop Switch

Equipped with a  
Momentary Operation Switch

# Helps Ensure Safety during Maintenance

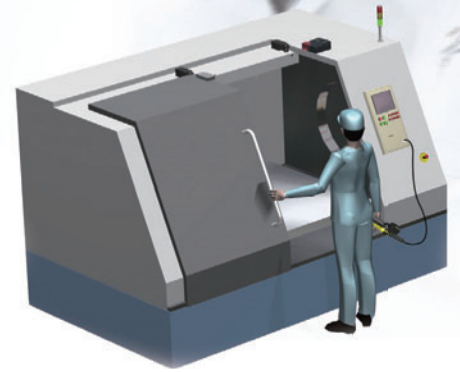

Enabling grip switches are safety components used to prevent unexpected machine operation when workers perform maintenance or other non-routine tasks inside hazardous areas, such as areas inside protective shields.

For more information, refer to the Safety Components Series Catalog (Cat. No. Y106).

## Positive Operating Feel

Original Double Snap Action switch mechanism lets the operator precisely confirm the enable position.

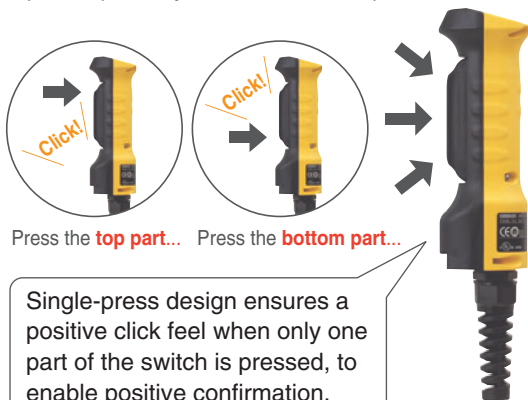

## Safety Circuits Are Easy to Configure

Safety circuits can be easily configured by combining the A4EG with the G9SX-GS Safety Guard Switching Unit.

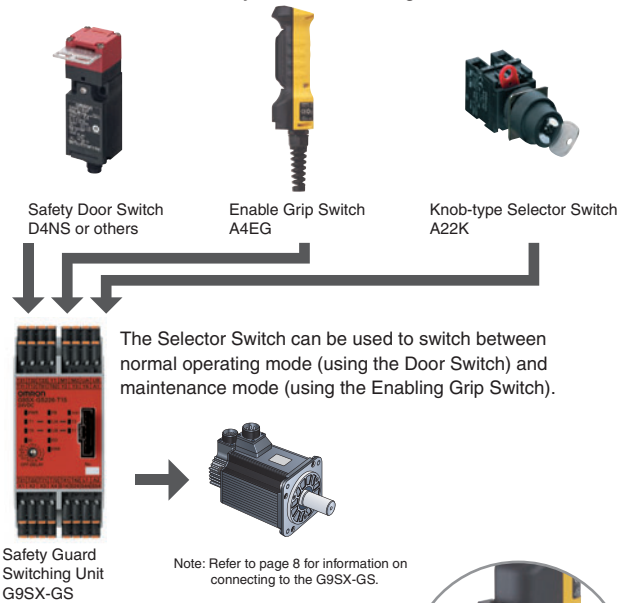

## Selection Based on Application

In addition to the standard models, the lineup also includes models with an emergency stop switch and models with a momentary operation switch.



A holding key can be used to change modes rather than a key-type selector switch.



# Enabling Grip Switch A4EG

## Enabling Grip Switch with Distinct Feel for Three Easily Discernible Positions



- The difficult task of configuring safety circuits is now easily achieved by combining the A4EG with the G9SX-GS.
- In addition to the standard models, the lineup also includes models with an emergency stop switch and models with a momentary operation switch.
- An optional Holding Key (sold separately) provides a versatile method for selecting modes.
- Equipped with conduit connector.





 Be sure to read the "Safety Precautions" on page 12.

## Ordering Information

### Enabling Grip Switches

Appearance	Contact form			Model
	Enabling switch	Monitor switch	Pushbutton switch	
	Two contacts	1NC (grip output)	None	<b>A4EG-C000041</b>
	Two contacts	None	Emergency stop switch (2NC)	<b>A4EG-BE2R041</b>
	Two contacts	None	Momentary operation switch (2NO)	<b>A4EG-BM2B041</b>

### Accessories (Order Separately)

Appearance	Item	Model
	Rubber Cover (replacement part)	<b>A4EG-OP1</b>
	Mounting Bracket (for securing the A4EG)	<b>A4EG-OP2</b>
	Holding Key	<b>A4EG-OP3</b>

# A4EG

## Specifications

### Standards and EC Directives

#### Compliance with EC Directives and International Standards

- Low Voltage Directive
- GS-ET-22

#### Certified Standards

Certifying body	Standard	File No.
TÜV SÜD	EN 60947-5-1 (certified direct opening)	Ask your OMRON representative.
UL *	UL 508, CSA C22.2 No.14	E76675
CQC (CCC)	GB 14048.5	2008010305297698
KOSHA	EN60947-5-1	2008-115

\* Certification for CSA C22.2 No. 14 by UL is indicated by the .

### Certified Standard Ratings (Enabling Switch Section)

#### TÜV (EN 60947-5-1)

Item	Utilization category	AC-15	DC-13
Rated operating current (Ie)		0.75 A	0.55 A
Rated operating voltage (Ue)		240 V	125 V

**Note:** Use a 10-A fuse type gI or gG that conforms to IEC 60269 as the short-circuit protection device. The fuse is not built into the Switch.

#### UL/CSA (UL 508, CSA C22.2 No.14), CCC (GB 14048.5)

- 24 VDC, 0.3 A (inductive load)
- 125 VAC, 1 A (resistive load)

### Ratings

Item	Section	Enabling switch	Emergency stop switch (A4EG-BE2R041 only)	Pushbutton (A4EG-BM2B041 only)
Rated insulation voltage		250 V		---
Rated ON current		2.5 A	5 A	0.1 A
Rated load		24 VDC, 0.3 A (inductive load) 125 VAC, 1 A (resistive load)  EN certification rating: AC-15 0.75 A/240 V DC-13 0.55 A/125 V	General rating: 125 VAC, 5 A (resistive load) 250 VAC, 3 A (resistive load) 30 VDC, 3 A (resistive load)  UL and cUL rating: 125 VAC, 5A (inductive load, power factor: 0.75 to 0.8) 250 VAC, 3 A (inductive load, power factor: 0.75 to 0.8) 30 VDC, 3 A (resistive load)  EN certification rating: AC-12 3 A/250 V DC-12 3 A/30 V	General rating: 125 VAC, 0.1 A (resistive load) 8 VDC, 0.1 A (resistive load) 14 VDC, 0.1 A (resistive load) 30 VDC, 0.1 A (resistive load)  UL and cUL rating: 125 VAC, 0.1 A (resistive load) 30 VDC, 0.1 A (resistive load)  EN certification rating: AC-12 0.1 A/125 V DC-12 0.1 A/30 V
Minimum applicable load		24 VDC, 4 mA		5 VDC, 1 mA

## Characteristics

Item	Section	Enabling switch	Emergency stop switch (A4EG-BE2R041 only)	Pushbutton (A4EG-BM2B041 only)
<b>Degree of protection</b>		IP66 (A4EG-C000041), IP65 (A4EG-BE2R041, A4EG-BM2B041)		
<b>Operating section strength</b>		Operating direction: 200 N, 1 min	Operating direction: 367 N, 1 min Rotating direction: 0.49 N·m, 1 min	Operating direction: 50 N, 1 min
<b>Cable pull strength</b>		30 N, 1 min		
<b>Allowable operating frequency</b>	<b>Electrical</b>	20 operations/minute max.	10 operations/minute max. (set/reset for one operation)	60 operations/minute max.
	<b>Mechanical</b>	20 operations/minute max.	10 operations/minute max. (set/reset for one operation)	120 operations/minute max.
<b>Electrical durability</b>		100,000 operations min. (rated load)	100,000 operations min. (set/reset for one operation) (rated load)	100,000 operations min. (rated load)
<b>Mechanical durability</b>		OFF-ON-OFF (direct opening): 100,000 operations min. OFF-ON: 1,000,000 operations min.	100,000 operations min. (set/reset for one operation)	2,000,000 operations min.
<b>Dielectric strength</b>	<b>Between terminals of the same polarity</b>	2,500 VAC, 50/60 Hz, 1 minute (impulse voltage)	1,000 VAC, 50/60 Hz, 1 minute	1,000 VAC, 50/60 Hz, 1 minute
	<b>Between terminals of the different polarity</b>	2,500 VAC, 50/60 Hz, 1 minute (impulse voltage)	2,000 VAC, 50/60 Hz, 1 minute	2,000 VAC, 50/60 Hz, 1 minute
	<b>Between each terminal and non-current carrying metallic parts</b>	2,500 VAC, 50/60 Hz, 1 minute (impulse voltage)	2,000 VAC, 50/60 Hz, 1 minute	2,000 VAC, 50/60 Hz, 1 minute
<b>Insulation resistance</b>		100 MΩ min. (at 500 VDC)		
<b>Vibration resistance</b>	<b>Malfunction</b>	1.5 mm double amplitude, 10 to 55 Hz		
<b>Shock resistance</b>	<b>Malfunction</b>	150 m/s <sup>2</sup> max.		
<b>Ambient operating temperature</b>		-10 to 55°C (with no icing or condensation)		
<b>Ambient operating humidity</b>		35% to 85%		
<b>Ambient storage temperature</b>		-25 to 65°C (with no icing or condensation)		
<b>Protection against electric shock</b>		Class II (double insulation)		
<b>Pollution degree (operating environment)</b>		3 (EN 60947-5-1)		
<b>Conditional short-circuit current</b>		100 A (EN 60947-5-1)		

**Note:** The timing of contact outputs for two or more circuits is not synchronized. Confirm performance before application.

# A4EG

## Structure and Nomenclature

### Structure

A4EG-C000041

A4EG-BE2R041  
A4EG-BM2B041

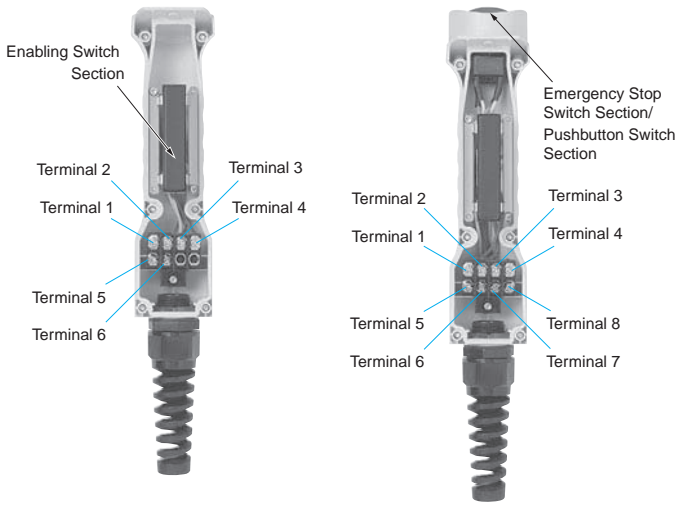

### Three Positions: OFF - ON - OFF

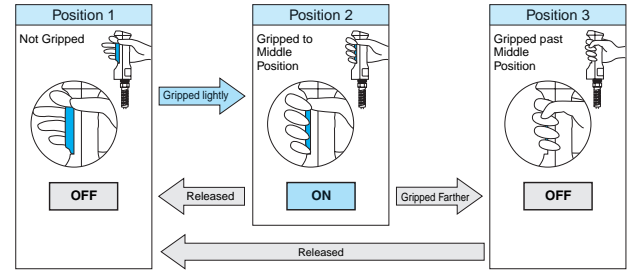

### Contact Configuration

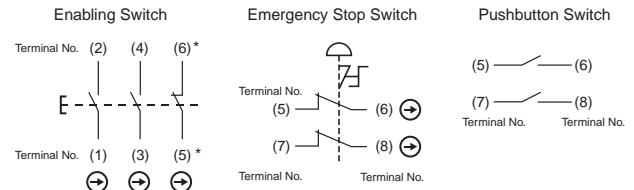

\* Terminal No. (5), (6): A4EG-C000041 only

## Contact Forms

### Operating Patterns

A4EG-C000041

Operation	Terminal No.	Position 1	Position 2	Position 3
Enable output	1 to 2		■	○
	3 to 4		■	○
Grip output	5 to 6	■		○

A4EG-BE2R041

Operation	Terminal No.	Position 1	Position 2	Position 3
Enable output	1 to 2		■	○
	3 to 4		■	○

Pushbutton switch	Terminal No.	Operation	Contact
Emergency stop switch output	5 to 6	Operation (push)	ON → OFF
	7 to 8	Reset (turn reset)	OFF → ON

A4EG-BM2B041

Operation	Terminal No.	Position 1	Position 2	Position 3
Enable output	1 to 2		■	○
	3 to 4		■	○

Pushbutton switch	Terminal No.	Operation	Contact
Pushbutton switch output	5 to 6 (pushbutton switch A) *	Push	OFF → ON
	7 to 8 (pushbutton switch B) *	Push	OFF → ON

\* Refer to *Dimensions* on page 7 for information on the positions of pushbutton switches A and B.

□ OPEN ON: CLOSED  
■ CLOSED OFF: OPEN

**Note:** 1. The contact ON/OFF timing is not synchronized. Confirm performance before application.  
2. Direct opening only during grip.

## Operating Characteristics

### Chart (Enabling Switch Section)

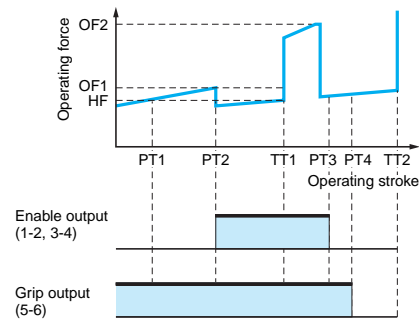

### Operating Stroke (Enabling Switch Section)

Operating characteristics	Specified value
Enable output (ON)	PT2 max. 3.6 mm
Max. enable holding position	TT1 Approx. 4.2 mm
Enable direct opening position	PT3 max. 6.0 mm
Max. stroke	TT2 Approx. 6.7 mm

### Operating Force (Enabling Switch Section: Reference Values)

Operating characteristics	Specified value
Enable operating force	OF1 max. 14 N
Enable holding force	HF * Approx. 8 N
Grip operating force	OF2 max. 40 N

\* HF: Holding force

### Operating Force (Emergency Stop Switch Section: Reference Values)

Operating characteristics	Specified value
Operating force	OF max. 14.7 N
Reset force	RF max. 0.1 N·m

### Operating Force (Pushbutton Switch Section: Reference Value)

Operating characteristics	Specified value
Operating force	OF max. 4 N



# Dimensions

## Enabling Grip Switches

A4EG-C000041

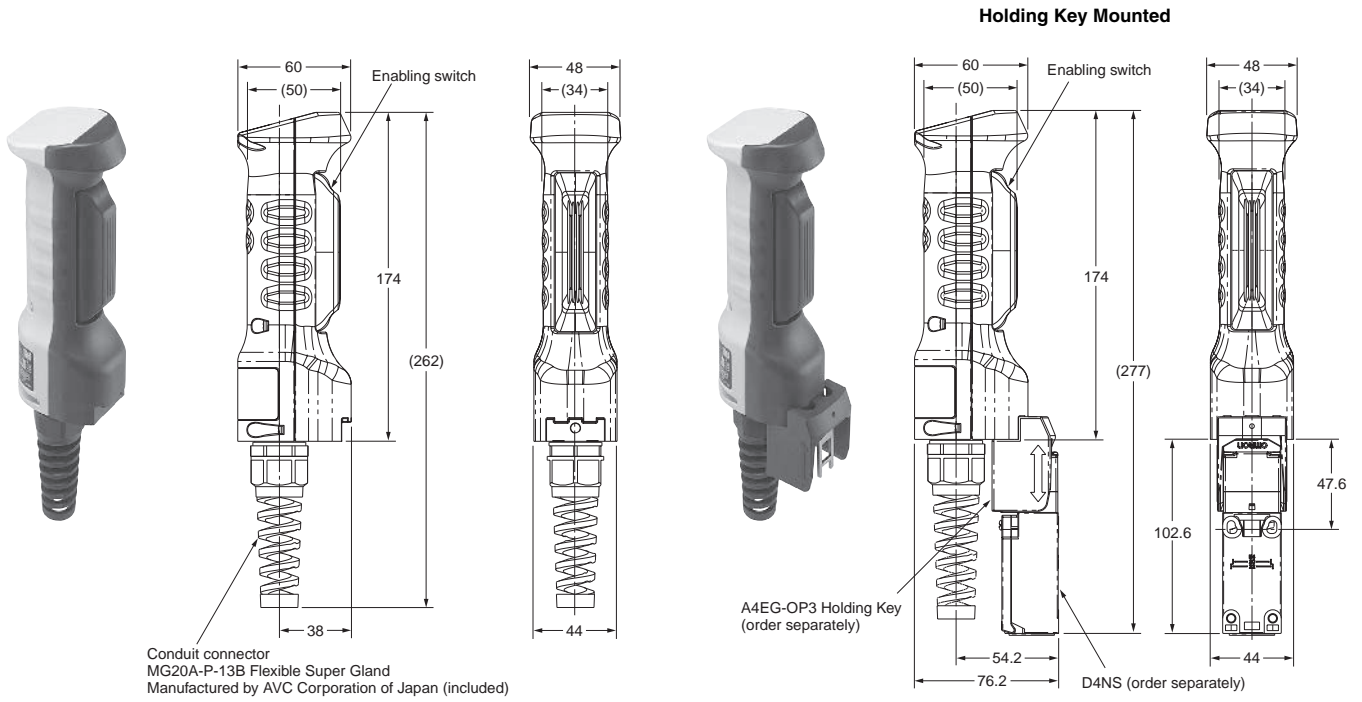

A4EG-BE2R041

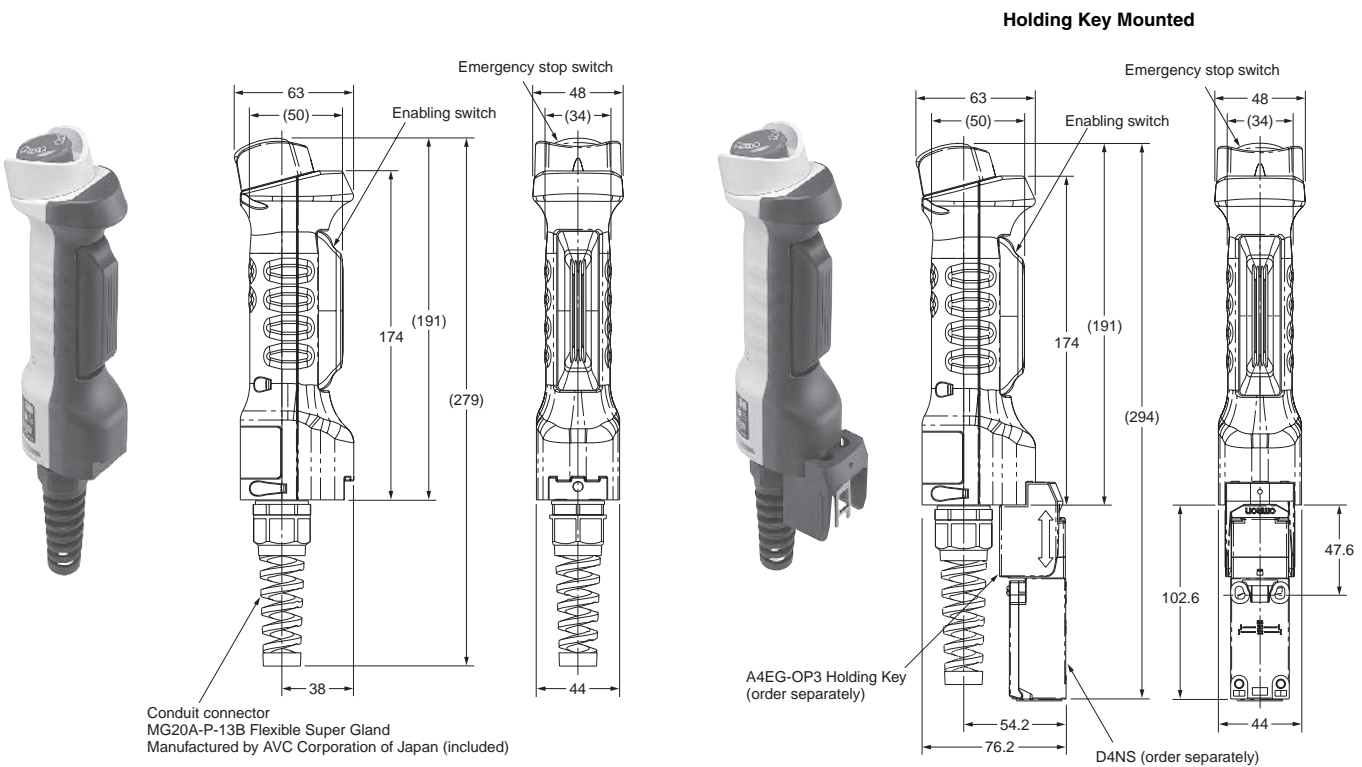

# A4EG

## A4EG-BM2B041

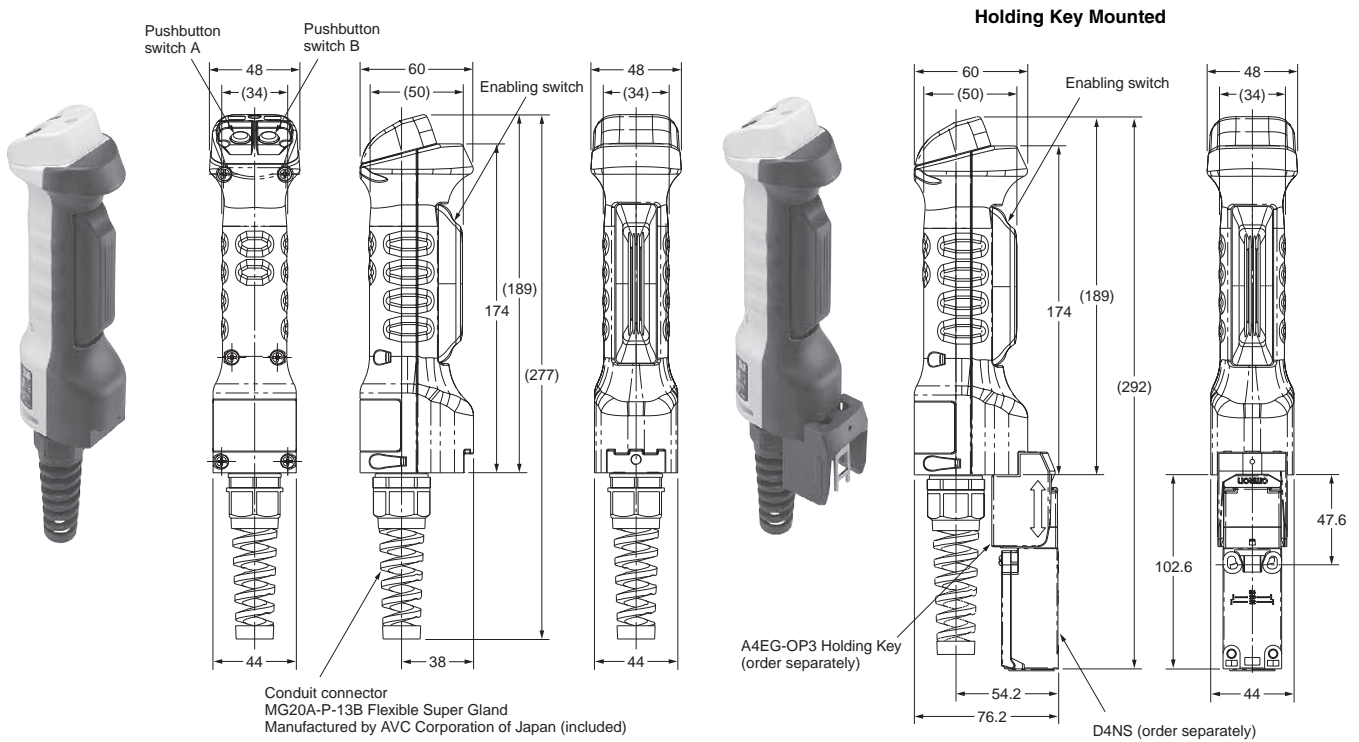

## Accessories (Order Separately)

### Rubber Cover (Replacement Part)

A4EG-OP1



### Mounting Bracket (for Securing the A4EG)

A4EG-OP2

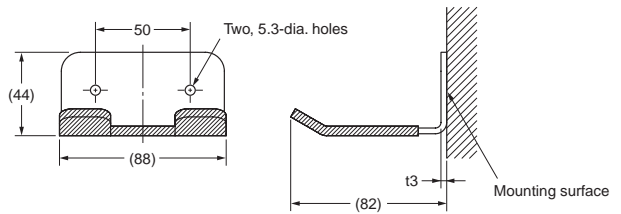

### Enabling Grip Switch Mounted

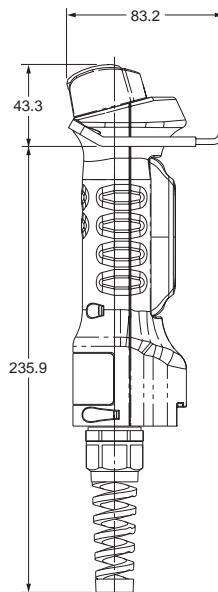

**Note:** The screws are not included.



# Application Examples

## Application Examples

### Machining Equipment Maintenance Mode

- Switching between normal operation mode and maintenance mode is performed manually.
- In normal operation mode, the Safety Door Switch is enabled, and in maintenance mode, the Enabling Grip Switch is enabled.

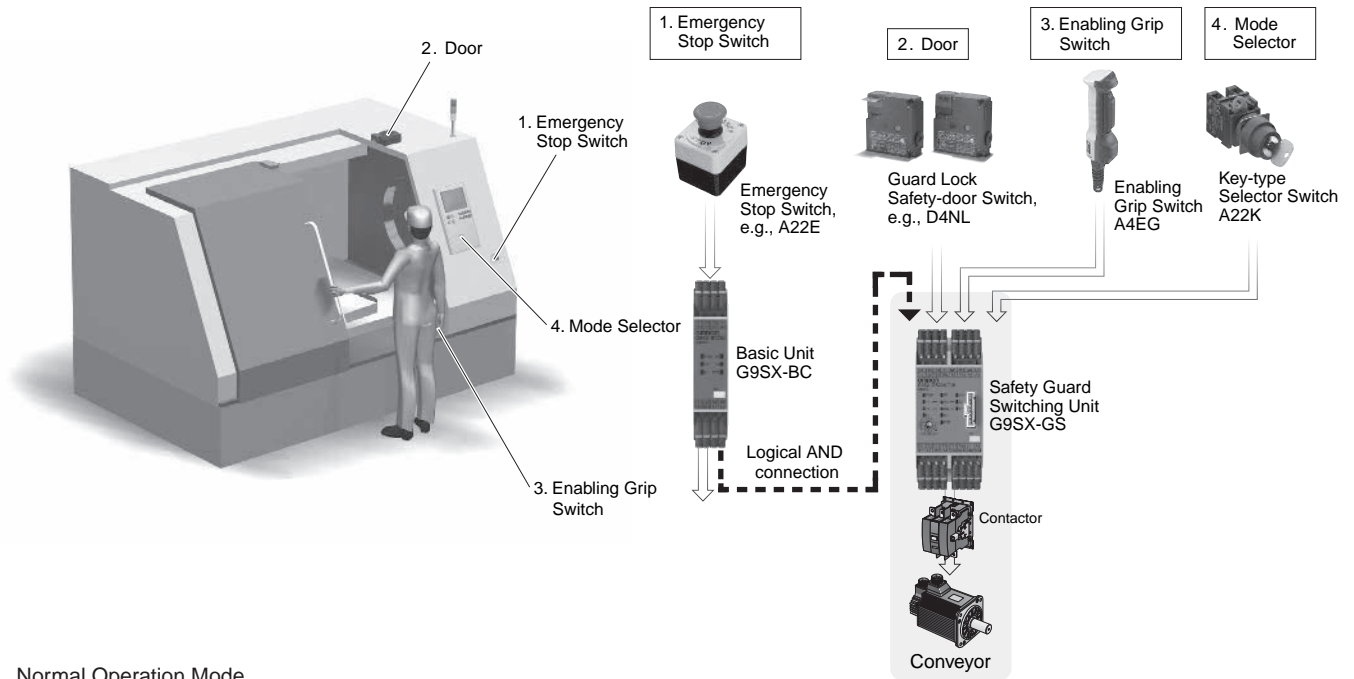

#### Normal Operation Mode

- Emergency Stop Switch** — When pressed, processing will stop.
- Door** — When the door is opened, processing will stop.
- Enabling Grip Switch** — The Enabling Grip Switch will be disabled.

#### Maintenance Mode

- Emergency Stop Switch** — When pressed, processing will stop.
- Door** — The Door Switch will be disabled.
- Enabling Grip Switch** — Processing will be possible only when the operator is gripping the Enabling Grip Switch.

**Note:** For information on the G9SX-GS, refer to *Safety Components Series Catalog* (Cat. No. Y106) and *G9SX User's Guide* (Cat. No. Z255).

## Wiring Example

PL/safety category	Model	Stop category	Reset
PLe/4 equivalent	Safety Key Selector Switch A22TK-2□□-11 (SPST-NO/SPST-NC type) Guard lock Safety-door Switch D4NL-□□A□□-□, -□□□B□□, -□□□□□ (Mechanical Lock Type) Enabling Grip Switch A4EG Safety Guard Switching Unit G9SX-GS226-T15 Flexible Safety Unit G9SX-BC202 (24 VDC)	-	-

- Note:**
- The above PL is only the evaluation result of the example. The PL must be evaluated in an actual application by the customer after confirming the usage conditions.
  - The above PL is the evaluation result concerning the mode selection. The PL for enabling function, guard, emergency stop switch, and other safety functions must be separately evaluated.

### Application Overview

- Switching between normal operation mode and maintenance mode is performed manually.
- In normal operation mode, the power supply to the motor M2 is turned OFF when the guard is opened.
- In maintenance mode, the power supply to the motor M2 is turned OFF when the enabling switch is released or strongly gripped.
- In normal operation mode and maintenance mode, the power supply to the motor M1 and M2 is turned OFF when the emergency stop switch is pressed.

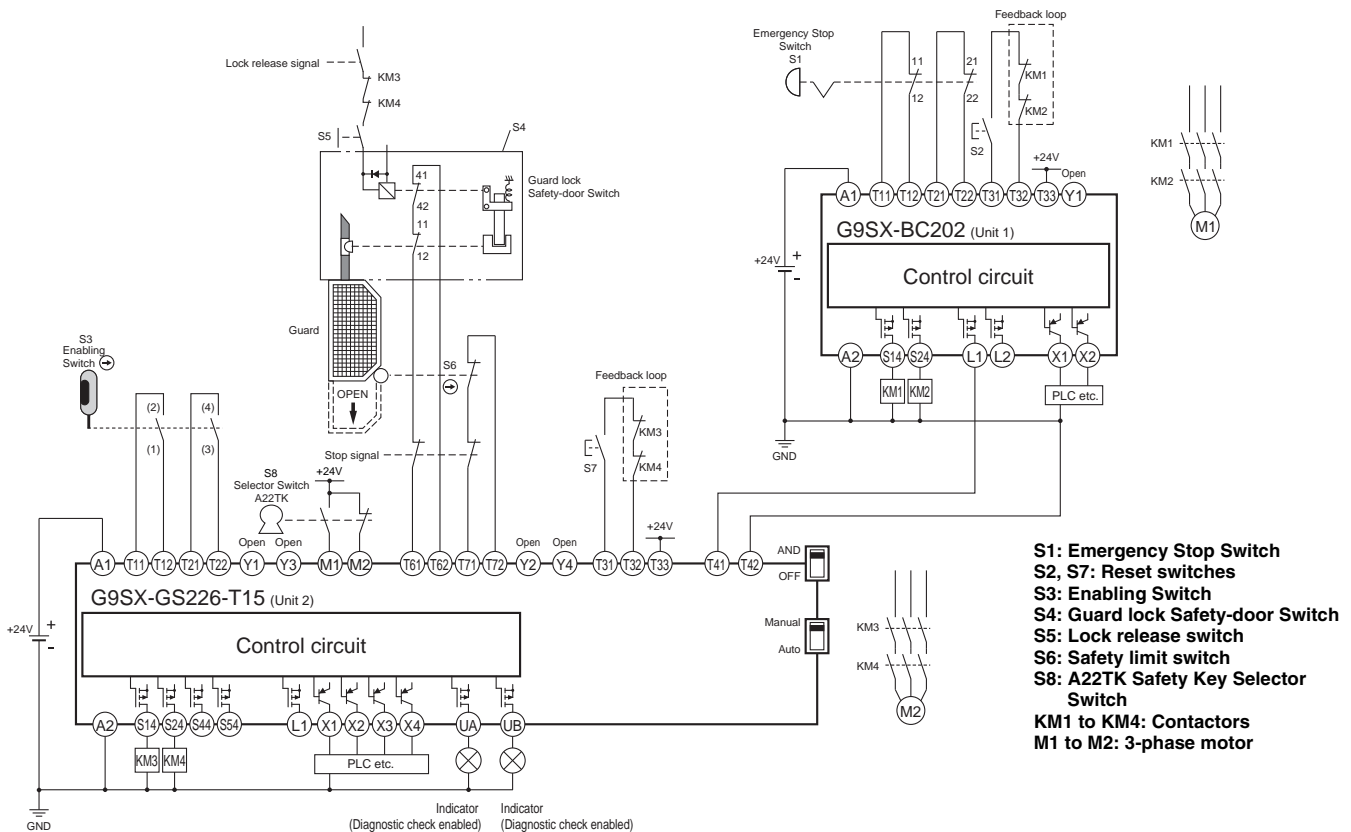

### Timing Chart

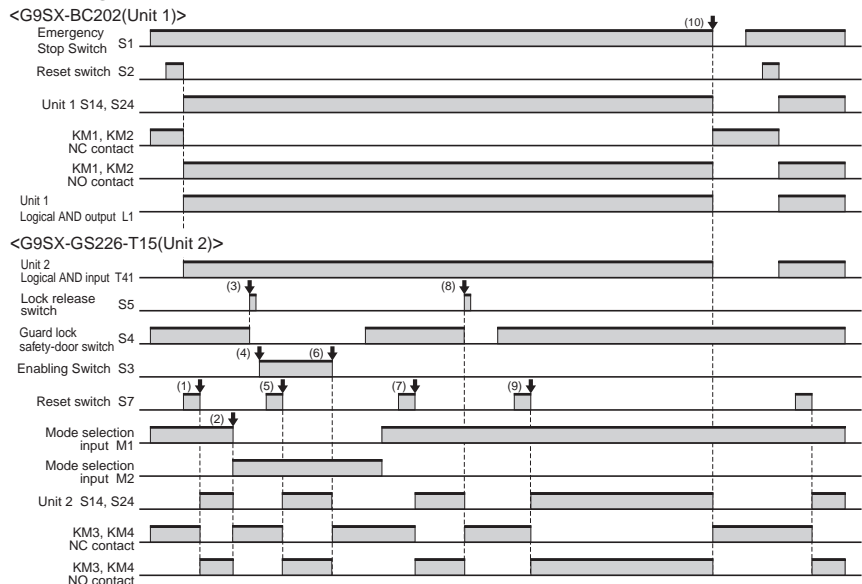

- The G9SX-GS starts in operation mode.
- The mode switches to maintenance mode.
- The operator opens the guard and performs maintenance work.
- The Enabling Switch is gripped to the middle position.
- The G9SX-GS starts in maintenance mode.
- The G9SX-GS will stop when the Enabling Switch is released or gripped.
- The G9SX-GS will start again after the guard is closed and the mode is switched to operation mode.
- The G9SX-GS will stop and the guard can be opened when the stop signal is input while in operation mode.
- The guard is closed and the G9SX-GS starts again.
- All the units will stop if the emergency stop is pressed.

# Safety Precautions

## ⚠ WARNING

Always verify the operation of the safety functions before starting the system. Not doing so may result in the safety functions not performing as expected if the wiring or settings are incorrect or the switches have failed.



Do not drop the switch. Doing so may damage the switch and the system may continue to operate, possibly causing injury or death.



### Precautions for Safe Use

- This product is a switch for teaching the machine such as robot in hazardous area. The machine is allowed to operate only when operating the switch continuously. Configure the system so that the machine can be operated only at position 2.
- Apply load current not to exceed the rated value.
- Do not use the switch submerged in oil or water or in locations continuously subject to splashes of oil or water. Doing so may result in oil or water entering the switch.
- Do not use the switch in locations where explosive or flammable gasses may be present.
- Mount the switch securely to prevent it from falling. Otherwise, injuries may occur.
- The durability of the switch is greatly influenced by the switching conditions. Always test the switch under actual conditions before application and use it in a switching circuit for which there are no problems with performance.
- Always attach the cover after completing wiring and before using the switch. Electric shock may occur if the switch is used without the cover attached.
- The user must not maintain or repair equipment incorporating the switch. Contact the manufacturer of the equipment for any maintenance or repairs required.
- Do not disassemble or remodel the switch in any case, or the switch will not operate normally.
- Do not override by inserting the Holding Key itself in the door switch.
- Configure the circuit so that the machine does not operate when operating the Enabling Switch while the Holding Key is being inserted in the door switch.
- Do not impose excessive vibration or shock on the Door Switch while the Holding Key is inserted. Excessive vibration or shock may cause the Switch to fail or break.
- Do not incline and pull the switch body or do not impose shock on the switch body in the directions shown with the arrows in Fig.1. Otherwise, the switch may be damaged and may not operate properly.
- Refer to the *D4NS Safety-door Switch Datasheet and Instruction Sheet* about the storage, ambient conditions, the details and handling of the Switch.

Fig. 1

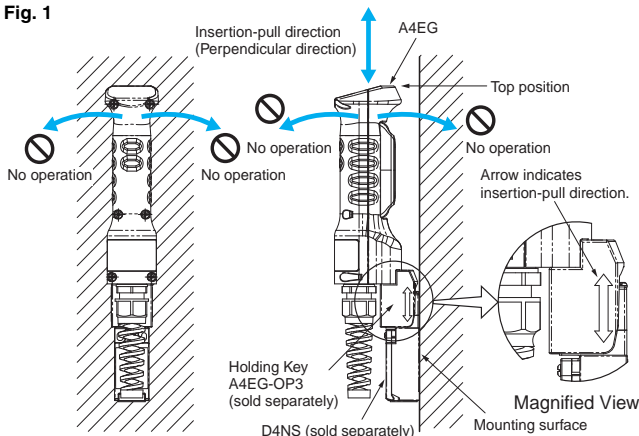

- Do not contact the enabling switch section to the mounting bracket in Fig.2. Doing so may result in malfunction.

Fig. 2

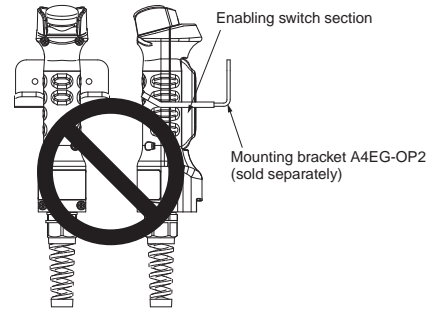

### Precautions for Correct Use

- Do not hold the Enabling Switch Device at Position 2 by any other methods except for handling. Otherwise, the original function of the Enabling Switch Device is not worked.

## Operating Environment

- This switch is designed for use indoors. Using the switch outdoors may damage it.
- The switch contacts can be used with either standard loads or microloads. Once the contact be used to switch smaller loads. The contact surfaces will become rough once they have been used and contact reliability for smaller loads may be reduced.
- Do not use the switch in the following locations.
  - Locations where the interior of the Protective Door may into direct contact with cutting chips, metal filings, oil chemicals
  - Locations subject to detergents, thinners, or other solvents
  - Locations subject to sudden temperature changes
  - Locations subject to high humidity and condensation
  - Locations subject to severe vibration
- Do not use the switch where corrosive gasses (e.g., H<sub>2</sub>S, SO<sub>2</sub>, NH<sub>3</sub>, HNO<sub>3</sub>, or Cl<sub>2</sub>) are present or in locations subject to high temperature and humidity. Doing so may result in damage to the switch as a result of contact failure or corrosion.
- Do not store the switch where corrosive gasses (e.g., H<sub>2</sub>S, SO<sub>2</sub>, NH<sub>3</sub>, HNO<sub>3</sub>, or Cl<sub>2</sub>) or dust are present or in high temperature and humidity.
- If the switch is not turned ON and OFF for a long period of time, contact resistance may be increased or continuity failure may occur due to contact oxidation.

## Mounting Method

### Specified Tightening Torque

Loose screws may result in malfunction. Tighten the screws at the specified torques.

Item	Specified torque
Cover mounting screw	1.1 to 1.3 N-m
Terminal screw	0.4 to 0.5 N-m
Holding Key mounting screw	0.5 to 0.7 N-m
Conduit Connector mounting (Conforming spanner 27 mm (width across flats))	2.0 to 2.4 N-m
Mounting Bracket	2.4 to 2.8 N-m

### Cover Mounting

- Dislocation of the seal rubber or foreign substance on the seal rubber reduces seal performance of the switch. Mount the cover after confirming that there is no abnormality on the seal rubber. If the seal rubber cracks or breaks, replace the Cover with a new one (A4EG-OP1 Rubber Cover, separately sold).
- Do not touch the rubber boot with sharp objects. Otherwise, the rubber boot may break and the operating characteristics and the seal performance may not be satisfied.



## Installing Mounting Bracket

- Securely install the Mounting Bracket using M5 screws and washers and tighten them to a torque of 2.4 to 2.8 N·m.

## Holding Key Type (sold separately)

- Use the A4EG-OP3 Holding Key when using the A4EG combining with the door switch.
- Use the D4NS Safety-door Switch.
- Loose screws may result in malfunction. Tighten the screws at the specified torques. Adhesive is recommended to prevent screws from being loose.

The specified torque: 0.5 to 0.7 N·m (Mounting screw, 2pcs.)

- Do not impose excessive force on the tip of the Holding Key or do not drop the switch body when the Holding Key is mounted on the switch body. Otherwise the Holding Key may deform or break. Stop using in case that deformation or breakage of the Holding Key occurs.
- Use the provide Spring washers and Mounting screws when mounting the Holding Key. Fit a tip of a slotted-screw driver on the head of the Mounting screw as shown in the following figure when tightening Mounting screws. The Mounting screws cannot be released once tightened.

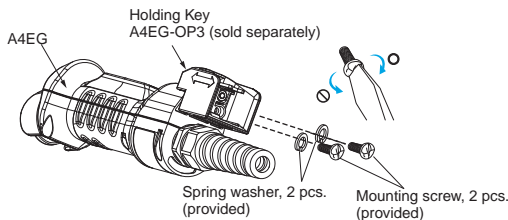

- As shown in figure 1 in *Precautions for Safe Use*, install the D4NS so that its mounting surface is above the highest part of the A4EG.
- As shown in figure 1 in the *Precautions for Safe Use*, use the Holding Key inserted vertically to the insert hole.

## Using the A4EG-BE2R041 (Enabling Grip Switch Equipped with an Emergency Stop Button)

If the A4EG is installed in a machine, do not use the A4EG alone as an emergency stop switch or as an emergency shutoff switch as specified by SEMI-S2.

SEMI-S2 specifies the installation of emergency shutoff switches at specified intervals on equipment. The A4EG can be removed from the equipment, and so may not satisfy the requirements of SEMI. Use the A4EG in combination with emergency stop switches or emergency shutoff switches that are installed at fixed positions.

## Wiring

- Confirm that safety is satisfied on the operation of the equipment to wire.
- Do not put the electric power when wiring. Otherwise electric shock may occur.
- Use an adequate diameter of cable. The seal performance is reduced when the diameter is smaller than the adequate diameter.
- Use the conforming sizes of lead wires to the apply voltage and current.

### Conforming cable size

Recommended multi-wire cable size: AWG20 to 18  
(0.5 to 0.75 mm<sup>2</sup>)

Recommended cable diameter: 8.0 to 13 mm  
(used with provided Conduit Connector)

- Do not pull the lead wires with excessive force. Doing so may disconnect them.

- Do not pull the cable when the Enabling Switch Device is hung on the Bracket.

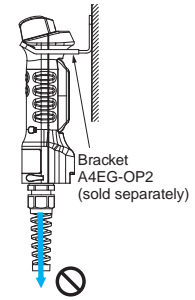

- Use crimp terminals with insulator tube for wiring. Recommended crimp terminal (Ring tongue terminal, Nylon-insulated): J.S.T. Mfg Co. FN1.25-3.7 (F Type)/N1.25-3.7 (Straight Type)

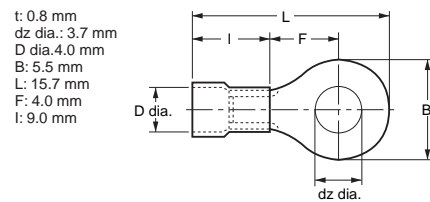

- Cut and crimp the lead wires in length as shown in the following table. Otherwise, excess length may cause the cover to rise and not fit properly.

Lead Wire Lengths

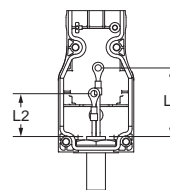

Terminal Arrangement

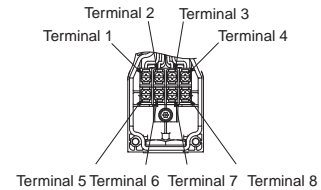

Length of lead wires	Terminal No.	1-4	5-8
L1/L2 (Length to the centers of crimp terminals)		40±2 mm	25±2 mm

- Do not let particles such as small piece of lead wire in the switch body when wiring.

## Terminal No. and Circuit Configuration

Model	Circuit	Terminal No.
A4EG-C000041	Enable output	1-2, 3-4
	Grip output	5-6
A4EG-BE2R041	Enable output	1-2, 3-4
	Emergency Stop Pushbutton Switch output	5-6, 7-8
A4EG-BM2B041	Enable output	1-2, 3-4
	Pushbutton Switch output	5-6, 7-8

- Assemble all of the parts without leaving any parts as shown in the following figure when mounting Conduit Connector. Mount Rubber packing, Conduit part, Cable Seal part and Spiral Nut part in order.

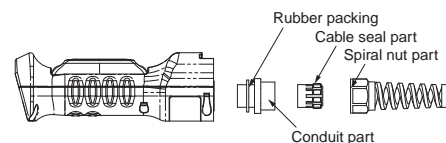

- Both of the switches is ON when pushing the two push buttons simultaneously. Confirm that safety is satisfied on the operation of the equipment to wire. (A4EG-BM2B041)
- Perform maintenance inspections periodically.



**MEMO**

A large grid of dashed lines, intended for writing a memo. The grid consists of 20 columns and 30 rows of small squares, forming a large rectangular area for text.





**OMRON Corporation Industrial Automation Company**  
Tokyo, JAPAN

Contact: [www.ia.omron.com](http://www.ia.omron.com)

**Regional Headquarters**

**OMRON EUROPE B.V.**

Wegalaan 67-69-2132 JD Hoofddorp  
The Netherlands  
Tel: (31)2356-81-300/Fax: (31)2356-81-388

**OMRON SCIENTIFIC TECHNOLOGIES INC.**

6550 Dumbarton Circle, Fremont  
CA 94555-3605 U.S.A.  
Tel: (1) 510-608-3400/Fax: (1) 510-744-1442

**OMRON ASIA PACIFIC PTE. LTD.**

No. 438A Alexandra Road # 05-05/08 (Lobby 2),  
Alexandra Technopark,  
Singapore 119967  
Tel: (65) 6835-3011/Fax: (65) 6835-2711

**OMRON (CHINA) CO., LTD.**

Room 2211, Bank of China Tower,  
200 Yin Cheng Zhong Road,  
PuDong New Area, Shanghai, 200120, China  
Tel: (86) 21-5037-2222/Fax: (86) 21-5037-2200

**Authorized Distributor:**

© OMRON Corporation 2009 All Rights Reserved.  
In the interest of product improvement,  
specifications are subject to change without notice.

CSM\_5\_1\_1213  
Cat. No. C142-E1-01

Printed in Japan  
1007-3M (1007) (H)