

## Large Square-bodied Lighted Pushbutton Switches

- Excellent operating sensitivity.
- Excellent illumination with even surface brightness.
- Three-color models (green, orange, red; chameleon lighting) included in lineup.



 Refer to *Safety Precautions for All Pushbutton Switches/Indicators* and *Safety Precautions* on page 24.

### List of Models

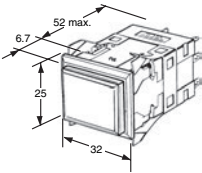
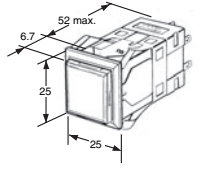
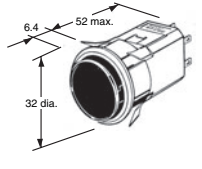
Model	Appearance
A3PJ (Rectangular)	
A3PA (Square)	
A3PT (Round)	

Note: The A3PJ is shown in the figure above as an example.

■ Specifications: Refer to page 15. ■ Panel cutout: Refer to page 21. ■ Dimensions: Refer to page 18.  
 ■ Accessories, replacements, and tools: Refer to pages 13 to 15. ■ Precautions for correct use: Refer to page 24.

## Model Number Structure

**Model Number Legend** ..... The model numbers used to order sets of Units are illustrated below. One set comprises the Pushbutton, Lamp, and Switch.

For information on combinations, refer to *Ordering Information* on pages 3 to 7.

(5) (6)  
**24E R** ..... Single screen  
 Upper Lower

(1) (2) (3) (4)  
**A 3 P J - 90 B 1 1 - 24E RW** ..... Horizontal 2-split screen  
 R (Red) Upper  
 W (White) Lower

**(1) Shape of Pushbutton**

Symbol	Shape
J	Rectangular
A	Square
T	Round

► Momentary operation: Self-resetting  
 ► Alternate operation: Self-holding

**(2) Switch Specifications Standard Load**

Symbol	Operation	
A	Momentary	SPDT
B	Alternate	
C	Momentary	DPDT
D	Alternate	

**Microload**

Symbol	Operation	
E	Momentary	SPDT
F	Alternate	
G	Momentary	DPDT
H	Alternate	

- Standard Load  
250 VAC, 3 A  
30 VDC, 3 A
- Microload  
125 VAC, 0.1 A  
30 VDC, 0.1 A

Minimum applicable load  
5 VDC, 1 mA

- 3PDT models are also available. Select from among the individual products shown on page 12.

**(3) Screen Pattern**

Illumination-only models	
Symbol	Screen pattern
1	Single screen 
2	2-split screen 
G	Chameleon *1 

Note: 1. The chameleon screen pattern is not available with A3PT models.  
 2. The chameleon screen pattern is only available with 12 or 24-VDC models.

\*1. With chameleon models, the whole screen lights red, green, or orange. When not lit, the display is white.

- The available rectangular models are shown below. Select from among the individual products shown on page 10.

Vertical 2-split screen models  



4-split screen models  



Horizontal 3-split screen models  

Vertical 3-split screen models  

The above diagrams show the Switches with the "OMRON" mark facing down.

- Colored-illumination models up to the 4-split screen models are available as individual Units. Refer to page 8.
- "Colored-illumination" models operate in the way shown below:

Unlit  
White  

Lit  
Color  

The built-in LED is colored.

**(4) Case Color**

Symbol	Color
1	Black
2	Light gray

Note: A3PT models are available in light gray only.

**(5) Lighting Method**

**LED-lighted Models (A3PJ and A3PA Models Only)**

Symbol	Rated voltage
05E	5 VDC
12E	12 VDC
24E	24 VDC

**LED Lamp-lighted Models (A3PT Only)**

Symbol	Rated voltage
05C	5 VDC
12C	12 VDC
24C	24 VDC

- A3PJ and A3PA can also be ordered separately. Refer to page 10 for details.

**Incandescent Lamp-lighted Models**

Symbol	Rated voltage
06	6 VAC/VDC
14	14 VAC/VDC
28	28 VAC/VDC

**(6) Color of Pushbutton For LED**

Symbol	Color
R	Red
O	orange
G	green
W	white
K	Chameleon

- The chameleon screen pattern is not available with A3PT models.
- The chameleon screen pattern is only available with 12 or 24-VDC models.

**For Incandescent Lamp**

Symbol	Color
No symbol	Red, orange, white, blue, green

- Includes colored plate. Refer to page 11 for details.

### Number of LED Lamps

Screen pattern	A3PJ	A3PA	A3PT
Single screen	Models with built-in LED		2
Horizontal 2-split screen			---
Vertical 2-split screen	4 *2	---	---
Horizontal 3-split screen			---
Vertical 3-split screen			---
4-split screen	---	---	---

\*2. These split screen models are available only as individual Units. They cannot be ordered as sets.

### Number of Incandescent Lamps

Screen pattern	A3PJ	A3PA	A3PT
Single screen	2	1	2
Horizontal 2-split screen	4 (Low-power incandescent lamp)	2	---
Vertical 2-split screen		---	---
Horizontal 3-split screen		---	---
4-split screen		---	---

Note: Lamp positions for single-screen A3PJ (rectangular model).



## Ordering Information

**Ordering as a Set** ..... The model numbers used to order sets of Units are given in the following tables. One set comprises the Pushbutton, Lamp, and Switch.  
(Not all combinations are possible. Ask your OMRON representative for details.)



### Standard Loads

Output	Lighting	Contact type Operation	Standard load (250 VAC, 3 A; 30 VDC, 4 A)				Pushbutton color symbol	
			Case color	Momentary operation (Self-resetting)		Alternate operation (Self-holding)		
				Black	Light gray	Black		Light gray
SPDT	LED	5 VDC	A3PJ-90A11-05E(1)	A3PJ-90A12-05E(1)	A3PJ-90B11-05E(1)	A3PJ-90B12-05E(1)	R O G W	
		12 VDC	A3PJ-90A11-12E(1)	A3PJ-90A12-12E(1)	A3PJ-90B11-12E(1)	A3PJ-90B12-12E(1)		
		24 VDC	A3PJ-90A11-24E(1)	A3PJ-90A12-24E(1)	A3PJ-90B11-24E(1)	A3PJ-90B12-24E(1)		
	Chameleon	12 VDC	A3PJ-90AG1-12EK	---	A3PJ-90BG1-12EK	A3PJ-90BG2-12EK	*1	
		24 VDC	A3PJ-90AG1-24EK	A3PJ-90AG2-24EK	A3PJ-90BG1-24EK	A3PJ-90BG2-24EK		
	Incandescent lamp	6 VDC/VAC	A3PJ-90A11-06	A3PJ-90A12-06	A3PJ-90B11-06	A3PJ-90B12-06	*2	
		14 VDC/VAC	A3PJ-90A11-14	A3PJ-90A12-14	A3PJ-90B11-14	A3PJ-90B12-14		
		28 VDC/VAC	A3PJ-90A11-28	A3PJ-90A12-28	A3PJ-90B11-28	A3PJ-90B12-28		
	DPDT	LED	5 VDC	A3PJ-90C11-05E(1)	A3PJ-90C12-05E(1)	A3PJ-90D11-05E(1)	A3PJ-90D12-05E(1)	R O G W
12 VDC			A3PJ-90C11-12E(1)	A3PJ-90C12-12E(1)	A3PJ-90D11-12E(1)	A3PJ-90D12-12E(1)		
24 VDC			A3PJ-90C11-24E(1)	A3PJ-90C12-24E(1)	A3PJ-90D11-24E(1)	A3PJ-90D12-24E(1)		
Chameleon		12 VDC	A3PJ-90CG1-12EK	A3PJ-90CG2-12EK	A3PJ-90DG1-12EK	---	*1	
		24 VDC	A3PJ-90CG1-24EK	A3PJ-90CG2-24EK	A3PJ-90DG1-24EK	A3PJ-90DG2-24EK		
Incandescent lamp		6 VDC/VAC	A3PJ-90C11-06	A3PJ-90C12-06	A3PJ-90D11-06	A3PJ-90D12-06	*2	
		14 VDC/VAC	A3PJ-90C11-14	A3PJ-90C12-14	A3PJ-90D11-14	A3PJ-90D12-14		
		28 VDC/VAC	A3PJ-90C11-28	A3PJ-90C12-28	A3PJ-90D11-28	A3PJ-90D12-28		

Note: Enter the desired color symbol for the Pushbutton in (1). (R) = Red, (O) = Orange, (G) = Green, (W) = White.

Example: Red A3PJ-90A11-24E R

\*1. You can change the screen colors of chameleon models between red, green, and orange, by changing the terminal wiring. Refer to page 20 for details.  
\*2. Incandescent lamps are supplied with colored plates (white, red, green, blue, and orange) and legend plates (milk-white and transparent). Use the appropriate combination.

### Microloads

Output	Lighting	Contact type Operation	Microload (125 VAC, 0.1 A; 30 VDC, 0.1 A)		Pushbutton color symbol	
			Case color	Momentary operation (Self-resetting)		
				Black		Light gray
SPDT	LED	5 VDC	A3PJ-90E11-05E(1)	A3PJ-90E12-05E(1)	R O G W	
		12 VDC	A3PJ-90E11-12E(1)	A3PJ-90E12-12E(1)		
		24 VDC	A3PJ-90E11-24E(1)	A3PJ-90E12-24E(1)		
	Chameleon	12 VDC	A3PJ-90EG1-12EK	---	*1	
		24 VDC	A3PJ-90EG1-24EK	A3PJ-90EG2-24EK		
	Incandescent lamp	6 VDC/VAC	A3PJ-90E11-06	A3PJ-90E12-06	*2	
		14 VDC/VAC	A3PJ-90E11-14	---		
		28 VDC/VAC	A3PJ-90E11-28	A3PJ-90E12-28		
	DPDT	LED	5 VDC	A3PJ-90G11-05E(1)	---	R O G W
12 VDC			A3PJ-90G11-12E(1)	A3PJ-90G12-12E(1)		
24 VDC			A3PJ-90G11-24E(1)	A3PJ-90G12-24E(1)		
Chameleon		12 VDC	A3PJ-90GG1-12EK	---	*1	
		24 VDC	A3PJ-90GG1-24EK	---		
Incandescent lamp		6 VDC/VAC	A3PJ-90G11-06	A3PJ-90G12-06	*2	
		14 VDC/VAC	A3PJ-90G11-14	A3PJ-90G12-14		
		28 VDC/VAC	A3PJ-90G11-28	A3PJ-90G12-28		

Note: Enter the desired color symbol for the Pushbutton in (1). (R) = Red, (O) = Orange, (G) = Green, (W) = White.

Example: Red A3PJ-90E11-24E R

\*1. You can change the screen colors of chameleon models between red, green, and orange, by changing the terminal wiring. Refer to page 20 for details.  
\*2. Incandescent lamps are supplied with colored plates (white, red, green, blue, and orange) and legend plates (milk-white and transparent). Use the appropriate combination.

Individual models: Refer to pages 9 to 12.  
(The Pushbutton, Lamp, and Switch can be ordered separately.)

■ Specifications: Refer to page 15. ■ Dimensions: Refer to page 18.  
■ Accessories: Refer to pages 13 to 15.

## Ordering Information

**Ordering as a Set**.....The model numbers used to order sets of Units are given in the following tables. One set comprises the Pushbutton, Lamp, and Switch.  
(Not all combinations are possible. Ask your OMRON representative for details.)

Rectangular Models	(Horizontal 2-split Screen)		(Horizontal 2-split Screen)	(1)
				(2)

A3P

### Standard Loads

Output	Lighting	Contact type Operation	Standard load (250 VAC, 3 A; 30 VDC, 4 A)				Pushbutton color symbol	
			Case color	Momentary operation (Self-resetting)		Alternate operation (Self-holding)		
				Black	Light gray	Black		Light gray
SPDT	LED	5 VDC	A3PJ-90A21-24E(1)(2)	A3PJ-90A22-24E(1)(2)	A3PJ-90B21-24E(1)(2)	A3PJ-90B22-24E(1)(2)	R O G W	
	Incandescent lamp	6 VDC/VAC	A3PJ-90A21-06	A3PJ-90A22-06	A3PJ-90B21-06	A3PJ-90B22-06	*	
		14 VDC/VAC	A3PJ-90A21-14	A3PJ-90A22-14	A3PJ-90B21-14	A3PJ-90B22-14		
28 VDC/VAC	A3PJ-90A21-28	A3PJ-90A22-28	A3PJ-90B21-28	A3PJ-90B22-28				
DPDT	LED	24 VDC	A3PJ-90C21-24E(1)(2)	A3PJ-90C22-24E(1)(2)	A3PJ-90D21-24E(1)(2)	A3PJ-90D22-24E(1)(2)	R O G W	
	Incandescent lamp	6 VDC/VAC	A3PJ-90C21-06	A3PJ-90C22-06	A3PJ-90D21-06	A3PJ-90D22-06	*	
		14 VDC/VAC	A3PJ-90C21-14	A3PJ-90C22-14	A3PJ-90D21-14	A3PJ-90D22-14		
28 VDC/VAC	A3PJ-90C21-28	A3PJ-90C22-28	A3PJ-90D21-28	A3PJ-90D22-28				

Note: Enter the desired color symbols for the Pushbutton in (1) and (2). (R) = Red, (O) = Orange, (G) = Green, (W) = White.

Example: 

Red
White

 Upper A3PJ-90D21-24E(RW)  
Lower Red White

\* Incandescent lamps are supplied with colored plates (white, red, green, blue, and orange) and legend plates (milky white and transparent). Use the appropriate combination.

Rectangular Models	(Horizontal 2-split Screen)		(Horizontal 2-split Screen)	(1)
				(2)

A3P

### Microloads

Output	Lighting	Contact type Operation	Microload (125 VAC, 0.1 A; 30 VDC, 0.1 A)		Pushbutton color symbol	
			Case color	Momentary operation (Self-resetting)		
				Black		Light gray
SPDT	LED	5 VDC	A3PJ-90E21-24E(1)(2)	A3PJ-90E22-24E(1)(2)	R O G W	
	Incandescent lamp	6 VDC/VAC	A3PJ-90E21-06	A3PJ-90E22-06	*	
		14 VDC/VAC	A3PJ-90E21-14	A3PJ-90E22-14		
28 VDC/VAC	A3PJ-90E21-28	A3PJ-90E22-28				
DPDT	LED	5 VDC	A3PJ-90G21-24E(1)(2)	A3PJ-90G22-24E(1)(2)	R O G W	
	Incandescent lamp	6 VDC/VAC	A3PJ-90G21-06	A3PJ-90G22-06	*	
		14 VDC/VAC	A3PJ-90G21-14	A3PJ-90G22-14		
28 VDC/VAC	A3PJ-90G21-28	A3PJ-90G22-28				

Note: Enter the desired color symbols for the Pushbutton in (1) and (2). (R) = Red, (O) = Orange, (G) = Green, (W) = White.

Example: 

Red
White

 Upper A3PJ-90D21-24E(RW)  
Lower Red White

\* Incandescent lamps are supplied with colored plates (white, red, green, blue, and orange) and legend plates (milky-white and transparent). Use the appropriate combination.

Individual models: Refer to pages 9 to 12.  
(The Pushbutton, Lamp, and Switch can be ordered separately.)

■ Specifications: Refer to page 15. ■ Dimensions: Refer to page 18.  
■ Accessories: Refer to pages 13 to 15.

## Ordering Information

**Ordering as a Set** ..... The model numbers used to order sets of Units are given in the following tables. One set comprises the Pushbutton, Lamp, and Switch.  
(Not all combinations are possible. Ask your OMRON representative for details.)



### Standard Loads

Output	Lighting	Contact type Operation Case color	Standard load (250 VAC, 3 A; 30 VDC, 4 A)				Pushbutton color symbol
			Momentary operation (Self-resetting)		Alternate operation (Self-holding)		
			Black	Light gray	Black	Light gray	
SPDT	LED	5 VDC	A3PA-90A11-05E(1)	A3PA-90A12-05E(1)	A3PA-90B11-05E(1)	A3PA-90B12-05E(1)	R O G W
		12 VDC	A3PA-90A11-12E(1)	A3PA-90A12-12E(1)	A3PA-90B11-12E(1)	A3PA-90B12-12E(1)	
		24 VDC	A3PA-90A11-24E(1)	A3PA-90A12-24E(1)	A3PA-90B11-24E(1)	A3PA-90B12-24E(1)	
	Chameleon	12 VDC	A3PA-90AG1-12EK	A3PA-90AG2-12EK	A3PA-90BG1-12EK	A3PA-90BG2-12EK	*1
		24 VDC	A3PA-90AG1-24EK	A3PA-90AG2-24EK	A3PA-90BG1-24EK	A3PA-90BG2-24EK	
	Incandescent lamp	6 VDC/VAC	A3PA-90A11-06	A3PA-90A12-06	A3PA-90B11-06	A3PA-90B12-06	*2
14 VDC/VAC		A3PA-90A11-14	A3PA-90A12-14	A3PA-90B11-14	A3PA-90B12-14		
28 VDC/VAC		A3PA-90A11-28	A3PA-90A12-28	A3PA-90B11-28	A3PA-90B12-28		
DPDT	LED	5 VDC	A3PA-90C11-05E(1)	A3PA-90C12-05E(1)	A3PA-90D11-05E(1)	A3PA-90D12-05E(1)	R O G W
		12 VDC	A3PA-90C11-12E(1)	A3PA-90C12-12E(1)	A3PA-90D11-12E(1)	A3PA-90D12-12E(1)	
		24 VDC	A3PA-90C11-24E(1)	A3PA-90C12-24E(1)	A3PA-90D11-24E(1)	A3PA-90D12-24E(1)	
	Chameleon	12 VDC	A3PA-90CG1-12EK	A3PA-90CG2-12EK	A3PA-90DG1-12EK	A3PA-90DG2-12EK	*1
		24 VDC	A3PA-90CG1-24EK	A3PA-90CG2-24EK	A3PA-90DG1-24EK	A3PA-90DG2-24EK	
	Incandescent lamp	6 VDC/VAC	A3PA-90C11-06	A3PA-90C12-06	A3PA-90D11-06	A3PA-90D12-06	*2
14 VDC/VAC		A3PA-90C11-14	A3PA-90C12-14	A3PA-90D11-14	A3PA-90D12-14		
28 VDC/VAC		A3PA-90C11-28	A3PA-90C12-28	A3PA-90D11-28	A3PA-90D12-28		

Note: Enter the desired color symbol for the Pushbutton in (1). (R) = Red, (O) = Orange, (G) = Green, (W) = White.

Example: Red A3PA-90A11-24ER

- \*1. You can change the screen colors of chameleon models between red, green, and orange, by changing the terminal wiring. Refer to page 20 for details.
- \*2. Incandescent lamps are supplied with colored plates (white, red, green, blue, and orange) and legend plates (milk-white and transparent). Use the appropriate combination.

### Microloads

Output	Lighting	Contact type Operation Case color	Microload (125 VAC, 0.1 A; 30 VDC, 0.1 A)		Pushbutton color symbol
			Momentary operation (Self-resetting)		
			Black	Light gray	
SPDT	LED	5 VDC	A3PA-90E11-05E(1)	A3PA-90E12-05E(1)	R O G W
		12 VDC	A3PA-90E11-12E(1)	A3PA-90E12-12E(1)	
		24 VDC	A3PA-90E11-24E(1)	A3PA-90E12-24E(1)	
	Chameleon	12 VDC	A3PA-90EG1-12EK	---	*1
		24 VDC	A3PA-90EG1-24EK	A3PA-90EG2-24EK	
	Incandescent lamp	6 VDC/VAC	A3PA-90E11-06	A3PA-90E12-06	*2
14 VDC/VAC		---	A3PA-90E12-14		
28 VDC/VAC		A3PA-90E11-28	A3PA-90E12-28		
DPDT	LED	5 VDC	---	---	R O G W
		12 VDC	A3PA-90G11-12E(1)	A3PA-90G12-12E(1)	
		24 VDC	A3PA-90G11-24E(1)	A3PA-90G12-24E(1)	
	Chameleon	12 VDC	A3PA-90GG1-12EK	---	*1
		24 VDC	A3PA-90GG1-24EK	---	
	Incandescent lamp	6 VDC/VAC	A3PA-90G11-06	A3PA-90G12-06	*2
14 VDC/VAC		---	---		
28 VDC/VAC		A3PA-90G11-28	A3PA-90G12-28		

Note: Enter the desired color symbol for the Pushbutton in (1). (R) = Red, (O) = Orange, (G) = Green, (W) = White.

Example: Red A3PA-90E11-24ER

- \*1. You can change the screen colors of chameleon models between red, green, and orange, by changing the terminal wiring. Refer to page 20 for details.
- \*2. Incandescent lamps are supplied with colored plates (white, red, green, blue, and orange) and legend plates (milk-white and transparent). Use the appropriate combination.

Individual models: Refer to pages 9 to 12. (The Pushbutton, Lamp, and Switch can be ordered separately.)	<ul style="list-style-type: none"> <li>■ Specifications: Refer to page 15. ■ Dimensions: Refer to page 18.</li> <li>■ Accessories: Refer to pages 13 to 15.</li> </ul>
---	--

## Ordering Information

**Ordering as a Set** ..... The model numbers used to order sets of Units are given in the following tables. One set comprises the Pushbutton, Lamp, and Switch.  
(Not all combinations are possible. Ask your OMRON representative for details.)

Square Models	(Horizontal 2-split Screen)		A3PA	(Horizontal 2-split Screen)	(1)
					(2)

### Standard Loads

Output	Lighting	Contact type Operation	Standard load (250 VAC, 3 A; 30 VDC, 4 A)				Pushbutton color symbol	
			Case color	Momentary operation (Self-resetting)		Alternate operation (Self-holding)		
				Black	Light gray	Black		Light gray
SPDT	LED	24 VDC	A3PA-90A21-24E(1)(2)	A3PA-90A22-24E(1)(2)	A3PA-90B21-24E(1)(2)	A3PA-90B22-24E(1)(2)	R O G W	
		6 VDC/VAC	A3PA-90A21-06	A3PA-90A22-06	A3PA-90B21-06	A3PA-90B22-06	*	
		14 VDC/VAC	A3PA-90A21-14	A3PA-90A22-14	A3PA-90B21-14	A3PA-90B22-14		
		28 VDC/VAC	A3PA-90A21-28	A3PA-90A22-28	A3PA-90B21-28	A3PA-90B22-28		
DPDT	LED	24 VDC	A3PA-90C21-24E(1)(2)	A3PA-90C22-24E(1)(2)	A3PA-90D21-24E(1)(2)	A3PA-90D22-24E(1)(2)	R O G W	
		6 VDC/VAC	A3PA-90C21-06	A3PA-90C22-06	A3PA-90D21-06	A3PA-90D22-06	*	
		14 VDC/VAC	A3PA-90C21-14	A3PA-90C22-14	A3PA-90D21-14	A3PA-90D22-14		
		28 VDC/VAC	A3PA-90C21-28	A3PA-90C22-28	A3PA-90D21-28	A3PA-90D22-28		

Note: Enter the desired color symbols for the Pushbutton in (1) and (2). (R) = Red, (O) = Orange, (G) = Green, (W) = White.

Example: 

Red
White

 Upper A3PA-90D21-24E 

R	W
---	---

  
Lower Red White

\* Incandescent lamps are supplied with colored plates (white, red, green, blue, and orange) and legend plates (milk-white and transparent). Use the appropriate combination.

Square Models	(Horizontal 2-split Screen)		A3PA	(Horizontal 2-split Screen)	(1)
					(2)

### Microloads

Output	Lighting	Contact type Operation	Microload (125 VAC, 0.1 A; 30 VDC, 0.1 A)		Pushbutton color symbol	
			Case color	Momentary operation (Self-resetting)		
				Black		Light gray
SPDT	LED	24 VDC	A3PA-90E21-24E(1)(2)	A3PA-90E22-24E(1)(2)	R O G W	
		6 VDC/VAC	A3PA-90E21-06	A3PA-90E22-06	*	
		14 VDC/VAC	A3PA-90E21-14	A3PA-90E22-14		
		28 VDC/VAC	A3PA-90E21-28	A3PA-90E22-28		
DPDT	LED	24 VDC	A3PA-90G21-24E(1)(2)	A3PA-90G22-24E(1)(2)	R O G W	
		6 VDC/VAC	A3PA-90G21-06	A3PA-90G22-06	*	
		14 VDC/VAC	A3PA-90G21-14	A3PA-90G22-14		
		28 VDC/VAC	A3PA-90G21-28	A3PA-90G22-28		

Note: Enter the desired color symbols for the Pushbutton in (1) and (2). (R) = Red, (O) = Orange, (G) = Green, (W) = White.

Example: 

Red
White

 Upper A3PA-90D21-24E 

R	W
---	---

  
Lower Red White

\* Incandescent lamps are supplied with colored plates (white, red, green, blue, and orange) and legend plates (milk-white and transparent). Use the appropriate combination.

Individual models: Refer to pages 9 to 12.  
(The Pushbutton, Lamp, and Switch can be ordered separately.)

■ Specifications: Refer to page 15. ■ Dimensions: Refer to page 18.  
■ Accessories: Refer to pages 13 to 15.

## Ordering Information

**Ordering as a Set** ..... The model numbers used to order sets of Units are given in the following tables. One set comprises the Pushbutton, Lamp, and Switch.



### Standard Loads

Output	Lighting	Contact type Operation Case color	Standard load (250 VAC, 3 A; 30 VDC, 4 A)		Pushbutton color symbol
			Momentary operation (Self-resetting)	Alternate operation (Self-holding)	
			Light gray	Light gray	
SPDT	LED	24 VDC	A3PT-90A12-24C(1)	A3PT-90B12-24C(1)	R O G W
	Incandescent lamp	6 VDC/VAC	A3PT-90A12-06	A3PT-90B12-06	*
		14 VDC/VAC	A3PT-90A12-14	---	
		28 VDC/VAC	A3PT-90A12-28	A3PT-90B12-28	
DPDT	LED	24 VDC	A3PT-90C12-24C(1)	A3PT-90D12-24C(1)	R O G W
	Incandescent lamp	6 VDC/VAC	A3PT-90C12-06	A3PT-90D12-06	*
		14 VDC/VAC	A3PT-90C12-14	A3PT-90D12-14	
		28 VDC/VAC	A3PT-90C12-28	A3PT-90D12-28	

Note: Enter the desired color symbols for the Pushbutton in (1) and (2). (R) = Red, (O) = Orange, (G) = Green, (W) = White.

Example: (Red) A3PT-90A12-24C(R)

\* Incandescent lamps are supplied with a colored plates (white, red, green, blue, and orange). Use the appropriate combination. Models A3PT (round models), however, are not supplied with legend plates.



### Microloads

Output	Lighting	Contact type Operation Case color	Microload (125 VAC, 0.1 A; 30 VDC, 0.1 A)	Pushbutton color symbol
			Momentary operation (Self-resetting)	
			Light gray	
SPDT	LED	24 VDC	A3PT-90E12-24C(1)	R O G W
	Incandescent lamp	28 VDC/VAC	A3PT-90E12-28	*
DPDT	LED	24 VDC	A3PT-90G12-24C(1)	G W
	Incandescent lamp	28 VDC/VAC	A3PT-90G12-28	*

Note: Enter the desired color symbols for the Pushbutton in (1). (R) = Red, (O) = Orange, (G) = Green, (W) = White.

Example: (Red) A3PT-90E12-24C(R)

\* Incandescent lamps are supplied with a colored plates (white, red, green, blue, and orange). Use the appropriate combination. Models A3PT (round models), however, are not supplied with legend plates.

Individual models: Refer to pages 9 to 12.  
(The Pushbutton, Lamp, and Switch can be ordered separately.)

■ Specifications: Refer to page 15. ■ Dimensions: Refer to page 18.  
■ Accessories: Refer to pages 13 to 15.



## Ordering Information

### Illumination-only and Colored-illumination LED Models

“Illumination only” describes LED models for which the screen color is the same whether the LED is lit or not. The screen simply becomes brighter when the LED lights.

Example: Red LED

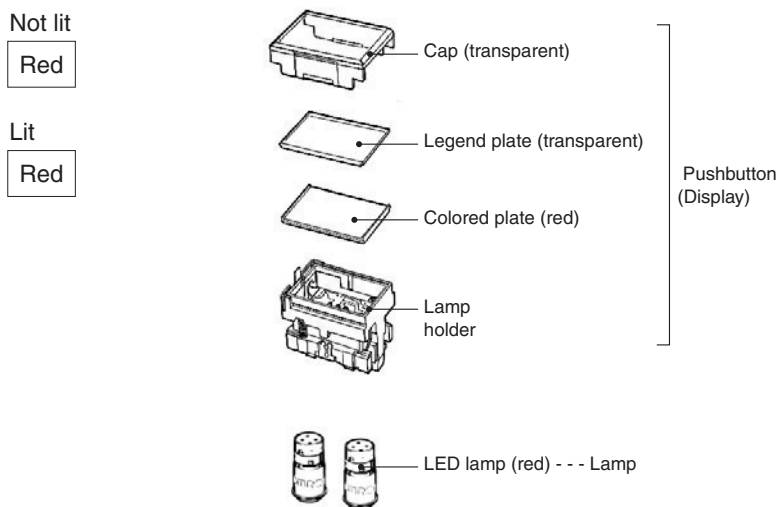

“Colored illumination” describes LED models for which the screen color is white when the LED is not lit and changes to the color of the LED lamp when the LED is lit.

Example: Red LED

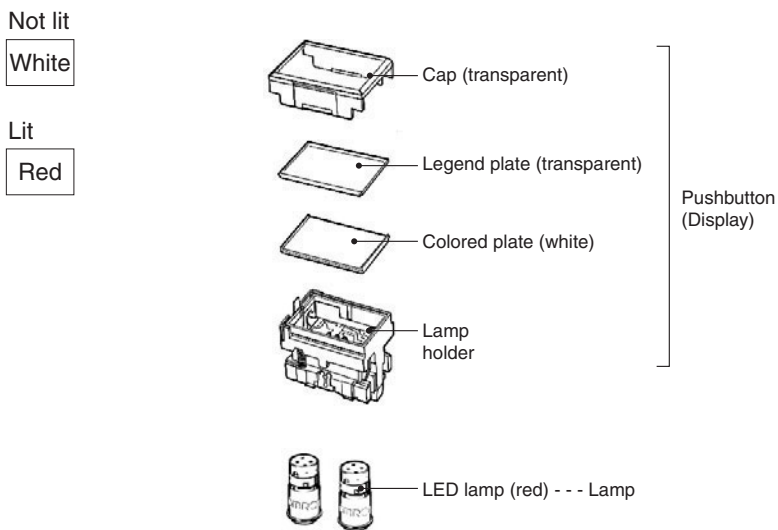

**Ordering: With colored-illumination models, order the Pushbutton, Lamp, and Switch as shown in the following table.**

Pushbutton	Lamp	Switch
Select the LED lamp-lighted model required from the selection on page 10. Each assembly includes the number of white colored plates required to enable colored illumination for the corresponding screen-split configuration. For example, 4-split screen models include 4 white colored plates.	Select the LED lamps to suit your desired coloration from the selection on page 12. Number of necessary LED lamps (standard) A3PJ (rectangular): 4 A3PA (square): 2 A3PT (round): 2	Select from the Switches on page 12.



## Ordering Information

**Ordering Individually** ..... Pushbuttons, Lamps, and Switches can be ordered separately. Combinations that are not available as sets can be created using individual Units. Also, store the parts as spares for maintenance and repairs.

### LED-lighted/Chameleon Models (LED is built into the Pushbutton.)

**Pushbutton**

Round (A3PT) models not available.

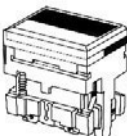

· For Pushbutton Switch  
A3P□-5□□□-□□E

### LED Lamp-lighted Models (LED lamp and Pushbutton are separate.)

**Pushbutton**

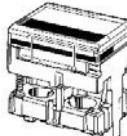

· For Pushbutton Switch  
A3P□-502□

### Incandescent Lamp-lighted Models (Incandescent lamp and Pushbutton are separate.)

**Pushbutton**

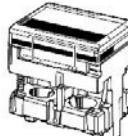

· For Pushbutton Switch  
A3P□-501□

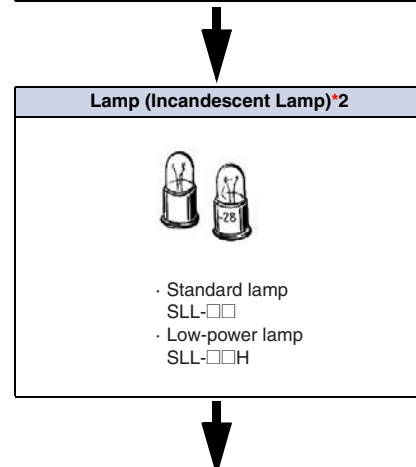
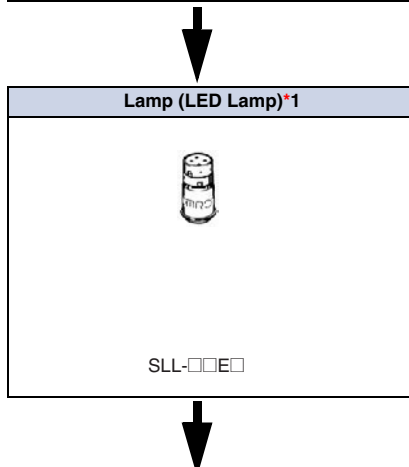
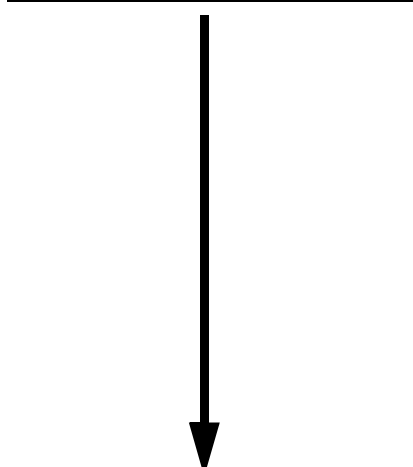

**Switch \***

Round (A3PT) models not available.

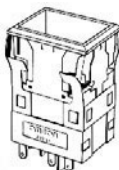

· For Pushbutton Switch  
A3P□-7□□□-□

**Lamp (LED Lamp)\*1**



SLL-□□□□

**Switch \***



· For Pushbutton Switch  
A3P□-7□□□-□

**Lamp (Incandescent Lamp)\*2**



· Standard lamp  
SLL-□□□  
· Low-power lamp  
SLL-□□□H

**Switch \***

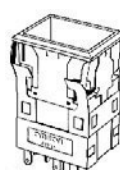

· For Pushbutton Switch  
A3P□-7□□□-□

\* The Switch is compatible with LED-lighted models, LED lamp-lighted models, and incandescent lamp-lighted models.

\*1. Number of necessary LED lamps.

Screen pattern	A3PJ	A3PA	A3PT
Single screen	4	2	2
Horizontal 2-split screen		2	---
Vertical 2-split screen		/	
Vertical 3-split screen			
Horizontal 3-split screen			
4-split screen			

\*2. Number of necessary incandescent lamps.

Screen pattern	A3PJ	A3PA	A3PT
Single screen	2	1	2
Horizontal 2-split screen	4 (low-power incandescent lamp)	2	---
Vertical 2-split screen		/	
Vertical 3-split screen			
Horizontal 3-split screen			
4-split screen			

Ordering set combinations: Refer to page 3 to 7.











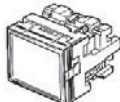

■ Specifications: Refer to page 15. ■ Dimensions: Refer to page 18.  
■ Accessories: Refer to pages 13 to 15.

## Ordering Information

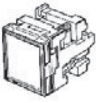
**Ordering Individually** ..... Pushbuttons, Lamps, and Switches can be ordered separately. Combinations that are not available as sets can be created using individual Units. Also, store the parts as spares for maintenance and repairs.

Pushbutton

### LED-lighted Models (LED is built-in.)

Appearance	Split-screen color (color symbol)	White (W)	Red (R)	Green (G)	Orange (O)	Selection precautions
 Rectangular models	Single screen		A3PJ-5701 -□□E	A3PJ-5702 -□□E	A3PJ-5703 -□□E	A3PJ-5706 -□□E
	Horizontal 2-split screen		A3PJ-5711 -□□E	A3PJ-5712 -□□E	A3PJ-5713 -□□E	A3PJ-5716 -□□E
			A3PJ-5721 -□□E	A3PJ-5722 -□□E	A3PJ-5723 -□□E	A3PJ-5726 -□□E
			A3PJ-5731 -□□E	A3PJ-5732 -□□E	A3PJ-5733 -□□E	A3PJ-5736 -□□E
			A3PJ-5741 -□□E	A3PJ-5742 -□□E	A3PJ-5743 -□□E	A3PJ-5746 -□□E
 Square models	Single screen		A3PA-5701 -□□E	A3PA-5702 -□□E	A3PA-5703 -□□E	A3PA-5706 -□□E
	Horizontal 2-split screen		A3PA-5711 -□□E	A3PA-5712 -□□E	A3PA-5713 -□□E	A3PA-5716 -□□E
			A3PA-5721 -□□E	A3PA-5722 -□□E	A3PA-5723 -□□E	A3PA-5726 -□□E
			A3PA-5731 -□□E	A3PA-5732 -□□E	A3PA-5733 -□□E	A3PA-5736 -□□E
			A3PA-5741 -□□E	A3PA-5742 -□□E	A3PA-5743 -□□E	A3PA-5746 -□□E









- Enter the voltage to be used in the □□ at the end of the model number.

Examples of voltages used:  
 5V=015E  
 12V=112E  
 24V=214E  
 Horizontal 2-split screen models support only 24V.

- For the color of the shaded part, select the model according to the colors given at the top of the table.

Note: 1. A cap, legend plate (transparent), colored plate, white plunger case, and LED (with a current-limiting resistor) are built into the standard lighting unit.  
 2. Split-screen coloring configurations are given with the OMRON mark on the Switch facing down.  
 3. The LED is built-in and cannot be replaced individually.

### LED Lamp-lighted Models (LED is not built-in.)

Appearance	Rectangular models	Square models	Round models	Selection precautions		
Screen pattern	Screen	Model	Screen	Model	Screen	Model
Single screen		A3PJ-5021		A3PA-5021		A3PT-5021
Horizontal 2-split screen		A3PJ-5022		A3PA-5022	---	---
Vertical 2-split screen		A3PJ-5023	---	---	---	---
Horizontal 3-split screen		A3PJ-5024	---	---	---	---
Vertical 3-split screen		A3PJ-5025	---	---	---	---
4-split screen		A3PJ-5026	---	---	---	---

Screen pattern	White	Red	Green	Orange
Single screen	1	1	1	1
Horizontal 2-split screens Vertical 2-split screens	2	1	1	1
Horizontal 3-split screens Vertical 3-split screens	3	2	2	2
4-split screen	4	1	1	1

- Parts included:  
 Colored plates (white, red, green, and orange), a legend plate (transparent), and a light baffle (split-screen models only) are included. Use the appropriate combination for the LED coloring required.
- The number of white colored plates required to enable colored illumination for the corresponding screen-split configuration is included. (For example, 4-split screen models include 4 white colored plates).
- The number of colored plates included for each model are shown in the following table.

Ordering set combinations: Refer to page 3 to 7.









- Specifications: Refer to page 15. ■ Dimensions: Refer to page 18.
- Accessories: Refer to pages 13 to 15.

## Ordering Information

**Ordering Individually** ..... Pushbuttons, Lamps, and Switches can be ordered separately. Combinations that are not available as sets can be created using individual Units. Also, store the parts as spares for maintenance and repairs.

Pushbutton

### Incandescent Lamp-lighted Models (Incandescent lamp is not built-in.)

Appearance	Rectangular models		Square models		Round models		Selection precautions																																										
	Screen	Model	Screen	Model	Screen	Model																																											
Single screen		A3PJ-5011		A3PA-5011		A3PT-5011 *	<ul style="list-style-type: none"> <li>Parts included: Colored plates (white, red, green, orange, and blue), legend plates (transparent and milk white), and a light baffle (split-screen models only) are supplied.</li> <li>* A3PT (round) models do not contain a legend plate.</li> <li>The number of colored plates included is shown in the following table.</li> </ul> <table border="1"> <thead> <tr> <th>Screen pattern</th> <th>White</th> <th>Red</th> <th>Green</th> <th>Orange</th> <th>Blue</th> </tr> </thead> <tbody> <tr> <td>Single screen</td> <td>1</td> <td>1</td> <td>1</td> <td>1</td> <td>1</td> </tr> <tr> <td>Horizontal 2-split screens</td> <td>1</td> <td>1</td> <td>1</td> <td>1</td> <td>1</td> </tr> <tr> <td>Horizontal 3-split screens</td> <td>2</td> <td>2</td> <td>2</td> <td>2</td> <td>2</td> </tr> <tr> <td>Vertical 2-split screens</td> <td>1</td> <td>1</td> <td>1</td> <td>1</td> <td>1</td> </tr> <tr> <td>Vertical 3-split screens</td> <td>2</td> <td>2</td> <td>2</td> <td>2</td> <td>2</td> </tr> <tr> <td>4-split screen</td> <td>2</td> <td>2</td> <td>2</td> <td>2</td> <td>2</td> </tr> </tbody> </table>	Screen pattern	White	Red	Green	Orange	Blue	Single screen	1	1	1	1	1	Horizontal 2-split screens	1	1	1	1	1	Horizontal 3-split screens	2	2	2	2	2	Vertical 2-split screens	1	1	1	1	1	Vertical 3-split screens	2	2	2	2	2	4-split screen	2	2	2	2	2
Screen pattern	White	Red	Green	Orange	Blue																																												
Single screen	1	1	1	1	1																																												
Horizontal 2-split screens	1	1	1	1	1																																												
Horizontal 3-split screens	2	2	2	2	2																																												
Vertical 2-split screens	1	1	1	1	1																																												
Vertical 3-split screens	2	2	2	2	2																																												
4-split screen	2	2	2	2	2																																												
Horizontal 2-split screen		A3PJ-5012		A3PA-5012	---																																												
Vertical 2-split screen		A3PJ-5013	---		---																																												
Horizontal 3-split screen		A3PJ-5014	---		---																																												
Vertical 3-split screen		A3PJ-5015	---		---																																												
4-split screen		A3PJ-5016	---		---																																												

### Chameleon Models (with Built-in LED)

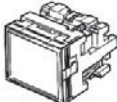
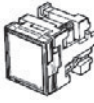
Appearance	Rated voltage	Chameleon pushbutton switch
 Rectangular	12 VDC	A3PJ-5800-12E
	24 VDC	A3PJ-5800-24E
 Square	12 VDC	A3PA-5800-12E
	24 VDC	A3PA-5800-24E

Note: 1. With chameleon models the whole screen lights red, green, or orange (i.e., red and green simultaneously).

2. A cap, legend plate (transparent), white colored plate, and LED (with a current-limiting resistor) are built into the Pushbutton.

Ordering set combinations: Refer to page 3 to 7.

■ Specifications: Refer to page 15. ■ Dimensions: Refer to page 18.  
■ Accessories: Refer to pages 13 to 15.

## Ordering Information

**Ordering Individually** ..... Pushbuttons, Lamps, and Switches can be ordered separately. Combinations that are not available as sets can be created using individual Units. Also, store the parts as spares for maintenance and repairs.

Pushbutton (For information on mounting, refer to page 25.)

### LED Lamp

Color	Voltage	5 VDC	12 VDC	24 VDC	Applicable cap (color) (colored plate)	Selection precautions
		Model (DC only)	Model (DC only)	Model (DC only)		
Red		SLL-05ER	SLL-12ER	SLL-24ER	Red	In the standard setup, 4 LED lamps are used with A3PJ models and 2 LED lamps are used with A3PA and A3PT models.
Yellow		SLL-05EY	SLL-12EY	SLL-24EY	Orange	
Green		SLL-05EG	SLL-12EG	SLL-24EG	Green	
White		SLL-05EW	SLL-12EW	SLL-24EW	White	

### Incandescent Lamp

Voltage	Lamp type	Standard lamp	Low-power lamp	Selection precautions
5 VAC/VDC		SLL-06	SLL-06H	<ul style="list-style-type: none"> <li>In the standard setup for A3PJ models, 2 lamps are used with single screen models, and 4 lamps are used with split-screen models. If 3 or 4 lamps are lit continuously, use low-power lamps.</li> <li>In the standard setup for A3PA models, 1 lamp is used with single screen models, and 2 lamps are used with split-screen models.</li> <li>In the standard setup for A3PT models, 2 lamps are used.</li> </ul>
12 VAC/VDC		SLL-14	SLL-14H	
24 VAC/VDC		SLL-28	SLL-28H	

Switch (common to both incandescent lamp-lighted models and LED models)

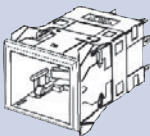
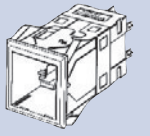
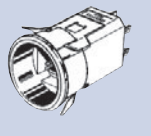
Appearance				Rectangular models	Square models	Round models	Selection precautions
							
Contact type	Switch Number of outputs	Operation	Model	Model	Model		
Standard load	Silver alloy contact	1	Momentary operation	A3PJ-7010-1	A3PA-7010-1	A3PT-7010-2	<ul style="list-style-type: none"> <li>The end digit denotes the color of the flange: -1 denotes a black flange, and -2 denotes a light gray flange. Round switches are available only in light gray, and not in black.</li> <li>Use the Switch in combination with the same shape Lamp (rectangular, square or round). Example: For rectangular Lamp A3PJ-5011, select Switch A3PJ-7□□□0-□. On the Switch itself, however, only 3 digits are shown, as follows: A3PJ-7□□.</li> <li>Momentary operation is self-resetting, and alternate operation is self-holding (i.e., push-on, push-off).</li> </ul>
			Alternate operation	A3PJ-7020-1	A3PA-7020-1	A3PT-7020-2	
		2	Momentary operation	A3PJ-7030-1	A3PA-7030-1	A3PT-7030-2	
			Alternate operation	A3PJ-7040-1	A3PA-7040-1	A3PT-7040-2	
		3	Momentary operation	A3PJ-7150-1	---	---	
			Alternate operation	A3PJ-7160-1	---	---	
Microload	Gold alloy contact	1	Momentary operation	A3PJ-7050-1	A3PA-7050-1	A3PT-7050-2	
			Alternate operation	A3PJ-7060-1	A3PA-7060-1	A3PT-7060-2	
		2	Momentary operation	A3PJ-7070-1	A3PA-7070-1	A3PT-7070-2	
			Alternate operation	A3PJ-7080-1	A3PA-7080-1	A3PT-7080-2	
		3	Momentary operation	A3PJ-7170-1	---	---	
			Alternate operation	A3PJ-7180-1	---	---	







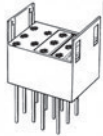

Ordering set combinations: Refer to page 3 to 7.

■ Specifications: Refer to page 15. ■ Dimensions: Refer to page 18.  
■ Accessories: Refer to pages 13 to 15.

## Ordering Information













### Accessories, Replacements, and Tools

#### Accessories

Name	Appearance	Classification		Rectangular	Square	Application precautions
Socket		Wire-wrap terminal		<b>A3PJ-4101</b>	<b>A3PA-4101</b>	<ul style="list-style-type: none"> <li>The Socket cannot be used with when mounting multiple Switches or with 3C models.</li> </ul>
		PCB terminal		<b>A3PJ-4102</b>	<b>A3PA-4102</b>	
		Solder terminal		<b>A3PJ-4103</b>	<b>A3PA-4103</b>	
Barrier		Short edge barrier (Horizontal mounting) (1 pair)	Black	<b>A3PJ-4001</b>	<b>A3PA-4001</b>	<ul style="list-style-type: none"> <li>The purpose of the barrier is to prevent malfunctioning and to improve design image of the mounting panel.</li> <li>Intermediate barrier × 1.</li> <li>Edge barriers × 1 pair (2 Units).</li> <li>Mount short barriers horizontally.</li> <li>Mount long barriers vertically.</li> <li>For details on mounting, refer to page 25.</li> </ul>
			Light gray	<b>A3PJ-4002</b>	<b>A3PA-4002</b>	
		Long edge barrier (Vertical mounting) (1 pair)	Black	<b>A3PJ-4004</b>	---	
			Light gray	<b>A3PJ-4005</b>		
		Short intermediate barrier (Horizontal mounting)	Black	<b>A3PJ-4007</b>	<b>A3PA-4007</b>	
			Light gray	<b>A3PJ-4008</b>	<b>A3PA-4008</b>	
		Long intermediate barrier (Vertical mounting)	Black	<b>A3PJ-4010</b>	---	
			Light gray	<b>A3PJ-4011</b>		
Switch guard		For horizontal mounting (with OMRON logo facing down)		<b>A3PJN-5050</b>	<b>A3PAN-5050</b>	<ul style="list-style-type: none"> <li>Can be used by exchanging with the cap.</li> <li>Cannot be used with seal cover.</li> <li>Can be used with barrier.</li> <li>Use horizontal mounting guard for consecutive horizontal mounting, and use vertical mounting guard for consecutive vertical mounting.</li> </ul>
		For vertical mounting (with OMRON logo facing to the right)		<b>A3PJN-5055</b>	<b>A3PAN-5055</b>	
Seal cover		---		<b>A3PJ-5060</b>	<b>A3PA-5060</b>	<ul style="list-style-type: none"> <li>Cannot be used with barrier and/or switch guard.</li> <li>For details on mounting, refer to page 25.</li> <li>Cap is manufactured from vinyl chloride.</li> </ul>
Long mounting plate		---		<b>A3PJ-3002</b>	---	<ul style="list-style-type: none"> <li>Use when vertically mounting individual (with barrier) or multiple Switches (in standard mounting style and with barrier). Since a short mounting plate is attached to the Switch, replace it with the long one.</li> </ul>

## Ordering Information

## Accessories

Name	Appearances	Classification	A3PJ	A3PA	Application precautions	
Colored plate for incandescent lamp		Single screen 	White	A3PJ-5101	A3PA-5101	<ul style="list-style-type: none"> <li>• Keep mounted at all times.</li> <li>• Contact your OMRON representative for color changes or other specifications.</li> <li>• For details on mounting, refer to page 25.</li> </ul>
			Red	A3PJ-5102	A3PA-5102	
			Green	A3PJ-5103	A3PA-5103	
			Blue	A3PJ-5104	A3PA-5104	
			Yellow	A3PJ-5105	A3PA-5105	
			Orange	A3PJ-5106	A3PA-5106	
		Horizontal 2-split screen 	White	A3PJ-5121	A3PA-5121	
			Red	A3PJ-5122	A3PA-5122	
			Green	A3PJ-5123	A3PA-5123	
			Blue	A3PJ-5124	A3PA-5124	
			Yellow	A3PJ-5125	A3PA-5125	
			Orange	A3PJ-5126	A3PA-5126	
		Vertical 2-split screen 	White	A3PJ-5131	---	
			Red	A3PJ-5132	---	
			Green	A3PJ-5133	---	
			Blue	A3PJ-5134	---	
			Yellow	---	---	
			Orange	A3PJ-5136	---	
		4-split screen 	White	A3PJ-5161	---	
			Red	A3PJ-5162	---	
Green	A3PJ-5163		---			
Blue	---		---			
Yellow	A3PJ-5165		---			
Orange	A3PJ-5166		---			
Colored plate for LED		Single screen 	White	A3PJ-5301	A3PA-5301	<ul style="list-style-type: none"> <li>• Keep mounted at all times. If the colored plate is lost or damaged, contact OMRON.</li> <li>• Use in accordance with coloring of the built-in LED.</li> <li>• For details on mounting, refer to page 25.</li> </ul>
			Red	A3PJ-5302	A3PA-5302	
			Green	A3PJ-5303	A3PA-5303	
			Yellow	A3PJ-5305	A3PA-5305	
			Orange	A3PJ-5306	A3PA-5306	
		Horizontal 2-split screen 	White	A3PJ-5321	A3PA-5321	
			Red	A3PJ-5322	A3PA-5322	
			Green	A3PJ-5323	A3PA-5323	
			Yellow	A3PJ-5325	A3PA-5325	
			Orange	A3PJ-5326	A3PA-5326	
		Vertical 2-split screen 	White	A3PJ-5331	---	
			Red	A3PJ-5332	---	
			Green	A3PJ-5333	---	
			Yellow	A3PJ-5335	---	
			Orange	A3PJ-5336	---	
		4-split screen 	White	A3PJ-5361	---	
			Red	A3PJ-5362	---	
			Green	A3PJ-5363	---	
			Yellow	A3PJ-5365	---	
			Orange	A3PJ-5366	---	
Light baffle		Horizontal 2-split screen		A3PJ-4302	A3PA-4302	<ul style="list-style-type: none"> <li>• Keep mounted at all times. If the light baffle is lost, contact OMRON.</li> <li>• Used in LED lamp-lighted models. Cannot be used in LED-lighted models.</li> </ul>
		Vertical 2-split screen		A3PJ-4303	---	
		Horizontal 3-split screen	Long axis	A3PJ-4304	---	
			Short axis	A3PJ-4305	---	
		Vertical 3-split screen	Long axis	A3PJ-4306	---	
			Short axis	A3PJ-4307	---	
		4-split screen	Long axis	A3PJ-4304	---	
Short axis	A3PJ-4308		---			
Legend plate		Transparent legend plate		A3PJ-5202	A3PA-5202	<ul style="list-style-type: none"> <li>• A transparent legend plate is mounted on the Pushbutton.</li> </ul>
		Milk-white legend plate		A3PJ-5201	A3PA-5201	
Cap		Transparent cap		A3PJ-5600	A3PA-5600	<ul style="list-style-type: none"> <li>• The surface is crimp-processed, so there is no reflection.</li> </ul>
		Crimp-processed transparent cap		A3PJ-5600-A	A3PA-5600-A	

## Ordering Information

### Tools

Name	Appearance	Classification	Model	Application precautions
Extractor		---	A3PJ-5080	<ul style="list-style-type: none"> <li>Use to extract components when replacing the Pushbutton.</li> </ul>

## Specifications

### Approved Standard Ratings

UL (File No. E41515), CSA (File No. LR45258)

Standard Load: 5 A at 125 VAC  
3 A at 250 VAC

Microload: 0.1 A at 125 VAC  
0.1 A at 30 VDC

Note: Certification has been obtained for the Switch Unit.  
For detailed information on individual products that have received certification, consult your supplier.

### CCC (GB14048.5)

Standard Load: 3 A at 250 VAC  
4 A at 30 VDC

Microload: 0.1 A at 125 VAC  
0.1 A at 30 VDC

### Ratings

#### Contact Ratings

##### Silver Alloy Contacts (for Standard Loads)

Rated voltage (V)	Non-inductive load (A)				Inductive load (A)			
	Resistive load		Lamp load		Inductive load		Motor load	
	NC	NO	NC	NO	NC	NO	NC	NO
125 VAC	5		0.7		3		1.3	
250 VAC	3		0.5		2		0.8	
8 VDC	5		2		4		3	
14 VDC	5		2		4		3	
30 VDC	4		2		3		3	
125 VDC	0.4		0.05		0.4		0.05	
250 VDC	0.2		0.03		0.2		0.03	

Note: 1. The above values are for steady-state currents.  
2. Inductive load: Power factor = 0.4; time constant = 7 ms.  
3. The lamp load has an inrush current of 10 times the steady-state current.  
4. The motor load has an inrush current of 6 times the steady-state current.

Standard testing condition

(1) Ambient temperature: 20 ± 2°C  
(2) Ambient humidity: 65 ± 5%RH  
(3) Operating frequency: 20 times/min.

##### Gold Alloy Contacts (for Microloads)

Rated voltage (V)	0.1 A at 30 VDC (resistive load); 0.1 A at 125 VAC (resistive load)
Minimum applicable load	1 mA at 5 VDC

## LED and Incandescent Lamp Ratings

### LED for LED-lighted Models

Model		A3PJ/M2PJ		A3PA/M2PA	
Applied voltage	Rated voltage	Rated current		Rated current	
		Single screen	2-split screen	Single screen	2-split screen
5 VDC±5%	5 VDC	80 mA	---	80 mA	---
12 VDC±5%	12 VDC	40 mA	---	40 mA	---
24 VDC±5%	24 VDC	20 mA	15 mA × 2	20 mA	13 mA × 2

### LED for Chameleon Models

Applied voltage	Rated voltage	Rated current	
		Green	Red
12 VDC±5%	12 VDC	26 mA	20 mA
24 VDC±5%	24 VDC	13 mA	10 mA

### Incandescent Lamp

Item		Standard lamp		Low-power lamp	
Applied voltage	Rated voltage	Rated current	Model	Rated current	Model
5 VDC	6 V	200 mA	SLL-06	100 mA	SLL-06H
12 VDC	14 V	80 mA	SLL-14	40 mA	SLL-14H
24 VDC	28 V	40 mA	SLL-28	25 mA	SLL-28H

### LED Lamp (for LED Lamp-lighted Models)

Type	Applied voltage	Rated voltage	Rated current	Model
DC only	5 VDC±5%	5 VDC	30 mA	SLL-05E□
	12 VDC±5%	12 VDC	15 mA	SLL-12E□
	24 VDC±5%	24 VDC	12.5 mA	SLL-24E□

## Characteristics

Operating frequency	Mechanical	120 operations/minute max. *1
	Electrical	30 operations/minute max.
Insulation resistance		100 MΩ min. (at 500 VDC)
Contact resistance	Standard load	40 mΩ max. (initial value)
	Microload	40 mΩ max. (initial value)
Dielectric strength	Between terminals of same polarity	1,000 VAC, 50/60 Hz for 1 minute *2
	Between terminals of different polarity	2,000 VAC, 50/60 Hz for 1 minute
	Between current-carrying metal part and ground	2,000 VAC, 50/60 Hz for 1 minute
	Between each terminal and non-current-carrying metal part	2,000 VAC, 50/60 Hz for 1 minute
	Between lamp terminals	1,000 VAC, 50/60 Hz for 1 minute *3
Vibration resistance	Malfunction	10 to 55 Hz, 1.5 mm double amplitude (1 ms max.)
Shock resistance	Destruction	500 m/s <sup>2</sup> max.
	Malfunction	200 m/s <sup>2</sup> max. (1 ms max.)
Life expectancy	Mechanical	Momentary operation models: 1,000,000 operations min. Alternate operation models: 200,000 operations min. (One operation consists of set and reset operations.)
	Electrical	100,000 operations min.
Weight		Approx. 30 g
Inrush current	NC	Silver contact: 10 A max.
	NO	Silver contact: 10 A max.
Ambient operating temperature		LED-lighted models: -10°C to 40°C (with no icing or condensation) Incandescent lamp-lighted models: -10°C to 50°C (with no icing or condensation)
Ambient operating humidity		35% to 85%RH
Ambient storage temperature		-25°C to 65°C
Degree of protection		IP40
Electric shock protection class		Class II
PTI (proof tracking index)		175
Pollution degree		3 (IEC947-5-1)

\*1. With alternate operation models, 60 operations/minute max. One operation cycle consists of set and reset operations.

\*2. 600 VAC for microloads.

\*3. With no incandescent lamp or LED lamp mounted.



## Specifications

### Operating Characteristics

Operating Characteristics	Model	A3PJ series		A3PA series		A3PT series	
		Momentary operation models	Alternate operation models	Momentary operation models	Alternate operation models	Momentary operation models	Alternate operation models
Operating force	OF max.	5.88 N	6.86 N	5.88 N	6.86 N	3.92 N	4.90 N
Releasing force	RF min.	0.39 N	0.29 N	0.39 N	0.29 N	0.39 N	0.29 N
Total travel	TT	Approx. 3.5 mm	Approx. 3.5 mm	Approx. 3.5 mm	Approx. 3.5 mm	Approx. 3.5 mm	Approx. 3.5 mm
Pretravel	PT max.	3 mm	3 mm	3 mm	3 mm	3 mm	3 mm
Lock travel alternate	LTA min.	---	0.5 mm	---	0.5 mm	---	0.5 mm

## Nomenclature

### Model Structure

Lighting method	LED-lighted models (LED is built-in.)		LED lamp-lighted models (LED lamp is not built-in.)			Incandescent lamp-lighted models (Incandescent lamp is not built-in.)			
	A3PJ	A3PA	A3PJ	A3PA	A3PT	A3PJ	A3PA	A3PT	
Screen patterns	Single screen 	Single screen 	Single screen 	Vertical 3-split screen 	Single screen 	Single screen 	Single screen 	Vertical 3-split screen 	Single screen 
	Horizontal 2-split screen 	Horizontal 2-split screen 	Horizontal 2-split screen 	Horizontal 3-split screen 	Horizontal 2-split screen 	Single screen 	Horizontal 2-split screen 	Horizontal 3-split screen 	Horizontal 2-split screen 
	Chameleon (3-color) 	Chameleon (3-color) 	Vertical 2-split screen 	4-split screen 	Horizontal 2-split screen 	Single screen 	Vertical 2-split screen 	4-split screen 	Horizontal 2-split screen 
						Single screen 			Single screen 

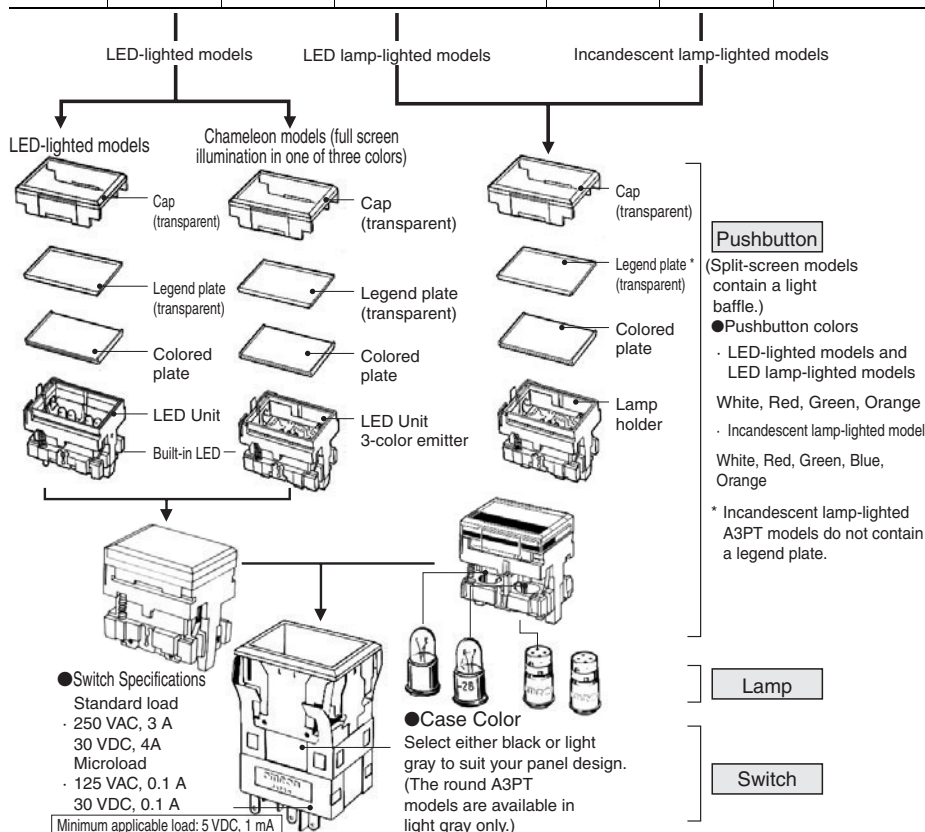

# Nomenclature

## A3P Lighting Method Diagram

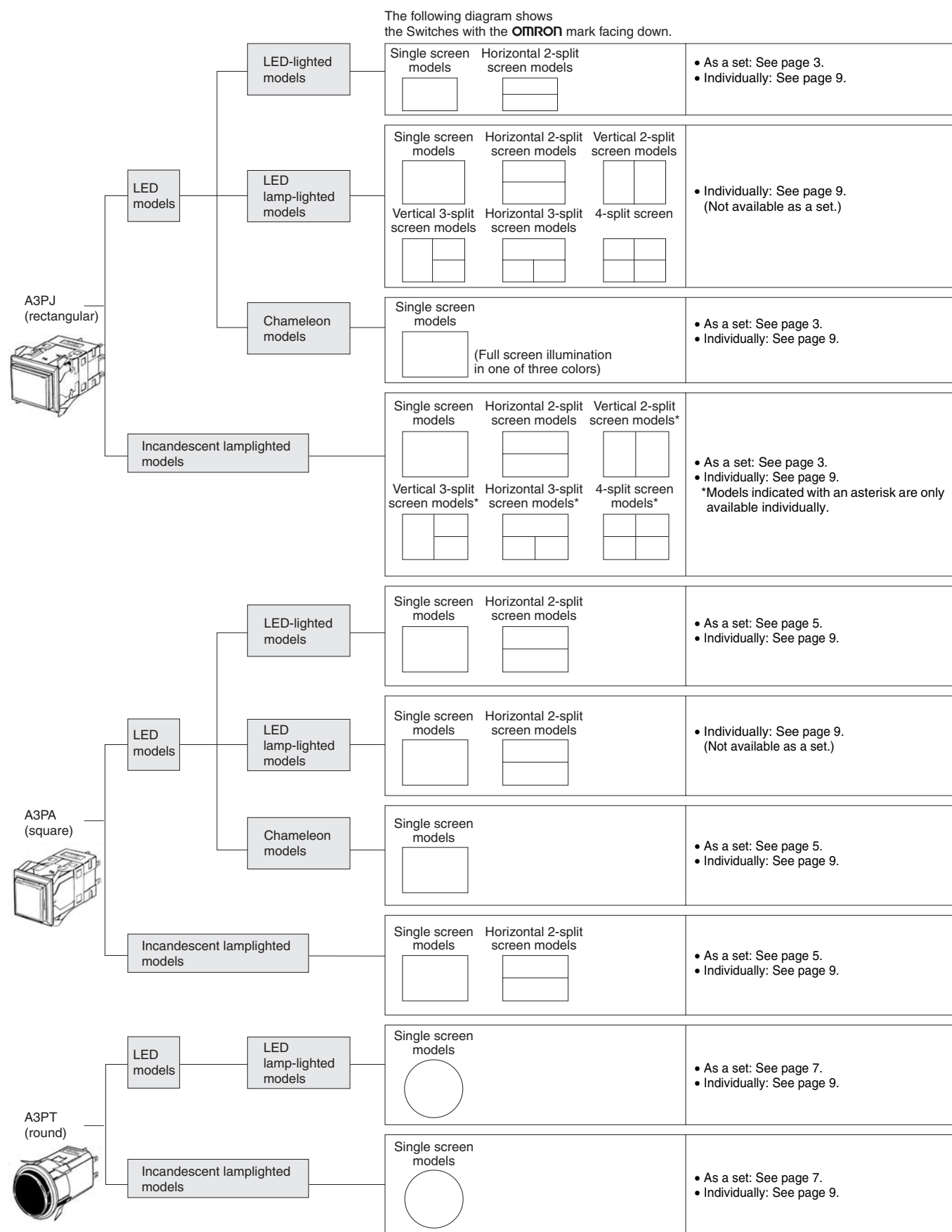

## Dimensions The Dimension shows 2-switch outputs.

(Unit: mm)

### A3PJ (Rectangular) Models

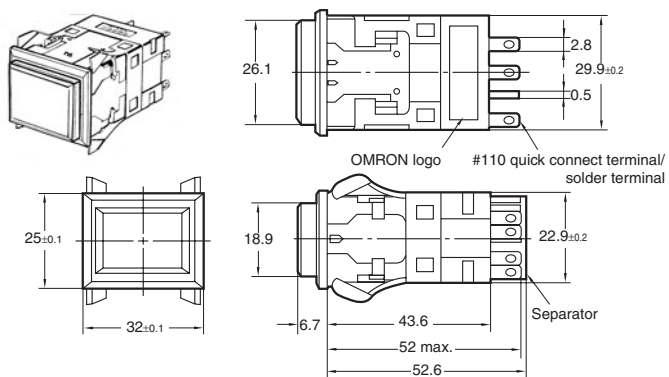

### A3PA (Square) Models

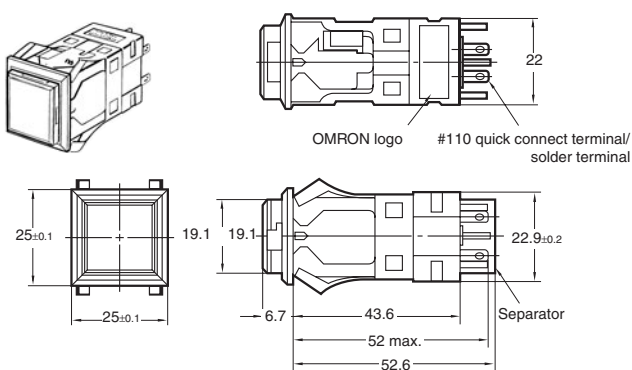

### A3PT (Round) Models

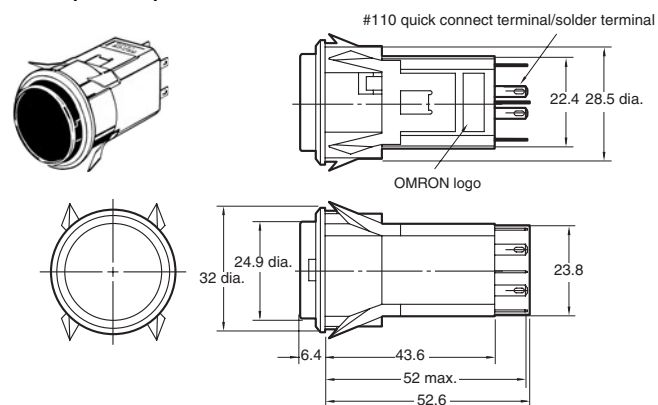













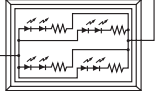

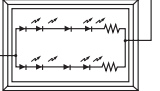

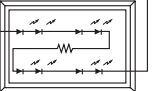

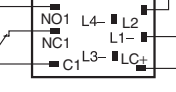
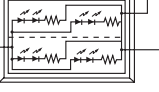
Note: The thickness of tab terminals #110 and solder terminals is 0.5 mm.

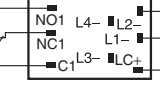
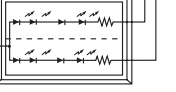
## Dimensions

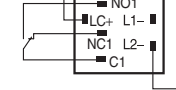
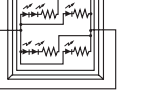
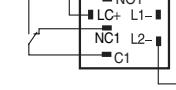
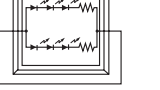
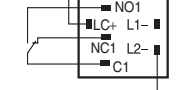
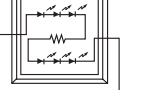
### Terminal connections

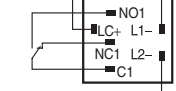
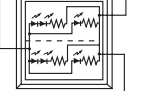
#### LED-lighted Models

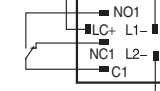
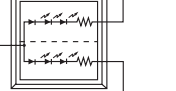
(The terminal arrangement diagram shows a 1-switch output. Connections to terminals from the lighting block are the same for 2 outputs.)

Rated voltage		5 VDC		12 VDC		24 VDC	
Model	Screen pattern						
A3PJ	Single screen 	Bottom view 	Top view 	Bottom view 	Top view 	Bottom view 	Top view 
	Horizontal 2-split screen 	Bottom view 	Top view 	Bottom view 	Top view 	Bottom view 	Top view 
A3PA	Single screen 	Bottom view 	Top view 	Bottom view 	Top view 	Bottom view 	Top view 
	2-split screen 	Bottom view 	Top view 	Bottom view 	Top view 	Bottom view 	Top view 

## Dimensions

### Incandescent Lamp-lighted/LED Lamp-lighted Models

(All are shown with the OMRON logo facing down. The terminal arrangements are the same as for the LED-lighted models.)

Output	Model	Rectangular A3PJ models	Square A3PA models	Round A3PT models
SPDT		<p>Bottom view      Top view</p> <p>Terminal arrangement      Lighting block</p>	<p>Bottom view      Top view</p> <p>Terminal arrangement      Lighting block</p>	<p>Bottom view      Top view</p> <p>Terminal arrangement      Lighting block</p>
		<p>Terminal arrangement      Lighting block</p>	<p>Terminal arrangement      Lighting block</p>	<p>Terminal arrangement      Lighting block</p>
PPDT		<p>Bottom view      Top view</p> <p>Terminal arrangement      Lighting block</p>	<p>Bottom view      Top view</p> <p>Terminal arrangement      Lighting block</p>	<p>Bottom view      Top view</p> <p>Terminal arrangement      Lighting block</p>
		<p>Terminal arrangement      Lighting block</p>	<p>Terminal arrangement      Lighting block</p>	<p>Terminal arrangement      Lighting block</p>
3PDT		<p>Bottom view      Top view</p> <p>Terminal arrangement      Lighting block</p>	---	---
		<p>Terminal arrangement      Lighting block</p>	---	---

### LED Chameleon Models

(The terminal arrangement diagram shows a 1-switch output. Connections to terminals from the lighting block are the same for 2 outputs.)

Rated voltage	24 VDC
<b>Rectangular A3PJ model</b> 	
<b>Square A3PA model</b> 	

### Terminal Arrangement and Coloring

#### Chameleon Models

Wiring	LC+	LC+	LC+
	L1-	L2-	L1- and L2- shorted
Coloring	Green	Red	Orange

## Dimensions

Panel Cutout (If using a Switch Guard or Seal Cover, refer to the panel cutout diagrams on page 23.)

### A3PJ (Rectangular) Models

Classification	Mounting design	Panel cutout	Remarks	
Flange mount models	Individual mounting (Horizontal)			Panel cutout spacing between rows of Units: 
	Multiple mounting (Horizontal)			
	Individual mounting (Vertical)			
	Multiple mounting (Vertical)			
Barrier mount models	Individual mounting (Horizontal)			For barrier mount models, refer to Accessories on page 13. Panel cutout spacing between rows of Units: (Dotted line indicates the position of each mounting barrier.) 
	Multiple mounting (Horizontal)			
	Individual mounting (Vertical)			
	Multiple mounting (Vertical)			

- Note: 1. n: Number of Units  
 2. Recommended panel thickness: 1 to 5 mm  
 3. Mount the panel before mounting the Switch Guard.  
 4. If the panel is to be finished (e.g., coated), make sure that the panel meets the specified dimensions after the coating.

### A3PA (Square) Models

Classification	Mounting design	Panel cutout	Remarks	
Flange mount models	Individual mounting			Panel cutout spacing between rows of Units: 
	Multiple mounting			
Barrier mount models	Individual mounting			Panel cutout spacing between rows of Units: (Dotted line indicates the position of each mounting barrier.) 
	Multiple mounting			

- Note: 1. n: Number of Units  
 2. Recommended panel thickness: 1 to 5 mm  
 3. Mount the panel before mounting the Switch Guard.  
 4. If the panel is to be finished (e.g., coated), make sure that the panel meets the specified dimensions after the coating.

### A3PT (Round) Models

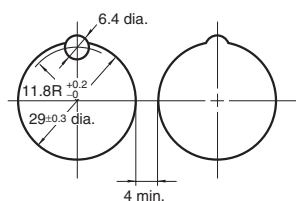

- Note: 1. Recommended panel thickness: 1 to 5 mm  
 2. If the panel is to be finished (e.g., coated), make sure that the panel meets the specified dimensions after the coating.

## Dimensions

### Accessory Mounting Dimensions

#### Legend Plate

#### Rectangular Models

#### A3PJ-5201/-5202

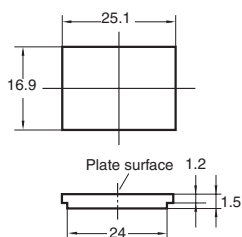

#### Square Models

#### A3PA-5201/-5202

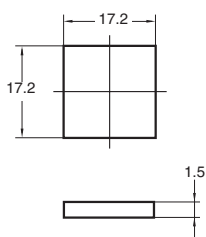

#### Extractor

#### A3PJ-5080

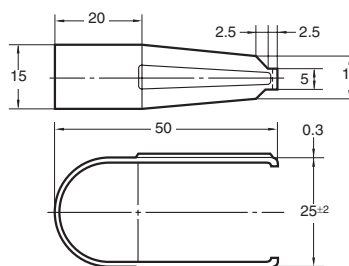

Note: Made from stainless steel.

### Socket-mounting Dimensions

#### Rectangular Models A3PJ (M2PJ)

#### Wire-wrap Terminal A3PJ-4101

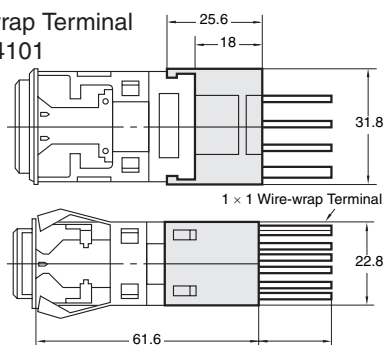

#### PCB Terminal A3PJ-4102

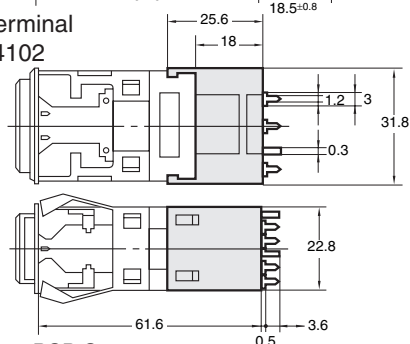

#### PCB Cutout (bottom view)

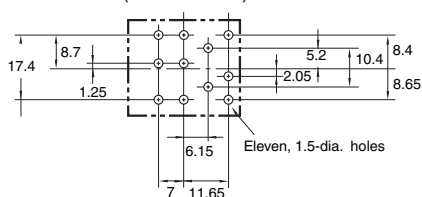

#### Solder Terminal A3PJ-4103

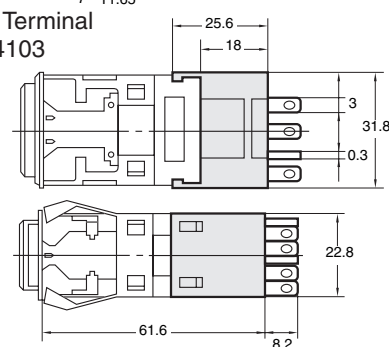

#### Terminal Hole Dimensions

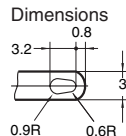

#### Square Models A3PA (M2PA)

#### Wire-wrap Terminal A3PA-4101

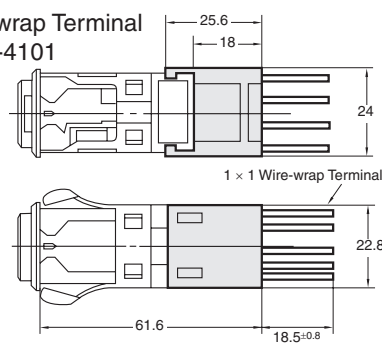

#### PCB Terminal A3PA-4102

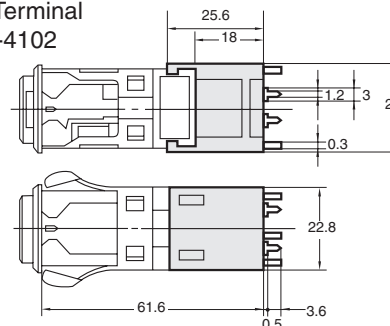

#### PCB Cutout (bottom view)

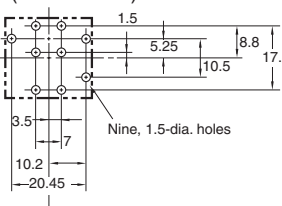

#### Solder Terminal A3PA-4103

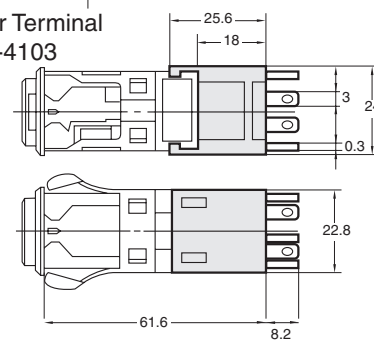

#### Terminal Hole Dimensions

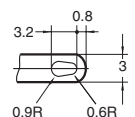

Note: PCB cutout dimensions show the switch mounted to the socket with the OMRON logo facing down.



**Dimensions**

**Switch and Guard Mounting Dimensions**

**Rectangular Models**

**A3PJN-5050 (Horizontal Mounting)**  
**A3PJN-5055 (Vertical Mounting)**

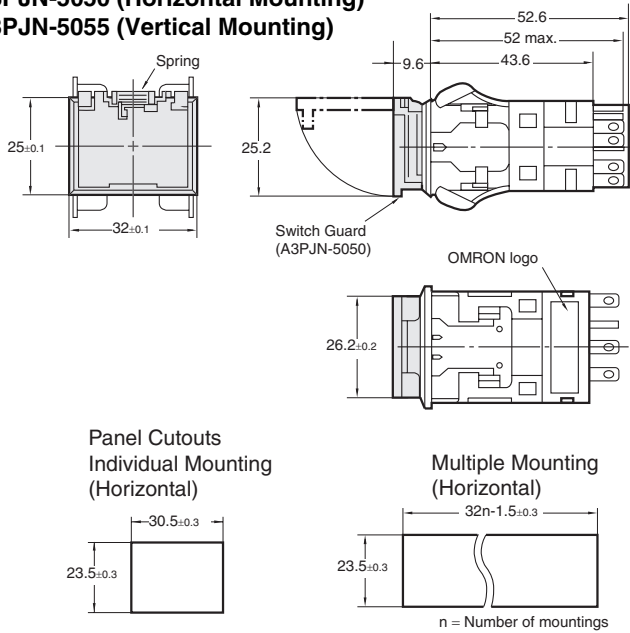

Note: Multiple vertical mounting is not possible.

**Square Models**

**A3PAN-5050 (Horizontal Mounting)**  
**A3PAN-5055 (Vertical Mounting)**

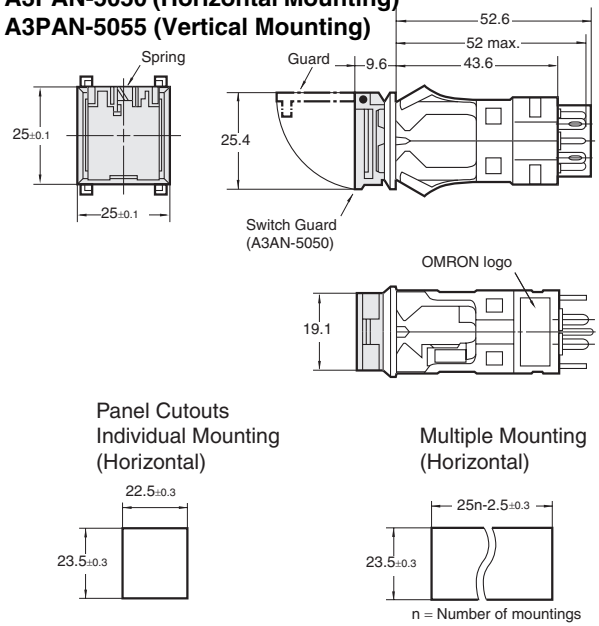

Note: Multiple vertical mounting is not possible.

**Seal Cover Mounting Dimensions**

**Rectangular Models**

**A3PJ-5060**

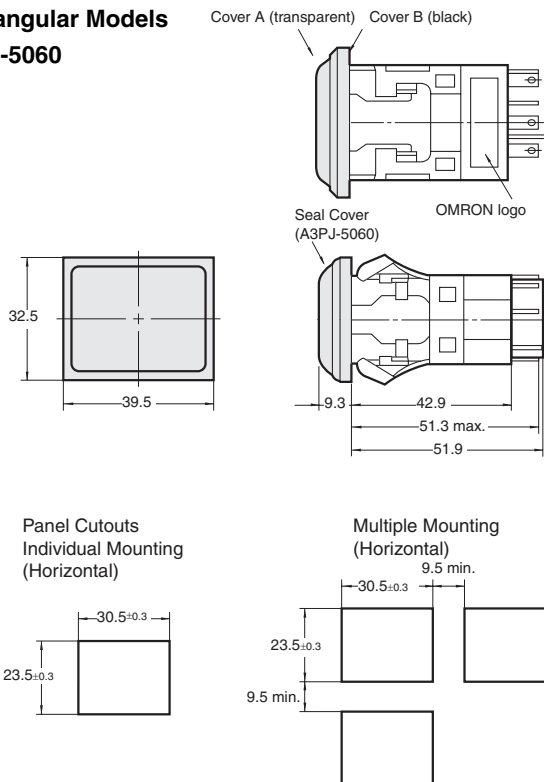

Note: 1. Recommended panel thickness: 1 to 5 mm  
 2. Unless otherwise specified, a tolerance of ± 0.4 mm applies to all dimensions.

**Square Models**

**A3PA-5060**

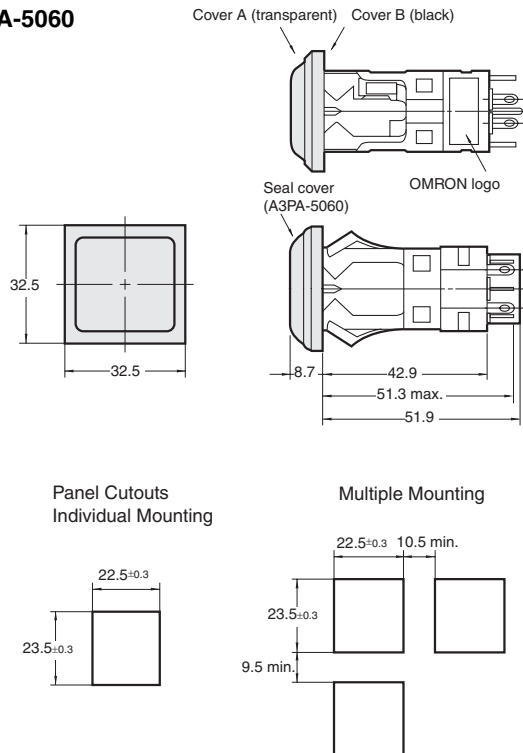

## Safety Precautions

Refer to *Safety Precautions for all Pushbutton Switches/Indicators*.

### Caution

Do not apply a voltage higher than the maximum rated operating voltage between the lamp terminals, as there is a risk that the incandescent lamp or LED will be damaged, and the Pushbutton will be ejected.



When replacing the incandescent lamp, first turn OFF the power supply, and then wait 10 minutes before performing replacement, as the lamp is still hot immediately after the power is turned OFF, so there is a risk of burns.



### Precautions for Correct Use

1. Always make sure that the power is turned OFF before mounting, removing, or wiring the Switch, or performing maintenance. Electric shock or fire may occur.
2. After wiring the Switch, make sure that there is a suitable isolation distance.

#### Wiring

- Solder quickly and correctly at 350°C max and for 3 s or less. Wait for one minute after soldering before exerting any external force on the solder.

#### Operating Environment

- Do not use in locations that are subject to dust, oil, or metal filings as these may penetrate the interior of the Switch and cause malfunction.

#### LED (for VDC)

- Check the terminal polarity when wiring.
- The rated voltage is shown on the plate on the back of the lighting unit, so be sure to use within the voltage shown.
- An LED current-limiting resistor is built in, so there is no need to mount an external resistor.

#### Incandescent Lamp

- Apply 80% of the rated voltage (operating voltage) to the incandescent lamp to improve life expectancy and incandescence.

#### Character Plate (Character Film)

- If preparing the character plate separately, use a heat-resistant film with a thickness of 0.1 to 0.3 mm.

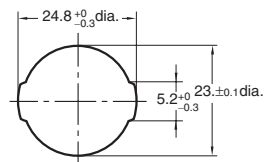
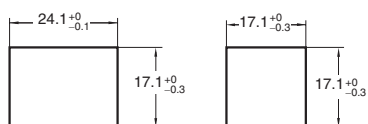

#### Using Microloads

- Using a standard load switch when a microload circuit is opened or closed may cause contact failure on the contacts. Use the switch within the operating range. (Refer to the diagram below.) Even when using microload models within the operating range shown below, if inrush current occurs when the contact is opened or closed, it may cause the contact surface to become rough, and so decrease life expectancy. Therefore, insert a contact protection circuit where necessary. The minimum applicable load is the N-level reference value. This value indicates the malfunction reference level for the reliability level of 60% ( $\lambda 60$ ) (conforming to JIS C5003). The equation,  $\lambda 60 = 0.5 \times 10^{-6}/\text{time}$  indicates that the estimated malfunction rate is less than 1/2,000,000 with a reliability level of 60%.

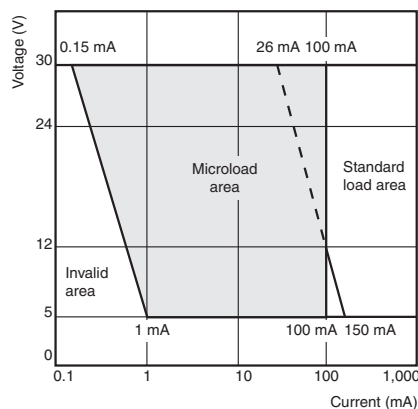

#### Others

- If the panel is to be finished (e.g., coated), make sure that the panel meets the specified dimensions after the coating.

## Assembly/Disassembly

### A3PJ/M2PJ (Rectangular Models), A3PA/M2PA (Square Models)

#### Locking/Unlocking Positive Cap Lock Mechanism

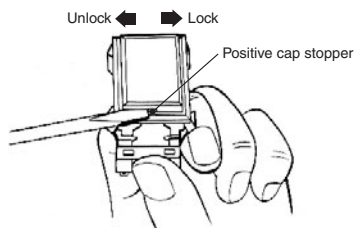

#### Mounting Pushbutton

- Be sure to mount the Pushbutton with the correct orientation. Align the groove on the Pushbutton, the projections in the Switch, and the LED contact piece before pushing the Pushbutton into the Switch.
- When dismantling the Pushbutton, use the Extractor (A3PJ-5080) for easy dismantling.

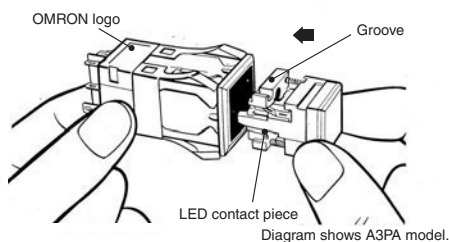

#### Removing/Mounting Cap

Insert the A3PA from the open side into the theft-prevention stopper.

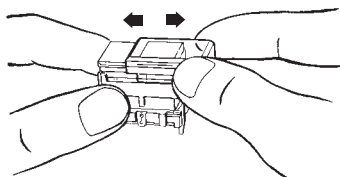

#### Mounting Colored Plate

Place the colored plate on the plunger case with the dull side of the colored plate facing downward.

With A3PJ split-screen models, be sure that the projections on the upper surface of the colored plate face outward. For the A3PA, make sure that the flat plate is facing upwards.

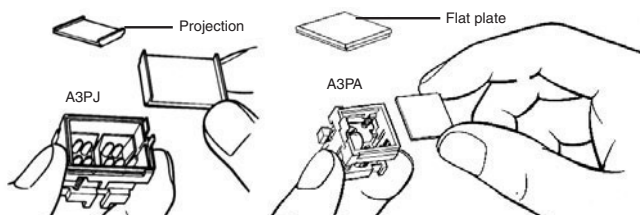

#### Mounting Character Plate (Character Frame) and Legend Plate

Mount the legend plate for the A3PJ under the layered surfaces and mount the cap, as shown below.

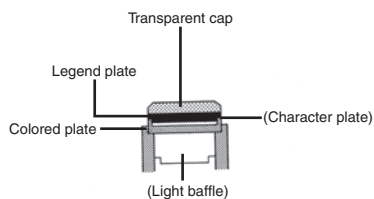

#### Mounting and Replacing LED and Incandescent Lamps

If using an A3PA (square) model with one incandescent lamp, insert the lamp in the center hole.

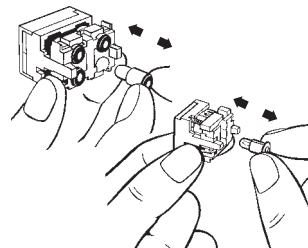

Note: Built-in LEDs cannot be replaced.

#### LED Rated Voltage Display (LED Models Only)

The LED rated voltage is shown between the built-in resistors on the back of the lighting unit. Use within a range of  $\pm 5\%$ .

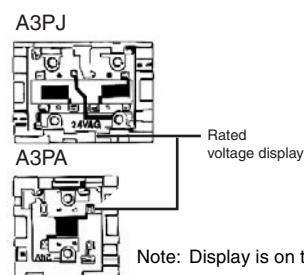

Note: Display is on the back.

#### Mounting Switch onto Panel

- **Individual Mounting and Barrier Mounting**  
When mounting the Switch, push it into the panel cutout from the front of the mounting panel by holding it with the logo mark "OMRON" facing downward.
- **Multiple Barrier Mounting (A3PJ)**  
When mounting a number of Switches in line on the panel, link the Switches with spacing barriers in between, attach mounting barriers at both sides of this block of Switches and, pushing in on the mounting barriers at the side, insert the Switches into the panel cutout together.

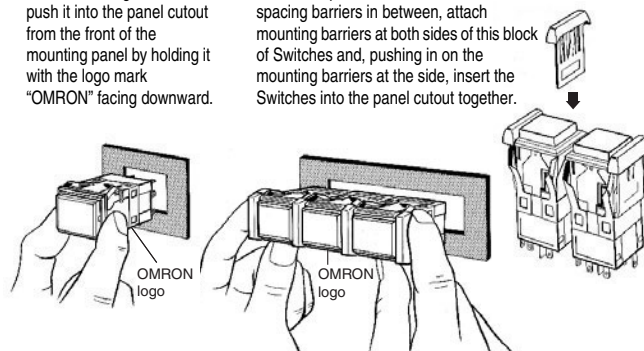

#### Mounting Barriers

Mount each part by pushing it in the direction of the arrow shown in the corresponding illustration below.

Barrier mounting

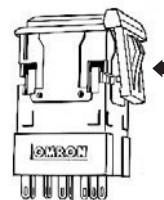

### Mounting Seal Cover

After mounting the seal cover onto the flange of the Switch, push the Switch into the panel cutout.

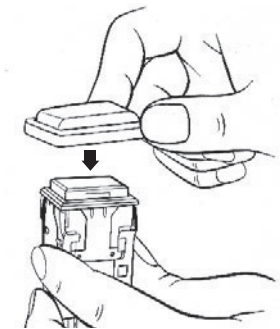

### Inscribing the Legend Plate

- Inscribe the legend plate to a depth of 0.5 mm max.
- The legend plate is made from polycarbonate resin. To coat the legend plate, use an alcohol-based coating such as melamine, phthalic acid, or acrylic.

### Maintenance Lock

1. First, when you insert the transparent lens while pressing the center, the maintenance lock mechanism will be activated, and the Switch will not operate. Lamp replacement and other maintenance can be performed without turning OFF the power supply to devices and equipment. Use an insertion force of 4 kg.

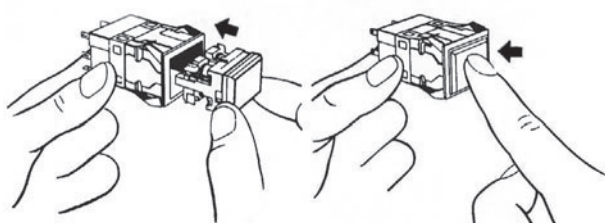

2. Next, when you remove your finger from the Switch, the lock will be released.

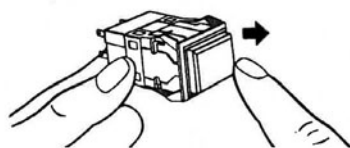

3. The Switch will start to operate when the lighting unit is pressed the second time.

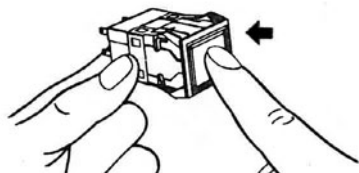

## Read and Understand This Catalog

Please read and understand this catalog before purchasing the products. Please consult your OMRON representative if you have any questions or comments.

## Warranty and Limitations of Liability

### WARRANTY

OMRON's exclusive warranty is that the products are free from defects in materials and workmanship for a period of one year (or other period if specified) from date of sale by OMRON.

OMRON MAKES NO WARRANTY OR REPRESENTATION, EXPRESS OR IMPLIED, REGARDING NON-INFRINGEMENT, MERCHANTABILITY, OR FITNESS FOR PARTICULAR PURPOSE OF THE PRODUCTS. ANY BUYER OR USER ACKNOWLEDGES THAT THE BUYER OR USER ALONE HAS DETERMINED THAT THE PRODUCTS WILL SUITABLY MEET THE REQUIREMENTS OF THEIR INTENDED USE. OMRON DISCLAIMS ALL OTHER WARRANTIES, EXPRESS OR IMPLIED.

### LIMITATIONS OF LIABILITY

OMRON SHALL NOT BE RESPONSIBLE FOR SPECIAL, INDIRECT, OR CONSEQUENTIAL DAMAGES, LOSS OF PROFITS OR COMMERCIAL LOSS IN ANY WAY CONNECTED WITH THE PRODUCTS, WHETHER SUCH CLAIM IS BASED ON CONTRACT, WARRANTY, NEGLIGENCE, OR STRICT LIABILITY.

In no event shall the responsibility of OMRON for any act exceed the individual price of the product on which liability is asserted.

IN NO EVENT SHALL OMRON BE RESPONSIBLE FOR WARRANTY, REPAIR, OR OTHER CLAIMS REGARDING THE PRODUCTS UNLESS OMRON'S ANALYSIS CONFIRMS THAT THE PRODUCTS WERE PROPERLY HANDLED, STORED, INSTALLED, AND MAINTAINED AND NOT SUBJECT TO CONTAMINATION, ABUSE, MISUSE, OR INAPPROPRIATE MODIFICATION OR REPAIR.

## Application Considerations

### SUITABILITY FOR USE

OMRON shall not be responsible for conformity with any standards, codes, or regulations that apply to the combination of products in the customer's application or use of the products.

At the customer's request, OMRON will provide applicable third party certification documents identifying ratings and limitations of use that apply to the products. This information by itself is not sufficient for a complete determination of the suitability of the products in combination with the end product, machine, system, or other application or use.

The following are some examples of applications for which particular attention must be given. This is not intended to be an exhaustive list of all possible uses of the products, nor is it intended to imply that the uses listed may be suitable for the products:

- Outdoor use, uses involving potential chemical contamination or electrical interference, or conditions or uses not described in this catalog.
- Nuclear energy control systems, combustion systems, railroad systems, aviation systems, medical equipment, amusement machines, vehicles, safety equipment, and installations subject to separate industry or government regulations.
- Systems, machines, and equipment that could present a risk to life or property.

Please know and observe all prohibitions of use applicable to the products.

NEVER USE THE PRODUCTS FOR AN APPLICATION INVOLVING SERIOUS RISK TO LIFE OR PROPERTY WITHOUT ENSURING THAT THE SYSTEM AS A WHOLE HAS BEEN DESIGNED TO ADDRESS THE RISKS, AND THAT THE OMRON PRODUCTS ARE PROPERLY RATED AND INSTALLED FOR THE INTENDED USE WITHIN THE OVERALL EQUIPMENT OR SYSTEM.

### PROGRAMMABLE PRODUCTS

OMRON shall not be responsible for the user's programming of a programmable product, or any consequence thereof.

## Disclaimers

### CHANGE IN SPECIFICATIONS

Product specifications and accessories may be changed at any time based on improvements and other reasons.

It is our practice to change model numbers when published ratings or features are changed, or when significant construction changes are made. However, some specifications of the products may be changed without any notice. When in doubt, special model numbers may be assigned to fix or establish key specifications for your application on your request. Please consult with your OMRON representative at any time to confirm actual specifications of purchased products.

### DIMENSIONS AND WEIGHTS

Dimensions and weights are nominal and are not to be used for manufacturing purposes, even when tolerances are shown.

### PERFORMANCE DATA

Performance data given in this catalog is provided as a guide for the user in determining suitability and does not constitute a warranty. It may represent the result of OMRON's test conditions, and the users must correlate it to actual application requirements. Actual performance is subject to the OMRON Warranty and Limitations of Liability.

### ERRORS AND OMISSIONS

The information in this document has been carefully checked and is believed to be accurate; however, no responsibility is assumed for clerical, typographical, or proofreading errors, or omissions.

2012.9

In the interest of product improvement, specifications are subject to change without notice.

**OMRON Corporation**  
Industrial Automation Company

<http://www.ia.omron.com/>

(c)Copyright OMRON Corporation 2012 All Right Reserved.