

Best Selection

Fiber Sensor Best Selection Catalog

Measurement Judgement Presence



Start with Smart!

Easily select the most reliable Fiber Unit for your detection conditions.



NEW

Smart Fiber Amplifier Units
E3X-HD



NEW

Communications Units
E3X-CRT E3X-ECT



Fiber Sensor Features	2 Page
Selection Guide	4 Page
Fiber Units	
Standard Installation	6 Page
Saving Space	14 Page
Beam Improvements	18 Page
Transparent Objects	32 Page
Environmental Immunity	36 Page
Applications	46 Page
Installation Information	56 Page
Fiber Amplifiers, Communications Unit, and Accessories	60 Page
Technical Guide and Precautions	78 Page
Model Index	84 Page

Easy

Optimal Fiber Sensor for additional Fiber Units for various Installation Conditions,

“Mounts Anywhere”

Wide Variety

Variouly-shaped, compact heads allow installation in any small space.

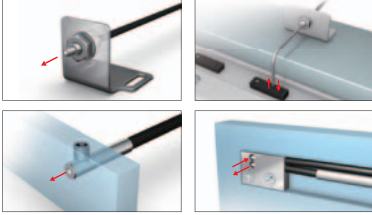

Suitable for Harsh Environments

Fiber Units are available for various installation conditions and can be installed as is, even in harsh environments.

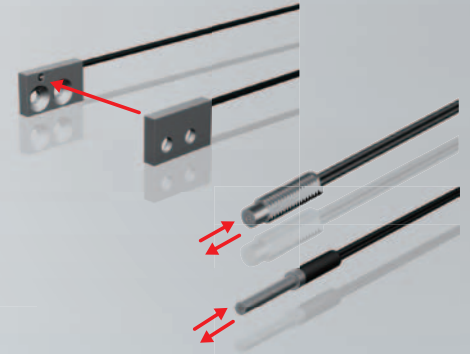
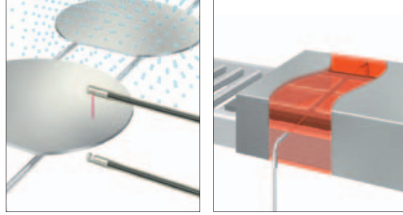

“Easy and Optimum Settings for Anyone”

Universal Design

Anyone can easily set it regardless of the language, the age or the skill level.



Smart Tuning

Automatically find the optimum settings with the single button.

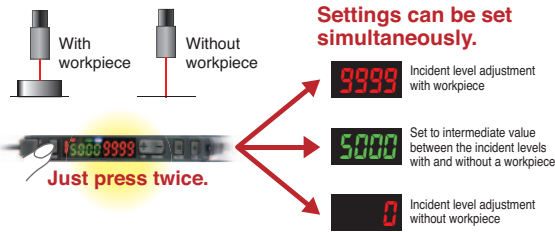

NEW

Smart Fiber Amplifier Units (Advanced Models)

E3X-HD

60, 64 Page

“Smooth Wiring and Setting”

Joining Installation

No wiring is required to join Fiber Amplifier Units together.

Simple Communications

Setting changes and read-out are easy with the communications.



“Simplified Setup”

Minimum Required Settings Menu

A simplified menu specifically for detection settings and one digital display eliminate unnecessary settings and reduce the possibility of setting errors.

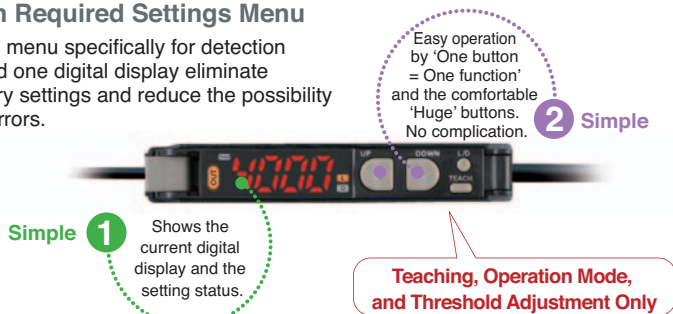

Simple Fiber Amplifier Units (Simple Models)

E3X-SD

61, 72 Page

Fiber

“Easy” and “Stable” for

installation when starting production.

Fiber Amplifier Units with easy optimum setting

Stable

Fiber Units

E32

06
Page



“Extremely Stable Detection, Essentially No Maintenance”

Highest Power in Its Class

More precise detection for low-reflective / large workpieces compare to the conventional models.

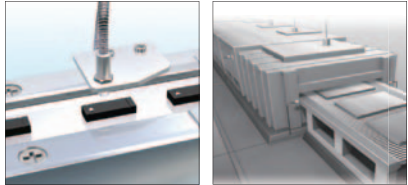

Smart Power Control

Long-term stable detection with no maintenance.

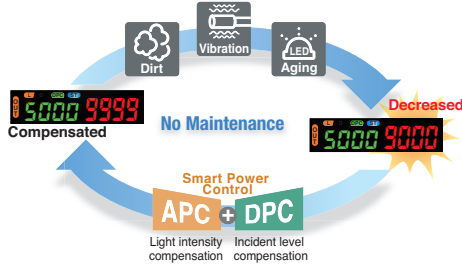

NEW

Communications Units

E3X-CRT/ECT

61, 70
Page



Basic Features of Fiber Sensors

The Amplifier Units can be installed in one place together regardless of the number of the detection parts.



Digital display achieves visual control and quantitative control.

Conventional Photoelectric Sensor with Built-in Amplifier

Set the threshold by a sensitivity adjuster / Check the operation by an indicator.



- Ambiguous standard (e.g., 3/4 turn of adjuster)
- Indicator does not show the present value.

Fiber Sensor

Quantitative control over threshold settings with a digital display.



- The reference value can be set numerically for easier specification.
- Easily perceivable present value.

Ideal for narrow spaces or for detecting minute objects.

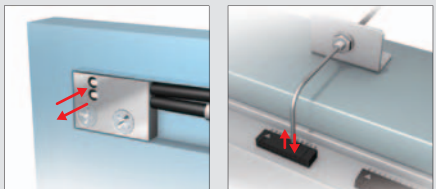

Sensor

Minimal Cost Process.

Select of new adoption product
Selection by **Category**

STEP 1

Select a Fiber Unit.

Select a category.

Fiber Unit Index

05 Page

Select a model.

Category Pages 06 to 59 Page

STEP 2

Select a Fiber Amplifier Unit and Communications Unit.

60 Page

STEP 3

Select Accessories of Fiber Amplifier Unit

63 Page

Before Selecting Fiber Units

The Fiber Units specifications give the sensing distance when the Fiber Unit and Fiber Amplifier Unit is combined. Check the Fiber Amplifier Unit series for easier selection.

<Specifications on Each Fiber Unit Category Page>

h-beam Fiber Units							
Appearance (mm)	Bending radius of cable	Sensing distance (mm)			Optical axis diameter (minimum sensing object)	Models	07 Dimension
		Simple Fiber Amplifier Units (Simple Models) E3X-SD	Smart Fiber Amplifier Units (Advanced Models) E3X-HD				
	Flexible, R1	530	2,000	ST : 1,000	1 dia. (5 μm dia.)	E32-T11N 2M	07
		560	700	SHS : 280		E32-T11R 2M	

Even under the sensing distances has the following modes and response times.

Fiber Amplifier Unit Series

		Simple Fiber Amplifier Unit E3X-SD Series	Smart Fiber Amplifier Unit E3X-HD Series
Digital displays		Incident level (1 display, threshold display when setting)	Incident level + threshold (2 displays)
Functions	Standard Models	Advanced Models	
	SPC (Automatic Compensation)	None	Provided
	Timer	None	ON, OFF and One shot
	Communications Unit	Unsupported	Supported (CompoNet or EtherCAT)
Mutual interference prevention		5 Units	10 Units
Response time		200 μs (Fixed)	50μs (55μs)/250μs/1ms/16ms (Default: 250 μs)
Page listings	Ordering Information	62 Page	
	Ratings and specifications	72 Page	64 Page (Communications Unit: 70 Page)
	Dimensions	73 Page	64 and 65 Page (Communications Unit: 71 Page)

Selection by **Model**

STEP 1

Search for the page in the model index.

84 Page

STEP 2

Search for the model on the corresponding pages.

Each Page

Threaded

Cylindrical

Flat

Sleeved

Small Spot

High Power

Narrow view

BGS

Retro-reflective

Limited-reflective

Chemical-resistant, Oil-resistant

Bending

Heat-resistant











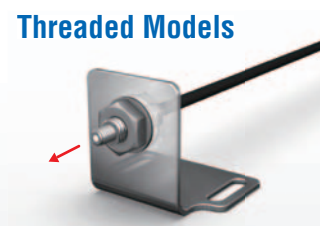
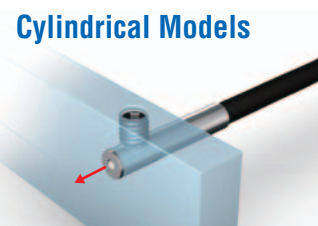

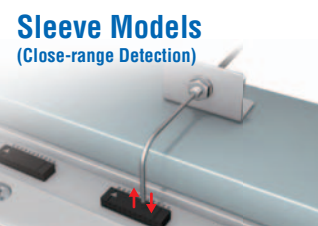

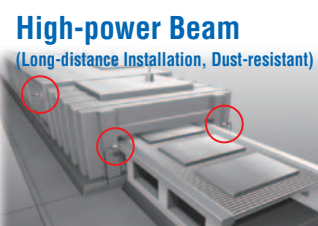
Area Detection

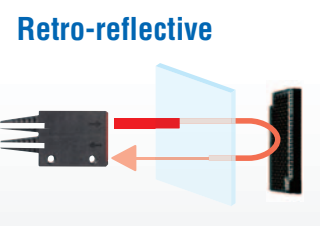
Liquid-level

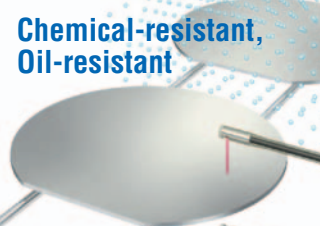
Vacuum

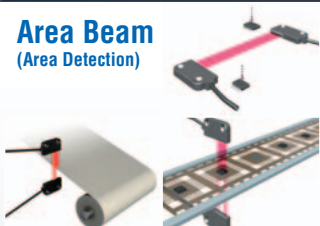
FPD, Semi, Solar

Fiber Unit Index

Standard Installation		Saving Space	
Threaded Models  Standard screw-type installation. The Fiber Units is mounted into a drilled hole and secured with nuts. 06 Page	Cylindrical Models  Ideal for installation in narrow spaces. The Fiber Unit is secured with a set screw. 10 Page	Flat Models  Mount directly in limited spaces without using special mounting brackets. 14 Page	Sleeve Models (Close-range Detection)  Suitable for close-range detection. Ideal for detecting minute objects in areas with limited space. 16 Page
Beam Improvements			
Small-Spot, Reflective (Minute Object Detection)  Small-spot to accurately detect small objects. 18 Page	High-power Beam (Long-distance Installation, Dust-resistant)  Suitable for detection on large equipment, of large objects, and in environments with airborne particles. 22 Page	Narrow View (Detection Across Clearance)  The Fiber Unit emit a non-spreading beam to prevent false detection of light reflected off surrounding objects. 28 Page	Detection without Background Interference  Detect only objects in the sensing range, and not in the background. 30 Page
Transparent Object Detection			
Retro-reflective  Detect transparent objects reliably because the beam passes through the object twice, resulting in greater light interruption. 32 Page	Limited-reflective (Glass Detection)  The limited-reflective optical system provides stable detection of specular reflective glass. 34 Page		
Environmental Immunity			
Chemical-resistant, Oil-resistant  Made from materials that are resistant to various oils and chemicals. 36 Page	Bending-resistant, Disconnection-resistant  Resistant to repeated bending on moving parts and breaking from snagging or shock. 38 Page	Heat-resistant  Can be used in high-temperature environments at up to 400°C. 42 Page	
Special Applications			
Area Beam (Area Detection)  Detect across areas for meandering materials or falling workpieces whose position vary. 46 Page	Liquid-level Detection  Detect only liquid when being mounted on tubes or in liquid. 48 Page	Vacuum-resistant  Can be used under high vacuums of up to 10 ⁻⁵ Pa. 50 Page	FPD, Semiconductors, and Solar Cells  Designed specifically to reliably detect glass substrates and wafers. 52 Page

Fiber Sensor Features

Selection Guide

Fiber Units

Threaded	Standard Installation
Cylindrical	
Flat	Saving Space
Sleeved	
Small Spot	Beam Improvements
High Power	
Narrow view	
BGS	
Retro-reflective	Transparent Objects
Limited-reflective	
Chemical-resistant, Oil-resistant	Environmental Immunity
Bending	
Heat-resistant	
Area Detection	Applications
Liquid-level	
Vacuum	
FPD, Semi, Solar	

Installation Information

Fiber Amplifiers, Communications Unit, and Accessories

Technical Guide and Precautions

Model Index

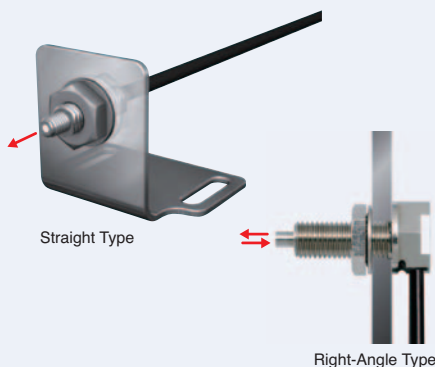

- Standard configuration. These Fiber Units are mounted into a hole drilled in a bracket and secured with nuts.
- The Right-angle Model prevents snagging on the cable because the cable runs along the mounting surface.

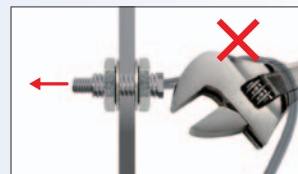
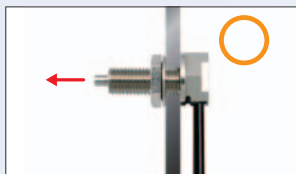

Specifications

Through-beam Fiber Units

Sensing direction	Size	Appearance (mm)	Bending radius of cable	Sensing distance (mm)			Optical axis diameter (minimum sensing object)	Models	07 Page Dimensions No.
				Simple Fiber Amplifier Units (Simple Models) E3X-SD	Smart Fiber Amplifier Units (Advanced Models) E3X-HD				
					GIGA	HS			
Right-Angle	M4		Flexible, R1	530	2,000	ST : 1,000	1 dia. (5 μm dia.)	E32-T11N 2M	07-A
Straight				560	700	SHS: 280			

Note 1. The mode of E3X-HD that is given under the sensing distances has the following mode names and response times.
 GIGA: GIGA Power Mode (16 ms), HS: High-speed Mode (250 μs), ST: Standard Mode (1 ms), and SHS: Super-high-speed Mode (NPN output and E3X-HD0: 50 μs, PNP output: 55 μs)
Note 2. The values for the minimum sensing object are representative values that indicate values obtained in Standard Mode with the sensing distance and sensitivity set to the optimum values.

Dimensions

Installation Information → 58 Page

Through-beam Fiber Units (Set of 2)

07-A E32-T11N 2M (Free Cutting)

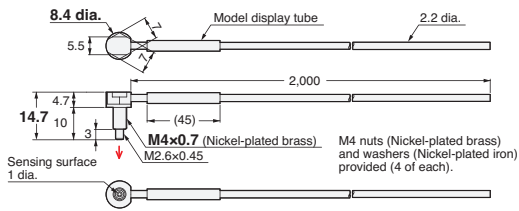

07-B E32-T11R 2M (Free Cutting)

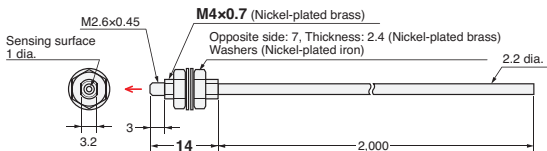

- Reference Information for Model Selection -

Features of the Right-angle Type

- Cable is less prone to snagging.
- Cable runs along the mounting surface for less space compared with straight Fiber Units.
- The nut is attached to the Fiber Unit to reduce installation work.

What Is "Flexible" Fiber?

The flexible fiber has a small bending radius for easy routing without easily breaking. It is easy to use because the cable can be bent without significantly reducing light intensity.

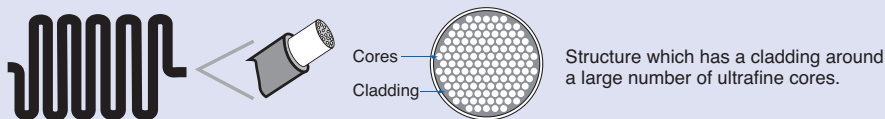

And

Long-distance Sensing Applications

A separate Lens Unit can be attached to extend the sensing distance.

→ 24 Page

Breaking Due to Snagging or Shock

The Fiber Unit can be protected from breaking with stainless steel spiral tube.

→ 38 Page (Only E32-T11R 2M)

Fiber Sensor
Features

Selection
Guide

Fiber Units

Threaded

Cylindrical

Flat

Sleeved

Small Spot

High Power

Narrow
view

BGS

Retro-
reflective

Limited-
reflective

Chemical-
resistant,
Oil-resistant

Bending

Heat-
resistant

Area
Detection

Liquid-level

Vacuum

FPD,
Semi,
Solar

Standard Installation

Saving Space

Beam Improvements

Transparent Objects

Environmental Immunity

Applications

Installation
Information

Fiber Amplifiers,
Communications
Unit, and
Accessories

Technical
Guide and
Precautions

Model Index

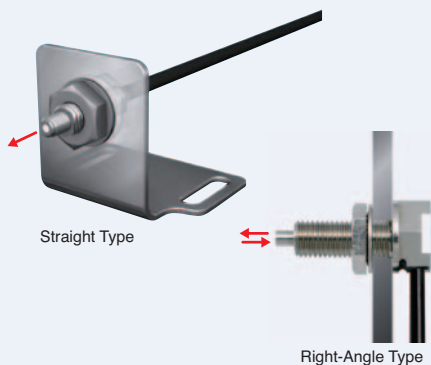

- Standard configuration. These Fiber Units are mounted into a hole drilled in a bracket and secured with nuts.
- The Right-angle Model prevents snagging on the cable because the cable runs along the mounting surface.

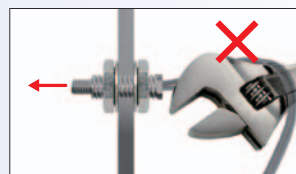
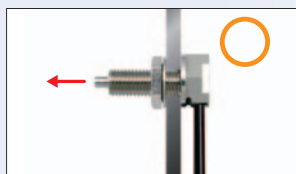

Specifications

Reflective Fiber Units

Sensing direction	Size	Appearance (mm)	Bending radius of cable	Sensing distance (mm)			Optical axis diameter (minimum sensing object)	Models	09 Page Dimensions No.
				Simple Fiber Amplifier Units (Simple Models) E3X-SD	Smart Fiber Amplifier Units (Advanced Models) E3X-HD				
					GIGA	HS			
Right-Angle	M3		Flexible, R4	25	110 46	ST : 50 SHS: 14	(5 μm dia.)	E32-C31N 2M	09-A
	M6			170	780 320	ST : 350 SHS: 100		E32-C11N 2M	09-B
Straight	M3		Flexible, R1	30	140 40	ST : 60 SHS: 16	(5 μm dia.)	E32-D21R 2M	09-C
			R25	80	330 100	ST : 150 SHS: 44		E32-C31 2M	09-D
		R10	80	330 100	ST : 150 SHS: 44	E32-C31M 1M <i>NEW</i>		09-E	
	M4		Flexible, R1	30	140 40	ST : 60 SHS: 16		E32-D211R 2M	09-F
	M6			180	840 240	ST : 350 SHS: 100		E32-D11R 2M	09-G
			R25	300	1,400 400	ST : 600 SHS: 180		E32-CC200 2M	09-H

Note 1. The mode of E3X-HD that is given under the sensing distances has the following mode names and response times.
 GIGA: GIGA Power Mode (16 ms), HS: High-speed Mode (250 μs), ST: Standard Mode (1 ms), and SHS: Super-high-speed Mode (NPN output and E3X-HD0: 50 μs, PNP output: 55 μs)
Note 2. The values for the minimum sensing object are representative values that indicate values obtained in Standard Mode with the sensing distance and sensitivity set to the optimum values.
Note 3. The sensing distances for Reflective Fiber Units are for white paper.

Dimensions

Installation Information → 56 Page

Reflective Fiber Units

09-A E32-C31N 2M (Free Cutting)

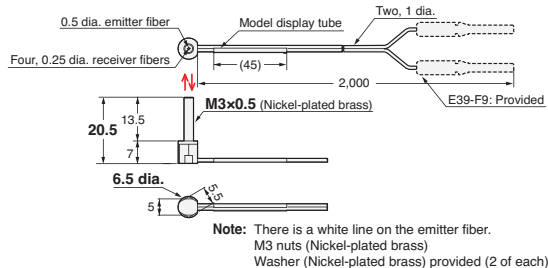

09-B E32-C11N 2M (Free Cutting)

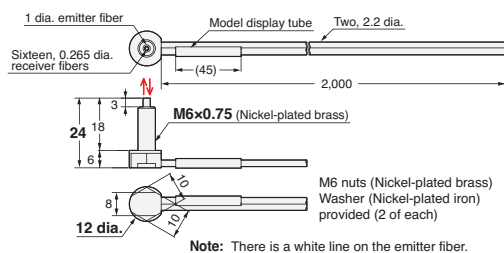

09-C E32-D21R 2M (Free Cutting)

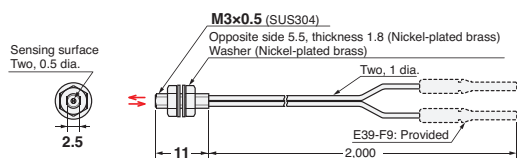

09-D E32-C31 2M (Free Cutting)

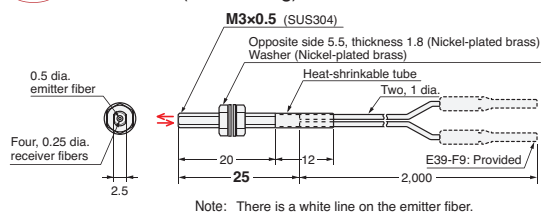

09-E E32-C31M 1M (Free Cutting)

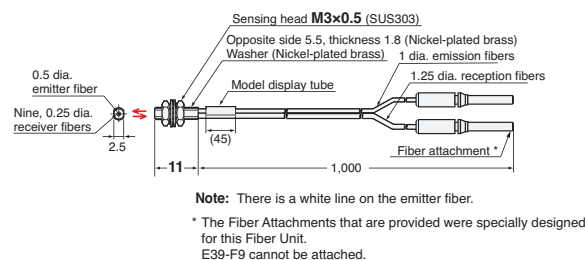

09-F E32-D211R 2M (Free Cutting)

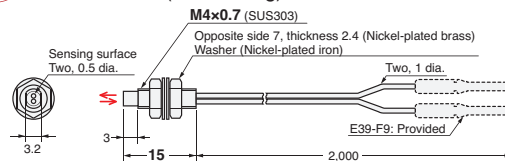

09-G E32-D11R 2M (Free Cutting)

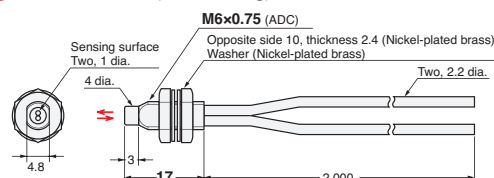

09-H E32-CC200 2M (Free Cutting)

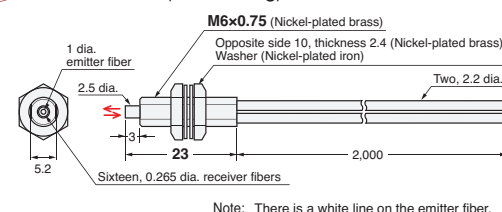

- Reference Information for Model Selection -

Features of Coaxial Reflective Type

These Fiber Units offer better detection of small objects at close distances (of 2 mm or less) than Standard Reflective Fiber Units. They also detect glossy surfaces more reliably than Standard Reflective Fiber Units, even if the surface is tilted. The receiver fibers are arranged around the emitter fiber as shown below.

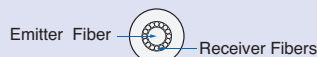

Features of the Right-angle Type

- Cable is less prone to snagging.
- Cable runs along the mounting surface for less space compared with straight Fiber Units.
- The nut is attached to the Fiber Unit to reduce installation work.

What Is "Flexible" Fiber?

The flexible fiber has a small bending radius for easy routing without easily breaking. It is easy to use because the cable can be bent without significantly reducing light intensity.

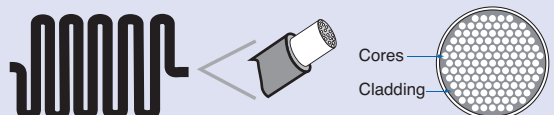

And

Breaking Due to Snagging or Shock

The Fiber Unit can be protected from breaking with stainless steel spiral tube.

→ 40 Page

Fiber Sensor
Features

Selection
Guide

Fiber Units

Threaded
Cylindrical

Standard Installation

Flat
Sleeved

Saving Space

Small Spot
High Power

Beam Improvements

Narrow view
BGS

Transparent Objects

Retro-reflective
Limited-reflective

Environmental Immunity

Chemical-resistant,
Oil-resistant
Bending

Area Detection

Heat-resistant

Liquid-level
Vacuum

Applications

FPD,
Semi,
Solar

Installation
Information

Fiber Amplifiers,
Communications
Unit, and
Accessories

Technical
Guide and
Precautions

Model Index

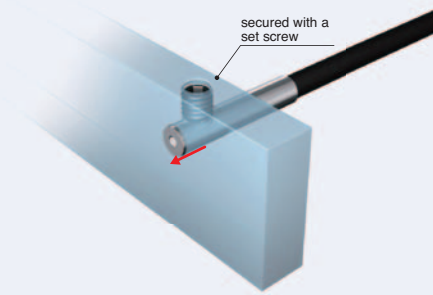

- Inserted where space is limited. (Secured using a set screw.)
- Ultramate space-saving by micro-fiber head. (1 dia. x 10 mm)



Specifications

Through-beam Fiber Units

Size	Sensing direction	Appearance (mm)	Bending radius of cable	Sensing distance (mm)			Optical axis diameter (minimum sensing object)	Models	11 Page Dimensions No.
				Simple Fiber Amplifier Units (Simple Models) E3X-SD	Smart Fiber Amplifier Units (Advanced Models) E3X-HD				
					GIGA	HS			
1 dia.	Top-View		Flexible, R1	120	450	ST : 250	0.5 dia. (5 μm dia.)	E32-T223R 2M	11-A
					150	SHS: 60			
1.5 dia.	Top-View		Bend-resistant, R4	200	680	ST : 400	0.5 dia. (5 μm dia.)	E32-T22B 2M	11-B
					220	SHS: 90			
3 dia.	Side-View		Flexible, R1	560	2,000	ST : 1,000	1 dia. (5 μm dia.)	E32-T12R 2M	11-C
					700	SHS: 280			
3 dia.	Side-View		Flexible, R1	220	750	ST : 450	1 dia. (5 μm dia.)	E32-T14LR 2M	11-D
					260	SHS: 100			

Note 1. The mode of E3X-HD that is given under the sensing distances has the following mode names and response times. GIGA: GIGA Power Mode (16 ms), HS: High-speed Mode (250 μs), ST: Standard Mode (1 ms), and SHS: Super-high-speed Mode (NPN output and E3X-HD0: 50 μs, PNP output: 55 μs)
 2. The values for the minimum sensing object are representative values that indicate values obtained in Standard Mode with the sensing distance and sensitivity set to the optimum values.

Dimensions

Installation Information → 58 Page

Through-beam Fiber Units (Set of 2)

11-A E32-T223R 2M (Free Cutting)

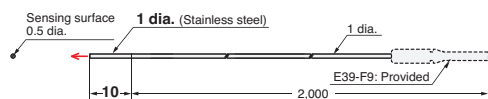

11-B E32-T22B 2M (Free Cutting)

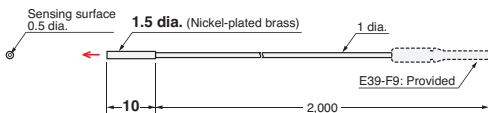

11-C E32-T12R 2M (Free Cutting)

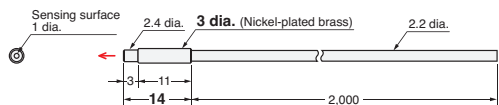

11-D E32-T14LR 2M (Free Cutting)

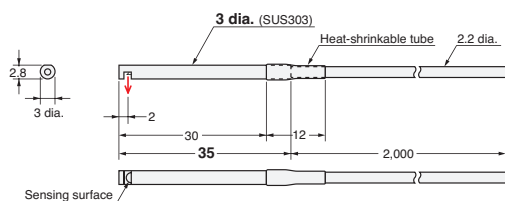

- Reference Information for Model Selection -

Recommended Mounting Hole Dimensions

The recommended mounting-hole dimensions for Cylindrical Fiber Units are given below.

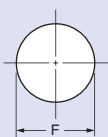

(Unit: mm)

Outer diameter of Fiber Unit	1 dia.	1.5 dia.	3 dia.
Dimension F	$1.2^{+0.5}_0$ dia.	$1.7^{+0.5}_0$ dia.	$3.2^{+0.5}_0$ dia.

Fiber Sensor
Features

Selection
Guide

Fiber Units

Threaded
Cylindrical
Standard Installation

Flat
Sleeved
Saving Space

Small Spot
High Power
Beam Improvements

Narrow
view
BGS
Transparent Objects

Retro-
reflective
Limited-
reflective
Environmental Immunity

Chemical-
resistant,
Oil-resistant
Bending
Heat-
resistant

Area
Detection
Liquid-level
Applications

Vacuum
FPD,
Semi,
Solar

Installation
Information

Fiber Amplifiers,
Communications
Unit, and
Accessories

Technical
Guide and
Precautions

Model Index

- Inserted where space is limited. (Secured using a set screw.)

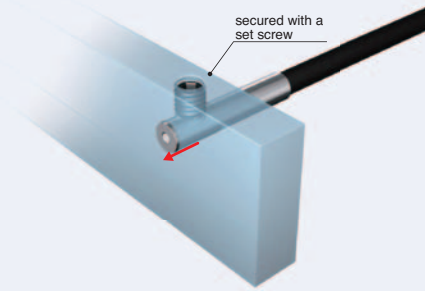

Specifications

Reflective Fiber Units

Size	Sensing direction	Appearance (mm)	Bending radius of cable	Sensing distance (mm)			Optical axis diameter (minimum sensing object)	Models	13 Page Dimensions No.
				Simple Fiber Amplifier Units (Simple Models) E3X-SD	Smart Fiber Amplifier Units (Advanced Models) E3X-HD				
					GIGA	HS			
1.5 dia.	Top-View		Bend-resistant, R4	30	140	40	ST : 60 SHS: 16	E32-D22B 2M	13-A
			R4	6	28	8	ST : 12 SHS: 4	E32-D43M 1M <i>NEW</i>	13-B
3 dia.	Top-View		Flexible, R1	30	140	40	ST : 60 SHS: 16	E32-D22R 2M	13-C
			Bend-resistant, R4	70	300	90	ST : 140 SHS: 40	E32-D221B 2M	13-D
			R25	160	700	200	ST : 300 SHS: 90	E32-D32L 2M	13-E
3 dia. + 0.8 dia.	Top-View		R4	16	70	20	ST : 30 SHS: 8	E32-D33 2M	13-F

Note 1. The mode of E3X-HD that is given under the sensing distances has the following mode names and response times.
 GIGA: GIGA Power Mode (16 ms), HS: High-speed Mode (250 μs), ST: Standard Mode (1 ms), and SHS: Super-high-speed Mode (NPN output and E3X-HD0: 50 μs, PNP output: 55 μs)
2. The values for the minimum sensing object are representative values that indicate values obtained in Standard Mode with the sensing distance and sensitivity set to the optimum values.
3. The sensing distances for Reflective Fiber Units are for white paper.

Dimensions

Installation Information → 57 Page

Reflective Fiber Units

13-A E32-D22B 2M (No Cutting)

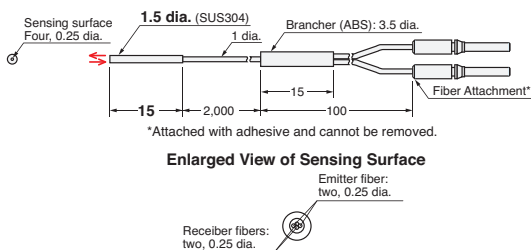

13-B E32-D43M 1M (No Cutting)

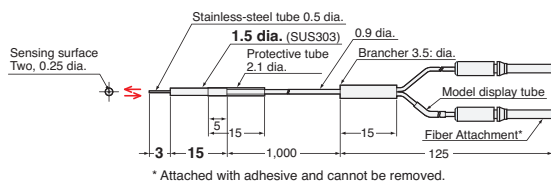

13-C E32-D22R 2M (Free Cutting)



13-D E32-D221B 2M (Free Cutting)

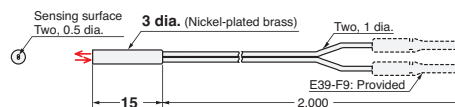

13-E E32-D32L 2M (Free Cutting)

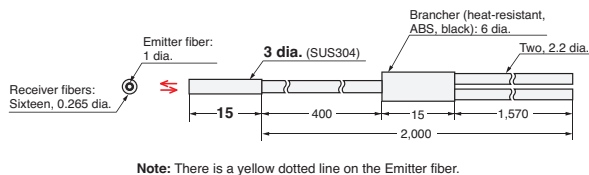

13-F E32-D33 2M (Free Cutting)

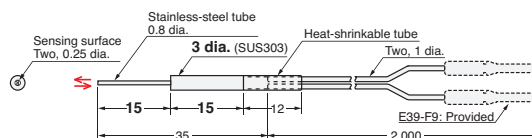

- Reference Information for Model Selection -

Features of Coaxial Reflective Type

These Fiber Units offer better detection of small objects at close distances (of 2 mm or less) than Standard Reflective Fiber Units. They also detect glossy surfaces more reliably than Standard Reflective Fiber Units, even if the surface is tilted. The receiver fibers are arranged around the emitter fiber as shown below.



Recommended Mounting Hole Dimensions

The recommended mounting-hole dimensions for Cylindrical Fiber Units are given below.

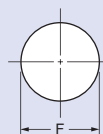

(Unit: mm)

Outer diameter of Fiber Unit	1.5 dia.	3 dia.
Dimension F	1.7 ^{+0.5} ₀	3.2 ^{+0.5} ₀

Fiber Sensor Features

Selection Guide

Fiber Units

Threaded

Cylindrical

Standard Installation

Flat

Sleeved

Saving Space

Small Spot

High Power

Beam Improvements

Narrow view

BGS

Retro-reflective

Limited-reflective

Transparent Objects

Chemical-resistant, Oil-resistant

Bending

Environmental Immunity

Heat-resistant

Area Detection

Liquid-level

Applications

Vacuum

FPD, Semi, Solar

Installation Information

Fiber Amplifiers, Communications Unit, and Accessories

Technical Guide and Precautions

Model Index

Threaded

Cylindrical

Flat

Sleeved

Small Spot

High Power

Narrow view

BGS

Retro-reflective

Limited-reflective

Chemical-resistant, Oil-resistant

Bending

Heat-resistant

Area Detection

Liquid-level

Vacuum

FPD, Semi, Solar

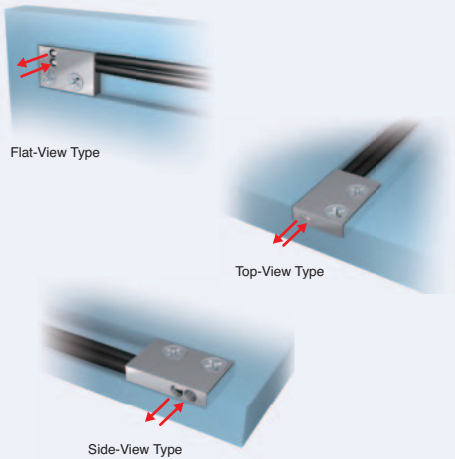

- Thin profile for mounting in limited spaces.
- Mounts directly without using special mounting brackets.

Specifications

Through-beam Fiber Units

Sensing direction	Appearance (mm)	Bending radius of cable	Sensing distance (mm)			Optical axis diameter (minimum sensing object)	Models	15 Page Dimensions No.
			Simple Fiber Amplifier Units (Simple Models) E3X-SD	Smart Fiber Amplifier Units (Advanced Models) E3X-HD				
				GIGA	HS			
Top-View		Flexible, R1	560	2,000	ST : 1,000	1 dia. (5 μm dia.)	E32-T15XR 2M	15-A
Side-View			220	750	SHS: 280			
Flat-View			220	260	SHS: 100			

Reflective Fiber Units

Sensing direction	Appearance (mm)	Bending radius of cable	Sensing distance (mm)			Optical axis diameter (minimum sensing object)	Models	15 Page Dimensions No.
			Simple Fiber Amplifier Units (Simple Models) E3X-SD	Smart Fiber Amplifier Units (Advanced Models) E3X-HD				
				GIGA	HS			
Top-View		Flexible, R1	180	840	ST : 350	(5 μm dia.)	E32-D15XR 2M	15-D
Side-View			40	200	SHS: 100			
Flat-View			40	52	SHS: 24			

Note 1. The mode of E3X-HD that is given under the sensing distances has the following mode names and response times.
 GIGA: GIGA Power Mode (16 ms), HS: High-speed Mode (250 μs), ST: Standard Mode (1 ms), and SHS: Super-high-speed Mode (NPN output and E3X-HD0: 50 μs, PNP output: 55 μs)
Note 2. The values for the minimum sensing object are representative values that indicate values obtained in Standard Mode with the sensing distance and sensitivity set to the optimum values.
Note 3. The sensing distances for Reflective Fiber Units are for white paper.

Dimensions

Installation Information → 58 Page

Installation Information → 56 Page

Through-beam Fiber Units (Set of 2)

15-A E32-T15XR 2M (Free Cutting)

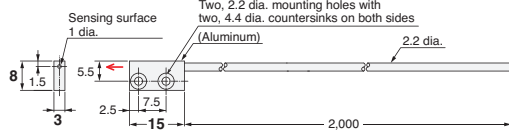

Note: 1. Set of two symmetrically shaped Fiber Units.
2. Four, M2 x 8 stainless steel countersunk mounting screws are provided.

15-B E32-T15YR 2M (Free Cutting)

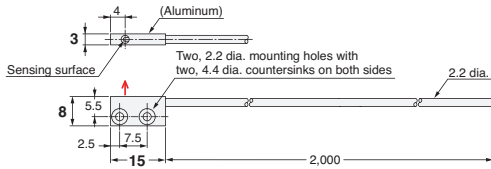

Note: 1. Set of two symmetrically shaped Fiber Units.
2. Four, M2 x 8 stainless steel countersunk mounting screws are provided.

15-C E32-T15ZR 2M (Free Cutting)

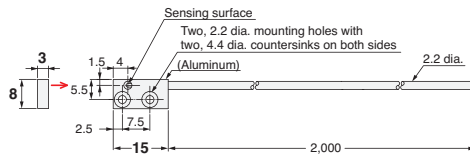

Note: 1. Set of two symmetrically shaped Fiber Units.
2. Four, M2 x 8 stainless steel countersunk mounting screws are provided.

Reflective Fiber Units

15-D E32-D15XR 2M (Free Cutting)

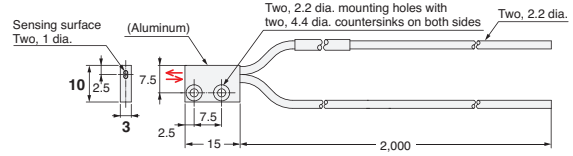

Note: Two, M2 x 8 stainless steel countersunk mounting screws are provided.

15-E E32-D15YR 2M (Free Cutting)

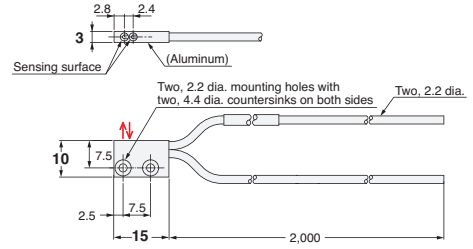

Note: Two, M2 x 8 stainless steel countersunk mounting screws are provided.

15-F E32-D15ZR 2M (Free Cutting)

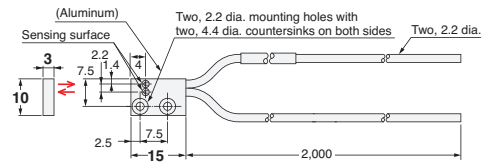

Note: Two, M2 x 8 stainless steel countersunk mounting screws are provided.

Fiber Sensor Features

Selection Guide

Fiber Units

Threaded

Cylindrical

Flat

Sleeved

Small Spot

High Power

Narrow view

BGS

Retro-reflective

Limited-reflective

Chemical-resistant, Oil-resistant

Bending

Heat-resistant

Area Detection

Liquid-level

Vacuum

FPD, Semi, Solar

Standard Installation

Saving Space

Beam Improvements

Transparent Objects

Environmental Immunity

Applications

Installation Information

Fiber Amplifiers, Communications Unit, and Accessories

Technical Guide and Precautions

Model Index

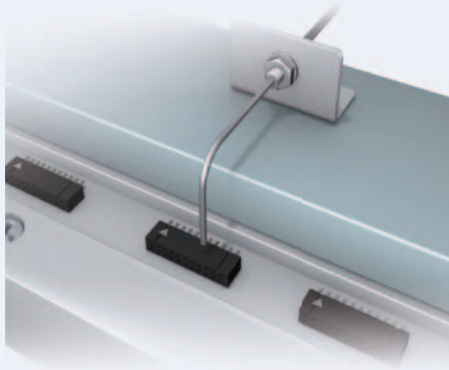

- Sleeve Fiber Units allow detection away from the point of installation for stable close-range detection of small objects.
- The shape of sleeve can be changed freely.

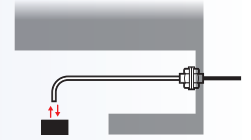

Specifications

Through-beam Fiber Units

Sensing direction	Appearance (mm)	Bending radius of cable	Sensing distance (mm)			Optical axis diameter (minimum sensing object)	Models	17 Page Dimensions No.
			Simple Fiber Amplifier Units (Simple Models) E3X-SD	Smart Fiber Amplifier Units (Advanced Models) E3X-HD				
				GIGA	HS			
Side-View		Flexible, R1	60	170	ST : 100 SHS: 20	0.5 dia. (5 μm dia.)	E32-T24R 2M	17-A
		R10	180	450	ST : 250 SHS: 60		E32-T24E 2M NEW	17-B
Top-View		R10	40	150	ST : 90 SHS: 20	0.25 dia. (5 μm dia.)	E32-T33 1M	17-C
		Flexible, R1	560	2,000	ST : 1,000 SHS: 280	1 dia. (5 μm dia.)	E32-TC200BR 2M	17-D

Reflective Fiber Units

Sensing direction	Appearance (mm)	Bending radius of cable	Sensing distance (mm)			Optical axis diameter (minimum sensing object)	Models	17 Page Dimensions No.
			Simple Fiber Amplifier Units (Simple Models) E3X-SD	Smart Fiber Amplifier Units (Advanced Models) E3X-HD				
				GIGA	HS			
Side-View		Flexible, R1	14	70	ST : 30 SHS: 8	5 μm dia.)	E32-D24R 2M	17-E
Top-View		6	28	ST : 12 SHS: 4	E32-D43M 1M NEW		17-F	
		R4	3	14	ST : 6 SHS: 2		E32-D331 2M	17-G
		16	70	ST : 30 SHS: 8	E32-D33 2M		17-H	
		30	140	ST : 60 SHS: 16	E32-DC200F4R 2M		17-I	
		180	840	ST : 350 SHS: 100	E32-DC200BR 2M		17-J	

Note 1. The mode of E3X-HD that is given under the sensing distances has the following mode names and response times.
GIGA: GIGA Power Mode (16 ms), HS: High-speed Mode (250 μs), ST: Standard Mode (1 ms), and SHS: Super-high-speed Mode (NPN output and E3X-HD0: 50 μs, PNP output: 55 μs)
2. The values for the minimum sensing object are representative values that indicate values obtained in Standard Mode with the sensing distance and sensitivity set to the optimum values.
3. The sensing distances for Reflective Fiber Units are for white paper.

Dimensions

Installation Information → 58 and 59 Page

Installation Information → 57 Page

Through-beam Fiber Units (Set of 2)

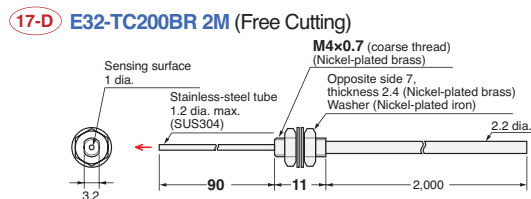
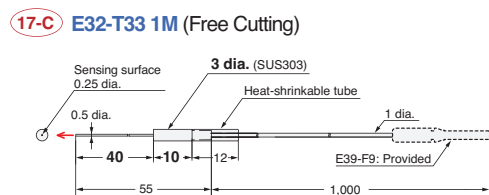
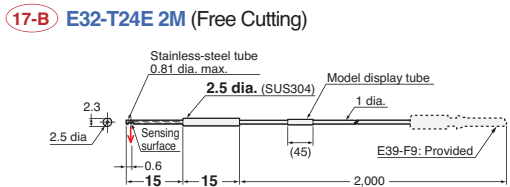
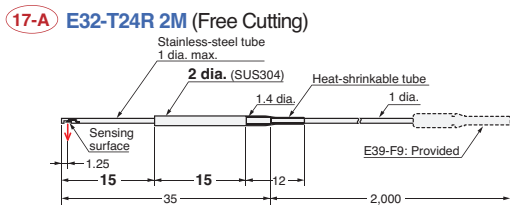

Reflective Fiber Units

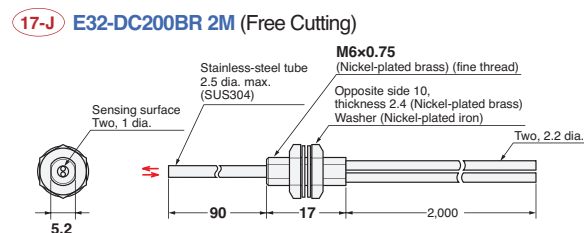
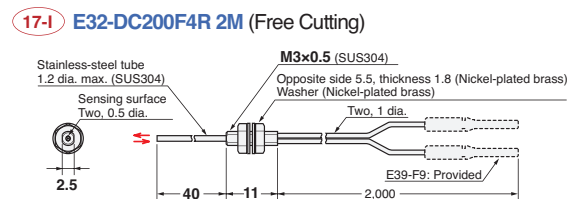
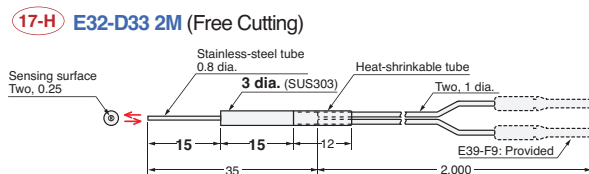
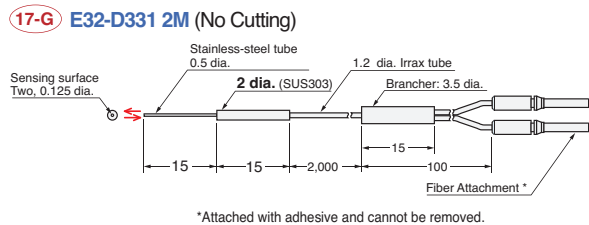
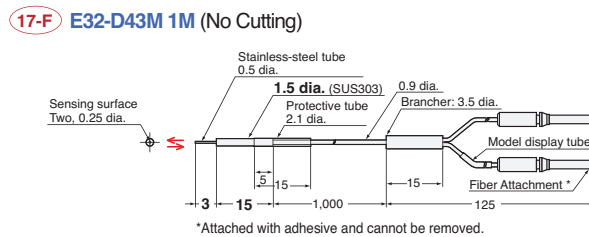
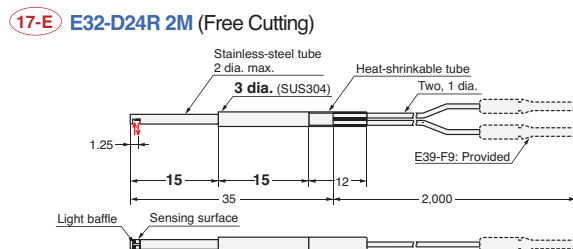

- Reference Information for Model Selection -

And

In case of bending sleeve

The E32-TC200BR and E32-DC200F4R have bendable sleeves. Use the Sleeve Bender to bend them.

Sleeve Bender (sold separately)

Appearance	Applicable Fiber Units	Model
 Uses for the bending of the sleeve.	E32-TC200BR E32-DC200F4R	E39-F11

Fiber Sensor Features

Selection Guide

Fiber Units

Threaded

Cylindrical

Flat

Sleeved

Small Spot

High Power

Narrow view

BGS

Retro-reflective

Limited-reflective

Chemical-resistant, Oil-resistant

Bending

Heat-resistant

Area Detection

Liquid-level

Vacuum

FPD, Semi, Solar

Installation Information

Fiber Amplifiers, Communications Unit, and Accessories

Technical Guide and Precautions

Model Index

Threaded

Cylindrical

Flat

Sleeved

Small Spot

High Power

Narrow view

BGS

Retro-reflective

Limited-reflective

Chemical-resistant, Oil-resistant

Bending

Heat-resistant

Area Detection

Liquid-level

Vacuum

FPD, Semi, Solar

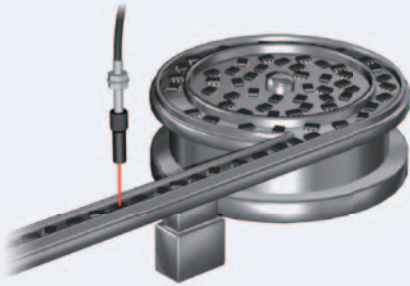

- Small-spot is ideal for detecting minute objects. Select the Fiber Unit that is best suited for the workpiece size and installation distance. (Refer to Reference Information for Model Selection)
- Available with a variable-spot Lens Unit to change the spot diameter without replacing the fiber. The spot diameter can be adjusted according to the size of the workpiece by changing the withdrew length and sensing distance. Refer to the following graph, which shows the relation between the withdrew length, focal distance, and spot diameter.

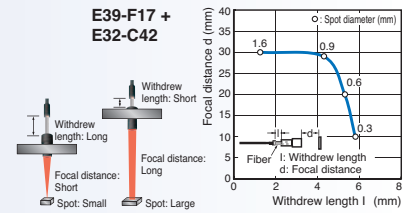
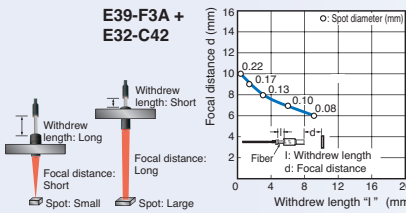

* Withdrew length: Approx. 1.3 to 5.8 mm

Specifications

Reflective Fiber Units

Variable-spot types

Lens Units + Fiber Unit

Type	Spot diameter	Center distance (mm)	Lens Units	Lens Units + Fiber Units	Fiber Unit		19 Page Dimensions No.
			Models	Appearance	Bending radius of cable	Model	
Variable spot	0.1 to 0.6 dia.	6 to 15	E39-F3A		R25	E32-C42 1M	19-A
	0.3 to 1.6 dia.	10 to 30	E39-F17				19-B

Parallel-light-spot types

Lens Unit + Fiber Units

Type	Spot diameter	Center distance (mm)	Lens Unit	Lens Units + Fiber Units	Fiber Units		19 Page Dimensions No.
			Model	Appearance	Bending radius of cable	Models	
Parallel light	4 dia.	0 to 20	E39-F3C		R25	E32-C31 2M	19-C
							Pliable, R4

Small-spot types

Integrated Lens

Type	Spot diameter	Center distance (mm)	Appearance	Bending radius of cable	Models	19 Page Dimensions No.
Short-distance, Small-spot	0.1 dia.	5	 Lens: unnecessary	R25	E32-C42S 1M	19-E
Long-distance, Small-spot	6 dia.	50	 Lens: unnecessary		E32-L15 2M	19-F

* The spot diameter and the center distance are same when using with E3X-HD series or E3X-SD series.

Dimensions

Installation Information → 56, 57 and 58 Page

Reflective Fiber Units

19-A E32-C42 1M (No Cutting) + E39-F3A

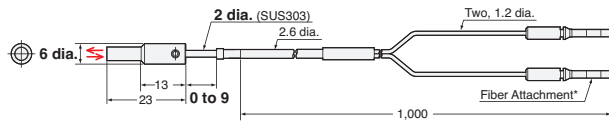

* Attached with adhesive and cannot be removed.
Note: There is a white tube on the emitter fiber.

E39-F3A

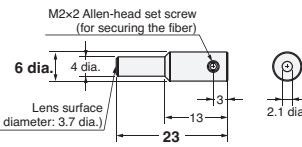

Material: Aluminum for body and optical glass for lens.
Note: This is the Lens Unit for the E32-C42.

19-B E32-C42 1M (No Cutting) + E39-F17

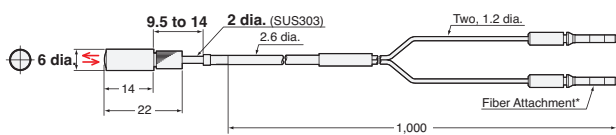

* Attached with adhesive and cannot be removed.
Note: There is a white tube on the emitter fiber.

E39-F17

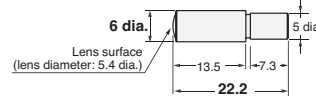

Material: Aluminum for body and optical glass for lens.

19-C E32-C31 2M (Free Cutting) + E39-F3C

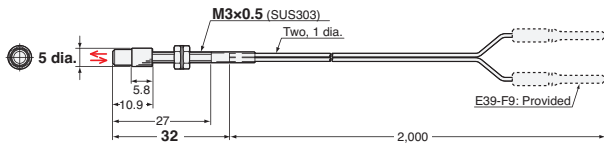

Note: There is a white line on the emitter fiber.

E39-F3C

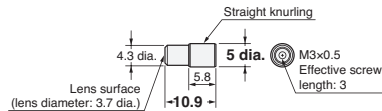

Material: Aluminum for body and optical glass for lens.
Note: This is the Lens Unit for the E32-C31 and E32-C31N.

19-D E32-C31N 2M (Free Cutting) + E39-F3C

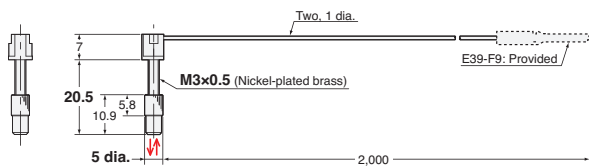

Note: There is a white line on the emitter fiber.

19-E E32-C42S 1M (No Cutting)

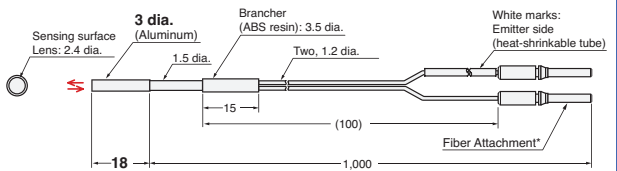

* Attached with adhesive and cannot be removed.
Note: There is a white tube on the emitter fiber.

19-F E32-L15 2M (Free Cutting)

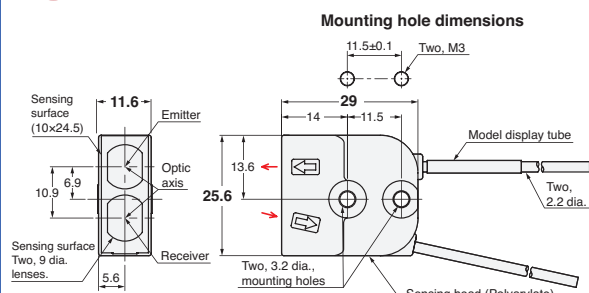

Note: There is a white tube on the emitter fiber.

- Reference Information for Model Selection -

Model Selection Tips

- Select the best model by following these steps.
1. Select the model based on the spot diameter suitable for the workpiece size.
* The Variable-spot Type is useful if there are different sensing object sizes.
 2. Select the model based on the allowable installation distance and center distance.

<Map of Spot Diameters and Center Distances>

(Unit: mm)

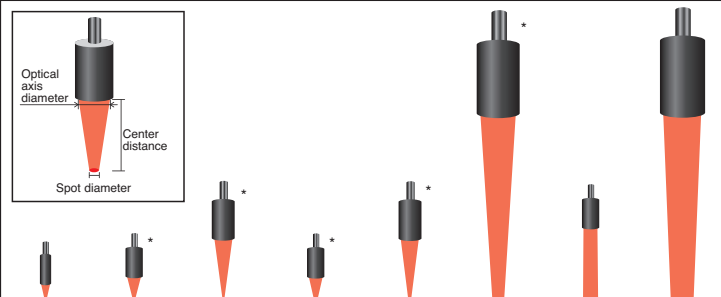

Spot diameter	0.1 dia.	0.1 dia.	0.2 dia.	0.5 dia.	0.5 dia.	3 dia.	4 dia.	6 dia.
Center distance	5	7	17	7	17	50	0 to 20	50
Optical axis diameter	2.4	3.7	4.8	3.7	4.8	9.4	3.7	10
Models	E32-C42S	E39-F3A-5 + E32-C41	E39-F3B + E32-C41	E39-F3A-5 + E32-C31 (N)	E39-F3B + E32-C31 (N)	E39-F18 + E32-CC200 E32-C11N	E39-F3C + E32-C31 (N)	E32-L15

* Refer to page 20 for details.

Fiber Sensor Features

Selection Guide

Fiber Units

Threaded

Standard Installation

Cylindrical

Flat

Saving Space

Sleeved

Small Spot

Beam Improvements

High Power

Narrow view

BGS

Retro-reflective

Transparent Objects

Limited-reflective

Chemical-resistant, Oil-resistant

Environmental Immunity

Bending

Heat-resistant

Area Detection

Liquid-level

Applications

Vacuum

FPD, Semi, Solar

Installation Information

Fiber Amplifiers, Communications Unit, and Accessories

Technical Guide and Precautions

Model Index

Threaded

Cylindrical

Flat

Sleeved

Small Spot

High Power

Narrow view

BGS

Retro-reflective

Limited-reflective

Chemical-resistant, Oil-resistant

Bending

Heat-resistant

Area Detection

Liquid-level

Vacuum

FPD, Semi, Solar

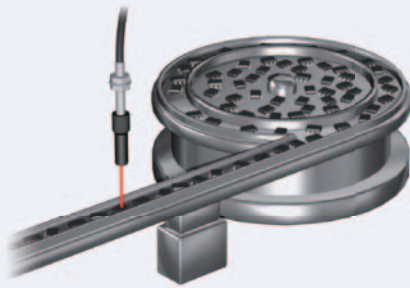

- Small-spot is ideal for detecting minute objects. Select the Fiber Unit that is best suited for the workpiece size and installation distance. (Refer to Reference Information for Model Selection)

Specifications

Reflective Fiber Units

Small-spot Models

Lens Units + Fiber Units

Type	Spot diameter	Center distance (mm)	Lens Units	Lens Units + Fiber Units	Fiber Units		21 Page Dimensions No.
			Models	Appearance	Bending radius of cable	Models	
Short-distance, small-spot	0.1 dia.	7	E39-F3A-5		R25	E32-C41 1M	21-A
	0.5 dia.						
				0.2 dia.	17	E39-F3B	
0.5 dia.		R25	E32-C41 1M				21-D
	0.5 dia.	50	E39-F18				
3 dia.					R25	E32-CC200 2M	21-G
				3 dia.	50	E39-F18	

* The spot diameter and the center distance are same when using with E3X-HD series or E3X-SD series.

Dimensions

Installation Information → 56 and 59 Page

Reflective Fiber Units

21-A E32-C41 1M (No Cutting) + E39-F3A-5

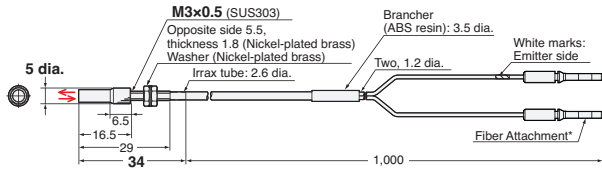

* Attached with adhesive and cannot be removed.
Note: There is a white tube on the emitter fiber.

21-B E32-C31 2M (Free Cutting) + E39-F3A-5

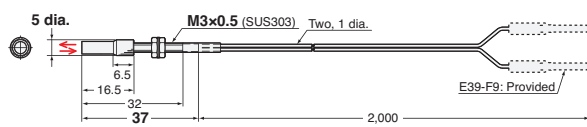

Note: There is a white line on the emitter fiber.

E39-F3A-5

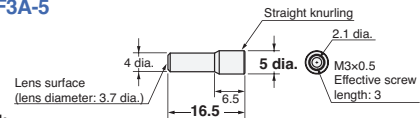

Material:
Aluminum for body and optical glass for lens

Note: This is a Lens Unit for the E32-C41, E32-C31 and E32-C31N.

21-C E32-C31N 2M (Free Cutting) + E39-F3A-5

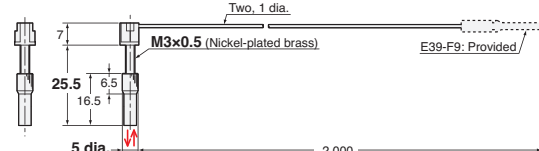

Note: There is a white line on the emitter fiber.

21-D E32-C41 1M (No Cutting) + E39-F3B

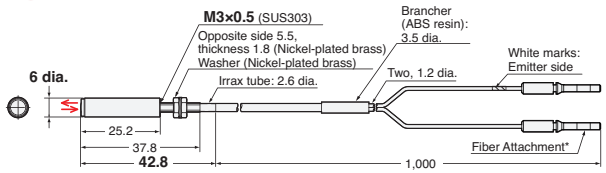

* Attached with adhesive and cannot be removed.
Note: There is a white tube on the emitter fiber.

21-E E32-C31 2M (Free Cutting) + E39-F3B

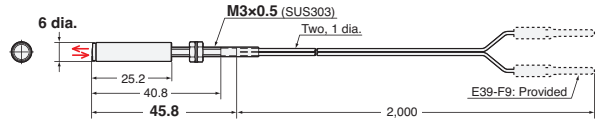

Note: There is a white line on the emitter fiber.

E39-F3B

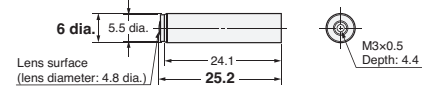

Material:
Aluminum for body and optical glass for lens

Note: This is a Lens Unit for the E32-C41, E32-C31 and E32-C31N.

21-F E32-C31N 2M (Free Cutting) + E39-F3B

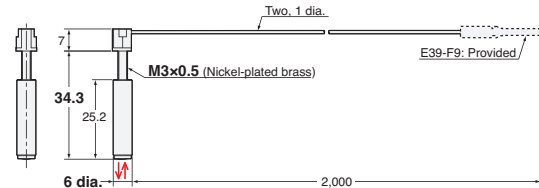

Note: There is a white line on the emitter fiber.

21-G E32-CC200 2M (Free Cutting) + E39-F18

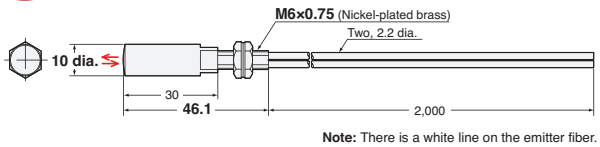

Note: There is a white line on the emitter fiber.

21-H E32-C11N 2M (Free Cutting) + E39-F18

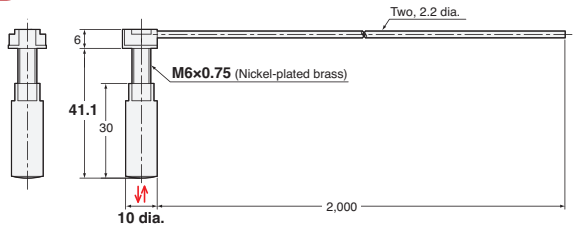

Note: There is a white line on the emitter fiber.

E39-F18

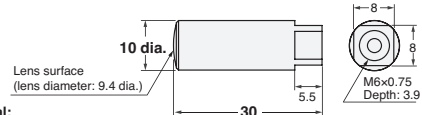

Material:
Aluminum for body and optical glass for lens

Note: This is a Lens Unit for the E32-C11N and E32-CC200.

- Reference Information for Model Selection -

Model Selection Tips

Select the best model by following these steps.

1. Select the model based on the spot diameter suitable for the workpiece size.

* The Variable-spot Type is useful if there are different sensing object sizes.

2. Select the model based on the allowable installation distance and center distance.

<Map of Spot Diameters and Center Distances>

(Unit: mm)

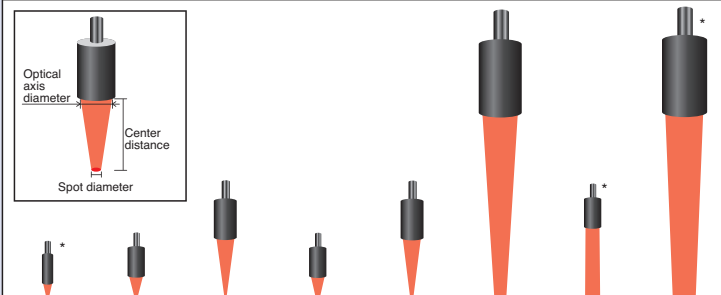

Spot diameter	0.1 dia.	0.1 dia.	0.2 dia.	0.5 dia.	0.5 dia.	3 dia.	4 dia.	6 dia.
Center distance	5	7	17	7	17	50	0 to 20	50
Optical axis diameter	2.4	3.7	4.8	3.7	4.8	9.4	3.7	10
Models	E32-C42S	E39-F3A-5 + E32-C41	E39-F3B + E32-C41	E39-F3A-5 + E32-C31 (N)	E39-F3B + E32-C31 (N)	E39-F18 + E32-CC200	E39-F3C + E32-C31 (N)	E32-L15

* Refer to page 18 for details.

Fiber Sensor Features

Selection Guide

Fiber Units

Threaded

Cylindrical

Flat

Sleeved

Small Spot

High Power

Narrow view

BGS

Retro-reflective

Limited-reflective

Chemical-resistant, Oil-resistant

Bending

Heat-resistant

Area Detection

Liquid-level

Vacuum

FPD, Semi, Solar

Installation Information

Fiber Amplifiers, Communications Unit, and Accessories

Technical Guide and Precautions

Model Index

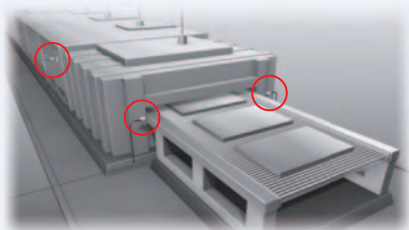

- Maximum sensing distance without attaching a Lens: 20 m (E32-T17L)
Suitable for detection of large objects and for use in large-scale installations.
- Powerful enough to resist the influences of dust and dirt.
- In addition to the products listed on this page, Lenses are available to extend the sensing distance. (→ 24 to 27 pages)

Standard Installation
Threaded
Cylindrical

Saving Space
Flat
Sleeved

Specifications

Through-beam Fiber Units

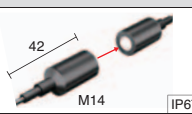
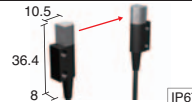
Sensing direction	Aperture angle	Appearance (mm)	Bending radius of cable	Sensing distance (mm)			Optical axis diameter (minimum sensing object)	Models	23 Page Dimensions No.
				Simple Fiber Amplifier Units (Simple Models) E3X-SD	Smart Fiber Amplifier Units (Advanced Models) E3X-HD				
					GIGA	HS			
Top-View	10°		R25	20,000 *1	20,000 *1	ST : 20,000 *1 SHS: 8,000	10 dia.	E32-T17L 10M	23-A
Side-View	30°		R25	3,600	4,000 *2	ST : 4,000 *2 SHS: 1,800	4 dia. (0.1 dia.)	E32-T14 2M	23-B

*1 The optical fiber is 10 m long on each side, so the sensing distance is 20,000 mm.
*2 The optical fiber is 2 m long on each side, so the sensing distance is 4,000 mm.

Small Spot
High Power
Narrow view
BGS

Transparent Objects
Retro-reflective
Limited-reflective

Environmental Immunity
Chemical-resistant, Oil-resistant
Bending
Heat-resistant

Applications
Area Detection
Liquid-level
Vacuum
FPD, Semi, Solar

Installation Information

Fiber Amplifiers, Communications Unit, and Accessories

Technical Guide and Precautions

Model Index

Reflective Fiber Units

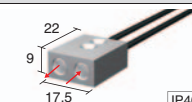
Sensing direction	Aperture angle	Appearance (mm)	Bending radius of cable	Sensing distance (mm)			Optical axis diameter (minimum sensing object)	Model	23 Page Dimensions No.
				Simple Fiber Amplifier Units (Simple Models) E3X-SD	Smart Fiber Amplifier Units (Advanced Models) E3X-HD				
					GIGA	HS			
Top-View	4°		Bend-resistant, R4	800	40 to 2,800	ST : 40 to 1,400 SHS: 40 to 480	-	E32-D16 2M	23-C

Note 1. The mode of E3X-HD that is given under the sensing distances has the following mode names and response times.
GIGA: GIGA Power Mode (16 ms), HS: High-speed Mode (250 μs), ST: Standard Mode (1 ms), and SHS: Super-high-speed Mode (NPN output and E3X-HD0: 50 μs, PNP output: 55 μs)
2. The values for the minimum sensing object are representative values that indicate values obtained in Standard Mode with the sensing distance and sensitivity set to the optimum values.
3. The sensing distances for Reflective Fiber Units are for white paper.

Dimensions

Installation Information → 58 Page

Through-beam Fiber Units (Set of 2)

23-A E32-T17L 10M (Free Cutting)

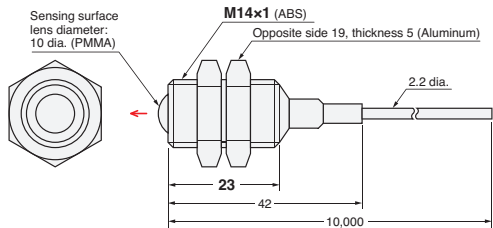

23-B E32-T14 2M (Free Cutting)

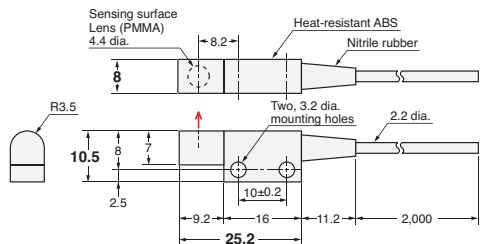

Installation Information → 56 Page

Reflective Fiber Units

23-C E32-D16 2M (Free Cutting)

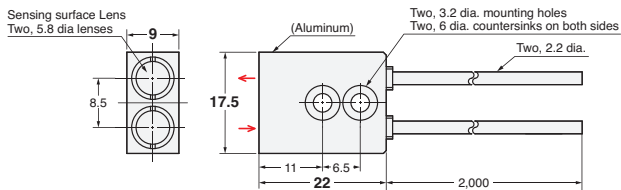

- Reference Information for Model Selection -

Comparisons of incident level

Select the model based on the comparisons of incident level against Standard Fiber Units.

Comparisons of incident level (Through-beam)

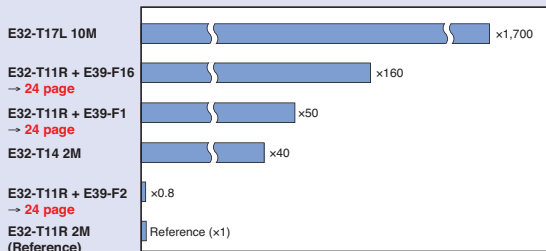

Comparisons of incident level (Reflective)

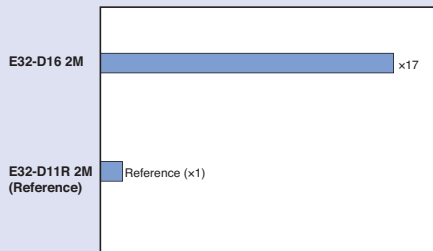

Fiber Sensor Features

Selection Guide

Fiber Units

Threaded

Standard Installation

Cylindrical

Flat

Saving Space

Sleeved

Small Spot

High Power

Beam Improvements

Narrow view

BGS

Retro-reflective

Transparent Objects

Limited-reflective

Chemical-resistant, Oil-resistant

Environmental Immunity

Bending

Heat-resistant

Area Detection

Liquid-level

Applications

Vacuum

FPD, Semi, Solar

Installation Information



Fiber Amplifiers, Communications Unit, and Accessories

Technical Guide and Precautions

Model Index

Specifications

Through-beam Fiber Units

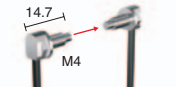
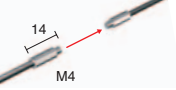
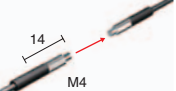
Lens Units	Type	High-power (incident level: 50 times)	Ultra-high-power (incident level: 160 times)	Side-View (incident level: 0.8 times)				
	Models	E39-F1	E39-F16	E39-F2				
	Appearance	 (24-A)	 (24-B)	 (24-C)				
	Aperture angle	Approx. 12°	Approx. 6°	Approx. 60°				
Fiber Units	Optical axis diameter (minimum sensing object)	4 dia. (0.1 dia.)	7.2 dia.	3 dia. (0.1 dia.)				
Models	Appearance (mm)	Sensing distance (mm)						
		Simple Fiber Amplifier Units E3X-SD	Smart Fiber Amplifier Units E3X-HD		Simple Fiber Amplifier Units E3X-SD	Smart Fiber Amplifier Units E3X-HD		
		■ GIGA ■ HS	■ GIGA ■ HS	■ GIGA ■ HS	■ GIGA ■ HS	■ GIGA ■ HS	■ GIGA ■ HS	
		Other modes	Other modes		Other modes	Other modes		
E32-T11N 2M		3,700	4,000 * 4,000 *	ST : 4,000 * SHS: 2,000 (25-A)	4,000 * 4,000 *	4,000 * 4,000 *	ST : 4,000 * SHS: 3,600 (25-D)	— —
E32-T11R 2M		4,000 *	4,000 * 4,000 *	ST : 4,000 * SHS: 2,000 (25-B)	4,000 * 4,000 *	4,000 * 4,000 *	ST : 4,000 * SHS: 3,600 (25-E)	1,450 500 (25-G)
E32-T11 2M		4,000 *	4,000 * 4,000 *	ST : 4,000 * SHS: 1,860 (25-C)	4,000 * 4,000 *	4,000 * 4,000 *	ST : 4,000 * SHS: 4,000 * (25-F)	2,300 860 (25-H)

* The optical fiber is 2 m long on each side, so the sensing distance is 4,000 mm.

Note 1. The mode of E3X-HD that is given under the sensing distances has the following mode names and response times.

GIGA: GIGA Power Mode (16 ms), HS: High-speed Mode (250 μs), ST: Standard Mode (1 ms), and SHS: Super-high-speed Mode (NPN output and E3X-HD0: 50 μs, PNP output: 55 μs)

2. The values for the minimum sensing object are representative values that indicate values obtained in Standard Mode with the sensing distance and sensitivity set to the optimum values.

Dimensions

Installation Information → 59 Page

Lens Units (Set of 2)

(24-A) E39-F1

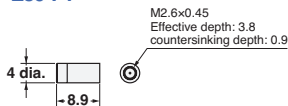

Material: Brass for the body and optical glass for the lens itself.

Note: Two per set.

(24-B) E39-F16

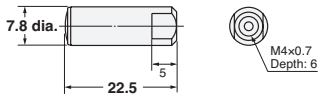

Material: SUS303 for the body and optical glass for the lens itself.

Note: Two per set.

(24-C) E39-F2

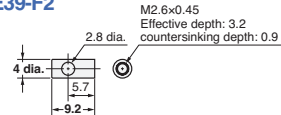

Material: Brass for the body and optical glass for the lens itself.

Note: Two per set.

Threaded

Cylindrical

Flat

Sleeved

Small Spot

High Power

Narrow view

BGS

Retro-reflective

Limited-reflective

Chemical-resistant, Oil-resistant

Bending

Heat-resistant

Area Detection

Liquid-level

Vacuum

FPD, Semi, Solar

Dimensions

Installation Information → 58 and 59 Page

Through-beam Fiber Units (Set of 2)

25-A E32-T11N 2M (Free Cutting) + E39-F1

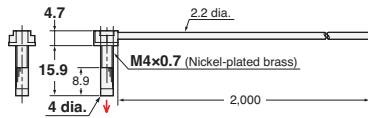

25-B E32-T11R 2M (Free Cutting) + E39-F1

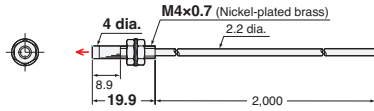

25-C E32-T11 2M (Free Cutting) + E39-F1

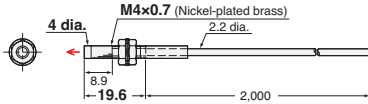

25-D E32-T11N 2M (Free Cutting) + E39-F16

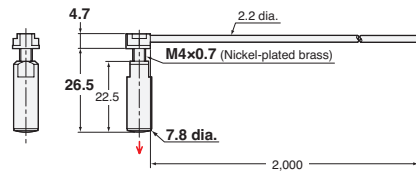

25-E E32-T11R 2M (Free Cutting) + E39-F16

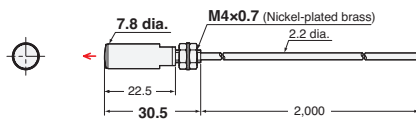

25-F E32-T11 2M (Free Cutting) + E39-F16

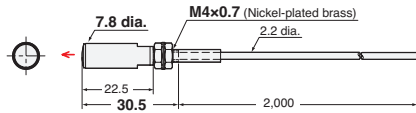

25-G E32-T11R 2M (Free Cutting) + E39-F2

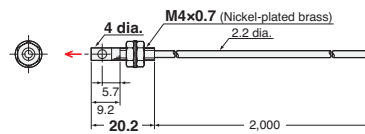

25-H E32-T11 2M (Free Cutting) + E39-F2

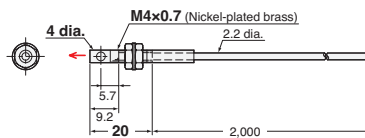

Fiber Sensor Features

Selection Guide

Fiber Units

Threaded

Cylindrical

Flat

Sleeved

Small Spot

High Power

Narrow view

BGS

Retro-reflective

Limited-reflective

Chemical-resistant, Oil-resistant

Bending

Heat-resistant

Area Detection

Liquid-level

Vacuum

FPD, Semi, Solar

Standard Installation

Saving Space

Beam Improvements

Transparent Objects

Environmental Immunity

Applications

Installation Information

Fiber Amplifiers, Communications Unit, and Accessories

Technical Guide and Precautions

Model Index

- Reference Information for Model Selection -

Comparisons of incident level

Select the model based on the comparisons of incident level against Standard Fiber Units.

Comparisons of incident level (Through-beam)

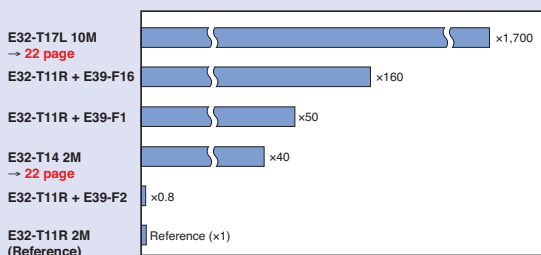

Threaded

Cylindrical

Flat

Sleeved

Small Spot

High Power

Narrow view

BGS

Retro-reflective

Limited-reflective

Chemical-resistant, Oil-resistant

Bending

Heat-resistant

Area Detection



Liquid-level

Vacuum

FPD, Semi, Solar

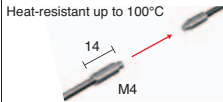
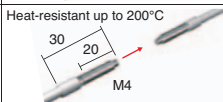
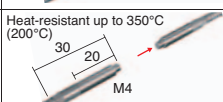

Specifications

Through-beam Fiber Units

Lens Units	Type	High-power (incident level: 50 times)	Ultra-high-power (incident level: 160 times)	Side-View (incident level: 0.8 times)						
	Models	E39-F1	E39-F16	E39-F2						
	Appearance	 (26-A)	 (26-B)	 (26-C)						
	Aperture angle	Approx. 12°	Approx. 6°	Approx. 60°						
Fiber Units	Optical axis diameter (minimum sensing object)	4 dia. (0.1 dia.)	7.2 dia. (0.1 dia.)	3 dia. (0.1 dia.)						
Models	Appearance (mm)	Sensing distance (mm)								
		Simple Fiber Amplifier Units E3X-SD		Smart Fiber Amplifier Units E3X-HD		Simple Fiber Amplifier Units E3X-SD		Smart Fiber Amplifier Units E3X-HD		
			■ GIGA ■ HS	Other modes		■ GIGA ■ HS	Other modes		■ GIGA ■ HS	Other modes
E32-T51R 2M	Heat-resistant up to 100°C 	2,000	4,000 * 3,900	ST : 4,000 * SHS: 1,500 (27-A)	4,000 *	4,000 * 4,000 *	ST : 4,000 * SHS: 4,000 * (27-D)	360	1,400 500	ST : 720 SHS: 200 (27-G)
E32-T81R-S 2M	Heat-resistant up to 200°C 	1,800	4,000 * 2,700	ST : 4,000 * SHS: 1,000 (27-B)	4,000 *	4,000 * 4,000 *	ST : 4,000 * SHS: 1,800 (27-E)	280	1,000 360	ST : 550 SHS: 140 (27-H)
E32-T61-S	Heat-resistant up to 350°C (200°C) 	4,000 *	4,000 * 4,000 *	ST : 4,000 * SHS: 1,800 (27-C)	4,000 *	4,000 * 4,000 *	ST : 4,000 * SHS: 3,100 (27-F)	780	1,680 600	ST : 900 SHS: 240 (27-I)

* The optical fiber is 2 m long on each side, so the sensing distance is 4,000 mm.

- Note 1.** The mode of E3X-HD that is given under the sensing distances has the following mode names and response times.
GIGA: GIGA Power Mode (16 ms), HS: High-speed Mode (250 μs), ST: Standard Mode (1 ms), and SHS: Super-high-speed Mode (NPN output and E3X-HD0: 50 μs, PNP output: 55 μs)
- 2.** The values for the minimum sensing object are representative values that indicate values obtained in Standard Mode with the sensing distance and sensitivity set to the optimum values.
- 3.** The ambient temperature of E32-T61-S must be between -40 to 200°C when using it with E39-F1 or E39-F2 Lens Unit.
The ambient temperature of E32-T61-S must be between -40 to 350°C when using it with E39-F16 Lens Unit.

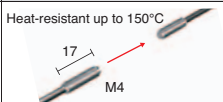
Lens Units	Type	High-power (incident level: 50 times)	Ultra-high-power (incident level: 160 times)				
	Models	E39-F1-33	E39-F16				
	Appearance	 (26-D)	 (26-B)				
	Aperture angle	Approx. 12°	Approx. 6°				
Fiber Units	Optical axis diameter (minimum sensing object)	4 dia. (0.1 dia.)	7.2 dia. (0.1 dia.)				
Model	Appearance (mm)	Appearance (mm)					
		Simple Fiber Amplifier Units E3X-SD		Smart Fiber Amplifier Units E3X-HD			
			■ GIGA ■ HS	Other modes		■ GIGA ■ HS	Other modes
E32-T51 2M	Heat-resistant up to 150°C 	2,400	4,000 * 2,300	ST : 4,000 * SHS: 1,400 (27-J)	4,000 *	4,000 * 4,000 *	ST : 4,000 * SHS: 4,000 * (27-K)

* The optical fiber is 2 m long on each side, so the sensing distance is 4,000 mm.

- Note 1.** The mode of E3X-HD that is given under the sensing distances has the following mode names and response times.
GIGA: GIGA Power Mode (16 ms), HS: High-speed Mode (250 μs), ST: Standard Mode (1 ms), and SHS: Super-high-speed Mode (NPN output and E3X-HD0: 50 μs, PNP output: 55 μs)
- 2.** The values for the minimum sensing object are representative values that indicate values obtained in Standard Mode with the sensing distance and sensitivity set to the optimum values.

Dimensions

Installation Information → 59 Page

Lens Units (Set of 2)

(26-A) E39-F1

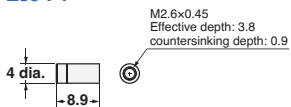

Material: Brass for the body and optical glass for the lens itself.
Note: Two per set.

(26-B) E39-F16

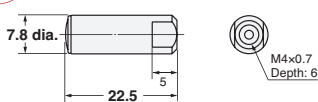

Material: SUS303 for the body and optical glass for the lens itself.
Note: Two per set.

(26-C) E39-F2

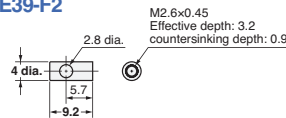

Material: Brass for the body and optical glass for the lens itself.
Note: Two per set.

(26-D) E39-F1-33

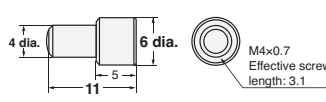

Note 1: Two per set.
Note 2: This is the Lens Unit for the E32-T51.

Dimensions

Installation Information → 58 and 59 Page

Through-beam Fiber Units (Set of 2)

27-A E32-T51R 2M (Free Cutting) + E39-F1

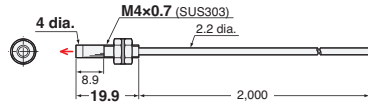

27-B E32-T81R-S 2M (No Cutting) + E39-F1

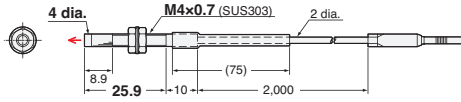

27-C E32-T61-S 2M (No Cutting) + E39-F1

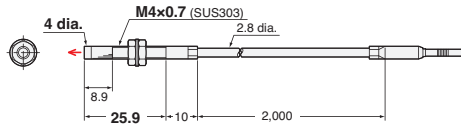

27-G E32-T51R 2M (Free Cutting) + E39-F2

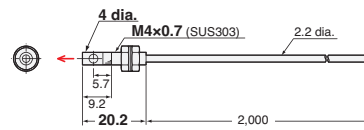

27-H E32-T81R-S 2M (No Cutting) + E39-F2

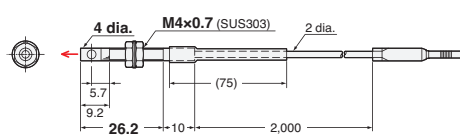

27-I E32-T61-S 2M (No Cutting) + E39-F2

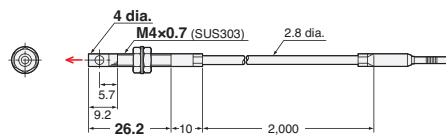

27-D E32-T51R 2M (Free Cutting) + E39-F16

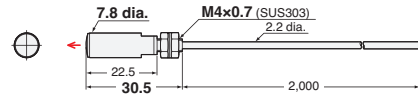

27-E E32-T81R-S 2M (No Cutting) + E39-F16

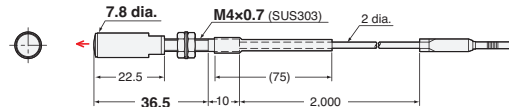

27-F E32-T61-S 2M (No Cutting) + E39-F16

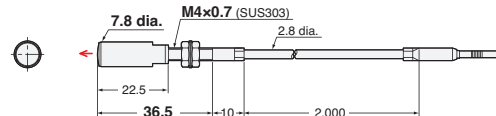

27-J E32-T51 2M (Free Cutting) + E39-F1-33

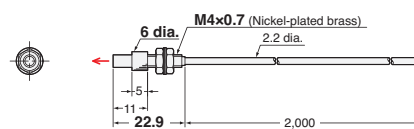

27-K E32-T51 2M (Free Cutting) + E39-F16

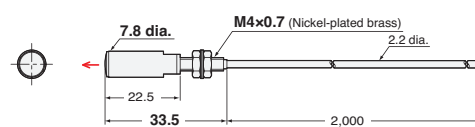

- Reference Information for Model Selection -

Comparisons of incident level

Select the model based on the comparisons of incident level against Standard Fiber Units.

Comparisons of incident level (Through-beam)

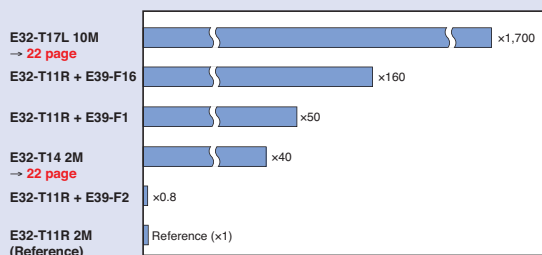

Fiber Sensor Features

Selection Guide

Fiber Units

Threaded

Cylindrical

Flat

Sleeved

Small Spot

High Power

Narrow view

BGS

Retro-reflective

Limited-reflective

Chemical-resistant, Oil-resistant

Bending

Heat-resistant

Area Detection

Liquid-level

Vacuum

FPD, Semi, Solar

Installation Information

Fiber Amplifiers, Communications Unit, and Accessories

Technical Guide and Precautions

Model Index

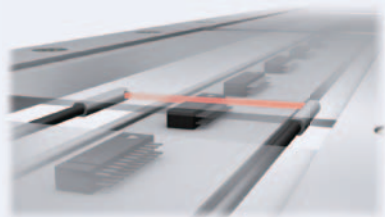

- The fine beam prevents false detection of light that is reflected off surrounding objects.

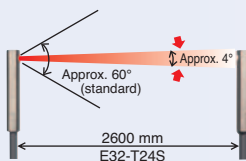

Specifications

Through-beam Fiber Units

Sensing direction	Aperture angle	Appearance (mm)	Bending radius of cable	Sensing distance (mm)			Optical axis diameter (minimum sensing object)	Models	29 Page Dimensions No.	
				Simple Fiber Amplifier Units (Simple Models) E3X-SD	Smart Fiber Amplifier Units (Advanced Models) E3X-HD					
					GIGA	HS				Other modes
Side-View	1.5°	 Thickness: 3 mm IP50	Flexible, R1	890	3,220	ST : 1,780	2 dia. (0.1 dia.)	E32-A03 2M	29-A	
				1,200	SHS: 500	E32-A03-1 2M				29-B
		 Thickness: 3 mm IP50		R10	340	1,280		ST : 680	1.2 dia. (0.1 dia.)	E32-A04 2M
	 Thickness: 2 mm IP50	Flexible, R1	1,170		4,000 *	ST : 2,200	2 dia. (0.1 dia.)	E32-T24SR 2M NEW		29-D
			1,400		1,460	SHS: 580		E32-T24S 2M		29-E
	 Thickness: 2 mm IP50		R10	2,000	4,000 *	ST : 2,600		1.7 dia. (0.1 dia.)	E32-T22S 2M	29-F
		2,500		SHS: 1,000						
Top-View	4°	 15 3 dia IP50								

* The optical fiber is 2 m long on each side, so the sensing distance is 4,000 mm.

Note 1. The mode of E3X-HD that is given under the sensing distances has the following mode names and response times.

GIGA: GIGA Power Mode (16 ms), HS: High-speed Mode (250 μs), ST: Standard Mode (1 ms), and SHS: Super-high-speed Mode (NPN output and E3X-HD0: 50 μs, PNP output: 55 μs)

2. The values for the minimum sensing object are representative values that indicate values obtained in Standard Mode with the sensing distance and sensitivity set to the optimum values.

Threaded

Cylindrical

Flat

Sleeved

Small Spot

High Power

Narrow view

BGS

Retro-reflective

Limited-reflective

Chemical-resistant, Oil-resistant

Bending

Heat-resistant

Area Detection

Liquid-level

Vacuum

Dimensions

Installation Information → 56 and 58 Page

Through-beam Fiber Units (Set of 2)

29-A E32-A03 2M (Free Cutting)

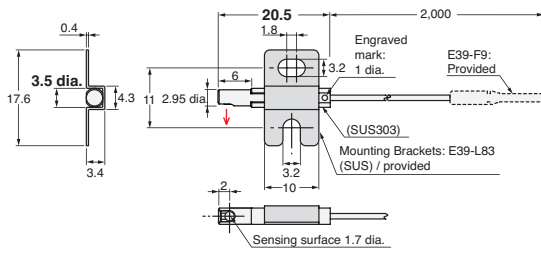

Note: Use the engraved surface and its opposing surface as installation (reference) surfaces.

29-B E32-A03-1 2M (Free Cutting)

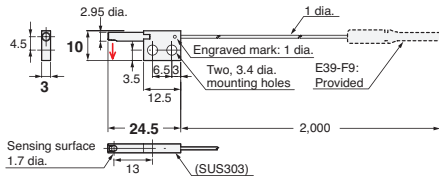

Note 1: Use the engraved surface and its opposing surface as installation (reference) surfaces.
Note 2: Set of two symmetrically shaped Fiber Units.

29-C E32-A04 2M (Free Cutting)

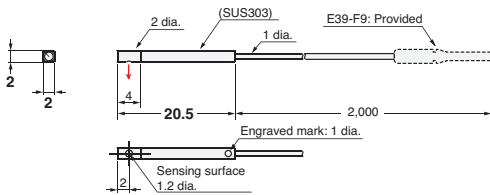

Note: Use the engraved surface and its opposing surface as installation (reference) surfaces.

29-D E32-T24SR 2M (Free Cutting)

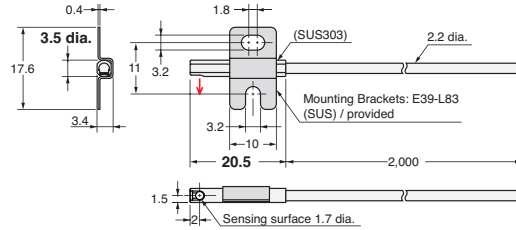

29-E E32-T24S 2M (Free Cutting)

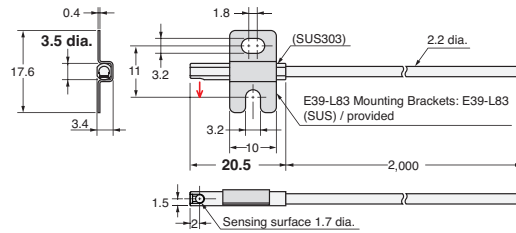

29-F E32-T22S 2M (Free Cutting)

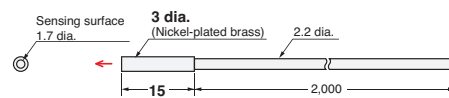

- Reference Information for Model Selection -

Aperture angle and Optical Axis Diameter

The Aperture angle is the output angle of the emitted beam, and the optical axis diameter is the core diameter of the emitter fiber. A fiber with a narrow view has a larger optical axis diameter than standard fibers, but the aperture angle is smaller so it is not influenced by surrounding objects.

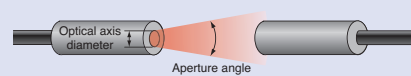

Fiber Sensor Features

Selection Guide

Fiber Units

Threaded

Cylindrical

Flat

Sleeved

Small Spot

High Power

Narrow view

BGS

Retro-reflective

Limited-reflective

Chemical-resistant, Oil-resistant

Bending

Heat-resistant

Area Detection

Liquid-level

Vacuum

FPD, Semi, Solar

Standard Installation

Saving Space

Beam Improvements

Transparent Objects

Environmental Immunity

Applications

Installation Information

Fiber Amplifiers, Communications Unit, and Accessories

Technical Guide and Precautions

Model Index

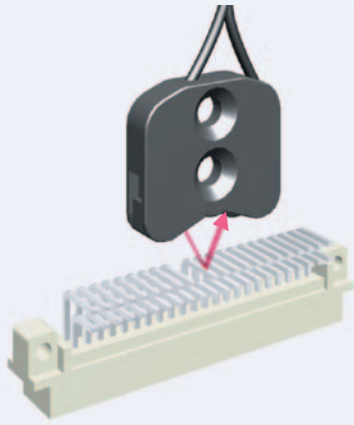

- These Fiber Units detect only objects in the sensing range. Objects in the background that are located beyond a certain point are not detected. They are not easily affected by the material or color of the sensing object.

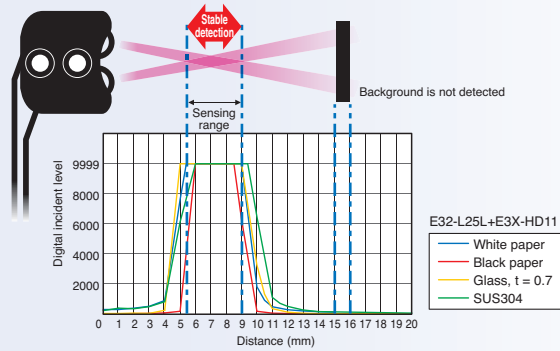

Specifications

Reflective Fiber Units

Sensing direction	Appearance (mm)	Bending radius of cable	Sensing distance (mm)			Standard sensing object (minimum sensing object)	Models	31 Page Dimensions No.
			Simple Fiber Amplifier Units (Simple Models) E3X-SD	Smart Fiber Amplifier Units (Advanced Models) E3X-HD				
				GIGA	HS			
Flat-View		R25	0 to 15	0 to 15	ST : 0 to 15	Soda glass with reflection factor of 7%	E32-L16-N 2M	31-A
		R10	0 to 4	0 to 4	ST : 0 to 4 SHS: 0 to 4			
Side-View		R10	5.4 to 9 (Center: 7.2)	5.4 to 9	ST : 5.4 to 9 SHS: 5.4 to 9		E32-L25L 2M	31-C

- Note 1.** If operation is affected by the background, perform power tuning or use the ECO Mode to decrease the incident light level.
- Note 2.** The mode of E3X-HD that is given under the sensing distances has the following mode names and response times.
GIGA: GIGA Power Mode (16 ms), HS: High-speed Mode (250 μs), ST: Standard Mode (1 ms), and SHS: Super-high-speed Mode (NPN output and E3X-HD0: 50 μs, PNP output: 55 μs)
- Note 3.** The values for the minimum sensing object are representative values that indicate values obtained in Standard Mode with the sensing distance and sensitivity set to the optimum values.
- Note 4.** The sensing distances for Reflective Fiber Units are for white paper.

Dimensions

Installation Information → 57 Page

Reflective Fiber Units

31-A E32-L16-N 2M (Free Cutting)

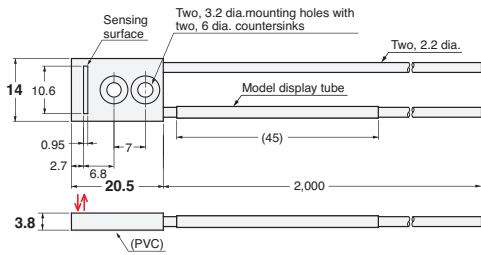

31-B E32-L24S 2M (Free Cutting)

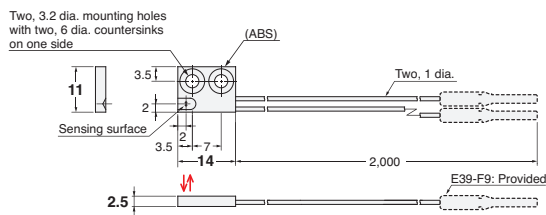

31-C E32-L25L 2M (Free Cutting)

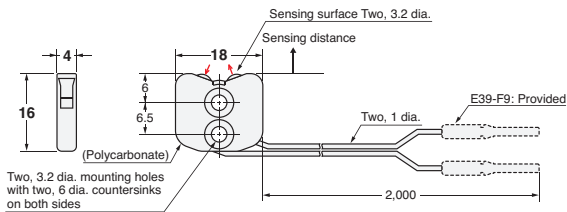

- Reference Information for Model Selection -

Sensing Distance vs. Digital Value

The following graphs show how the digital value is high within the sensing range and small outside. This explains why false detection does not occur outside the sensing range, even against common metal backgrounds, such as stainless steel.

- White paper
- Black paper
- Glass, t = 0.7
- SUS304

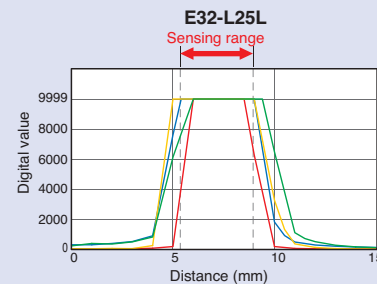
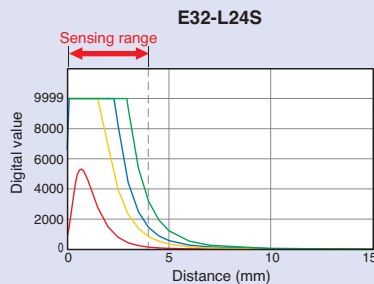
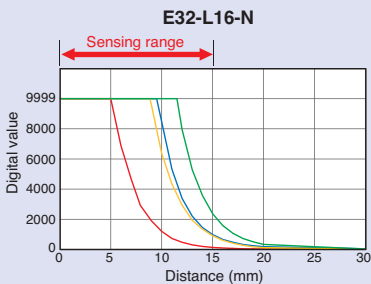

* E3X-HD11 used in High-speed (HS) Mode.

Fiber Sensor Features

Selection Guide

Fiber Units

Threaded

Cylindrical

Flat

Sleeved

Small Spot

High Power

Narrow view

BCS

Retro-reflective

Limited-reflective

Chemical-resistant, Oil-resistant

Bending

Heat-resistant

Area Detection

Liquid-level

Vacuum

FPD, Semi, Solar

Installation Information

Fiber Amplifiers, Communications Unit, and Accessories

Technical Guide and Precautions

Model Index

- Threaded
- Cylindrical

- Flat
- Sleeved

- Small Spot
- High Power
- Narrow view
- BGS

- Retro-reflective
- Limited-reflective

- Chemical-resistant, Oil-resistant
- Bending
- Heat-resistant

- Area Detection
- Liquid-level
- Vacuum
- FPD, Semi, Solar

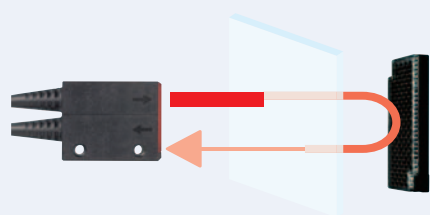

- Retro-reflective Fiber Units are ideal for detecting transparent objects. The light beam passes through the object twice, this model interrupts light more than Through-beam model.

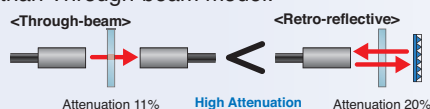

- Excellent detection performance with transparent films. (E32-C31 2M + E39-F3R)
The specially designed filter eliminates undesirable light, which allows significantly more light to be interrupted for stable detection of films.

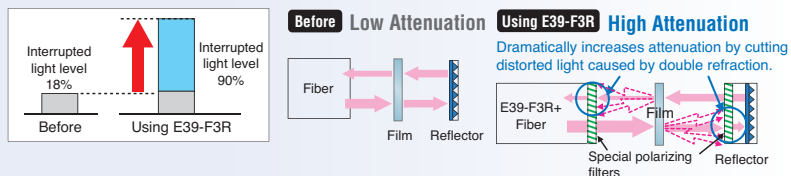

Specifications

Retro-reflective Fiber Units

Type		Appearance (mm)	Bending radius of cable	Sensing distance (mm)			Optical axis diameter (minimum sensing object)	Models	33 Page Dimensions No.
Features	Size			Simple Fiber Amplifier Units (Simple Models) E3X-SD	Smart Fiber Amplifier Units (Advanced Models) E3X-HD				
					GIGA	HS			
Film detection *	M3		R25	220	250, 200	ST : 250	-	E32-C31 2M + E39-F3R + E39-RP37	33-A
Square	-		R25	1,500	150 to 1,500	ST : 150 to 1,500 SHS: 150 to 1,500	(0.2dia.)	E32-R16 5M	33-B
Threaded Models	M6		R10	10 to 250	10 to 250	ST : 10 to 250 SHS: 10 to 250	(0.1dia.)	E32-R21 2M	33-C

* This effect may not be as strong for some films. Detection may be unstable if the object is placed directly in front of the Lens Unit. Check suitability beforehand.

- Note 1.** Objects with a high reflection factor may cause the Fiber Sensor to detect reflected light as incident light.
Note 2. The mode of E3X-HD that is given under the sensing distances has the following mode names and response times.
 GIGA: GIGA Power Mode (16 ms), HS: High-speed Mode (250 μs), ST: Standard Mode (1 ms), and SHS: Super-high-speed Mode (NPN output and E3X-HD0: 50 μs, PNP output: 55 μs)
Note 3. The values for the minimum sensing object are representative values that indicate values obtained in Standard Mode with the sensing distance and sensitivity set to the optimum values.

Dimensions

Installation Information → 56, 58 and 59 Page

Retro-reflective Fiber Units

33-A E32-C31 2M (Free Cutting) + E39-F3R

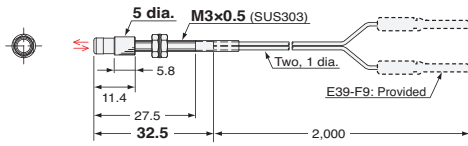

Note: There is a white line on the emitter fiber.

E39-F3R

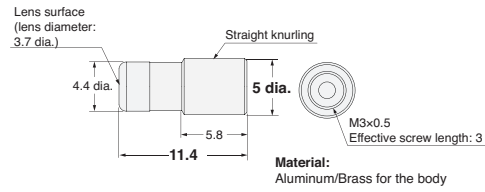

Material:
Aluminum/Brass for the body

E39-RP37

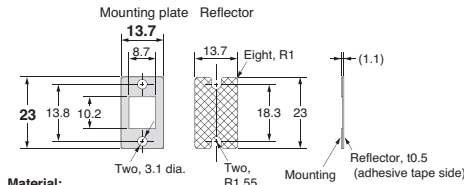

Material:
-Mounting plate> Stainless steel (SUS301)
-Reflector> Methacrylic resin

Note: Set includes one Reflector and one Mounting Plate.

33-B E32-R16 5M (Free Cutting)

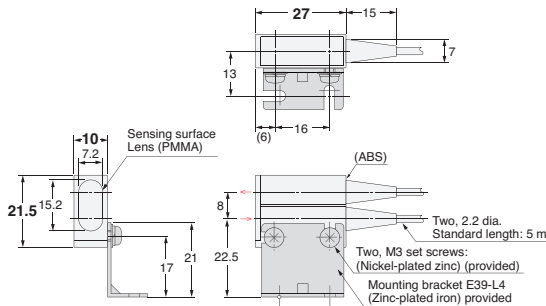

E39-R1 (Provided)

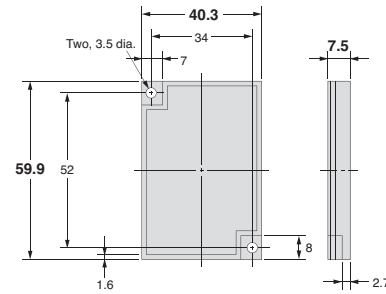

Material:
<Reflective surface>
Methacrylic resin
<Back> ABS

33-C E32-R21 2M (Free Cutting)

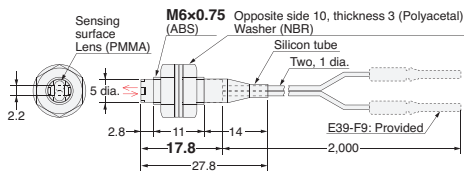

E39-R3 (Provided)

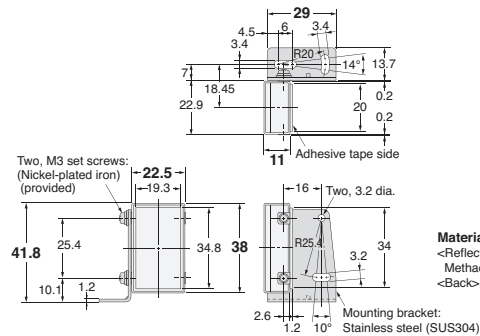

Material:
<Reflective surface>
Methacrylic resin
<Back> ABS

- Reference Information for Model Selection -

Performance Comparison of Transparent Object Detection

For detecting transparent objects, consider using following products together: E32-C31, E39-F3R and E39-RP37.

- This configuration features a special built-in optical filter that ensures stable detection of double-refractive materials, such as films and PET bottles.
- The retro-reflective model is suitable for detecting glass.

We also offer two models with an integrated lens for detecting glass to prevent lens loss.

	Sensing object	Film wrapper on cigarette packs	PET bottles	Glass bottles	Plate glass, t: 0.7
Models					
E32-C31 2M + E39-F3R + E39-RP37		○	○	○	○
E32-R16 5M		△	△	○	○
E32-R21 2M		△	△	○	○

Fiber Sensor Features

Selection Guide

Fiber Units

Threaded

Cylindrical

Flat

Sleeved

Small Spot

High Power

Narrow view

BGS

Retro-reflective

Limited-reflective

Chemical-resistant, Oil-resistant

Bending

Heat-resistant

Area Detection

Liquid-level

Vacuum

FPD, Semi, Solar

Installation Information

Fiber Amplifiers, Communications Unit, and Accessories

Technical Guide and Precautions

Model Index

- Threaded
- Cylindrical

- Flat
- Sleeved

- Small Spot
- High Power
- Narrow view
- BGS

- Retro-reflective
- Limited-reflective

- Chemical-resistant, Oil-resistant
- Bending
- Heat-resistant

- Area Detection
- Liquid-level
- Vacuum
- FPD, Semi, Solar

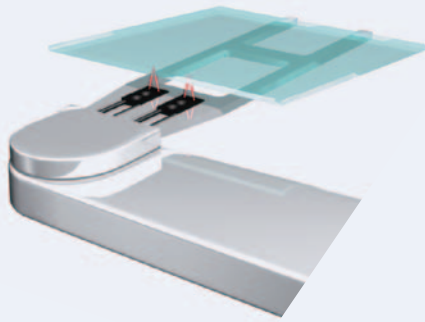

- These Fiber Units are based on a limited-reflective optical system where the emitting light and receiving light axes intersect at the same angle. This allows for stable detection of glass because the Fiber Units receives the specular reflection of the glass when the glass is in the sensing range.

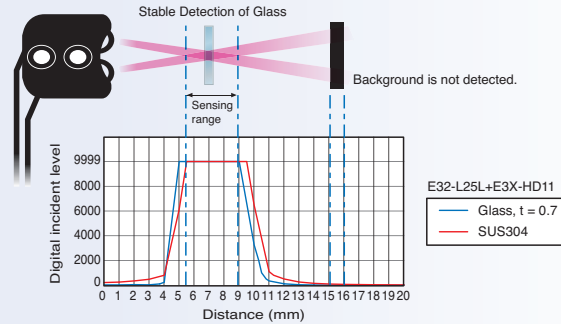

Specifications

Limited-reflective Fiber Units

Type		Appearance (mm)	Bending radius of cable	Sensing distance (mm)			Standard sensing object (minimum sensing object)	Models	35 Page Dimensions No.
Features	Detection direction			Simple Fiber Amplifier Units (Simple Models) E3X-SD	Smart Fiber Amplifier Units (Advanced Models) E3X-HD				
					GIGA HS	Other modes			
Small size	Flat-View		R10	0 to 4	0 to 4	ST : 0 to 4 SHS: 0 to 4	(5 μm dia.)	E32-L24S 2M	35-A
			R25	0 to 15	0 to 15	ST : 0 to 15 SHS: 0 to 12	Soda glass with reflection factor of 7%	E32-L16-N 2M	35-B
Standard long distance	Flat-View		R25	10 to 20	10 to 20	ST : 10 to 20 SHS: —		E32-A08 2M	35-C
			R25	12 to 30	12 to 30	ST : 12 to 30 SHS: —		E32-A12 2M	35-D
Side View form	Side-View		R10	5.4 to 9 (Center 7.2)	5.4 to 9 (Center 7.2) 5.4 to 9 (Center 7.2)	ST : 5.4 to 9 (Center 7.2) SHS: 5.4 to 9 (Center 7.2)	(5 μm dia.)	E32-L25L 2M	35-E
Glass-substrate Mapping, 70°C	Top-View		R25	15 to 38 (Center 25)	15 to 38 (Center 25) 15 to 38 (Center 25)	ST : 15 to 38 (Center 25) SHS: —	End surface of soda glass with reflection factor of 7% (t = 0.7 mm, rounded edges)	E32-A09 2M	35-F

* If the background influences the sensing accuracy, perform power tuning or use the ECO Mode to decrease the incident light level.

Note 1. The mode of E3X-HD that is given under the sensing distances has the following mode names and response times.

GIGA: GIGA Power Mode (16 ms), HS: High-speed Mode (250 μs), ST: Standard Mode (1 ms), and SHS: Super-high-speed Mode (NPN output and E3X-HD0: 50 μs, PNP output: 55 μs)

2. The values for the minimum sensing object are representative values that indicate values obtained in Standard Mode with the sensing distance and sensitivity set to the optimum values.

3. The sensing distances for Reflective Fiber Units are for white paper.

Dimensions

Installation Information → 56 and 57 Page

Limited-reflective Fiber Units

35-A E32-L24S 2M (Free Cutting)

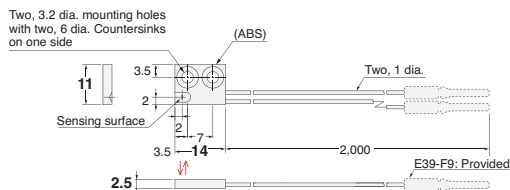

35-B E32-L16-N 2M (Free Cutting)

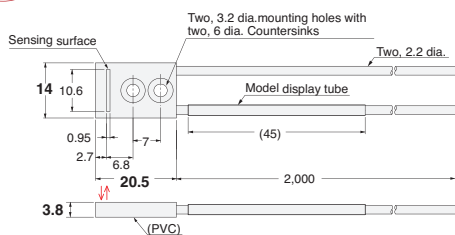

35-C E32-A08 2M (Free Cutting)

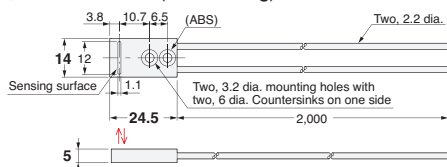

35-D E32-A12 2M (Free Cutting)

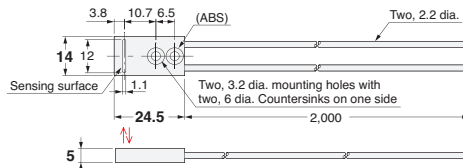

35-E E32-L25L 2M (Free Cutting)

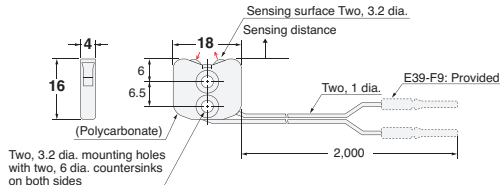

35-F E32-A09 2M (Free Cutting)

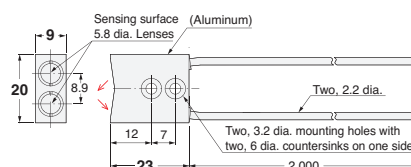

- Reference Information for Model Selection -

Sensing Distance vs. Digital Value

Limited-reflective Fiber Unit can keep high digital value within the sensing area for glass.
The digital value gets lower out of the sensing area for metals, including SUS (common as background).

— Glass, t = 0.7
— SUS304

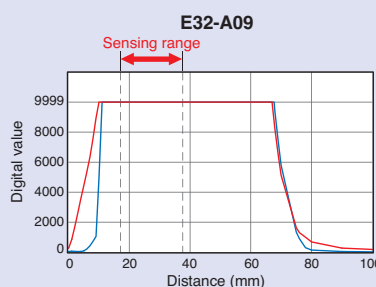
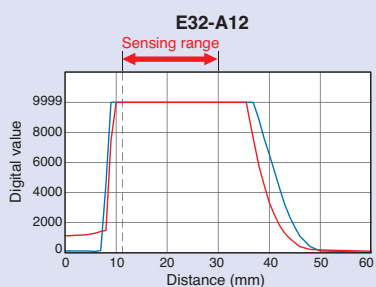
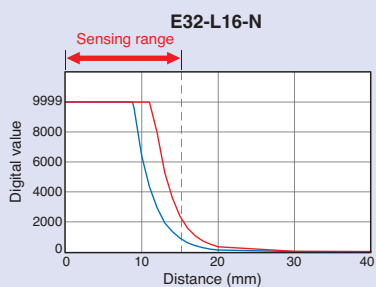
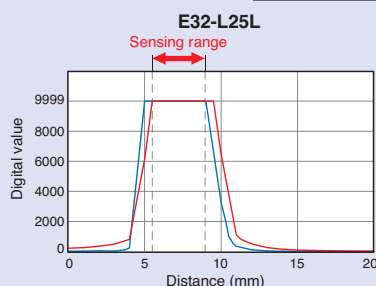
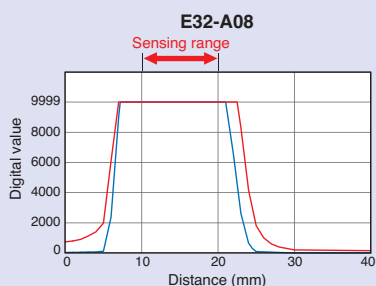
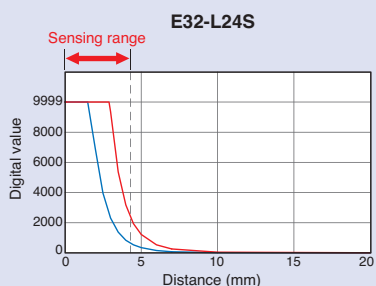

* E3X-HD11 used in High-speed (HS) Mode.

Fiber Sensor Features

Selection Guide

Fiber Units

Threaded	Standard Installation
Cylindrical	Standard Installation
Flat	Saving Space
Sleeved	Saving Space
Small Spot	Beam Improvements
High Power	Beam Improvements
Narrow view	Beam Improvements
BGS	Beam Improvements

Retro-reflective	Transparent Objects
Limited-reflective	Transparent Objects

Chemical-resistant, Oil-resistant	Environmental Immunity
Bending	Environmental Immunity
Heat-resistant	Environmental Immunity

Area Detection	Applications
Liquid-level	Applications
Vacuum	Applications
FPD, Semi, Solar	Applications

Installation Information

Fiber Amplifiers, Communications Unit, and Accessories

Technical Guide and Precautions

Model Index

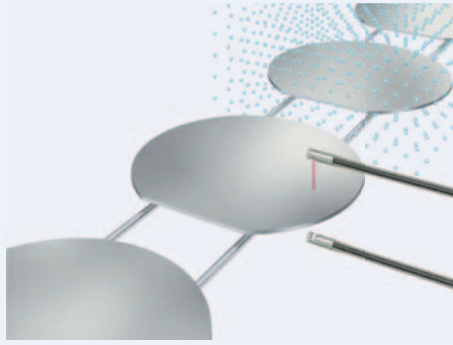

• These Fiber Units are made from fluoro resin for resistance to chemicals.

Chemical-resistant Data for Fluoro resin (Reference)

Material	Fluoro resin	Acryl	ABS	Polycarbonate	Polyethylene	PVC
Hydrochloric acid	○	△	△	△	△	×
Sulfuric acid	○	×	×	×	×	×
Sodium hydroxide	○	△	△	×	○	×
Methyl alcohol	○	×	△	×	○	×
Acetone	○	×	×	×	△	×
Toluene	○	△	×	×	△	×
Benzene	○	△	△	×	△	×

Note: Results depend on concentration.

Specifications

Through-beam Fiber Units

Type	Sensing direction	Appearance (mm)	Bending radius of cable	Sensing distance (mm)			Optical axis diameter (minimum sensing object)	Models	37 Page Dimensions No.
				Simple Fiber Amplifier Units (Simple Models) E3X-SD	Smart Fiber Amplifier Units (Advanced Models) E3X-HD				
					■ GIGA ■ HS	Other modes			
Oil-resistant	Right-angle		Flexible, R1	4,000 *1	4,000 *1	ST : 4,000 *1 SHS: 2,200	4 dia. (0.1 dia.)	E32-T11NF 2M NEW	37-A
Chemical/oil resistant	Top-view		R40	3,200	4,000 *1	ST : 4,000 *1 SHS: 1,600	4 dia. (0.1 dia.)	E32-T12F 2M	37-B
Chemical/oil resistant	Side-view		R4	2,100	4,000 *1	ST : 4,000 *1 SHS: 1,000	3 dia. (0.1 dia.)	E32-T11F 2M	37-C
Chemical/oil resistant 150°C *2	Top-view		R40	400	1,400	ST : 800 SHS: 200	3 dia. (0.1 dia.)	E32-T14F 2M	37-D
Chemical/oil resistant 150°C *2	Top-view		R40	1,400	4,000 *1	ST : 2,800 SHS: 700	4 dia. (0.1 dia.)	E32-T51F 2M	37-E

*1 The optical fiber is 2 m long on each side, so the sensing distance is 4,000 mm.

*2 For continuous operation, use the Fiber Unit between -40 and 130°C.

Reflective Fiber Units

Type	Sensing direction	Appearance (mm)	Bending radius of cable	Sensing distance (mm)			Standard sensing object (minimum sensing object)	Models	37 Page Dimensions No.
				Simple Fiber Amplifier Units (Simple Models) E3X-SD	Smart Fiber Amplifier Units (Advanced Models) E3X-HD				
					■ GIGA ■ HS	Other modes			
Semiconductors: Cleaning, developing, and etching, 60°C	Top-view		R40	8 to 20 mm from tip of Lens (Recommended sensing distance: 11 mm) 19 to 31 mm from center of mounting hole A (Recommended sensing distance: 22 mm)	130	ST : 190 SHS: 60	Glass (t=0.7 mm)	E32-L11FP 5M	37-F
Semiconductors: Resist stripping, 85°C	Top-view		R40	8 to 20 mm from tip of Lens (Recommended sensing distance: 11 mm) 32 to 44 mm from center of mounting hole A (Recommended sensing distance: 35 mm)	130	ST : 190 SHS: 60	Glass (t=0.7 mm)	E32-L11FS 5M	37-G
Chemical/oil resistant	Top-view		R40	100	130	ST : 190 SHS: 60	5 μm dia.)	E32-D12F 2M	37-H
Only cable: chemical resistant	Top-view		R4	180	840	ST : 350 SHS: 100	5 μm dia.)	E32-D11U 2M	37-I

Note 1. The mode of E3X-HD that is given under the sensing distances has the following mode names and response times.

GIGA: GIGA Power Mode (16 ms), HS: High-speed Mode (250 μs), ST: Standard Mode (1 ms), and SHS: Super-high-speed Mode (NPN output and E3X-HD0: 50 μs, PNP output: 55 μs)

2. The values for the minimum sensing object are representative values that indicate values obtained in Standard Mode with the sensing distance and sensitivity set to the optimum values.

3. The sensing distances for Reflective Fiber Units are for white paper.

Dimensions

Installation Information → 58 Page

Installation Information → 56 and 57 Page

Through-beam Fiber Units (Set of 2)

Reflective Fiber Units

37-A E32-T11NF 2M (Free Cutting)

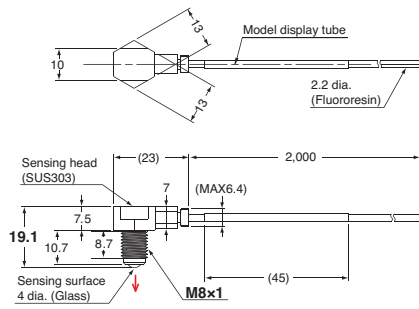

37-B E32-T12F 2M (Free Cutting)

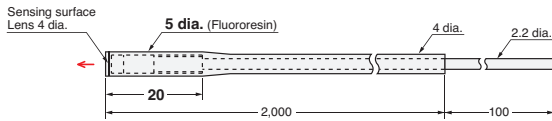

37-C E32-T11F 2M (Free Cutting)

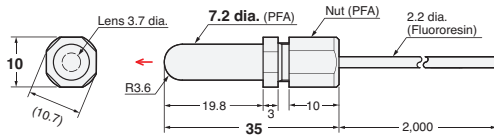

37-D E32-T14F 2M (Free Cutting)

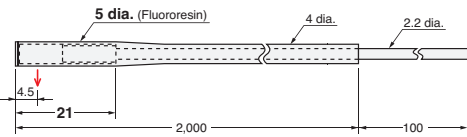

37-E E32-T51F 2M (Free Cutting)

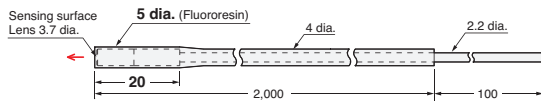

37-F E32-L11FP 5M (Free Cutting)

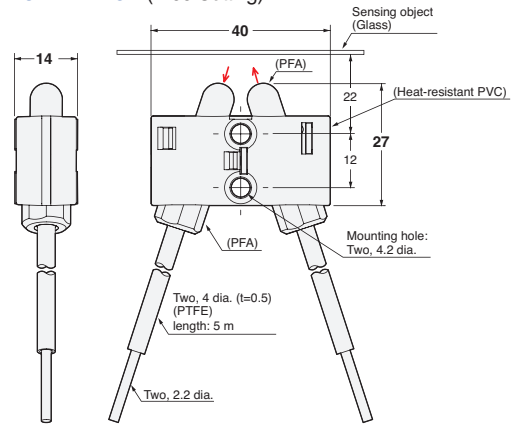

37-G E32-L11FS 5M (Free Cutting)

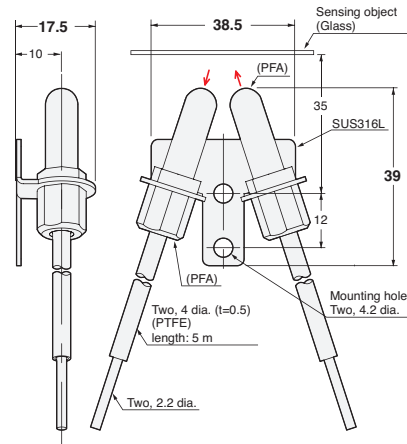

37-H E32-D12F 2M (Free Cutting)

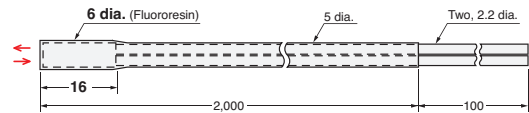

37-I E32-D11U 2M (Free Cutting)

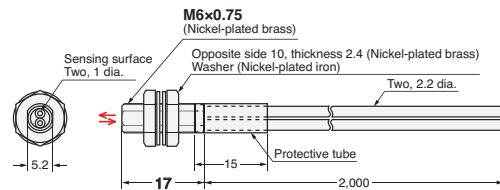

Fiber Sensor Features

Selection Guide

Fiber Units

Threaded

Cylindrical

Flat

Sleeved

Small Spot

High Power

Narrow view

BGS

Retro-reflective

Limited-reflective

Chemical-resistant, Oil-resistant

Bending

Heat-resistant

Area Detection

Liquid-level

Vacuum

FPD, Semi, Solar

Installation Information

Fiber Amplifiers, Communications Unit, and Accessories

Technical Guide and Precautions

Model Index

- Reference Information for Model Selection -

Oil-resistance performance of the E32-T11NF

This diagram explains why the new E32-T11NF is oil resistant.

Vacuum resin filling to prevent oils from entering.

IP68g protection (See. Note)

A fluororesin cable prevents water or oils from entering.

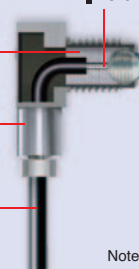

No danger of shorting since no electrical circuits are used.

Note: Equivalent to IP68g of JIS C0920 Annex 1.

Threaded
Cylindrical

Flat
Sleeved

Small Spot
High Power
Narrow view
BGS

Retro-reflective
Limited-reflective

Chemical-resistant, Oil-resistant
Bending
Heat-resistant

Area Detection
Liquid-level
Vacuum
FPD, Semi, Solar

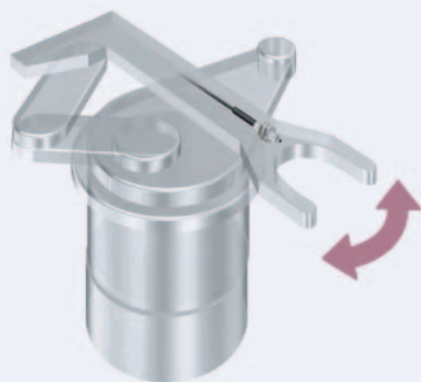

- Capable of withstanding one million repeated bends.

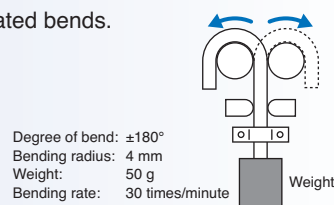

- A large number of independent fine fibers ensures good flexibility. Suitable for use on moving parts without easily breaking.



- Protective Stainless Spiral Tube is available for covering the fiber cable to protect it from accidental breaking due to snagging or shock.

Specifications

Through-beam Fiber Units

Size	Appearance (mm)	Bending radius of cable	Sensing distance (mm)			Optical axis diameter (minimum sensing object)	Models	39 Page Dimensions No.
			Simple Fiber Amplifier Units (Simple Models) E3X-SD	Smart Fiber Amplifier Units (Advanced Models) E3X-HD				
				GIGA	HS			
1.5 dia.		Bend-resistant, R4	200	680	ST : 400	0.5 dia. (5 μm dia.)	E32-T22B 2M	39-A
M3			220		SHS: 90			
M4			720	2,500	ST : 1,350	1 dia. (5 μm dia.)	E32-T11 2M	39-C
Square			150	500	SHS: 360			
				900	ST : 300			
				170	SHS: 70			

Note 1. The mode of E3X-HD that is given under the sensing distances has the following mode names and response times.
GIGA: GIGA Power Mode (16 ms), HS: High-speed Mode (250 μs), ST: Standard Mode (1 ms), and SHS: Super-high-speed Mode (NPN output and E3X-HD0: 50 μs, PNP output: 55 μs)
2. The values for the minimum sensing object are representative values that indicate values obtained in Standard Mode with the sensing distance and sensitivity set to the optimum values.

Protective Stainless Spiral Tube (Sold separately)

Insert the fiber cable into the protective tube to prevent breaking by snagging or shock.

Applicable Fiber Units	Model	Quantity	39 Page Dimensions No.
E32-T11R 2M/E32-T11 2M/ E32-T51R 2M/E32-T51 2M	E39-F32C	2 pieces	39-E

* This Tube cannot be used if a Lens Unit is being used.

Dimensions

Installation Information → 58 and 59 Page

Through-beam Fiber Units (Set of 2)

39-A E32-T22B 2M (Free Cutting)

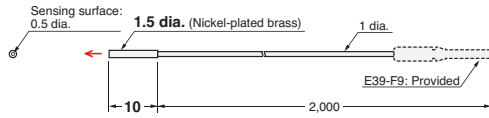

39-D E32-T25XB 2M (Free Cutting)

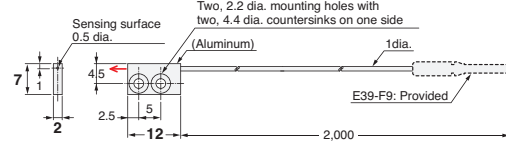

Note 1: Set of two symmetrically shaped Fiber Units.
Note 2: Four, M2 x 8 stainless steel countersunk mounting screws are provided.

39-B E32-T21 2M (Free Cutting)

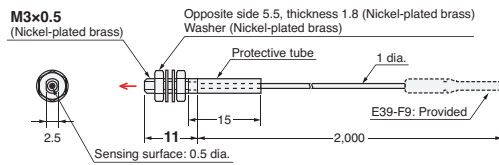

39-E E39-F32C

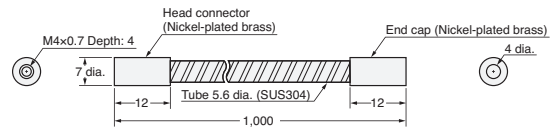

39-C E32-T11 2M (Free Cutting)

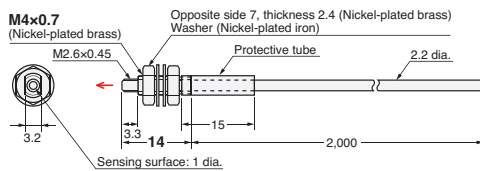

Fiber Sensor Features	
Selection Guide	
Fiber Units	
Threaded	Standard Installation
Cylindrical	
Flat	Saving Space
Sleeved	
Small Spot	Beam Improvements
High Power	
Narrow view	
BGS	
Retro-reflective	Transparent Objects
Limited-reflective	
Chemical-resistant, Oil-resistant	Environmental Immunity
Bending	
Heat-resistant	
Area Detection	Applications
Liquid-level	
Vacuum	
FPD, Semi, Solar	
Installation Information	
Fiber Amplifiers, Communications Unit, and Accessories	
Technical Guide and Precautions	
Model Index	

Threaded
Cylindrical

Flat
Sleeved

Small Spot
High Power
Narrow view
BGS

Retro-reflective
Limited-reflective

Chemical-resistant, Oil-resistant
Bending
Heat-resistant

Area Detection
Liquid-level
Vacuum
FPD, Semi, Solar

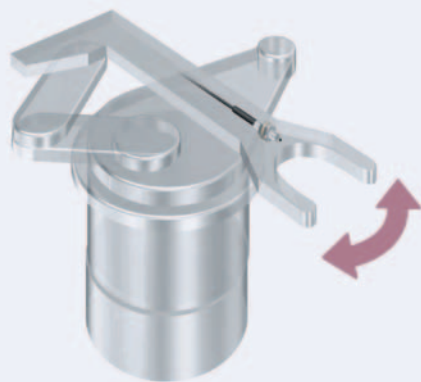

- Capable of withstanding one million repeated bends.

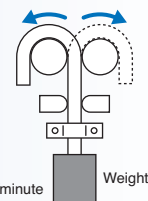

- A large number of independent fine fibers ensures good flexibility. Suitable for use on moving parts without easily breaking.



- Protective Stainless Spiral Tube is available for covering the fiber cable to protect it from accidental breaking due to snagging or shock.

Specifications

Reflective Fiber Units

Size	Appearance (mm)	Bending radius of cable	Sensing distance (mm)			Optical axis diameter (minimum sensing object)	Models	41 Page Dimensions No.
			Simple Fiber Amplifier Units (Simple Models) E3X-SD	Smart Fiber Amplifier Units (Advanced Models) E3X-HD				
				GIGA	HS			
1.5 dia.		Bend-resistant, R4	30	140	ST : 60	(5 μm dia.)	E32-D22B 2M	41-A
M3			40		SHS: 16		E32-D21 2M	41-B
3 dia.			70	300	ST : 140		E32-D221B 2M	41-C
M4			90		SHS: 40		E32-D21B 2M	41-D
M6			180	840	ST : 350		E32-D11 2M	41-E
Square			50	240	ST : 100		E32-D25XB 2M	41-F

- Note 1. The mode of E3X-HD that is given under the sensing distances has the following mode names and response times.
 GIGA: GIGA Power Mode (16 ms), HS: High-speed Mode (250 μs), ST: Standard Mode (1 ms), and SHS: Super-high-speed Mode (NPN output and E3X-HD0: 50 μs, PNP output: 55 μs)
 2. The values for the minimum sensing object are representative values that indicate values obtained in Standard Mode with the sensing distance and sensitivity set to the optimum values.
 3. The sensing distances for Reflective Fiber Units are for white paper.

Protective Stainless Spiral Tube (Sold separately)

Insert the fiber cable into the protective tube to prevent breaking by snagging or shock.

Applicable Fiber Units	Models	Quantity	41 Page Dimensions No.
E32-D21R 2M/E32-C31 2M/ E32-D21 2M	E39-F32A	1 piece	41-G
E32-D211R 2M/E32-D21B 2M	E39-F32C	2 pieces	
E32-D11R 2M/E32-CC200 2M/ E32-D11 2M/E32-D51R 2M/ E32-D51 2M	E39-F32D	1 piece	

* This Tube cannot be used if a Lens Unit is being used.

Dimensions

Installation Information → 56, 57 and 59 Page

Reflective Fiber Units

41-A E32-D22B 2M (No Cutting)

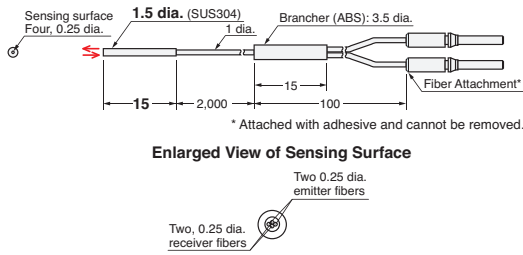

41-B E32-D21 2M (Free Cutting)

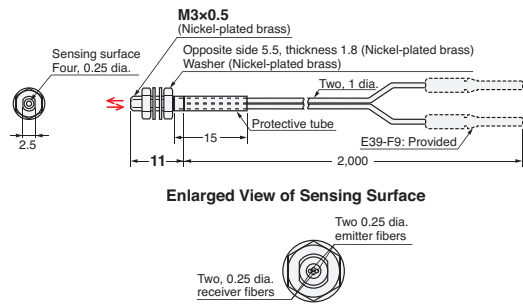

41-C E32-D221B 2M (Free Cutting)

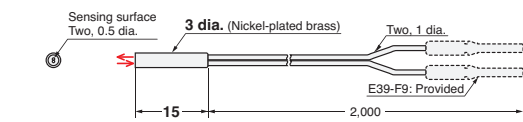

41-D E32-D21B 2M (Free Cutting)

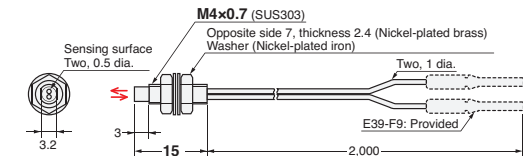

41-E E32-D11 2M (Free Cutting)

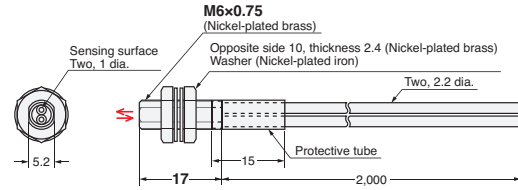

41-F E32-D25XB 2M (Free Cutting)

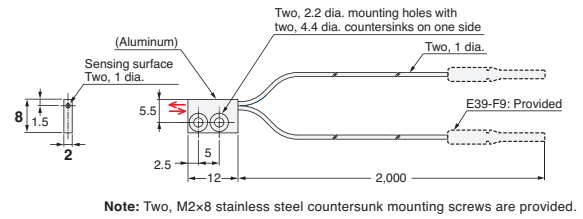

41-G E39-F32A/E39-F32C/E39-F32D

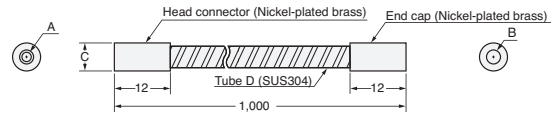

Models	A	B	C	D
E39-F32A	M3x0.5 Depth: 4	3 dia.	6 dia.	(4.6 dia.)
E39-F32C	M4x0.7 Depth: 4	4 dia.	7 dia.	(5.6 dia.)
E39-F32D	M6x0.75 Depth: 4	5 dia.	8.5 dia.	(7 dia.)

Fiber Sensor Features

Selection Guide

Fiber Units

Threaded
Cylindrical

Flat
Sleeved

Small Spot
High Power

Narrow view
BGS

Retro-reflective
Limited-reflective

Chemical-resistant, Oil-resistant
Bending

Heat-resistant
Area Detection

Liquid-level
Vacuum

FPD, Semi, Solar

Installation Information

Fiber Amplifiers, Communications Unit, and Accessories

Technical Guide and Precautions

Model Index

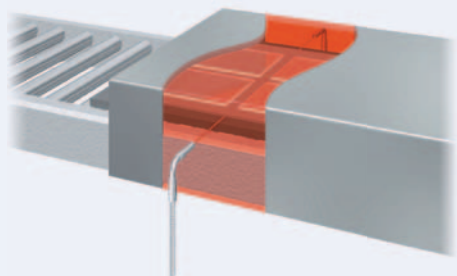

- Wide product variety for temperatures from 100 to 350°C. Select the model according to heat-resistant temperature.

- Standard Installation
- Threaded
 - Cylindrical

- Saving Space
- Flat
 - Sleeved

- Beam Improvements
- Small Spot
 - High Power
 - Narrow view
 - BGS

- Transparent Objects
- Retro-reflective
 - Limited-reflective

- Environmental Immunity
- Chemical-resistant, Oil-resistant
 - Bending
 - Heat-resistant

- Applications
- Area Detection
 - Liquid-level
 - Vacuum
 - FPD, Semi, Solar

- Installation Information

- Fiber Amplifiers, Communications Unit, and Accessories

- Technical Guide and Precautions

- Model Index

Specifications

Through-beam Fiber Units

Heat-resistant temperature	Appearance (mm)	Bending radius of cable	Sensing distance (mm)			Optical axis diameter (minimum sensing object)	Models	43 Page Dimensions No.
			Simple Fiber Amplifier Units (Simple Models) E3X-SD	Smart Fiber Amplifier Units (Advanced Models) E3X-HD				
				GIGA	HS			
100°C *1		Flexible, R2	400	1,600 560	ST : 800 SHS: 225	1 dia. (0.1 dia.)	E32-T51R 2M	43-A
150°C *2		R35	800	2,800 1,000	ST : 1,500 SHS: 400	1.5 dia. (0.1 dia.)	E32-T51 2M	43-B
200°C *3		R10	360	1,000 360	ST : 550 SHS: 140	0.7 dia. (5 μm dia.)	E32-T81R-S 2M	43-C
350°C *4		R25	600	1,680 600	ST : 900 SHS: 240	1 dia. (5 μm dia.)	E32-T61-S 2M	43-D
70°C							Standard Fiber Units can be used.	—

*1 For continuous operation, use the Fiber Unit between -40 to 90°C.
 *2 For continuous operation, use the Fiber Unit between -40 to 130°C.
 *3 The heat-resistant rating is not the same for all parts of the Fiber Unit. Refer to the dimensions diagrams for details.
 *4 The ambient operating temperature for the E32-T61-S 2M is -60 to 350°C.

Note 1. The mode of E3X-HD that is given under the sensing distances has the following mode names and response times.
 GIGA: GIGA Power Mode (16 ms), HS: High-speed Mode (250 μs), ST: Standard Mode (1 ms), and SHS: Super-high-speed Mode (NPN output and E3X-HD0: 50 μs, PNP output: 55 μs)
2. The values for the minimum sensing object are representative values that indicate values obtained in Standard Mode with the sensing distance and sensitivity set to the optimum values.

Dimensions

Installation Information → 58 and 59 Page

Through-beam Fiber Units (Set of 2)

43-A E32-T51R 2M (Free Cutting)

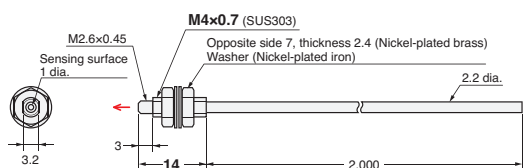

43-B E32-T51 2M (Free Cutting)

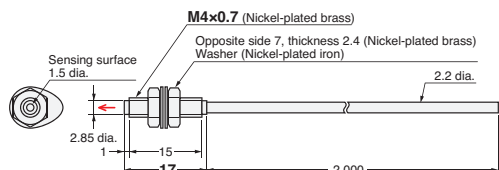

43-C E32-T81R-S 2M (No Cutting)

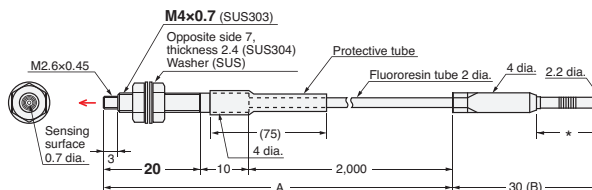

Note: The maximum allowable temperatures for sections A and B are 200°C and 110°C, respectively. The section inserted into the Amplifier Unit (indicated by *) must be maintained within the Amplifier Unit's operating temperature range.

43-D E32-T61-S 2M (No Cutting)

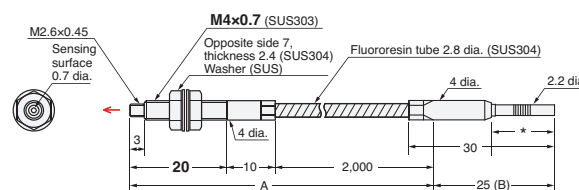

Note: The maximum allowable temperatures for sections A and B are 350°C and 110°C, respectively. The section inserted into the Amplifier Unit (indicated by *) must be maintained within the Amplifier Unit's operating temperature range.

- Reference Information for Model Selection -

And

Long-distance Sensing Applications

A separate Lens Unit can be attached to extend the sensing distance.

→ 26 page

Fiber Sensor Features

Selection Guide

Fiber Units

Threaded	Standard Installation
Cylindrical	
Flat	Saving Space
Sleeved	
Small Spot	Beam Improvements
High Power	
Narrow view	
BGS	Transparent Objects
Retro-reflective	
Limited-reflective	
Chemical-resistant, Oil-resistant	Environmental Immunity
Bending	
Heat-resistant	Applications
Area Detection	
Liquid-level	
Vacuum	
FPD, Semi, Solar	Installation Information
	Fiber Amplifiers, Communications Unit, and Accessories
	Technical Guide and Precautions
	Model Index

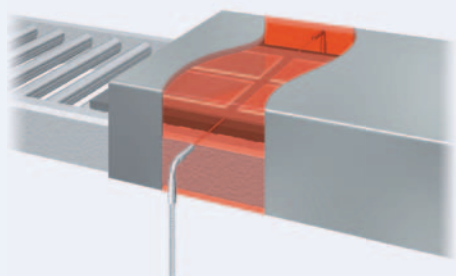

- Wide product variety for temperatures from 100 to 400°C. Select the model according to heat-resistant temperature.

Standard Installation

Threaded
Cylindrical

Saving Space

Flat
Sleeved

Beam Improvements

Small Spot
High Power
Narrow view
BGS

Transparent Objects

Retro-reflective
Limited-reflective

Environmental Immunity

Chemical-resistant, Oil-resistant
Bending
Heat-resistant

Applications

Area Detection
Liquid-level
Vacuum
FPD, Semi, Solar

Installation Information

Fiber Amplifiers, Communications Unit, and Accessories

Technical Guide and Precautions

Model Index

Specifications

Reflective Fiber Units

Heat-resistant temperature	Appearance (mm)	Bending radius of cable	Sensing distance (mm)			Standard sensing object (minimum sensing object)	Models	45 Page Dimensions No.
			Simple Fiber Amplifier Units (Simple Models) E3X-SD	Smart Fiber Amplifier Units (Advanced Models) E3X-HD				
				GIGA	HS			
100°C *1		Flexible, R2	140	670	ST : 280 SHS: 80	(5 μm dia.)	E32-D51R 2M	45-A
150°C *2		R35	240	1,120	ST : 450 SHS: 144		E32-D51 2M	45-B
200°C *3		R10	—	420	ST : 180 SHS: 54		E32-D81R-S 2M	45-C
300°C		R25	10 to 20	10 to 20	ST : 10 to 20 SHS: —	Soda glass with reflection factor of 7%	E32-A08H2 3M	45-D
			20 to 30	20 to 30	ST : 20 to 30 SHS: —	End surface of soda glass with reflection factor of 7% (t = 0.7 mm, rounded edges)	E32-A09H2 2M	45-E
350°C *3		R25	—	420	ST : 180 SHS: 54	(5 μm dia.)	E32-D611-S 2M	45-F
			—	420	ST : 180 SHS: 54		E32-D61-S 2M	45-G
400°C *3		—	—	280	ST : 120 SHS: 36	E32-D73-S 2M	45-H	
70°C	—	—	—	—	—	Standard Fiber Units can be used.	—	

*1 For continuous operation, use the Fiber Unit between -40 to 90°C.
 *2 For continuous operation, use the Fiber Unit between -40 to 130°C.
 *3 The heat-resistant rating is not the same for all parts of the Fiber Unit. Refer to the dimensions diagrams for details.

Note 1. The mode of E3X-HD that is given under the sensing distances has the following mode names and response times.
 GIGA: GIGA Power Mode (16 ms), HS: High-speed Mode (250 μs), ST: Standard Mode (1 ms), and SHS: Super-high-speed Mode (NPN output and E3X-HD0: 50 μs, PNP output: 55 μs)
 2. The values for the minimum sensing object are representative values that indicate values obtained in Standard Mode with the sensing distance and sensitivity set to the optimum values.
 3. The sensing distances for Reflective Fiber Units are for white paper.

Dimensions

Installation Information → 56 and 57 Page

Reflective Fiber Units

45-A E32-D51R 2M (Free Cutting)

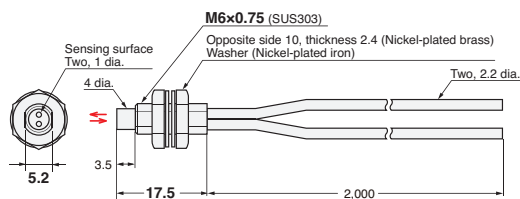

45-B E32-D51 2M (Free Cutting)

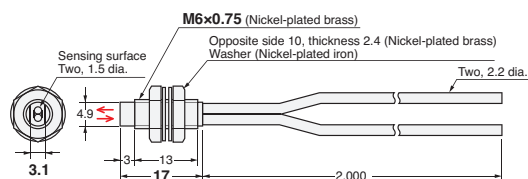

45-C E32-D81R-S 2M (No Cutting)

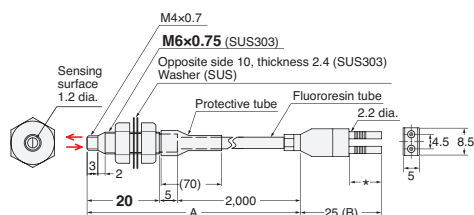

Note: The maximum allowable temperatures for sections A and B are 200°C and 110°C, respectively. The section inserted into the Amplifier Unit (indicated by *) must be maintained within the Amplifier Unit's operating temperature range.

45-D E32-A08H2 3M (No Cutting)

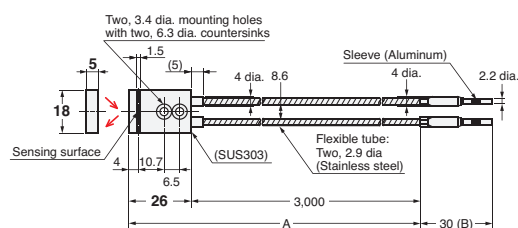

Note: The maximum allowable temperatures for sections A and B are 300°C and 110°C, respectively.

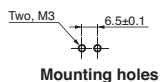

45-E E32-A09H2 2M (No Cutting)

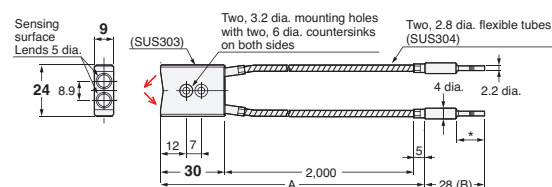

Note: The maximum allowable temperatures for sections A and B are 300°C and 110°C, respectively. The section inserted into the Amplifier Unit (indicated by *) must be maintained within the Amplifier Unit's operating temperature range.

45-F E32-D611-S 2M (No Cutting)

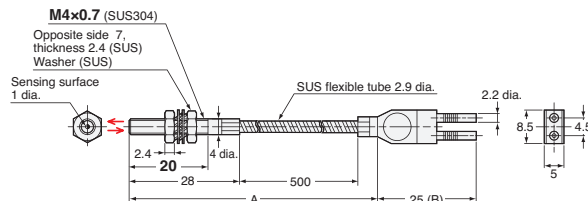

Note: The maximum allowable temperatures for sections A and B are 300°C and 110°C, respectively.

45-G E32-D61-S 2M (No Cutting)

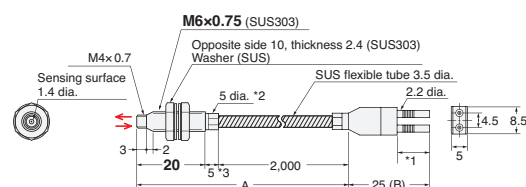

- *2. The diameter is 6 dia. if the fiber length exceeds 10 m.
- *3. The length is 10 if the fiber length exceeds 10 m.

Note: The maximum allowable temperatures for sections A and B are 350°C and 110°C, respectively. The section inserted into the Amplifier Unit (indicated by *) must be maintained within the Amplifier Unit's operating temperature range.

45-H E32-D73-S 2M (No Cutting)

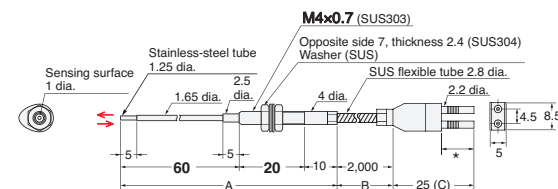

Note: The maximum allowable temperatures for sections A, B, and C are 400°C, 300°C, and 110°C, respectively. The section inserted into the Amplifier Unit (indicated by *) must be maintained within the Amplifier Unit's operating temperature range.

Fiber Sensor
Features

Selection
Guide

Fiber Units

Threaded
Cylindrical

Standard Installation

Flat

Saving Space

Sleeved

Saving Space

Small Spot

Beam Improvements

High Power

Beam Improvements

Narrow
view

Beam Improvements

BGS

Beam Improvements

Retro-
reflective

Transparent Objects

Limited-
reflective

Transparent Objects

Chemical-
resistant,
Oil-resistant

Environmental Immunity

Bending

Environmental Immunity

Heat-
resistant

Environmental Immunity

Area
Detection

Applications

Liquid-level

Applications

Vacuum

Applications

FPD,
Semi,
Solar

Applications

Installation
Information

Fiber Amplifiers,
Communications
Unit, and
Accessories

Technical
Guide and
Precautions

Model Index

Threaded

Cylindrical

Flat

Sleeved

Small Spot

High Power

Narrow view

BGS

Retro-reflective

Limited-reflective

Chemical-resistant, Oil-resistant

Bending

Heat-resistant

Area Detection

Liquid-level

Vacuum

FPD, Semi, Solar

Detection of falling workpieces

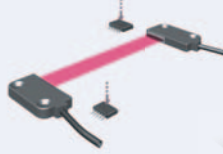

Meander detection

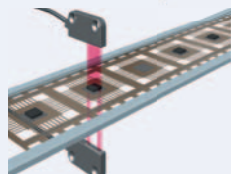
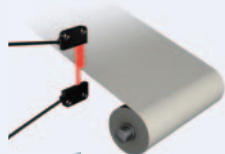

Detection of workpieces with holes

• Area beams are optimum for detecting workpieces presented in inconsistent positions, such as falling workpieces, or for meander detection, or for detecting workpieces with holes.

• This Fiber Unit is ideal for meander detectin because it outputs the digital value in a linear relation to the interrupted light distance.

Characteristics of Light Interruption (Typical)

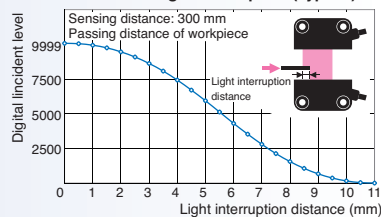

E32-T16PR+E3X-HD11

Specifications

Through-beam Fiber Units

Type	Sensing width	Appearance (mm)	Bending radius of cable	Sensing distance (mm)			Optical axis diameter (minimum sensing object)	Models	47 Page Dimensions No.
				Simple Fiber Amplifier Units (Simple Models) E3X-SD	Smart Fiber Amplifier Units (Advanced Models) E3X-HD				
					GIGA	HS			
Area	11 mm		Flexible, R1	800	3,100	ST : 1,700	(0.2 dia.) *2	E32-T16PR 2M	47-A
				700	1,120	SHS: 440			
	30 mm		1,380	4,000 *1	ST : 2,600	(0.3 dia.) *2	E32-T16WR 2M	47-C	

*1 The optical fiber is 2 m long on each side, so the sensing distance is 4,000 mm.

*2 The values for the minimum sensing object were obtained for detection in the sensing area with the sensing distance set to 300 mm. (The values are for a stationary sensing object.)

Reflective Fiber Units

Type	Sensing width	Appearance (mm)	Bending radius of cable	Sensing distance (mm)			Optical axis diameter (minimum sensing object)	Models	47 Page Dimensions No.
				Simple Fiber Amplifier Units (Simple Models) E3X-SD	Smart Fiber Amplifier Units (Advanced Models) E3X-HD				
					GIGA	HS			
Array	11 mm		Bend-resistant, R4	150	700	ST : 300	(5 μm dia.)	E32-D36P1 2M	47-D
					200	SHS: 90			

Note 1. The mode of E3X-HD that is given under the sensing distances has the following mode names and response times.

GIGA: GIGA Power Mode (16 ms), HS: High-speed Mode (250 μs), ST: Standard Mode (1 ms), and SHS: Super-high-speed Mode (NPN output and E3X-HD0: 50 μs, PNP output: 55 μs)

2. The values for the minimum sensing object are representative values that indicate values obtained in Standard Mode with the sensing distance and sensitivity set to the optimum values.

Dimensions

Installation Information → 58 Page

Installation Information → 57 Page

Through-beam Fiber Units (Set of 2)

47-A E32-T16PR 2M (Free Cutting)

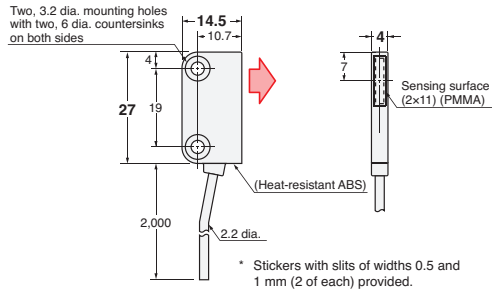

47-B E32-T16JR 2M (Free Cutting)

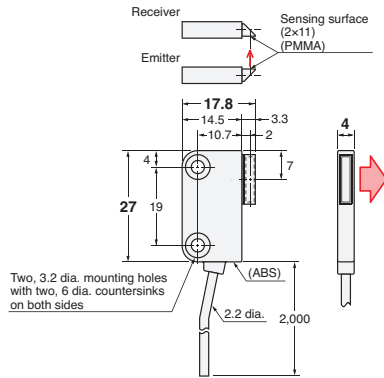

47-C E32-T16WR 2M (Free Cutting)

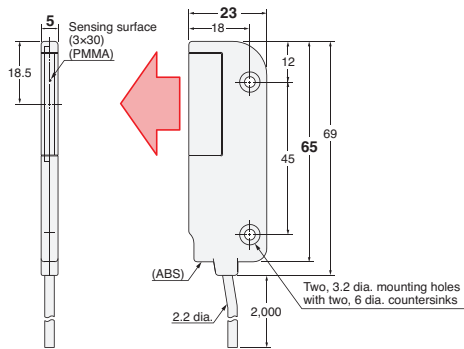

Reflective Fiber Units

47-D E32-D36P1 2M (Free Cutting)

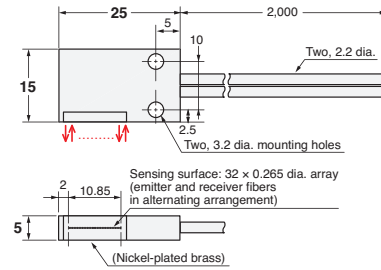

Fiber Sensor Features

Selection Guide

Fiber Units

Threaded

Cylindrical

Flat

Sleeved

Small Spot

High Power

Narrow view

BGS

Retro-reflective

Limited-reflective

Chemical-resistant, Oil-resistant

Bending

Heat-resistant

Area Detection

Liquid-level

Vacuum

FPD, Semi, Solar

Installation Information

Fiber Amplifiers, Communications Unit, and Accessories

Technical Guide and Precautions

Model Index

- Threaded
- Cylindrical

- Flat
- Sleeved

- Small Spot
- High Power
- Narrow view

- Retro-reflective
- Limited-reflective

- Chemical-resistant, Oil-resistant
- Bending
- Heat-resistant

- Area Detection
- Liquid-level
- Vacuum
- FPD, Semi, Solar

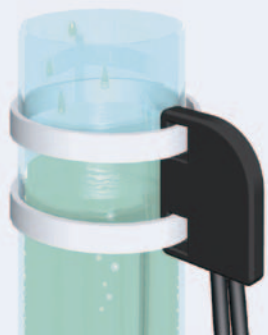

• Fiber Units for detecting liquid levels are available in two types: for tube mounting and liquid contact.

▶ **Tube-mounting Types**

Detect the liquid level inside transparent tubes. Strap the Fiber Unit to a tube with band.



▶ **Liquid-contact Type**

Detect the liquid level by direct contact with the liquid. This model has excellent chemical-resistance because the Fiber Unit is covered in fluororesin.

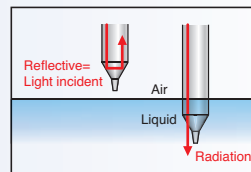

Specifications

Detection scheme	Tube diameter	Features	Appearance (mm)	Bending radius of cable	Applicable range	Optical axis diameter (minimum sensing object)	Models	49 Page Dimensions No.
Tube-mounting	3.2, 6.4 and 9.5 dia.	<ul style="list-style-type: none"> Resistant to bubbles and droplets Residual quantity detection 		Bend-resistant, R4	Applicable tube: Transparent tube with a diameter of 3.2, 6.4, or 9.5 dia. and a recommended wall thickness of 1 mm	—	E32-A01 5M	49-A
	8 to 10 dia.	Ideal for mounting at multilevels		R10	Applicable tube: Transparent tube with a diameter of 8 to 10 dia. and a recommended wall thickness of 1 mm	—	E32-L25T 2M	49-B
	No restrictions	<ul style="list-style-type: none"> Usable on large diameter tubes Resistant to bubbles and droplets 		R4	Applicable tube: Transparent tube (no restrictions on diameter)	—	E32-D36T 5M	49-C
Liquid contact (heat-resistant up to 200°C)	—	—		R40 R25 *3	Liquid-contact Type *1	—	E32-D82F1 4M	49-D

*1 If the incident light level is too high, perform power tuning or use the ECO Mode to decrease the incident level.

*2 The applicable range is the same whether an E3X-HD series or E3X-SD series is used.

When using an E3X-HD Fiber Amplifier Unit in GIGA Power Mode, level detection may not work depending on the tube diameter. Make sure to confirm operation with the actual tube.

*3 The bending radius of the sensing section (except for the unbendable section) is 40 mm, and the bending radius of the fiber is 25 mm.

- Reference Information for Model Selection -

Determining the Best Model for Tube-mounted Types

Mounting and conditions	Recommended Unit	Features
When bubbles and the water droplets are generated	E32-A01	<p>This is a Through-beam Model, so the incident light will differ greatly between with and without of liquid. It also uses an area beam, which is less prone to false detection by bubbles and droplets.</p> <div style="display: flex; justify-content: space-around;"> <div style="text-align: center;"> <p>With liquid</p> <p>Light interrupted</p> </div> <div style="text-align: center;"> <p>Without liquid</p> <p>Light incident</p> </div> </div>
Multilevel installation in limited space	E32-L25T	<p>This model is suitable for mounting at multilevels because of the thin type (height: 10 mm).</p>
Mounting on large diameter tubes	E32-D36T	<p>This model has no restrictions on the tube diameter, so it can be mounted on many different tube sizes. It also uses an area beam, which is less prone to false detection by bubbles and droplets.</p> <div style="display: flex; justify-content: space-around;"> <div style="text-align: center;"> <p>With liquid</p> <p>Reflective= Light incident</p> </div> <div style="text-align: center;"> <p>Without liquid</p> <p>Radiation</p> </div> </div>

Dimensions

Installation Information → 56 and 57 Page

49-A E32-A01 5M (Free Cutting)

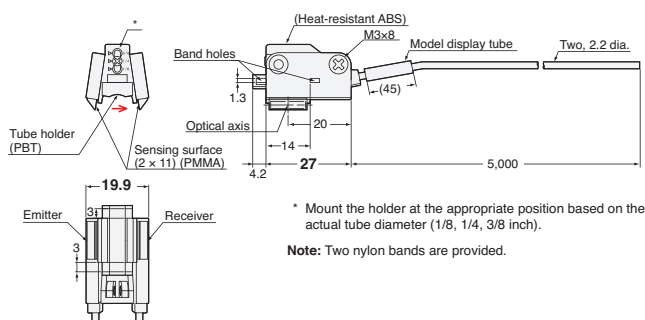

Tube-mounting Examples



49-B E32-L25T 2M (Free Cutting)

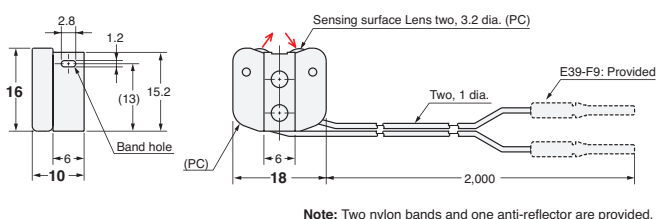

49-C E32-D36T 5M (Free Cutting)

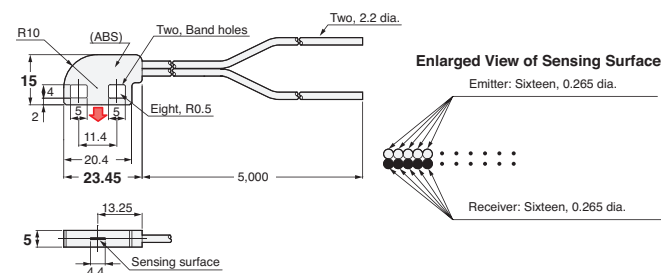

49-D E32-D82F1 4M (Free Cutting)

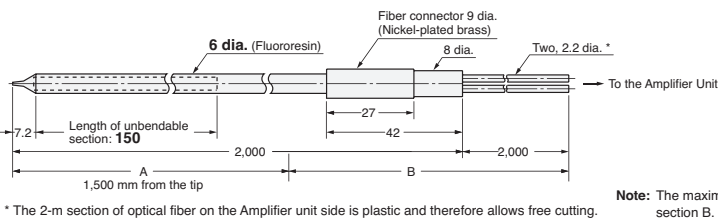

And

Designed for Safe Residual quantity detection (E32-A01 only)

The E32-A01 Fiber Unit is designed to default to the same output as for liquid absent in the event of a failure, such as when the fiber breaks. This makes it suitable for residual quantity detection.

Trouble (disconnection)	Light interrupted
With liquid	Light interrupted
Without liquid	Light incident

If the failure goes unnoticed, this failsafe design will prevent false detection of liquid when there is no liquid present.

Fiber Sensor Features

Selection Guide

Fiber Units

Threaded
Cylindrical
Flat
Sleeved
Small Spot
High Power
Narrow view
BGS

Standard Installation
Saving Space
Beam Improvements
Transparent Objects

Retro-reflective
Limited-reflective
Chemical-resistant, Oil-resistant
Bending
Heat-resistant

Area Detection
Liquid-level
Vacuum
FPD, Semi, Solar

Environmental Immunity

Applications

Installation Information

Fiber Amplifiers, Communications Unit, and Accessories

Technical Guide and Precautions

Model Index

Threaded

Cylindrical

Flat

Sleeved

Small Spot

High Power

Narrow view

BGS

Retro-reflective

Limited-reflective

Chemical-resistant, Oil-resistant

Bending

Heat-resistant

Area Detection

Liquid-level

Vacuum

FPD, Semi, Solar

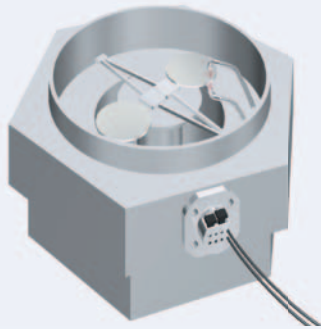

- Can be used under high vacuums of up to 10^{-5} Pa.
- Available in models with heat resistant up to 120 or 200°C.

Configuration Example for using under vacuum

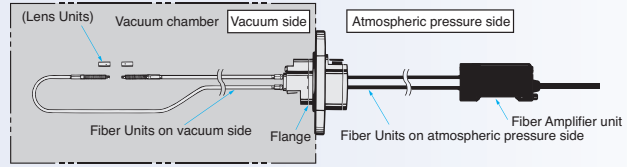

Specifications

Through-beam Fiber Units

Type	Heat-resistant temperature	Appearance (mm)	Bending radius of cable	Sensing distance (mm)			Optical axis diameter (minimum sensing object)	Models	51 Page Dimensions No.
				Simple Fiber Amplifier Units (Simple Models) E3X-SD	Smart Fiber Amplifier Units (Advanced Models) E3X-HD				
					GIGA	HS			
Vacuum side	120°C		R30	200	720 260	ST : 400 SHS: 100	1.2 dia. (10 μm dia.)	E32-T51V 1M	51-A
				1,200	3,780 1,360	ST : 2,000 SHS: 520	4 dia. (0.1 dia.)	E32-T51V 1M + E39-F1V	51-B
	200°C		R25	500	1,760 640	ST : 950 SHS: 260	2 dia. (0.1 dia.)	E32-T84SV 1M	51-C
Atmospheric pressure side	70°C		R25	—	—	ST : — SHS: —	—	E32-T10V 2M	51-D

Note 1. The mode of E3X-HD that is given under the sensing distances has the following mode names and response times. GIGA: GIGA Power Mode (16 ms), HS: High-speed Mode (250 μs), ST: Standard Mode (1 ms), and SHS: Super-high-speed Mode (NPN output and E3X-HD0: 50 μs, PNP output: 55 μs)
2. The values for the minimum sensing object are representative values that indicate values obtained in Standard Mode with the sensing distance and sensitivity set to the optimum values.

Flange

Appearance	Type	Models	51 Page Dimensions No.
	4-channel flange	E32-VF4	51-E
	1-channel flange	E32-VF1	51-F

Dimensions

Installation Information → 58 and 59 Page

Through-beam Fiber Units (Set of 2)

51-A E32-T51V 1M (No Cutting)

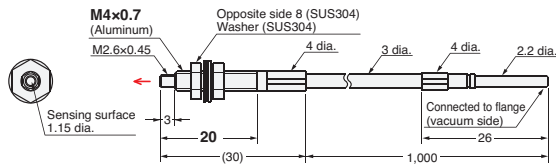

51-B E32-T51V 1M (No Cutting) + E39-F1V

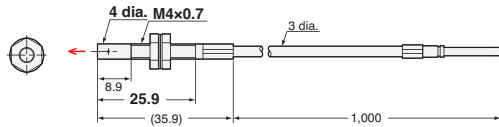

E39-F1V

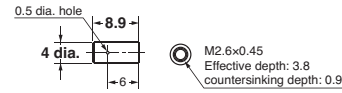

51-C E32-T84SV 1M (No Cutting)

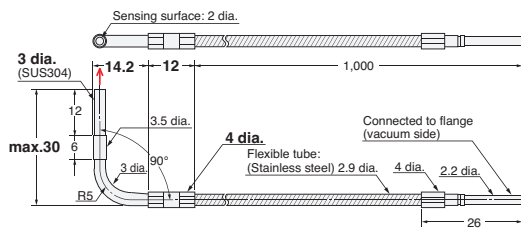

51-D E32-T10V 2M (Free Cutting)

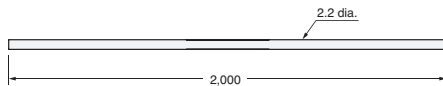

51-E E32-VF4

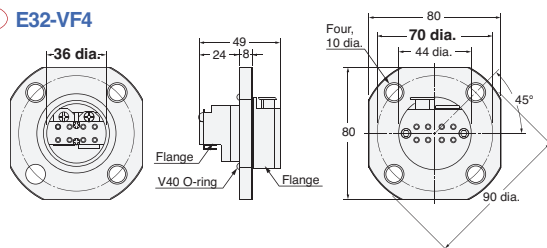

- Note 1. Mount the Flange so that the V40 O-Ring is on the atmospheric-pressure side of the vacuum chamber wall.
2. Mounting-hole dimensions: 38 dia. ±0.5 mm
3. The maximum tightening torque is 9.8 N·m.

51-F E32-VF1

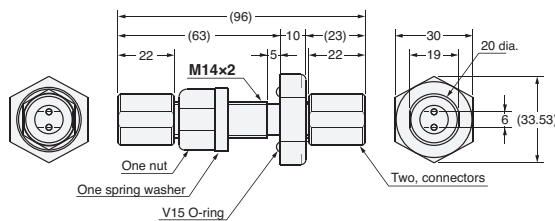

- Note 1. Mount the Flange so that the V15 O-Ring is on the atmospheric-pressure side of the vacuum chamber wall.
2. Mounting-hole dimensions: 14.5 dia. ±0.2 mm
3. The maximum tightening torque is 14.7 N·m for the clamp nut and 1.5 N·m for the connector.

- Reference Information for Model Selection -

What Is a Vacuum-resistant Fiber Unit?

- The Flange is designed to create an air-tight seal on the vacuum side.
- The fibers and Flange on the vacuum side are made of non-outgassing materials. These parts are inspected, cleaned, and sealed in an air-tight package in a clean room prior to shipment.

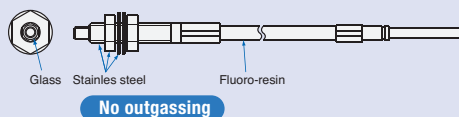

Fiber Sensor Features

Selection Guide

Fiber Units

Threaded

Cylindrical

Flat

Sleeved

Small Spot

High Power

Narrow view

BGS

Retro-reflective

Limited-reflective

Chemical-resistant, Oil-resistant

Bending

Heat-resistant

Area Detection

Liquid-level

Vacuum

FPD, Semi, Solar

Installation Information

Fiber Amplifiers, Communications Unit, and Accessories

Technical Guide and Precautions

Model Index

Fiber Sensor Features

Selection Guide

Fiber Units

Standard Installation

Threaded

Cylindrical

Saving Space

Flat

Sleeved

Beam Improvements

Small Spot

High Power

Narrow view

BGS

Transparent Objects

Retro-reflective

Limited-reflective

Environmental Immunity

Chemical-resistant, Oil-resistant

Bending

Heat-resistant

Applications

Area Detection

Liquid-level

Vacuum

FPD, Semi, Solar

Installation Information

Fiber Amplifiers, Communications Unit, and Accessories

Technical Guide and Precautions

Model Index

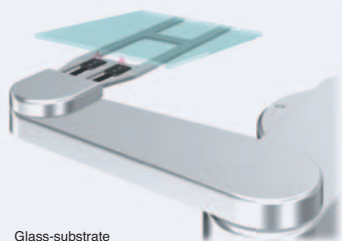

Glass-substrate Alignment

• Glass-substrate Alignment

- ▶ Detection position accuracy: 0.2 mm max. No variation in detection positions even if the sensing distance changes.
- ▶ Tilting workpiece does not affect detection.

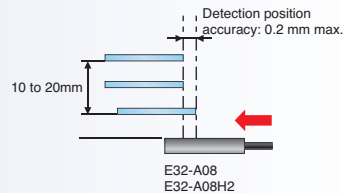

• Glass-substrate Mapping

Stable detection is possible even for difficult-to-detect curved surfaces.

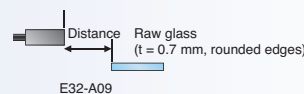
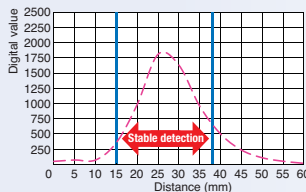

• Glass Presence Detection in Wet Processes

- ▶ Stable non-contact detection even with warped glass.
- ▶ The spherical heads ensure stable detection without being influenced by liquid.

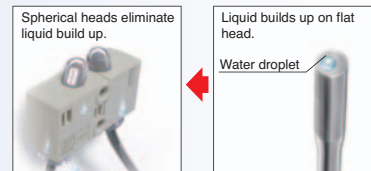

Specifications

Limited-reflective Fiber Units

Application	Ambient temperature	Appearance (mm)	Bending radius of cable	Sensing distance (mm)			Standard sensing object (minimum sensing object)	Models	53 Page Dimensions No.
				Simple Fiber Amplifier Units (Simple Models) E3X-SD	Smart Fiber Amplifier Units (Advanced Models) E3X-HD				
					■ GIGA ■ HS	Other modes			
Glass presence detection	70°C		R25	0 to 15	0 to 15	ST : 0 to 15 SHS: 0 to 12	Soda glass with reflection factor of 7%	E32-L16-N 2M *1	53-A
				10 to 20	10 to 20	ST : 10 to 20 SHS: -		E32-A08 2M *1	53-B
Glass-substrate Alignment	300°C		R25	12 to 30	12 to 30	ST : 12 to 30 SHS: -	End surface of soda glass with reflection factor of 7% (t = 0.7 mm, rounded edges)	E32-A08H2 3M *1	53-C
	70°C			15 to 38 (Center 25)	15 to 38 (Center 25)	ST : 15 to 38 SHS: -		E32-A12 2M NEW	53-D
Mapping of glass substrates	300°C *2		R40	20 to 30 (Center 25)	20 to 30 (Center 25)	ST : 20 to 30 SHS: - (Center 25)		E32-A09 2M	53-E
	70°C			8 to 20 mm from tip of Lens (Recommended sensing distance: 11 mm) 19 to 31 mm from center of mounting hole A (Recommended sensing distance: 22 mm)	8 to 20 mm from tip of Lens (Recommended sensing distance: 11 mm) 32 to 44 mm from center of mounting hole A (Recommended sensing distance: 35 mm)	ST : 8 to 20 mm SHS: -		E32-L11FP 5M	53-G
Wet processes (Cleaning, Resist developing, and etching)	60°C		R40				Glass (t=0.7mm)	E32-L11FP 5M	53-G
Wet processes (Resist stripping)	85°C							E32-L11FS 5M	53-H

*1 If operation is affected by the background, perform power tuning or use the ECO Mode to decrease the incident level.
*2 The maximum allowable temperature is not the same for all parts of the Fiber Unit. Refer to the dimensions diagrams for details. Must not be repeatedly subject to rapid temperature changes.

Note 1. The mode of E3X-HD that is given under the sensing distances has the following mode names and response times.
GIGA: GIGA Power Mode (16 ms), HS: High-speed Mode (250 μs), ST: Standard Mode (1 ms), and SHS: Super-high-speed Mode (NPN output and E3X-HD0: 50 μs, PNP output: 55 μs)

Dimensions

Installation Information → 56 and 57 Page

Limited-reflective Fiber Units

53-A E32-L16-N 2M (Free Cutting)

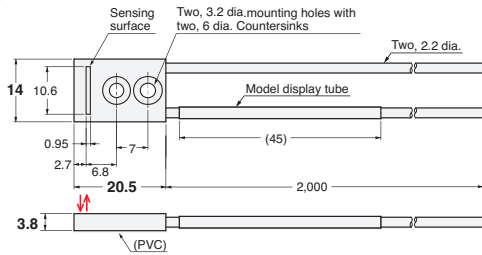

53-B E32-A08 2M (Free Cutting)

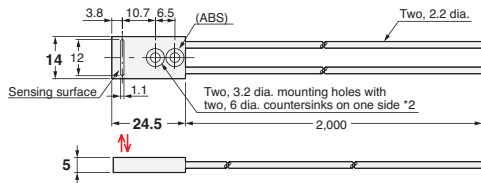

53-C E32-A08H2 3M (No Cutting)

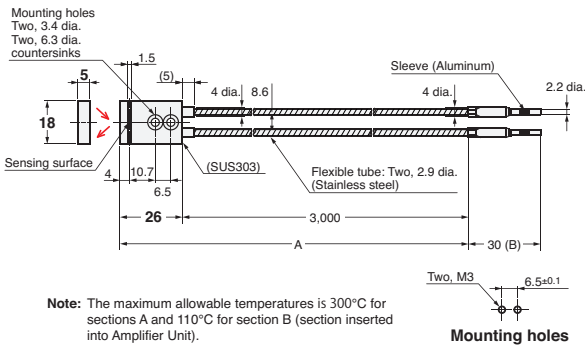

53-D E32-A12 2M (Free Cutting)

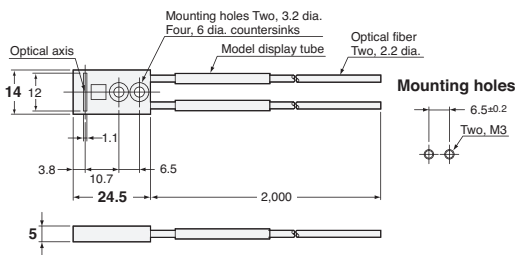

53-E E32-A09 2M (Free Cutting)

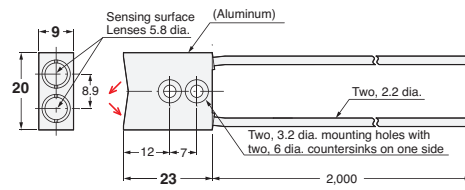

53-F E32-A09H2 2M (No Cutting)

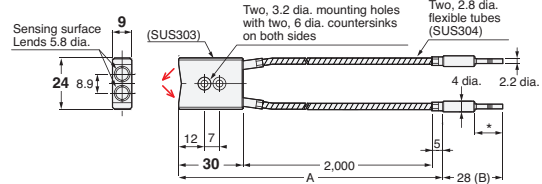

Note: The maximum allowable temperatures for sections A and B are 300°C and 110°C, respectively. The section inserted into the Amplifier Unit (indicated by *) must be maintained within the Amplifier Unit's operating temperature range.

53-G E32-L11FP 5M (Free Cutting)

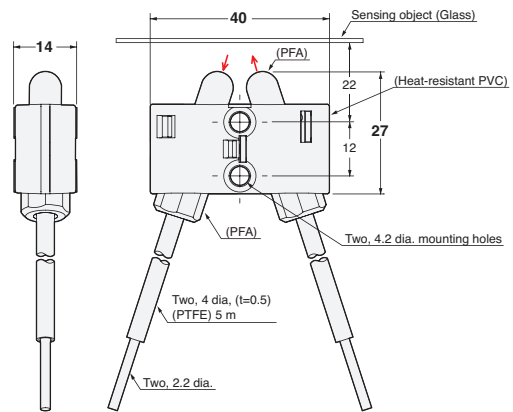

53-H E32-L11FS 5M (Free Cutting)

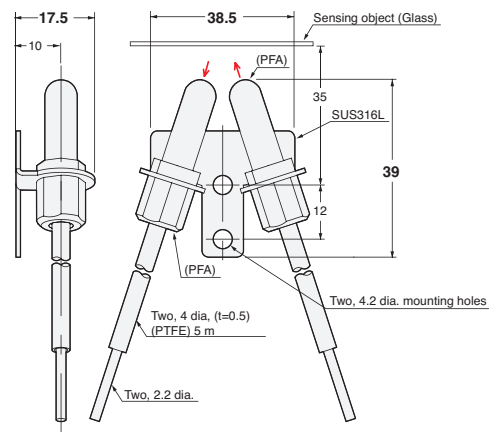

Fiber Sensor Features

Selection Guide

Fiber Units

Threaded

Cylindrical

Flat

Sleeved

Small Spot

High Power

Narrow view

BGS

Retro-reflective

Limited-reflective

Chemical-resistant, Oil-resistant

Bending

Heat-resistant

Area Detection

Liquid-level

Vacuum

FPD, Semi, Solar

Installation Information

Fiber Amplifiers, Communications Unit, and Accessories

Technical Guide and Precautions

Model Index

Fiber Sensor Features

Selection Guide

Fiber Units

Standard Installation

Threaded

Cylindrical

Saving Space

Flat

Sleeved

Beam Improvements

Small Spot

High Power

Narrow view

BGS

Transparent Objects

Retro-reflective

Limited-reflective

Environmental Immunity

Chemical-resistant, Oil-resistant

Bending

Heat-resistant

Applications

Liquid-level

Vacuum

FPD, Semi, Solar

Installation Information

Fiber Amplifiers, Communications Unit, and Accessories

Technical Guide and Precautions

Model Index

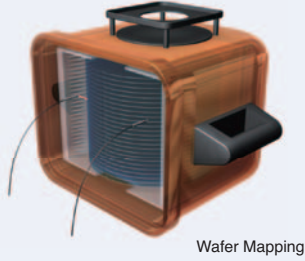

Wafer Mapping

• Wafer Mapping

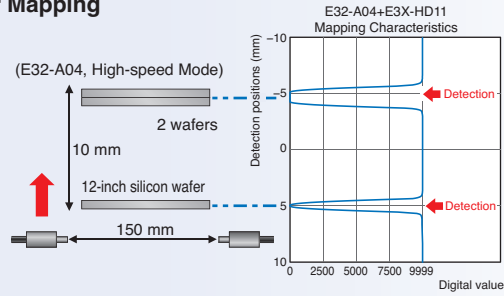

- ▶ Thin-profile design enables easy mounting on robot arms.
- ▶ Easy to adjust optical axis.
(Typical alignment error between mechanical and optical axes is only $\pm 0.1^\circ$.)
- ▶ Reliably wafer detection, even when stacked closely together.

Specifications

Through-beam Fiber Units

Application	Ambient temperature	Aperture angle	Appearance (mm)	Bending radius of cable	Sensing distance (mm)			Optical axis diameter (minimum sensing object)	Models	55 Page Dimensions No.
					Simple Fiber Amplifier Units (Simple Models) E3X-SD	Smart Fiber Amplifier Units (Advanced Models) E3X-HD				
						GIGA	HS			
Wafer Mapping	70°C	1.5°	 Thickness: 3 mm IP50	Flexible, R1	890	3,220	ST : 1,780 SHS: 500	2 dia. (0.1 dia.)	E32-A03 2M	55-A
			 Thickness: 3 mm IP50							
		 Thickness: 2 mm IP50	Flexible, R1	1,170	4,000* 1,460	ST : 2,200 SHS: 580	2 dia. (0.1 dia.)	E32-A04 2M	55-C	
		 3.5 dia. IP50								R10
								E32-T24S 2M	55-E	

* The optical fiber is 2 m long on each side, so the sensing distance is 4,000 mm.

Note 1. The mode of E3X-HD that is given under the sensing distances has the following mode names and response times.

GIGA: GIGA Power Mode (16 ms), HS: High-speed Mode (250 μ s), ST: Standard Mode (1 ms), and SHS: Super-high-speed Mode (NPN output and E3X-HD0: 50 μ s, PNP output: 55 μ s)

Note 2. The values for the minimum sensing object are representative values that indicate values obtained in Standard Mode with the sensing distance and sensitivity set to the optimum values.

Dimensions

Installation Information → 56 and 58 Page

Through-beam Fiber Units (Set of 2)

55-A E32-A03 2M (Free Cutting)

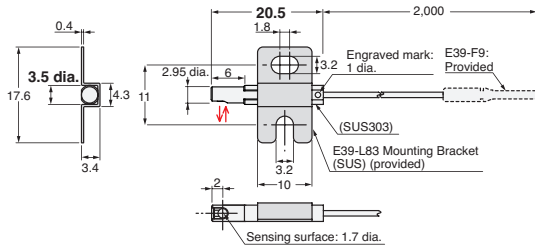

Note: Use the engraved surface and its opposing surface as installation (reference) surfaces.

55-B E32-A03-1 2M (Free Cutting)

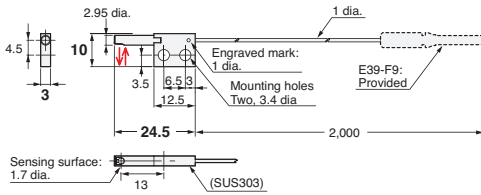

Note1: Use the engraved surface and its opposing surface as installation (reference) surfaces.
2. Set of two symmetrical parts.

55-C E32-A04 2M (Free Cutting)

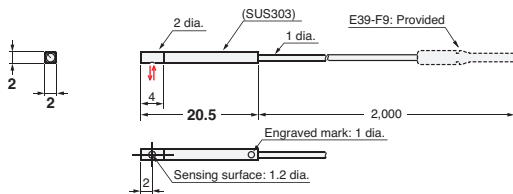

Note: Use the engraved surface and its opposing surface as installation (reference) surfaces.

55-D E32-T24SR 2M (Free Cutting)

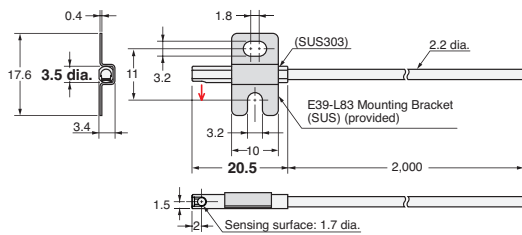

55-E E32-T24S 2M (Free Cutting)

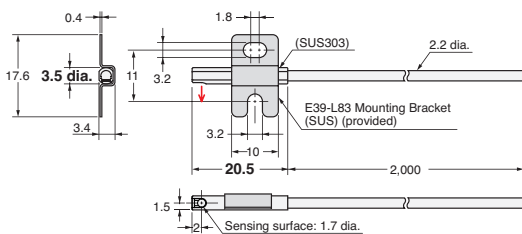

Fiber Sensor Features

Selection Guide

Fiber Units

Threaded

Cylindrical

Flat

Sleeved

Small Spot

High Power

Narrow view

BGS

Retro-reflective

Limited-reflective

Chemical-resistant, Oil-resistant

Bending

Heat-resistant

Area Detection

Liquid-level

Vacuum

FPD, Semi, Solar

Installation Information

Fiber Amplifiers, Communications Unit, and Accessories

Applications

Technical Guide and Precautions

Model Index

Models	Installation			Cable						Weight (packed state) (g)	Dimensions Page No.
	Ambient temperature	Tightening torque	Mounting hole	Bending radius	Unbendable length	Tensile strength	Sheath material	Core material	Emitter/receiver differentiation		
E32-A01 5M	-40 to 70°C	0.03N • m	–	R4	10	9.8N	Fluororesin	Plastic	None	200	49 Page (49-A)
E32-A03 2M	-40 to 70°C	0.29N • m	–	R1	0	9.8N	Polyethylene	Plastic	None	40	29 Page (29-A) 55 Page (55-A)
E32-A03-1 2M	-40 to 70°C	0.29N • m	–	R10	10	9.8N	Polyethylene	Plastic	None	50	29 Page (29-B) 55 Page (55-B)
E32-A04 2M	-40 to 70°C	0.29N • m	2.2 ^{+0.5} ₀ dia.	R10	10	9.8N	Polyethylene	Plastic	None	40	29 Page (29-C) 55 Page (55-C)
E32-A08 2M	-40 to 70°C *1	0.53N • m	–	R25	10	9.8N	Polyethylene	Plastic	None	60	35 Page (35-C) 53 Page (53-B)
E32-A08H2 3M	-40 to 300°C	0.53N • m	–	R25	10	29.4N	SUS	Glass	None	240	45 Page (45-D) 53 Page (53-C)
E32-A09 2M	-40 to 70°C *1, *2	0.53N • m	–	R25	10	9.8N	Polyethylene	Plastic	None	60	35 Page (35-F) 53 Page (53-E)
E32-A09H2 2M	-40 to 300°C	0.53N • m	–	R25	10	9.8N	SUS	Glass	None	230	45 Page (45-E) 53 Page (53-F)
E32-A12 2M	-40 to 70°C	0.53N • m	–	R25	10	9.8N	Polyethylene	Plastic	None	60	35 Page (35-D) 53 Page (53-D)
E32-C11N 2M	-40 to 70°C	0.98N • m	6.2 ^{+0.5} ₀ dia.	R4	0	29.4N	PVC and Polyethylene	Plastic	White line on emitter cable	70	09 Page (09-B)
E32-C31 2M	-40 to 70°C	0.78N • m	3.2 ^{+0.5} ₀ dia.	R25	10	9.8N	Polyethylene	Plastic	White line on emitter cable	40	09 Page (09-D)
E32-C31M 1M	-40 to 70°C	0.78N • m	3.2 ^{+0.5} ₀ dia.	R10	10	9.8N	Polyethylene	Plastic	White line on emitter cable	40	09 Page (09-E)
E32-C31N 2M	-40 to 70°C	0.29N • m	3.2 ^{+0.5} ₀ dia.	R4	0	9.8N	PVC and Polyethylene	Plastic	White line on emitter cable	40	09 Page (09-A)
E32-C41 1M	-40 to 70°C	0.78N • m	3.2 ^{+0.5} ₀ dia.	R25	10	9.8N	Polyethylene	Plastic	White tube on emitter cable	30	21 Page (21-A), (21-D)
E32-C42 1M	-40 to 70°C	0.29N • m	2.2 ^{+0.5} ₀ dia.	R25	10	9.8N	Polyethylene	Plastic	White tube on emitter cable	30	19 Page (19-A), (19-B)
E32-C42S 1M	-40 to 70°C	0.29N • m	3.2 ^{+0.5} ₀ dia.	R25	10	4N	Polyolefin	Plastic	White tube on emitter cable	30	19 Page (19-E)
E32-CC200 2M	-40 to 70°C	0.98N • m	6.2 ^{+0.5} ₀ dia.	R25	10	29.4N	Polyethylene	Plastic	White line on emitter cable	40	09 Page (09-H)
E32-D11 2M	-40 to 70°C	0.98N • m	6.2 ^{+0.5} ₀ dia.	R4	10	29.4N	PVC	Plastic	None	50	41 Page (41-E)
E32-D11R 2M	-40 to 70°C	0.98N • m	6.2 ^{+0.5} ₀ dia.	R1	0	29.4N	PVC	Plastic	None	50	09 Page (09-G)
E32-D11U 2M	-40 to 70°C	0.98N • m	6.2 ^{+0.5} ₀ dia.	R4	10	29.4N	Fluororesin	Plastic	None	60	37 Page (37-I)
E32-D12F 2M	-40 to 70°C	0.78N • m	6.5 ^{+0.5} ₀ dia.	R40	10	29.4N	Fluororesin	Plastic	None	190	37 Page (37-H)
E32-D15XR 2M	-40 to 70°C	0.15N • m	–	R1	0	29.4N	PVC	Plastic	None	60	15 Page (15-D)
E32-D15YR 2M	-40 to 70°C	0.15N • m	–	R1	0	29.4N	PVC	Plastic	None	60	15 Page (15-E)
E32-D15ZR 2M	-40 to 70°C	0.15N • m	–	R1	0	29.4N	PVC	Plastic	None	60	15 Page (15-F)
E32-D16 2M	-40 to 70°C	0.53N • m	–	R4	10	29.4N	PVC	Plastic	None	70	23 Page (23-C)
E32-D21 2M	-40 to 70°C	0.78N • m	3.2 ^{+0.5} ₀ dia.	R4	10	9.8N	PVC	Plastic	None	20	41 Page (41-B)
E32-D211R 2M	-40 to 70°C	0.78N • m	4.2 ^{+0.5} ₀ dia.	R1	0	9.8N	Polyethylene	Plastic	None	40	09 Page (09-F)
E32-D21B 2M	-40 to 70°C	0.78N • m	4.2 ^{+0.5} ₀ dia.	R4	10	9.8N	PVC	Plastic	None	40	41 Page (41-D)
E32-D21R 2M	-40 to 70°C	0.78N • m	3.2 ^{+0.5} ₀ dia.	R1	0	9.8N	Polyethylene	Plastic	None	20	09 Page (09-C)

*1 The heat-resistant rating is not the same for all parts of the Fiber Unit. Refer to the dimensions diagrams for details.

*2 Avoid rapid temperature changes.

Models	Installation			Cable						Weight (packed state) (g)	Dimensions Page No.
	Ambient temperature	Tightening torque	Mounting hole	Bending radius	Unbendable length	Tensile strength	Sheath material	Core material	Emitter/receiver differentiation		
E32-D221B 2M	-40 to 70°C	0.29N • m	3.2 ^{+0.5} / ₀ dia.	R4	10	9.8N	PVC	Plastic	None	40	13 Page (13-D) 41 Page (41-C)
E32-D22B 2M	-40 to 70°C	0.2N • m	1.7 ^{+0.5} / ₀ dia.	R4	10	9.8N	PVC	Plastic	None	30	13 Page (13-A) 41 Page (41-A)
E32-D22R 2M	-40 to 70°C	0.29N • m	3.2 ^{+0.5} / ₀ dia.	R1	0	9.8N	Polyethylene	Plastic	None	40	13 Page (13-C)
E32-D24R 2M	-40 to 70°C	0.29N • m	3.2 ^{+0.5} / ₀ dia.	R1	0	9.8N	Polyethylene	Plastic	None	40	17 Page (17-E)
E32-D25XB 2M	-40 to 70°C	0.15N • m	–	R4	10	9.8N	PVC	Plastic	None	40	41 Page (41-F)
E32-D32L 2M	-40 to 70°C	0.29N • m	3.2 ^{+0.5} / ₀ dia.	R25	10	29.4N	Polyethylene	Plastic	Yellow dotted line on emitter cable	50	13 Page (13-E)
E32-D33 2M	-40 to 70°C	0.29N • m	3.2 ^{+0.5} / ₀ dia.	R4	10	9.8N	Polyethylene	Plastic	None	40	13 Page (13-F) 17 Page (17-H)
E32-D331 2M	-40 to 70°C	0.29N • m	2.2 ^{+0.5} / ₀ dia.	R4	10	9.8N	Polyethylene	Plastic	None	30	17 Page (17-G)
E32-D36P1 2M	-40 to 70°C	0.78N • m	–	R4	10	29.4N	Polyethylene	Plastic	None	60	47 Page (47-D)
E32-D36T 5M	-40 to 70°C	–	–	R4	10	29.4N	Polyethylene	Plastic	None	190	49 Page (49-C)
E32-D43M 1M	-40 to 70°C	0.29N • m	1.7 ^{+0.5} / ₀ dia.	R4	10	9.8N	Polyethylene	Plastic	None	30	13 Page (13-B) 17 Page (17-F)
E32-D51 2M	-40 to 150°C ^{*1}	0.98N • m	6.2 ^{+0.5} / ₀ dia.	R35	10	29.4N	Fluoresin	Plastic	None	60	45 Page (45-B)
E32-D51R 2M	-40 to 100°C ^{*2}	0.98N • m	6.2 ^{+0.5} / ₀ dia.	R2	0	29.4N	Polyurethane	Plastic	None	60	45 Page (45-A)
E32-D61-S 2M	-60 to 350°C ^{*3}	0.98N • m	6.2 ^{+0.5} / ₀ dia.	R25	10	29.4N	SUS	Glass	None	190	45 Page (45-G)
E32-D611-S 2M	-60 to 350°C ^{*3}	0.98N • m	4.2 ^{+0.5} / ₀ dia.	R25	10	29.4N	SUS	Glass	None	170	45 Page (45-F)
E32-D73-S 2M	-40 to 400°C ^{*3}	0.78N • m	4.2 ^{+0.5} / ₀ dia.	R25	10	29.4N	SUS	Glass	None	170	45 Page (45-H)
E32-D81R-S 2M	-40 to 200°C ^{*3}	0.78N • m	6.2 ^{+0.5} / ₀ dia.	R10	10	9.8N	Fluoresin	Glass	None	70	45 Page (45-C)
E32-D82F1 4M	-40 to 200°C	0.29N • m	6.5 ^{+0.5} / ₀ dia.	R25	10	29.4N	Fluoresin	Plastic	None	450	49 Page (49-D)
E32-DC200BR 2M	-40 to 70°C	0.98N • m	6.2 ^{+0.5} / ₀ dia.	R1	0	29.4N	PVC	Plastic	None	60	17 Page (17-J)
E32-DC200F4R 2M	-40 to 70°C	0.78N • m	3.2 ^{+0.5} / ₀ dia.	R1	0	9.8N	Polyethylene	Plastic	None	40	17 Page (17-I)
E32-L11FP 5M	-10 to 60°C	0.78N • m	–	R40	10	9.8N	Fluoresin	Plastic	None	310	37 Page (37-F) 53 Page (53-G)
E32-L11FS 5M	-10 to 85°C	0.78N • m	–	R40	10	9.8N	Fluoresin	Plastic	None	310	37 Page (37-G) 53 Page (53-H)
E32-L15 2M	-40 to 70°C	0.53N • m	–	R25	10	29.4N	Polyethylene	Plastic	White tube on emitter cable	60	19 Page (19-F)
E32-L16-N 2M	-40 to 70°C	0.29N • m	–	R25	10	29.4N	Polyethylene	Plastic	None	60	31 Page (31-A) 35 Page (35-B) 53 Page (53-A)
E32-L24S 2M	-40 to 70°C	0.29N • m	–	R10	10	9.8N	Polyethylene	Plastic	None	40	31 Page (31-B) 35 Page (35-A)
E32-L25L 2M	-40 to 105°C ^{*2}	0.29N • m	–	R10	10	9.8N	Polyethylene	Plastic	None	40	31 Page (31-C) 35 Page (35-E)
E32-L25T 2M	-40 to 70°C	–	–	R10	10	9.8N	Polyethylene	Plastic	None	40	49 Page (49-B)

*1 For continuous operation, use the Fiber Unit between -40 to 130°C.

*2 For continuous operation, use the Fiber Unit between -40 to 90°C.

*3 The heat-resistant rating is not the same for all parts of the Fiber Unit. Refer to the dimensions diagrams for details.

- Fiber Sensor Features
- Selection Guide
- Fiber Units
- Standard Installation
 - Threaded
 - Cylindrical
- Saving Space
 - Flat
 - Sleeved
- Beam Improvements
 - Small Spot
 - High Power
 - Narrow view
 - BGS
- Transparent Objects
 - Retro-reflective
 - Limited-reflective
- Environmental Immunity
 - Chemical-resistant, Oil-resistant
 - Bending
 - Heat-resistant
- Applications
 - Area Detection
 - Liquid-level
 - Vacuum
 - FPD, Semi, Solar
- Installation Information
- Fiber Amplifiers, Communications Unit, and Accessories
- Technical Guide and Precautions
- Model Index

Models	Installation			Cable						Weight (packed state) (g)	Dimensions Page No.
	Ambient temperature	Tightening torque	Mounting hole	Bending radius	Unbendable length	Tensile strength	Sheath material	Core material	Emitter/receiver differentiation		
E32-R16 5M	-25 to 55°C	0.54N • m	–	R25	10	29.4N	Polyethylene	Plastic	None	220 (E39-R1 included.)	33 Page (33-B)
E32-R21 2M	-40 to 70°C	0.39N • m	6.2 ^{+0.5} ₀ dia.	R10	10	9.8N	Polyethylene	Plastic	None	70 (E39-R3 included.)	33 Page (33-C)
E32-T10V 2M	-25 to 70°C	0.3N • m	–	R25	10	29.4N	Fluororesin	Plastic	None	170	51 Page (51-D)
E32-T11 2M	-40 to 70°C	0.78N • m	4.2 ^{+0.5} ₀ dia.	R4	10	29.4N	PVC	Plastic	None	40	39 Page (39-C)
E32-T11F 2M	-40 to 70°C	0.29N • m	–	R4	10	29.4N	Fluororesin	Plastic	None	60	37 Page (37-C)
E32-T11N 2M	-40 to 70°C	0.78N • m	4.2 ^{+0.5} ₀ dia.	R1	0	29.4N	PVC	Plastic	None	70	07 Page (07-A)
E32-T11NF 2M	-25 to 70°C	12N • m	8.5 ^{+0.5} ₀ dia.	R1	0	29.4N	Fluororesin	Plastic	None	80	37 Page (37-A)
E32-T11R 2M	-40 to 70°C	0.78N • m	4.2 ^{+0.5} ₀ dia.	R1	0	29.4N	PVC	Plastic	None	50	07 Page (07-B)
E32-T12F 2M	-40 to 70°C	0.78N • m	5.5 ^{+0.5} ₀ dia.	R40	10	29.4N	Fluororesin	Plastic	None	210	37 Page (37-B)
E32-T12R 2M	-40 to 70°C	0.29N • m	3.2 ^{+0.5} ₀ dia.	R1	0	29.4N	PVC	Plastic	None	60	11 Page (11-C)
E32-T14 2M	-40 to 70°C	0.49N • m	–	R25	10	29.4N	Polyethylene	Plastic	None	60	23 Page (23-B)
E32-T14F 2M	-40 to 70°C	0.78N • m	5.5 ^{+0.5} ₀ dia.	R40	10	29.4N	Fluororesin	Plastic	None	220	37 Page (37-D)
E32-T14LR 2M	-40 to 70°C	0.29N • m	3.2 ^{+0.5} ₀ dia.	R1	0	29.4N	PVC	Plastic	None	60	11 Page (11-D)
E32-T15XR 2M	-40 to 70°C	0.15N • m	–	R1	0	29.4N	PVC	Plastic	None	60	15 Page (15-A)
E32-T15YR 2M	-40 to 70°C	0.15N • m	–	R1	0	29.4N	PVC	Plastic	None	60	15 Page (15-B)
E32-T15ZR 2M	-40 to 70°C	0.15N • m	–	R1	0	29.4N	PVC	Plastic	None	60	15 Page (15-C)
E32-T16JR 2M	-40 to 70°C	0.29N • m	–	R1	0	29.4N	PVC	Plastic	None	60	47 Page (47-B)
E32-T16PR 2M	-40 to 70°C	0.29N • m	–	R1	0	29.4N	PVC	Plastic	None	60	47 Page (47-A)
E32-T16WR 2M	-25 to 55°C	0.29N • m	–	R1	0	9.8N	PVC	Plastic	None	60	47 Page (47-C)
E32-T17L 10M	-40 to 70°C	0.78N • m	14.5 ⁺¹ ₀ dia.	R25	10	29.4N	Polyethylene	Plastic	None	240	23 Page (23-A)
E32-T21 2M	-40 to 70°C	0.78N • m	3.2 ^{+0.5} ₀ dia.	R4	10	9.8N	PVC	Plastic	None	30	39 Page (39-B)
E32-T223R 2M	-40 to 70°C	0.20N • m	1.2 ^{+0.5} ₀ dia.	R1	10	9.8N	Polyethylene	Plastic	None	40	11 Page (11-A)
E32-T22B 2M	-40 to 70°C	0.20N • m	1.7 ^{+0.5} ₀ dia.	R4	10	9.8N	PVC	Plastic	None	40	11 Page (11-B) 39 Page (39-A)
E32-T22S 2M	-40 to 70°C	0.29N • m	3.2 ^{+0.5} ₀ dia.	R10	10	29.4N	PVC	Plastic	None	60	29 Page (29-F)
E32-T24E 2M	-40 to 70°C	0.29N • m	2.7 ^{+0.5} ₀ dia.	R10	10	9.8N	Polyethylene	Plastic	None	40	17 Page (17-B)
E32-T24R 2M	-40 to 70°C	0.29N • m	2.2 ^{+0.5} ₀ dia.	R1	0	9.8N	Polyethylene	Plastic	None	40	17 Page (17-A)
E32-T24S 2M	-40 to 70°C	0.29N • m	–	R10	10	29.4N	PVC	Plastic	None	60	29 Page (29-E) 55 Page (55-E)
E32-T24SR 2M	-40 to 70°C	0.29N • m	–	R1	0	9.8N	PVC	Plastic	None	60	29 Page (29-D) 55 Page (55-D)
E32-T25XB 2M	-40 to 70°C	0.15N • m	–	R4	10	9.8N	PVC	Plastic	None	40	39 Page (39-D)
E32-T33 1M	-40 to 70°C	0.29N • m	3.2 ^{+0.5} ₀ dia.	R10	10	9.8N	Polyethylene	Plastic	None	40	17 Page (17-C)
E32-T51 2M	-40 to 150°C *1	0.78N • m	4.2 ^{+0.5} ₀ dia.	R35	10	29.4N	Fluororesin	Plastic	None	70	43 Page (43-B)
E32-T51F 2M	-40 to 150°C *1	0.78N • m	5.5 ^{+0.5} ₀ dia.	R40	10	29.4N	Fluororesin	Plastic	None	220	37 Page (37-E)
E32-T51R 2M	-40 to 100°C *2	0.78N • m	4.2 ^{+0.5} ₀ dia.	R2	0	29.4N	Polyurethane	Plastic	None	60	43 Page (43-A)
E32-T51V 1M	-25 to 120°C	0.29N • m	4.2 ^{+0.5} ₀ dia.	R30	10	29.4N	Fluororesin	Glass	None	160	51 Page (51-A)

*1 For continuous operation, use the Fiber Unit between -40 to 130°C.
 *2 For continuous operation, use the Fiber Unit between -40 to 90°C.

Models	Installation			Cable						Weight (packed state) (g)	Dimensions Page No.
	Ambient temperature	Tightening torque	Mounting hole	Bending radius	Unbendable length	Tensile strength	Sheath material	Core material	Emitter/receiver differentiation		
E32-T61-S 2M	-60 to 350°C ^{*1}	0.78N • m	4.2 ^{+0.5} / ₀ dia.	R25	10	29.4N	SUS	Glass	None	200	43 Page (43-D)
E32-T81R-S 2M	-40 to 200°C ^{*1}	0.78N • m	4.2 ^{+0.5} / ₀ dia.	R10	10	9.8N	Fluororesin	Glass	None	60	43 Page (43-C)
E32-T84SV 1M	-25 to 200°C	0.29N • m	4.5 ^{+0.5} / ₀ dia.	R25	10	29.4N	SUS	Glass	None	190	51 Page (51-C)
E32-TC200BR 2M	-40 to 70°C	0.78N • m	4.2 ^{+0.5} / ₀ dia.	R1	0	29.4N	PVC	Plastic	None	60	17 Page (17-D)
E32-VF1	-25 to 70°C	-	-	-	-	-	-	-	-	240	51 Page (51-F)
E32-VF4	-25 to 70°C	-	-	-	-	-	-	-	-	280	51 Page (51-E)
E39-F1	-40 to 200°C	-	-	-	-	-	-	-	-	2	24 Page (24-A) 25 Page (25-A) to (25-C) 26 Page (26-A) 27 Page (27-A) to (27-C)
E39-F1-33	-40 to 200°C	-	-	-	-	-	-	-	-	3	26 Page (26-D) 27 Page (27-J)
E39-F11	-	-	-	-	-	-	-	-	-	30	-
E39-F16	-60 to 350°C	-	-	-	-	-	-	-	-	15	24 Page (24-B) 25 Page (25-D) to (25-F) 26 Page (26-B) 27 Page (27-D) to (27-F), (27-K)
E39-F17	-25 to 70°C	-	-	-	-	-	-	-	-	10	19 Page (19-B)
E39-F18	-40 to 70°C	-	-	-	-	-	-	-	-	5	21 Page (21-G), (21-H)
E39-F1V	-25 to 120°C	-	-	-	-	-	-	-	-	3	51 Page (51-B)
E39-F2	-40 to 200°C	-	-	-	-	-	-	-	-	2	24 Page (24-C) 25 Page (25-G) to (25-H) 26 Page (26-C) 27 Page (27-G) to (27-I)
E39-F32A	-40 to 150°C	-	-	R30	-	-	-	-	-	70	41 Page (41-G)
E39-F32C	-40 to 150°C	-	-	R30	-	-	-	-	-	110	39 Page (39-E) 41 Page (41-G)
E39-F32D	-40 to 150°C	-	-	R30	-	-	-	-	-	80	41 Page (41-G)
E39-F3A	-40 to 70°C	-	-	-	-	-	-	-	-	2	19 Page (19-A)
E39-F3A-5	-40 to 70°C	-	-	-	-	-	-	-	-	1	21 Page (21-A), (21-B), (21-C)
E39-F3B	-40 to 70°C	-	-	-	-	-	-	-	-	2	21 Page (21-D), (21-E), (21-F)
E39-F3C	-40 to 70°C	-	-	-	-	-	-	-	-	1	19 Page (19-C), (19-D)
E39-F3R	-40 to 70°C	-	-	-	-	-	-	-	-	1	33 Page (33-A)
E39-R1	-25 to 55°C	-	-	-	-	-	-	-	-	20	33 Page (33-B)
E39-R3	-40 to 70°C	-	-	-	-	-	-	-	-	20	33 Page (33-C)
E39-RP37	-25 to 55°C	-	-	-	-	-	-	-	-	4	33 Page (33-A)

*1 The heat-resistant rating is not the same for all parts of the Fiber Unit. Refer to the dimensions diagrams for details.

Threaded	Standard Installation
Cylindrical	
Flat	Saving Space
Sleeved	
Small Spot	Beam Improvements
High Power	
Narrow view	
BGS	Transparent Objects
Retro-reflective	
Limited-reflective	
Chemical-resistant, Oil-resistant	Environmental Immunity
Bending	
Heat-resistant	
Area Detection	Applications
Liquid-level	
Vacuum	
FPD, Semi, Solar	

Threaded
Cylindrical

Flat
Sleeved

Small Spot
High Power
Narrow view

Retro-reflective
Limited-reflective

Chemical-resistant, Oil-resistant
Bending
Heat-resistant

Area Detection
Liquid-level
Vacuum
FPD, Semi, Solar

Smart Fiber Amplifier Units (Advanced Models)

E3X-HD

Access the advanced functions with the tip of your finger.
Fiber Amplifier Units for long-term, stable detections

- Advanced functions are easily accessible through user-friendly design.
- Detects light intensity reduction caused by dirt, vibration, or aging LED performance, and automatically compensates the light intensity and incident level. Long-term stable detection with no maintenance.

64 Page



Intuitive Operation and Visibility

Universal Design

Operation

Button symbols make operation easy to learn regardless of operator skill level and language barriers.

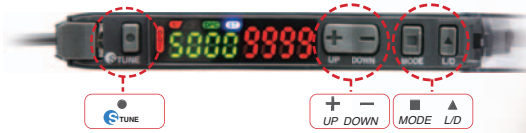

User-friendly buttons with error prevention functions.



Buttons are arranged in a straight line.

Pleasing operation even with gloves on.

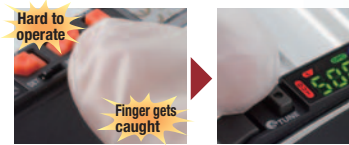

Conventional Models

Sliding switches

E3X-HD

Pushbutton switches (no sliding switches)

Smart Tuning

Smart tuning for the optimum settings with just one button.

Arc Design

A strong accent line gives a compact look to improve equipment design.

Indicators

Enhanced visibility with new digital display and instructional indicators.

New Concept: Visible indicators

- L D** Operation mode indicators to prevent incorrect settings.
- DPC** Flashing indicator enables preventive maintenance.
- ST** Indicates that the optimum settings have been made.



Long-term stable detection with No Maintenance.

Smart Power Control

Maintenance-free operation by double compensation of light intensity and incident level.

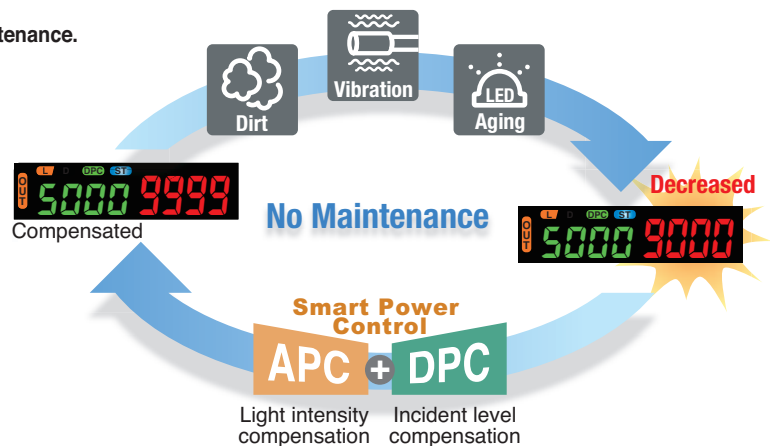

Communications Units

E3X-CRT/E3X-ECT * Compatible with E3X-HD0

Communications Units for CompoNet and EtherCAT

- No wiring is required to join Fiber Amplifier Units together.
- Setting change and read-out are easy.
- Many Fiber Amplifier Units can be connected.
(E3X-CRT: 16 Amplifiers, E3X-ECT: 30 Amplifiers)



70
Page

Simple Fiber Amplifier Units (Simple Models)

E3X-SD

Simple and Affordable Fiber Amplifier Units with Minimum Required Settings Menu

- The settings menu contains only the settings that are absolutely necessary for using the Fiber Sensor, and each setting is assigned to its own button.
- A single digital display eliminates reading the wrong value.
- Quick tuning to automatically set the incident level and threshold with a single button.



72
Page

No more menus for confusing advanced settings

Easy-to-use simple functions

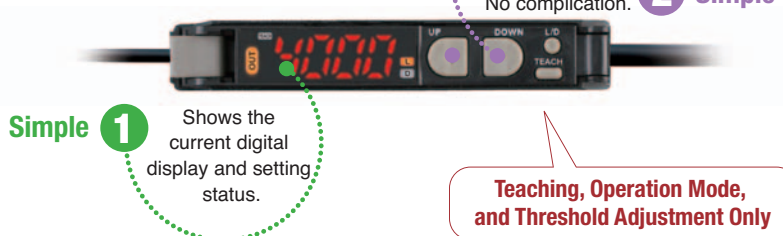

E3X-HD/E3X-SD

Featuring the Unparalleled Power of GIGA RAY

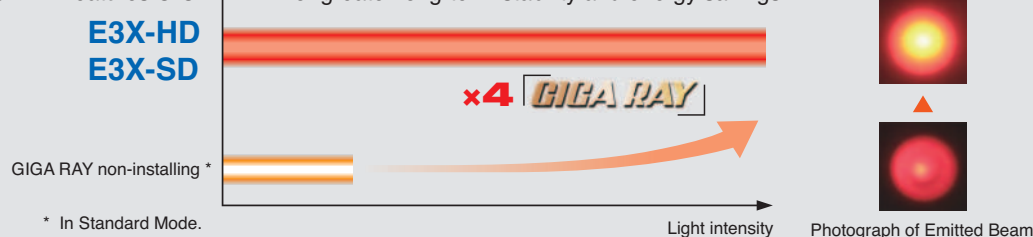

- These Fiber Amplifier Units use GIGA RAY power lighting elements, which offer the highest level of power in this class and allow the use of Reflective Fiber Units for reliable detection of low-reflective workpieces and long-distance detection in large-scale equipment.
- The E3X-HD features GIGA RAY II for greater long-term stability and energy savings.



Fiber Sensor Features	
Selection Guide	
Fiber Units	
Threaded	Standard Installation
Cylindrical	
Flat	Saving Space
Sleeved	
Small Spot	Beam Improvements
High Power	
Narrow view	Transparent Objects
BGS	
Retro-reflective	Environmental Immunity
Limited-reflective	
Chemical-resistant, Oil-resistant	Applications
Bending	
Heat-resistant	Installation Information
Area Detection	
Liquid-level	Fiber Amplifiers, Communications Unit, and Accessories
Vacuum	
FPD, Semi, Solar	Technical Guide and Precautions
	Model Index

Smart Fiber Amplifier Units (Advanced Models) E3X-HD Series



Fiber Amplifier Units (Standard)

Appearance	Connection method	Model		Ratings and Specifications	Dimensions
		NPN output	PNP output		
	Pre-wired (2 m)	E3X-HD11 2M	E3X-HD41 2M	Page 64	Page 64 (64-A)
	Wire-saving connector	E3X-HD6	E3X-HD8		Page 65 (65-A)



Fiber Amplifier Unit (For CompoNet/EtherCAT Communications Unit)

Appearance	Model	Ratings and Specifications	Dimensions
	E3X-HD0	Page 64	Page 65 (65-B)

Communications Units

Communication method	Appearance	Applicable Fiber Amplifier Model	Model	Ratings and Specifications	Dimensions
CompoNet		E3X-HD0 E3X-MDA0 E3X-DA0-S	E3X-CRT	Page 70	Page 71 (71-A)
EtherCAT			E3X-ECT		Page 71 (71-B)

Simple Fiber Amplifier Units (Simple Models) E3X-SD Series



Appearance	Connection method	Model		Ratings and Specifications	Dimensions
		NPN output	PNP output		
	Pre-wired (2 m)	E3X-SD21 2M	E3X-SD51 2M	Page 72	Page 73 (73-A)
	Wire-saving connector	E3X-SD7	E3X-SD9		Page 73 (73-B)

Threaded
CylindricalFlat
SleevedSmall Spot
High Power
Narrow
view
BGSRetro-
reflective
Limited-
reflectiveChemical-
resistant,
Oil-resistant
Bending
Heat-
resistantArea
Detection
Liquid-level
Vacuum
FPD,
Semi,
Solar

Accessories (sold separately)

Wire-saving connectors (Required for wire-saving connector models.)

Connectors are not provided with the Fiber Amplifier Unit and must be ordered separately. * Protective stickers: provided.

Type	Appearance	Cable length	Number of conductors	Model	Ratings and Specifications	Dimensions
Master Connector		2 m	3	E3X-CN11	Page 76	Page 76 76-A
Slave Connector			1	E3X-CN12		Page 76 76-B

Mounting Bracket

Mounting Bracket is not provided with the Fiber Amplifier Unit and must be ordered separately as required.

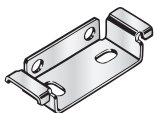
Appearance	Model	Quantity	Dimensions
	E39-L143	1	Page 77 77-A

DIN Track

Din Track is not provided with the Fiber Amplifier Unit and must be ordered separately as required.

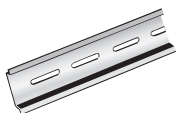
Appearance	Model	Quantity	Dimensions
	PFP-100N	1	Page 77 77-B
	PFP-50N		Page 77 77-C
	PFP-100N2		

End Plate

Two End Plates are provided with the Communications Unit.

End Plate is not provided with the Fiber Amplifier Unit and must be ordered separately as required.

Appearance	Model	Quantity	Dimensions
	PFP-M	1	Page 77 77-D

Fiber Sensor Features

Selection Guide

Fiber Units

Threaded	Standard Installation
Cylindrical	
Flat	Saving Space
Sleeved	
Small Spot	Beam Improvements
High Power	
Narrow view	
BGS	Transparent Objects
Retro-reflective	
Limited-reflective	
Chemical-resistant, Oil-resistant	Environmental Immunity
Bending	
Heat-resistant	
Area Detection	Applications
Liquid-level	
Vacuum	
FPD, Semi, Solar	Installation Information

Fiber Amplifiers, Communications Unit, and Accessories

Technical Guide and Precautions

Model Index

Ratings and Specifications

Item	Type	Standard				For Communications Unit *1
	Model	E3X-HD11	E3X-HD41	E3X-HD6	E3X-HD8	E3X-HD0
	Connection method	Pre-wired		Wire-saving connector *2		Communications Unit Connector
Control output	NPN output	PNP output	NPN output	PNP output	-	
Light source (wavelength)	Red, 4-element LED (625 nm)					
Power supply voltage	12 to 24 VDC ±10%, ripple (P-P) 10% max.					
Power consumption	Normal Mode: 720 mW max. (Current consumption: 30 mA max. at 24 VDC, 60 mA max. at 12 VDC) Power Saving Eco Mode: 530 mW max. (Current consumption: 22 mA max. at 24 VDC, 44 mA max. at 12 VDC)					
Control output	Load power supply voltage: 26.4 VDC max., open-collector output (Differs for NPN and PNP outputs.) Load current: 50 mA max. (residual voltage: 2 V max.), OFF current: 0.5 mA max.					-
Protection circuits	Power supply reverse polarity protection, output short-circuit protection and output reverse polarity protection					
Response time	Super-high-speed Mode (SHS) *3	Operate or reset: 50 μs	Operate or reset: 55 μs	Operate or reset: 50 μs	Operate or reset: 55 μs	Operate or reset: 50 μs
	High-speed Mode (HS)	Operate or reset: 250 μs (default setting)				
	Standard Mode (Std)	Operate or reset: 1 ms				
	Giga-power Mode (GIGA)	Operate or reset: 16 ms				
Mutual interference prevention	Possible for up to 10 units (optical communications sync) *3					
Auto power control (APC)	Always ON					
Other functions	Power tuning, differential detection, DPC, timer (OFF-delay, ON-delay, or one-shot), zero reset, resetting settings, and Eco Mode					
Ambient Illumination (Receiver side)	Incandescent lamp: 20,000 lx max., Sunlight: 30,000 lx max.					
Maximum connectable Units	16 units					with E3X-CRT: 16 units with E3X-ECT: 30 units
Ambient temperature range	Operating: Groups of 1 to 2 Amplifiers: -25 to 55°C, Groups of 3 to 10 Amplifiers: -25 to 50°C, Groups of 11 to 16 Amplifiers: -25 to 45°C Storage: -30 to 70°C (with no icing or condensation)					Operating: Groups of 1 to 2 Amplifiers: -25 to 55°C, Groups of 3 to 10 Amplifiers: -25 to 50°C, Groups of 11 to 16 Amplifiers: -25 to 45°C, Groups of 17 to 30 Amplifiers: -25 to 40°C Storage: -30 to 70°C (with no icing or condensation)
	Ambient humidity range					
Insulation resistance	Operating and storage: 35% to 85% (with no condensation)					
Dielectric strength	20 MΩ min. (at 500 VDC)					
Vibration resistance	1,000 VAC at 50/60 Hz for 1 minute					
Shock resistance	Destruction: 10 to 55 Hz with a 1.5-mm double amplitude for 2 hours each in X, Y, and Z directions					
Degree of protection	Destruction: 500 m/s ² , for 3 times each in X, Y, and Z directions					
Weight (packed state/unit only)	Approx. 105 g/Approx. 65 g		Approx. 60 g/Approx. 20 g		Approx. 65 g/Approx. 25 g	
Materials	Case	Heat-resistant ABS				Heat-resistant ABS (connector: PBT)
	Cover	Polycarbonate (PC)				
Accessories	Instruction Manual					

*1. The E3X-ECT EtherCAT Communications Unit and the E3X-CRT CompoNet Communications Unit can be used.
 *2. Use either the E3X-CN11 (master connector, 3 conductors) or the E3X-CN12 (slave connector, 1 conductor).
 *3. The communications function and mutual interference prevention function are disabled when the detection mode is set to Super-high-speed mode (SHS).
 When including E3X-DA-S with activated power tuning the maximum number of mutual interference prevention is up to 6.
 When including E3X-MDA with activated power tuning the maximum number of mutual interference prevention is up to 5.

Dimensions

(Unit: mm) Tolerance class IT16 applies to demmensions in this date sheet unless otherwise specified.

Pre-wired Models

64-A E3X-HD11
E3X-HD41

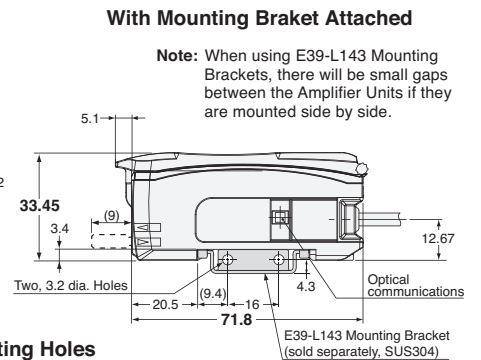
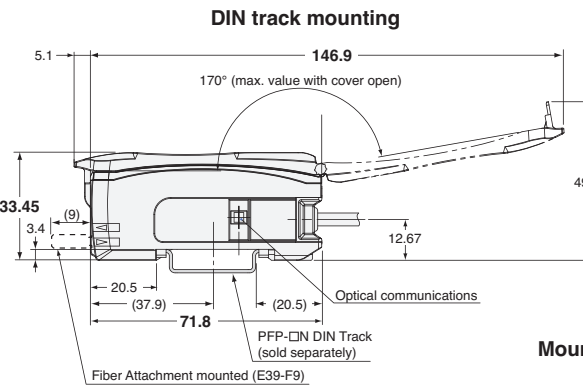
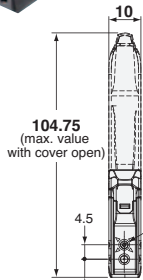
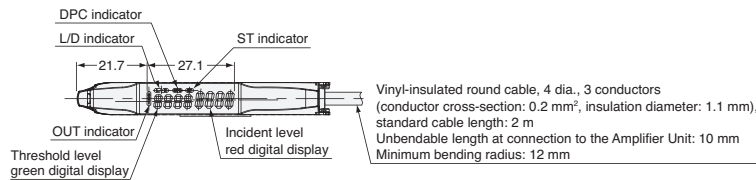

Mounting Holes

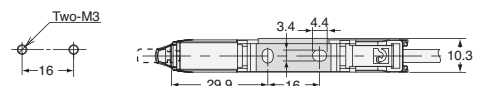

Fiber Sensor Features
 Selection Guide
 Fiber Units
 Standard Installation
 Threaded
 Cylindrical
 Saving Space
 Flat
 Sleeved
 Beam Improvements
 Small Spot
 High Power
 Narrow view
 BGS
 Transparent Objects
 Retro-reflective
 Limited-reflective
 Environmental Immunity
 Chemical-resistant, Oil-resistant
 Bending
 Heat-resistant
 Area Detection
 Liquid-level
 Vacuum
 FPD, Semi, Solar
 Installation Information
 Fiber Amplifiers, Communications Unit, and Accessories
 Technical Guide and Precautions
 Model Index

Wire-saving connector Models

65-A E3X-HD6
E3X-HD8

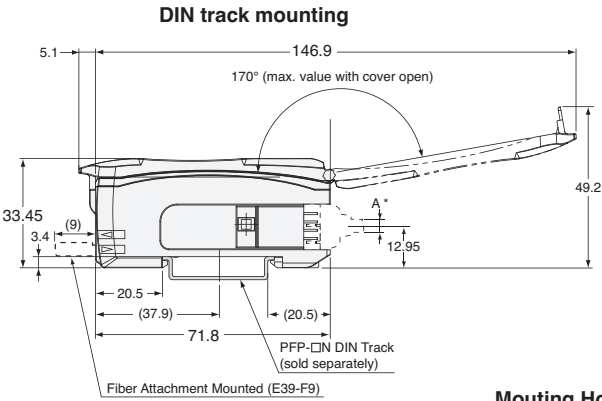
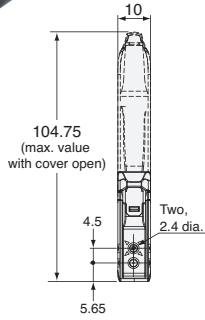
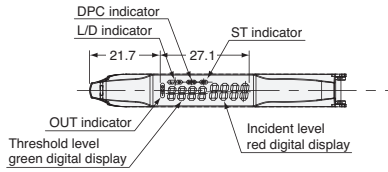

With Mounting Bracket Attached

Note: When using E39-L143 Mounting Brackets, there will be small gaps between the Amplifier Units if they are mounted side by side.

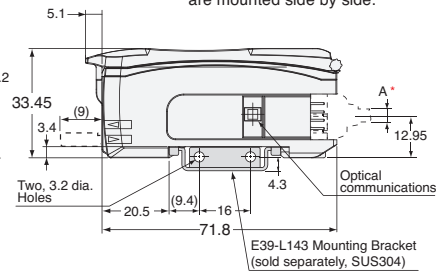

Mounting Holes

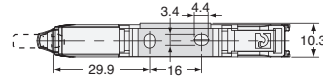

* The cable diameters are as follows:

E3X-CN11 (3 conductors)	4.0 dia.
E3X-CN21 (1 conductor)	2.6 dia.

Communications Unit Connector Models

65-B E3X-HD0

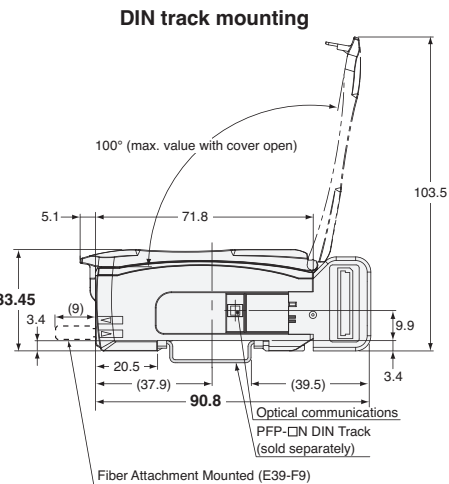
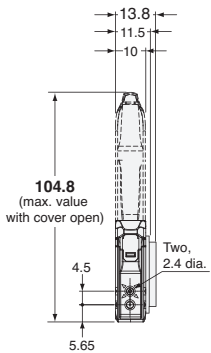
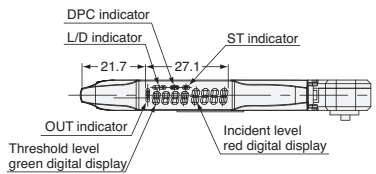

With Mounting Bracket Attached

Note: When using E39-L143 Mounting Brackets, there will be small gaps between the Amplifier Units if they are mounted side by side.

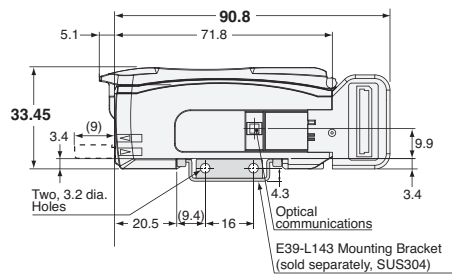

Mounting Holes

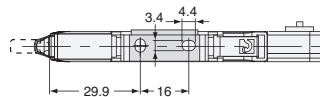

Fiber Sensor Features

Selection Guide

Fiber Units

Threaded

Cylindrical

Flat

Sleeved

Small Spot

High Power

Narrow view

BGS

Retro-reflective

Limited-reflective

Chemical-resistant, Oil-resistant

Bending

Heat-resistant

Area Detection

Liquid-level

Vacuum

FPD, Semi, Solar

Installation Information

Fiber Amplifiers, Communications Unit, and Accessories

Technical Guide and Precautions

Model Index

I/O Circuit Diagrams

NPN Output

Model	Operation mode	Timing chart	L/D indicators	Output circuit
E3X-HD11 E3X-HD6	Light-ON		L lit.	
	Dark-ON		D lit.	

PNP Output

Model	Operation mode	Timing chart	L/D indicators	Output circuit
E3X-HD41 E3X-HD8	Light-ON		L lit.	
	Dark-ON		D lit.	

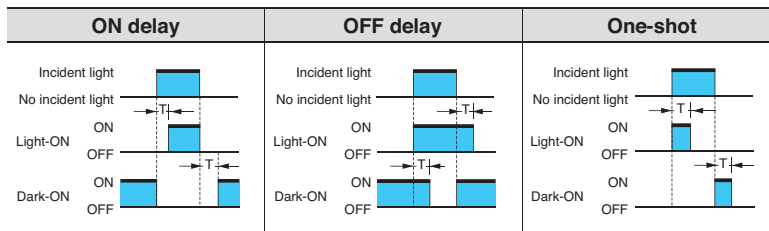

Note: Timing Charts for Timer Settings (T: Set Time)

Nomenclature

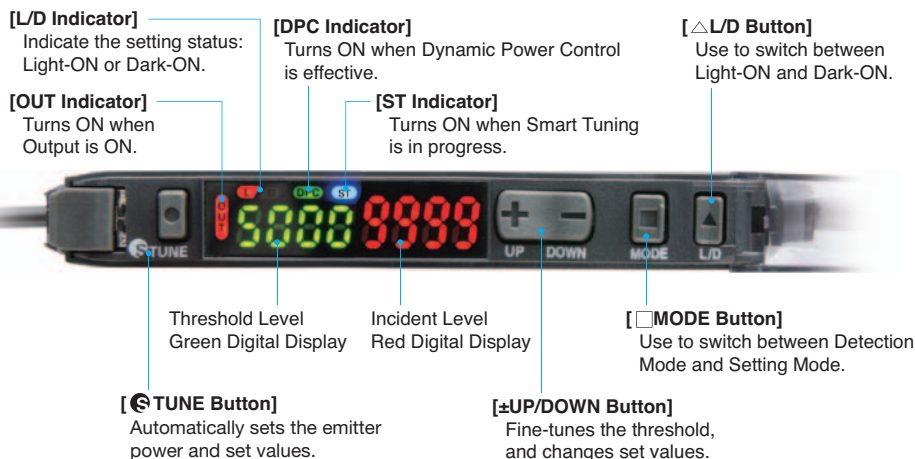

Fiber Sensor Features

Selection Guide

Fiber Units

Standard Installation

- Threaded
- Cylindrical

Saving Space

- Flat
- Sleeved

Beam Improvements

- Small Spot
- High Power
- Narrow view
- BGS

Transparent Objects

- Retro-reflective
- Limited-reflective

Environmental Immunity

- Chemical-resistant, Oil-resistant
- Bending
- Heat-resistant

Applications

- Area Detection
- Liquid-level
- Vacuum
- FPD, Semi, Solar

Installation Information

Fiber Amplifiers, Communications Unit, and Accessories

Technical Guide and Precautions

Model Index

Operating Procedures

Basic Settings

Switching Control Output

1. Press button.

Through-beam:

Set to "Dark ON" to turn the output ON with a workpiece in the detection area. [L/D Indicator] turns ON.

Reflective:

Set to "Light ON" to turn the output ON with a workpiece in the detection area. [L/D Indicator] turns ON.

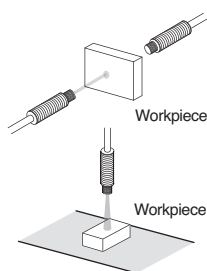

Smart Tuning [Easy Sensitivity Setting]

(1) Detect for Workpiece Presence/Absence

• 2-point Tuning

1. Press button with a workpiece in the detection area.

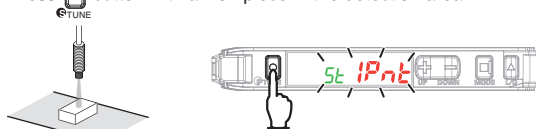

2. Press button again without a workpiece in the detection area.

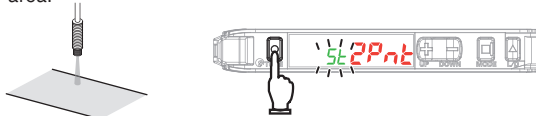

➔ Setting is Completed

Incident light level setting:

The larger incident level of the Step 1 and 2 values is adjusted to the power tuning level.

Threshold setting:

Set to the middle between the Step 1 and 2 incident light levels.



Step 1 and Step 2 can be reversed.

(2) Detect for Workpiece Presence/Absence

• Maximum Sensitivity Tuning

1. Hold button for 3 seconds or longer with/without workpiece as shown below.

Release the button when [FULL] is displayed.

Through-beam: Workpiece is present

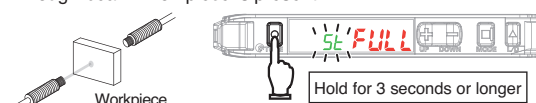

The red digital display changes [IPnt] → [FULL]

Reflective: Workpiece is absent

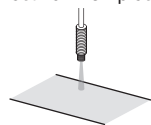

➔ Setting is Completed

Incident light level setting:

The incident level in Step 1 is adjusted to "0".

Threshold setting:

The value is set to approx. 7% of the incident light level of 1. If the incident light level of 1 is smaller during long distance detection, the minimum value by which an output is correctly turned ON will be set.

(3) Adjust for Moving Workpiece without Stopping Line

• Full Auto Tuning

1. Hold the button and pass the workpiece through while [IPnt] → [FULL] is displayed in red digital.

(Keep holding the button while the workpiece passes through, and hold 7 seconds or longer until [Auto] is displayed in red digital. After the workpiece passes through, release your finger from the button.)

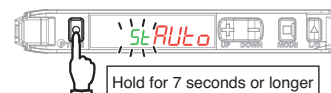
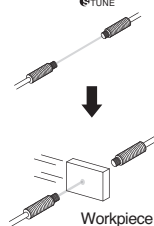

➔ Setting is Completed

Incident light level setting:

Adjust the max. incident light level on Step 1 as the power tuning level.

Threshold setting:

Set to the middle between max. and min. incident light levels on Step 1.

(4) Determine Workpiece Position

• Position Tuning

1. Press button without a workpiece in the area.

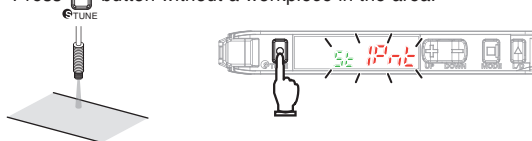

2. Place the workpiece at the desired position and hold button.

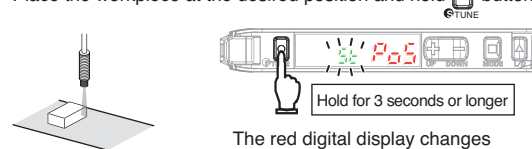

The red digital display changes [IPnt] → [Pos].

➔ Setting is Completed

Incident light level setting:

The Step 2 incident level is adjusted to half the power tuning level.

Threshold setting:

Set to the same value as the Step 2 incident level.

(5) Detect Transparent or Small Workpiece (Set Threshold by incident light level percentage)

• Percentage Tuning

1. Turn ON Percentage Tuning in SET mode.

Refer to "Detailed Settings".

2. Press button without a workpiece in the area.



➔ Setting is Completed

Incident light level setting:

The Step 2 incident light level is adjusted to the power tuning level.

Threshold setting:

Set to the value obtained by [Incident Level at Step 2 × Percentage Tuning Level + Incident Level at Step 2].



No Smart Tuning other than Power Tuning can be used if Percentage Tuning is set.

Threaded	Standard Installation
Cylindrical	
Flat	Saving Space
Sleeved	
Small Spot	Beam Improvements
High Power	
Narrow view	
BGS	Transparent Objects
Retro-reflective	
Limited-reflective	
Chemical-resistant, Oil-resistant	Environmental Immunity
Bending	
Heat-resistant	
Area Detection	Applications
Liquid-level	
Vacuum	
FPD, Semi, Solar	Installation Information

Threaded

Cylindrical

Flat

Sleeved

High Power

Narrow view

BGS

Retro-reflective

Limited-reflective

Chemical-resistant, Oil-resistant

Bending

Heat-resistant

Liquid-level

Vacuum

FPD, Semi, Solar

Smart Tuning Error

Error / Display / Cause	Error Origin Tuning Type	Remedy
<p>Near Error</p> <p>The light level difference between Points 1 and 2 are extremely small.</p>	2-point Tuning Full Auto Tuning Positioning Tuning	<ul style="list-style-type: none"> Change the detection function mode to a slower response time mode. Narrow the emitter and receiver distance (Through-beam) Mount the sensor closer to the workpiece (Reflective)
<p>Over Error</p> <p>Incident light level is too high.</p>	All	<ul style="list-style-type: none"> Enhance the power tuning level. Use a thin-diameter fiber. Widen the emitter and receiver distance (Through-beam) Distance the sensor from the workpiece (Reflective)
<p>Low Error</p> <p>Incident light level is too low.</p>	Tuning other than Maximum Sensitivity Tuning	<ul style="list-style-type: none"> Decrease the power tuning level. Narrow the emitter and receiver distance (Through-beam) Locate the sensor closer to the workpiece (Reflective)

CHECK! The adjustment range of smart tuning is approx. 20 to 1/100 times.
When selecting giga mode as detection function, the range will be approx. 2 to 1/100 times due to the large initial value.

Refer to "Detailed Settings" to change the power tuning level.

Minute Adjustment of Threshold Level

- Press UP/DOWN button to adjust the threshold level.

The threshold level becomes higher. The threshold level becomes lower.

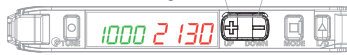

CHECK! Hold the key for high-speed level adjustment.

Convenient Setting Features

(1) Restore from the Incident Level Changed due to Dust and Dirt

Power Tuning

- Hold TUNE and MODE buttons for 1 second or longer without a workpiece in the area.

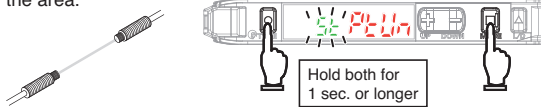

Setting is Completed

Incident light level setting:
The Step 1 incident level is adjusted to the power tuning level.
Threshold setting:
Not changed. If the value is low, it will be set to the minimum value in which an output is turned ON/OFF correctly.

CHECK! Perform the procedure with a workpiece in the area for reflective model setting.
If the setting is made after position tuning, set both the through-beam model and reflective model with a workpiece.

Refer to "Smart Tuning Error" for error displays.

(2) Stable Detection Regardless of Incident Level Change due to Dust and Dirt

DPC Function

- Perform Smart Tuning.

Refer to "Smart Tuning"
Refer to "Power Tuning"

The DPC indicator turns ON when the DPC function is effective.

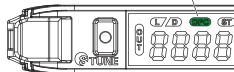

- Set the DPC function ON in SET mode.

Refer to "Detailed Settings".

CHECK!

- Steps 1 and 2 can be reversed.
- The DPC function will be disabled when a smart tuning error occurs, differential function with maximum sensitivity tuning is performed, or the first incident light level of the positioning tuning is low.
- The incident light level is corrected to the power tuning level to maintain stable threshold and incident light levels. This provides stable detection regardless of the incident level changes caused by dirty sensor head, position error, or temperature changes.

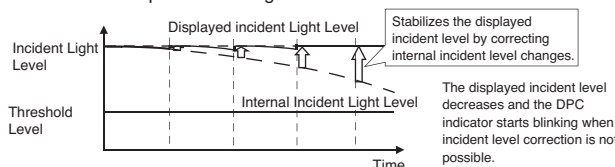

(3) Reset Settings

Setting Reset

Initializes all the settings by returning them to the factory defaults.

- Hold TUNE button and then hold LD button for 3 seconds or longer.

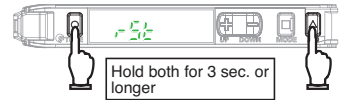

- Select [rSt] in UP/DOWN and press MODE button.

- Select [rSt] in UP/DOWN and press MODE button.

Item	Initial Value
Threshold Value	55
Control Output	L-ON

* Settings for other functions are returned to the detailed setting initial values.
User-saved settings are canceled.
Smart Tuning is canceled.

CHECK! Caution is required; the output is inverted if LD button is pressed first.

(4) Save or Read Settings

- Hold TUNE button and then hold LD button for 3 seconds or longer.

User Save Function

Saves the current settings.

- Select [SAVE] in UP/DOWN and press MODE button.

- Select [SAVE YES] in UP/DOWN and press MODE button.

User Reset Function

Reads out the saved settings.

- Select [rSt] in UP/DOWN and press MODE button.

- Select [rSt USER] in UP/DOWN and press MODE button.

CHECK! Caution is required; the output is inverted if LD button is pressed first.

(5) Prevent Mistake-operation

Key Lock Function

Disables all button operations. [Loc on] is displayed when the button is pressed.

Enable/Cancel (This procedure)

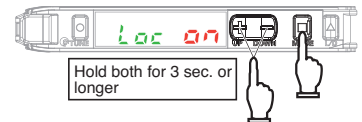

* Press either of UP/DOWN.

(6) Reset Incident Light Level to "0"

Zero Reset Function

Changes the incident light level to "0". The threshold level is also shifted accordingly.

Enable

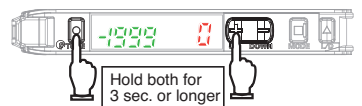

Cancel

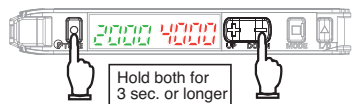

CHECK! The zero reset function is canceled when either of the DPC function/differential function/Smart Tuning is performed.

Detailed Settings

Hold button for 3 seconds or longer to enter SET mode.

SET mode provides the function settings described hereafter. The initial display shown after transition from one function to another represents the factory default.

Function Setting	Description																
1. Function Selection 	Changing Functions to Set in SET Mode [OFF]: Functions 1. to 5. can be set [ON]: Functions 1. to 10. can be set.																
2. Detection Function (Incident Light Level Example) (a) (b) (c) (d)	Changing Light Level and Response Time <table border="1"> <thead> <tr> <th>Detection Function</th> <th>Response Time</th> <th>Light Level</th> </tr> </thead> <tbody> <tr> <td>HS High-speed Mode</td> <td>250 μs</td> <td>1 (Standard)</td> </tr> <tr> <td>STND Standard Mode</td> <td>1 ms</td> <td>1 time</td> </tr> <tr> <td>GIGA Giga Mode</td> <td>16ms</td> <td>12 times</td> </tr> <tr> <td rowspan="2">SHS Super High-speed Mode*</td> <td>NPN 50 μs</td> <td rowspan="2">0.25 times</td> </tr> <tr> <td>PNP 55 μs</td> </tr> </tbody> </table> <p>Smart Tuning is canceled if the detection mode is changed. * The communication and mutual interference prevention functions are disabled when the detection mode is set to Super High-speed Mode.</p> <p> The incident light level in setting mode is a reference value. It may be changed when switched to detection mode. CHECK!</p>	Detection Function	Response Time	Light Level	HS High-speed Mode	250 μs	1 (Standard)	STND Standard Mode	1 ms	1 time	GIGA Giga Mode	16ms	12 times	SHS Super High-speed Mode*	NPN 50 μs	0.25 times	PNP 55 μs
Detection Function	Response Time	Light Level															
HS High-speed Mode	250 μs	1 (Standard)															
STND Standard Mode	1 ms	1 time															
GIGA Giga Mode	16ms	12 times															
SHS Super High-speed Mode*	NPN 50 μs	0.25 times															
	PNP 55 μs																
3. DPC Function 	Stable Detection Regardless of Incident Light Level Change Refer to "Convenient Setting Features"																
4. Timer Function 	Setting Output Timer <table border="1"> <thead> <tr> <th>Off-delay Timer</th> <th>On-delay Timer</th> <th>One-shot Timer</th> </tr> </thead> <tbody> <tr> <td> Holds the output ON for detection by PLC when the detection time is too short. </td> <td> Delays the output ON after detection. </td> <td> Keeps the output ON for a specified time regardless of the workpiece size variations. </td> </tr> </tbody> </table> <p>A timer value can be set after pressing button when a timer menu (other display than "----") is displayed. Use button to set the time. (1 to 9999 ms in 1 ms steps; the initial value: 10 ms)</p>	Off-delay Timer	On-delay Timer	One-shot Timer	 Holds the output ON for detection by PLC when the detection time is too short.	 Delays the output ON after detection.	 Keeps the output ON for a specified time regardless of the workpiece size variations.										
Off-delay Timer	On-delay Timer	One-shot Timer															
 Holds the output ON for detection by PLC when the detection time is too short.	 Delays the output ON after detection.	 Keeps the output ON for a specified time regardless of the workpiece size variations.															
5. Power Tuning Level 	Changing the Target Incident Light Level (Power Tuning Level) Use button to set the power tuning level. [000 to 9999] in 1 steps; the initial value: 9999 Refer to "Convenient Setting Features"																

Function Setting	Description												
6. Percentage Tuning 	Detecting Transparent or Small Workpiece Press button in [PER ON] menu, then use button to set the percentage tuning level. (-99% to 99% in 1% steps; the initial value: -10%) Refer to "Smart Tuning"												
7. Differential Function 	Detecting Incident Light Level Change Detects if the absolute value of the incident light level change of the set response time is larger than the threshold value. The display shows the change of the incident light level of the set response time in red. <table border="1"> <thead> <tr> <th>Differential Setting</th> <th>Response Time</th> </tr> </thead> <tbody> <tr> <td>1</td> <td>250 μs</td> </tr> <tr> <td>2</td> <td>500 μs</td> </tr> <tr> <td>3</td> <td>1ms</td> </tr> <tr> <td>4</td> <td>10 ms</td> </tr> <tr> <td>5</td> <td>100 ms</td> </tr> </tbody> </table> Use button to specify the response time. When the differential function is enabled, the detection function setting is disabled. Smart tunings except power tuning are disabled. The adjustment range of power tuning is approx. 1 to 1/100 times.	Differential Setting	Response Time	1	250 μs	2	500 μs	3	1ms	4	10 ms	5	100 ms
Differential Setting	Response Time												
1	250 μs												
2	500 μs												
3	1ms												
4	10 ms												
5	100 ms												
8. Digital Display 	Changing Digital Display in RUN Mode for Specific Purpose <p>Checking a Margin Against Threshold (a) The ratio of the incident light level to the threshold is displayed in red digital figures.</p> <p>Setting Threshold using a Small or Fast Moving Workpiece (b) Holds and displays the minimum value of the peak of the light incident and the maximum value of the bottom of the light interruption.</p> <p>Setting for Intuitive Analog Display (c) Displays the current level in the 80 to 120% range against the threshold value (100%).</p> <p>Adjusting Optical Axis (d) Holds the peak incident light level and displays it in green digital figures.</p> <p>Checking the Channel No. in Group Mounting (e) Checking the Channel No. in Group Mounting.</p>												
9. Inverted Display 	Mounting Amplifier in Inverted Direction Inverts the display upside down. The digital display shows the threshold value in red, and light incident level in green.												
10. Eco Function 	Saving Power Consumption Indicators (Green and Red digital displays) turn OFF in approx. 10 seconds after a key operation.												

Threaded	Standard Installation
Cylindrical	

Flat	Saving Space
Sleeved	

Small Spot	Beam Improvements
High Power	

Narrow view	Transparent Objects
BGS	

Retro-reflective	Environmental Immunity
Limited-reflective	

Chemical-resistant, Oil-resistant	Applications
Bending	

Heat-resistant	Applications
Area Detection	

Liquid-level	Applications
Vacuum	

FPD, Semi, Solar	Installation Information

Threaded

Cylindrical

Flat

Sleeved

Small Spot

High Power

Narrow
view

BGS

Retro-
reflectiveLimited-
reflectiveChemical-
resistant,
Oil-resistant

Bending

Heat-
resistantArea
Detection

Liquid-level

Vacuum

FPD,
Semi,
Solar

Ratings and Specifications

E3X-CRT

Item	Specifications
Communication method	CompoNet Communications
Connectable Sensors	Fiber Sensors: E3X-HD0, E3X-MDA0 and E3X-DA0-S Laser Sensor Head with Separate Digital Amplifier: E3C-LDA0 Proximity Sensor with Separate Amplifier: E2C-EDA0
Communications power supply voltage	14 to 26.4 VDC (Communications Unit draws power from the communications power supply.)
Power and current consumption	2.4 W max. (Not including power the supplied to Sensor.) 100 mA max. at 24 VDC (Not including the current supplied to Sensor.)
Functions	I/O communications, message communications, and Sensor error output
Indicators	MS Indicator (Green/Red), NS indicator (Green/Red), and SS (Sensor Status) indicator (Green/Red)
Vibration resistance	10 to 150 Hz with double amplitude of 0.7 mm, or 50 m/s ² 1.5 h each in X, Y, and Z directions
Shock resistance	150 m/s ² 3 times each in X, Y, and Z directions
Dielectric strength	500 VAC 50/60Hz 1 minute
Insulation resistance	20MΩ min.
Ambient operating temperature	0 to 55°C (with no icing or condensation) * The temperature is limited by the number of connected Fiber Amplifier Units.
Ambient operating humidity	25% to 85% (with no icing or condensation)
Storage temperature	-30 to 70°C (with no icing or condensation)
Storage humidity	25% to 85% (with no condensation)
Mounting method	35-mm DIN track-mounting
Weight (packed state/unit only)	Approx. 220 g/Approx. 95 g
Accessories	Connector cover and DIN track End Plates

Note. The E3X-CRT has two operating modes: I/O mode 1 and I/O mode 2.
The following table gives the differences between these modes.

	I/O classification	Number of allocated points	Maximum number of interconnected
I/O Mode 1	Input Unit	Input: 32	15
I/O Mode 2	I/O Unit	Input: 64 Output: 64	16

* Temperature Limitations Based on Number of Connected Fiber Amplifier Units:
Groups of 1 to 2 Amplifiers: 0 to 55°C,
Groups of 3 to 10 Amplifiers: 0 to 50°C,
Groups of 11 to 16 Amplifiers: 0 to 45°C

Read the User's Manual for precautions on using this Unit. (E412)

E3X-ECT

Item	Specifications
Communication method	EtherCAT
Connectable Sensors	Fiber Sensor E3X-HD0, E3X-MDA0 and E3X-DA0-S Laser Sensor Head with Separate Digital Amplifier: E3C-LDA0 Proximity Sensor with Separate Amplifier: E2C-EDA0
Power supply voltage	20.4 to 26.4 VDC
Power and current consumption	2.4 W max. (Not including power the supplied to Sensor.) 100 mA max. at 24 VDC (Not including the current supplied to Sensor.)
Functions	DC (synchronous) Mode, Free Run Mode, PDO communications,*1 SDO communications, Sensor error output
Indicators	L/A IN indicator (Yellow), L/A OUT indicator (Yellow), PWR indicator (Green), RUN indicator (Green), ERROR indicator (Red), and SS (Sensor Status) indicator (Green/Red)
Vibration resistance	10 to 150 Hz with double amplitude of 0.7 mm, or 50 m/s ² 1.5 h each in X, Y, and Z directions
Shock resistance	150 m/s ² 3 times each in X, Y, and Z directions
Insulation resistance	500 VAC 50/60 Hz 1 minute
Dielectric strength	20MΩ min.
Ambient operating temperature	0 to 55°C (with no icing or condensation) * The temperature is limited by the number of connected Fiber Amplifier Units.
Ambient operating humidity	25% to 85% (with no condensation)
Storage temperature	-30 to 70°C (with no icing or condensation)
Storage humidity	25% to 85% (with no condensation)
Mounting method	35-mm DIN track-mounting
Weight (packed state/unit only)	Approx. 220 g/Approx. 95 g
Accessories	Power supply connector, connector cover, and DIN track End Plates

- *1. Data Size Assignable to the PDO (Process Data Object):
There is a maximum data size that can be assigned. The maximum size is 36 bytes.
- *2. Temperature Limitations Based on Number of Connected Fiber Amplifier Units:
Groups of 1 to 2 Amplifiers: 0 to 55°C,
Groups of 3 to 10 Amplifiers: 0 to 50°C,
Groups of 11 to 16 Amplifiers: 0 to 45°C,
Groups of 17 to 30 Amplifiers: 0 to 40°C

Read the User's Manual for precautions on using this Unit. (E413)

Dimensions

(Unit: mm)
Tolerance class IT16 applies to demmensions in this date sheet unless otherwise specified.

71-A E3X-CRT

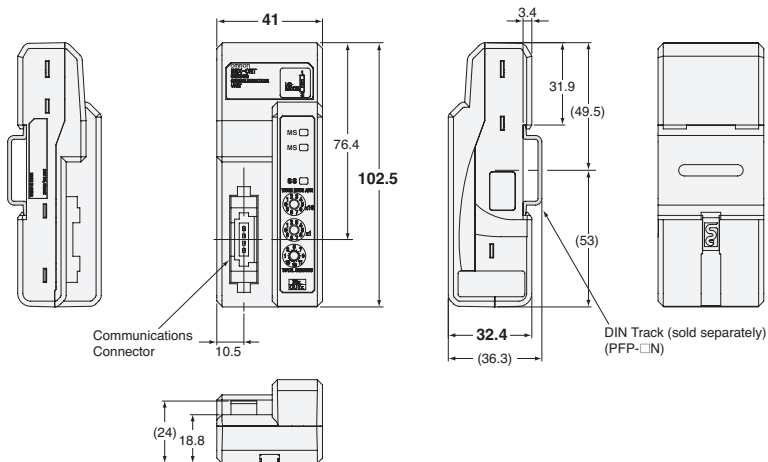

71-B E3X-ECT

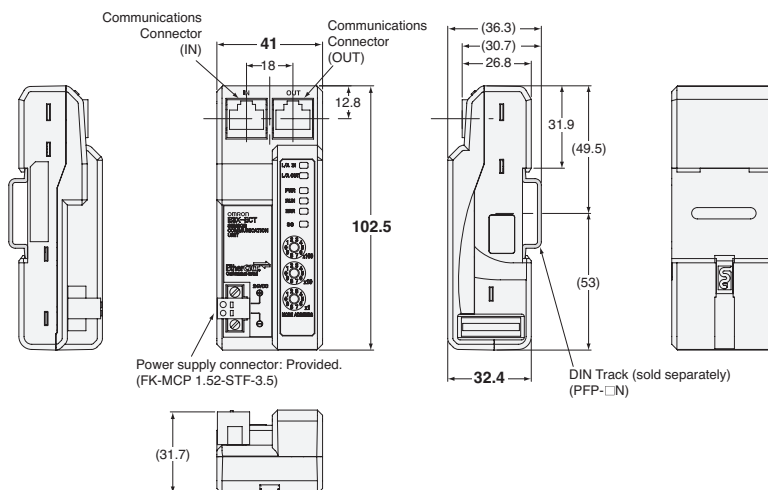

Fiber Sensor Features

Selection Guide

Fiber Units

Threaded	Standard Installation
Cylindrical	
Flat	Saving Space
Sleeved	
Small Spot	Beam Improvements
High Power	
Narrow view	
BGS	Transparent Objects
Retro-reflective	
Limited-reflective	
Chemical-resistant, Oil-resistant	Environmental Immunity
Bending	
Heat-resistant	
Area Detection	Applications
Liquid-level	
Vacuum	
FPD, Semi, Solar	

Installation Information

Fiber Amplifiers, Communications Unit, and Accessories

Technical Guide and Precautions

Model Index

Ratings and Specifications

Item	Model	E3X-SD21	E3X-SD51	E3X-SD7	E3X-SD9
	Connection method	Pre-wired		Wire-saving connector	
	Control output	NPN output	PNP output	NPN output	PNP output
Light source (wavelength)	Red, 4-element LED (625 nm)				
Power supply voltage	12 to 24 VDC \pm 10%, ripple (p-p): 10% max.				
Power consumption	960 mW max. (Power supply voltage: 24 V, Current consumption: 40 mA max.) (Power supply voltage: 12 V, Current consumption: 80 mA max.)				
Control output	Open-collector output (NPN or PNP) Load power supply: 26.4 V max., Load current: 50 mA max. (Residual voltage: 1.5 V max.) Light-ON/Dark-ON mode selector				
Response time	Operate or reset: 200 μ s max.				
Sensitivity adjustment	UP/DOWN direct key setting, teaching with/without a workpiece, automatic teaching				
Protection circuits	Power supply reverse polarity protection, output short-circuit protection, output reverse polarity protection				
Mutual interference prevention	Up to 5 Amplifiers (optically synchronized) *				
Ambient illumination	Receiver side Incandescent lamp: 10,000 lx max. Sunlight: 20,000 lx max.				
Number of gang-mounted Amplifiers	16 max. (The ambient temperature specification depends on the number of gang-mounted Amplifiers.)				
Ambient temperature range	Operating: Groups of 1 to 3 Amplifiers: -25°C to 55°C Groups of 4 to 11 Amplifiers: -25°C to 50°C Groups of 12 to 16 Amplifiers: -25°C to 45°C Storage: -30°C to 70°C (with no icing or condensation)				
Ambient humidity range	Operating and storage: 35% to 85% (with no condensation)				
Insulation resistance	20 M Ω . min. (at 500 VDC)				
Dielectric strength	1,000 VAC at 50/60 Hz for 1 minute				
Vibration resistance	Destruction: 10 to 55 Hz with a 1.5-mm double amplitude for 2 hours each in X, Y and Z directions				
Shock resistance	Destruction: 500 m/s ² , for 3 times each in X, Y and Z directions				
Degree of protection	IEC 60529 IP50 (with Protective Cover attached)				
Weight (packed state)	Approx. 100 g			Approx. 55 g	
Material	Case	Polybutylene terephthalate (PBT)			
	Cover	Polycarbonate (PC)			
Accessories	Instruction manual				

* Mutual interference prevention is effective when E3X-SD series or E3X-NA series Amplifiers are gang-mounted without other E3X series Amplifiers.

Threaded

Cylindrical

Flat

Sleeved

Small Spot

High Power

Narrow
view

BGS

Retro-
reflectiveLimited-
reflectiveChemical-
resistant,
Oil-resistant

Bending

Heat-
resistantArea
Detection

Liquid-level

Vacuum

FPD,
Semi,
Solar

Dimensions

(Unit: mm)
Tolerance class IT16 applies to demmensions in this date sheet unless otherwise specified.

Pre-wired Models

73-A E3X-SD21
E3X-SD51



Vinyl-insulated round cable, 4 dia., 3 conductors
(conductor cross-section: 0.2 mm², insulation diameter: 1.1 mm),
standard cable length: 2 m
Unbendable length at connection to the Amplifier Unit: 10 mm
Minimum bending radius: 12 mm

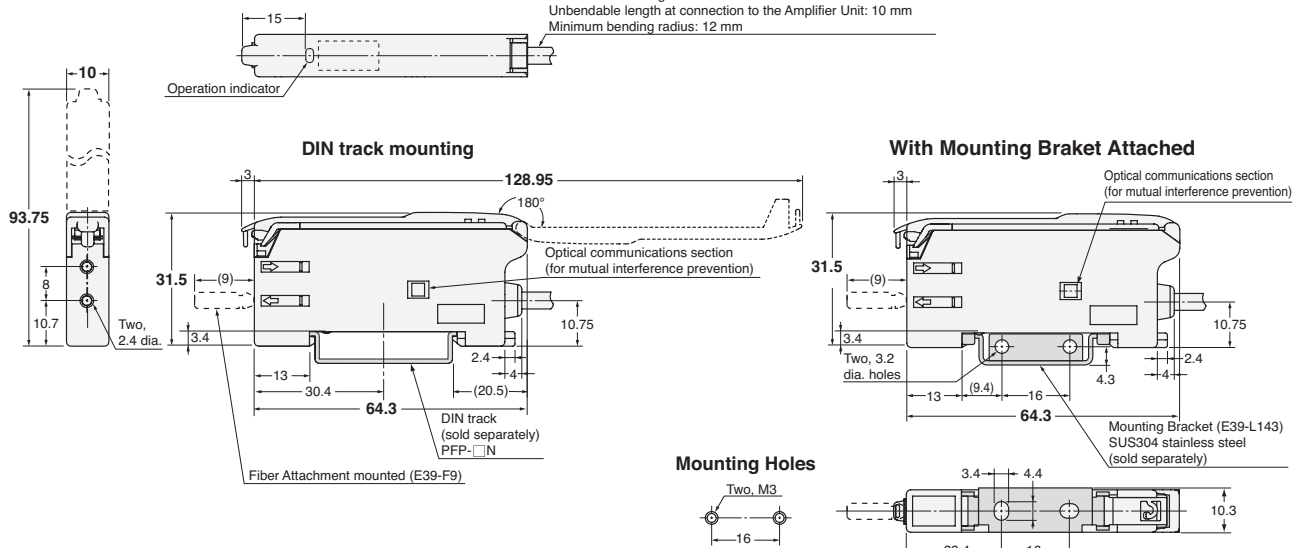

Note: When using E39-L143 Mounting Brackets, there will be small gaps between the Amplifier Units if they are mounted side by side.

Wire-saving connector Models

73-B E3X-SD7
E3X-SD9

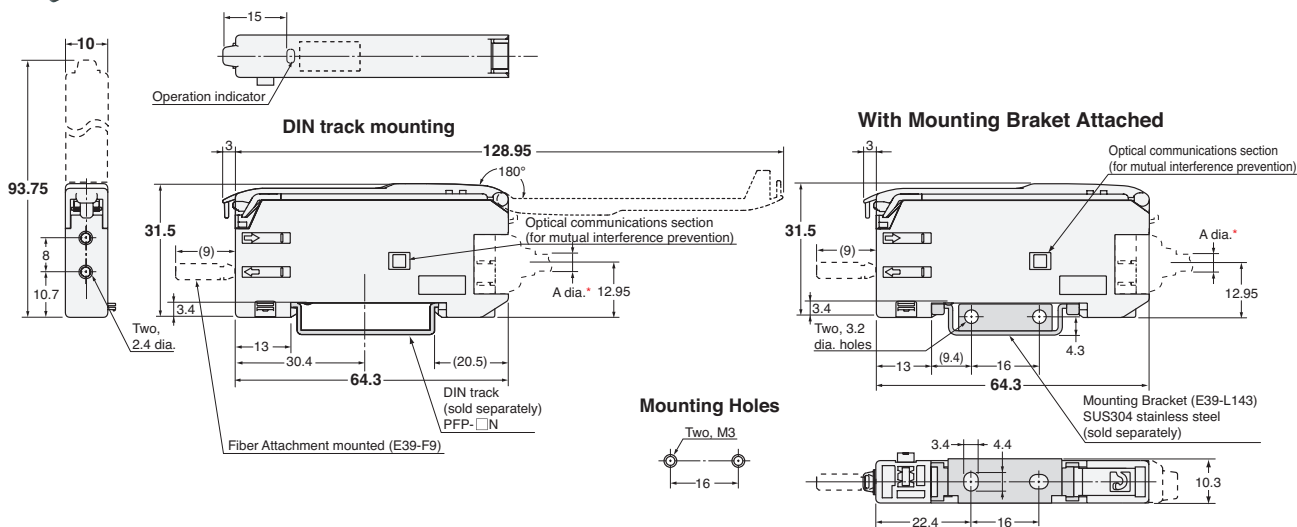

* Cable Diameters

E3X-CN11 (3 conductors)	4.0 dia.
E3X-CN12 (1 conductors)	2.6 dia.

Note: When using E39-L143 Mounting Brackets, there will be small gaps between the Amplifier Units if they are mounted side by side.

Fiber Sensor Features

Selection Guide

Fiber Units

Threaded	Standard Installation
Cylindrical	
Flat	Saving Space
Sleeved	
Small Spot	Beam Improvements
High Power	
Narrow view	Transparent Objects
BGS	
Retro-reflective	Environmental Immunity
Limited-reflective	
Chemical-resistant, Oil-resistant	Applications
Bending	
Heat-resistant	Installation Information
Area Detection	
Liquid-level	Fiber Amplifiers, Communications Unit, and Accessories
Vacuum	
FPD, Semi, Solar	Technical Guide and Precautions
	Model Index

I/O Circuit Diagrams

NPN Output

Model	Operation mode	Timing chart	L/D indicators	Output circuit
E3X-SD21 E3X-SD7	Light-ON	Incident light No incident light OUT indicator (orange) Lit Not lit Output transistor ON OFF Set Reset (between brown and black)	L lit.	
	Dark-ON	Incident light No incident light OUT indicator (orange) Lit Not lit Output transistor ON OFF Set Reset (between brown and black)	D lit.	

PNP Output

Model	Operation mode	Timing chart	L/D indicators	Output circuit
E3X-SD51 E3X-SD9	Light-ON	Incident light No incident light OUT indicator (orange) Lit Not lit Output transistor ON OFF Set Reset (between Blue and black)	L lit.	
	Dark-ON	Incident light No incident light OUT indicator (orange) Lit Not lit Output transistor ON OFF Set Reset (between Blue and black)	D lit.	

Fiber Sensor Features

Selection Guide

Fiber Units

Standard Installation

Threaded

Cylindrical

Saving Space

Flat

Sleeved

Beam Improvements

Small Spot

High Power

Narrow view

BGS

Transparent Objects

Retro-reflective

Limited-reflective

Environmental Immunity

Chemical-resistant, Oil-resistant

Bending

Heat-resistant

Applications

Area Detection

Liquid-level

Vacuum

FPD, Semi, Solar

Installation Information

Fiber Amplifiers, Communications Unit, and Accessories

Technical Guide and Precautions

Model Index

Nomenclature

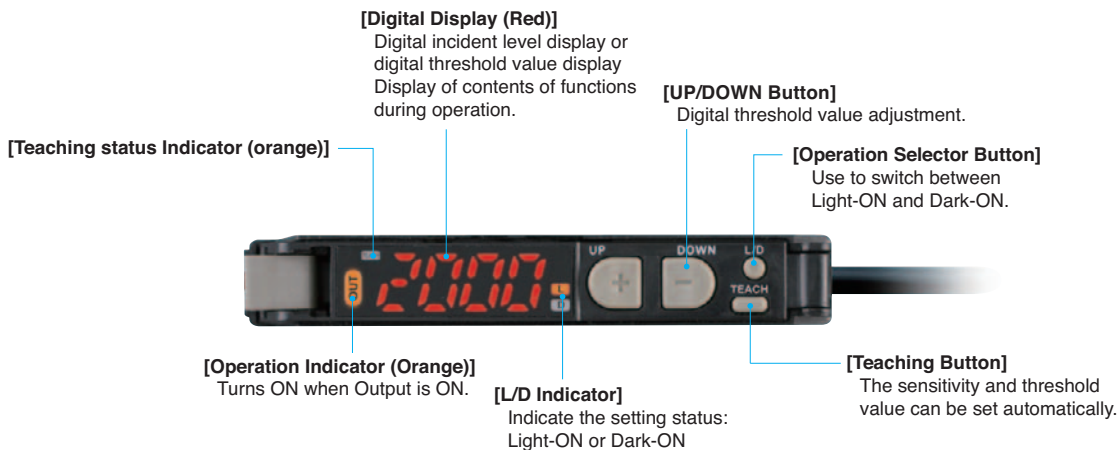

Operating Procedures

Sensitivity Setting

The sensitivity can be set with the UP and DOWN Keys similar to using an adjuster knob. The sensitivity can also be easily set by using the following two teaching functions.

Teaching with/without a Workpiece

Two points (one with the workpiece and the other without) are detected, and the operating level is set to the midpoint. Light level is also automatically set to the optimal value.

Operation description	Button/Key
Press the TEACH button with the workpiece.	TEACH
Press the TEACH button without the workpiece.	TEACH

Automatic Teaching

Changes within a time are detected, and the operating level is set to the midpoint between the maximum and the minimum values of the changes. This setting is optimal for when the workpieces cannot be stopped. Execute automatic teaching again if the incident light level is not automatically set to the optimal value.

Operation description	Button/Key
Press the TEACH button for 3 s min. Let the workpiece pass while the button is pressed.	TEACH

Fiber Sensor Features

Selection Guide

Fiber Units

Threaded	Standard Installation
Cylindrical	
Flat	Saving Space
Sleeved	
Small Spot	Beam Improvements
High Power	
Narrow view	
BGS	Transparent Objects
Retro-reflective	
Limited-reflective	
Chemical-resistant, Oil-resistant	Environmental Immunity
Bending	
Heat-resistant	
Area Detection	Applications
Liquid-level	
Vacuum	
FPD, Semi, Solar	

Installation Information

Fiber Amplifiers, Communications Unit, and Accessories

Technical Guide and Precautions

Model Index

Threaded

Cylindrical

Flat

Sleeved

Small Spot

High Power

Narrow view

BGS

Retro-reflective

Limited-reflective

Chemical-resistant, Oil-resistant

Bending

Heat-resistant

Area Detection

Liquid-level

Vacuum

FPD, Semi, Solar

Ratings and Specifications

Wire-saving Connectors

Item	Type	Master Connector	Slave Connector
	Model	E3X-CN11	E3X-CN12
Number of conductors		3	1
Diameter of cable		4 dia.	2.6 dia.
Rated current		2.5 A	
Rated voltage		50 VDC	
Contact resistance		20 mΩ max. (20 mVDC max., 100 mA max.) (The above figure is for connection to the Amplifier Unit and the adjacent Connector. It does not include the conductor resistance of the cable.)	
Number of insertions		Destruction: 50 times (for connection to the Amplifier Unit and the adjacent Connector)	
Material	Housing	Polybutylene terephthalate (PBT)	
	Contact	Phosphor bronze/gold-plated nickel	
Weight (packed state)		Approx. 55 g	Approx. 25 g

Dimensions

(Unit: mm)
Tolerance class IT16 applies to demmensions in this date sheet unless otherwise specified.

Wire-saving Connectors

Master Connector

76-A E3X-CN11

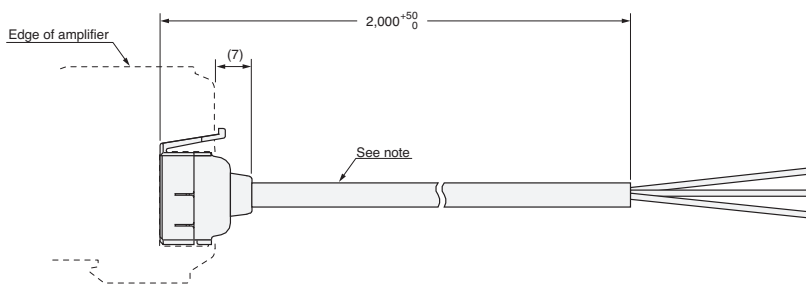

Note: 4 dia. cable / 3 conductors / Standard length: 2 m (Conductor cross section: 0.2 mm² (AWG24), Insulator diameter: 1.1 mm)

Slave Connector

76-B E3X-CN12

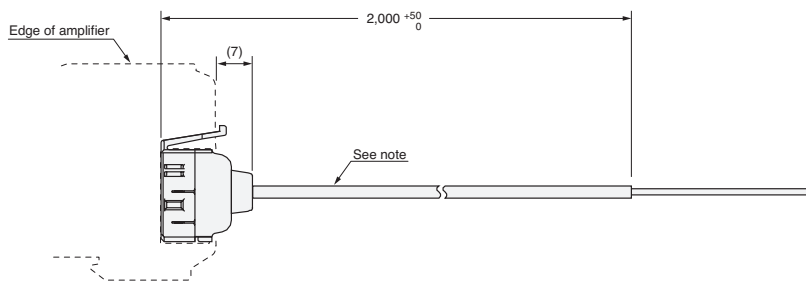

Note: 2.6 dia. cable / 1 conductor / Standard length: 2 m (Conductor cross section: 0.2 mm² (AWG24), Insulator diameter: 1.1 mm)

Mounting Brackets

77-A E39-L143

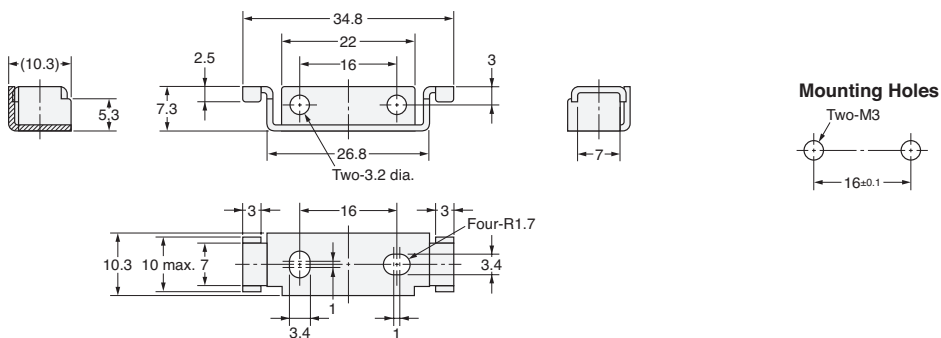
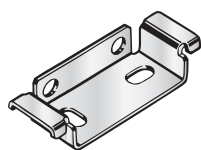

Material: Stainless steel (SUS304)

DIN track

77-B PFP-100N
PFP-50N

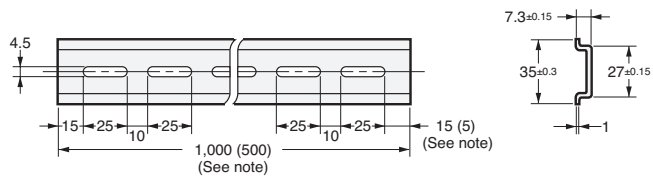

Material: Aluminum

Note: The figures in parentheses are for the PFP-50N.

77-C PFP-100N2

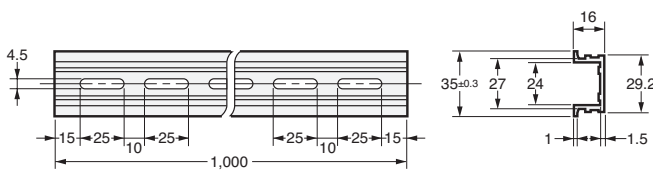

Material: Aluminum

End Plate

77-D PFP-M

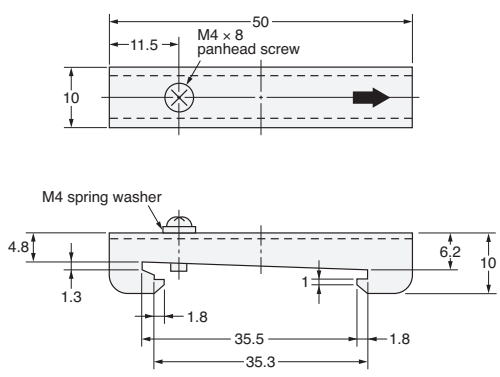

Material: Iron, galvanization

Fiber Sensor Features

Selection Guide

Fiber Units

Threaded	Standard Installation
Cylindrical	
Flat	Saving Space
Sleeved	
Small Spot	Beam Improvements
High Power	
Narrow view	
BGS	Transparent Objects
Retro-reflective	
Limited-reflective	
Chemical-resistant, Oil-resistant	Environmental Immunity
Bending	
Heat-resistant	
Area Detection	Applications
Liquid-level	
Vacuum	
FPD, Semi, Solar	Installation Information

Fiber Amplifiers, Communications Unit, and Accessories

Technical Guide and Precautions

Model Index

Reference Information for Fiber Units

Influence of Fiber Cable Length

The sensing distance listed in the Fiber Units specifications are based on the fiber cable lengths found in the suffix of the model number.

The sensing distance will change if the fiber cable is cut or extended.

The following graph shows the percentage change of the various fiber cable length, where 100% is the sensing distance for a fiber cable with a length of 2 m.

Use this as a guideline for installation distances.

Keep in mind that extending the cable with a fiber connector will result in even shorter sensing distances than the value given in the graph.

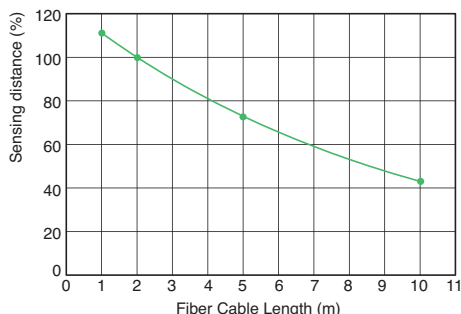

* The 100% value is for a fiber cable with a length of 2 m (same for Through-beam and Reflective Models).

Reflective Models: Sensing Distance Ratios by Workpiece Materials

The following graph shows the percentage change of the various workpieces, where 100% is the sensing distance for white paper, the standard sensing object.

Refer to the value of the material that looks like your workpiece.

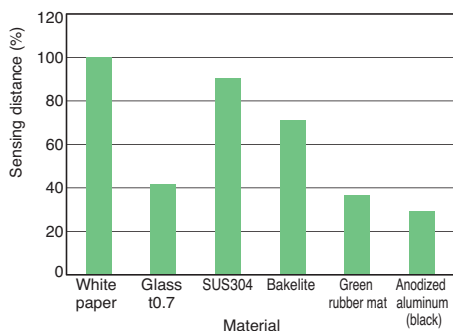

* White paper is 100%.

Types of Fiber Cables

This section describes the features of different types of fiber cables.

(This is given in the Fiber Unit specifications as either Flexible or Bend-resistant for the cable bending radius, and Coaxial for the appearance.)

If no definition is given, a standard cable is used.)

• Flexible Fibers

The flexible fiber has a small bending radius for easy routing without easily breaking.

It is easy to use because the cable can be bent without significantly reducing light intensity.

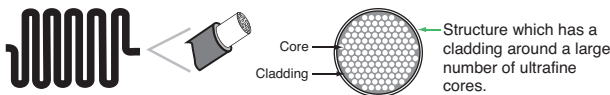

• Break-resistant Fibers

This fiber is resistant to repeated bends for use on moving parts.

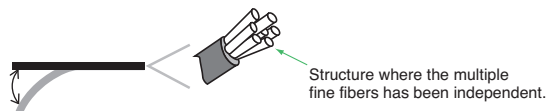

• Standard Fibers

This fiber have a large bending radius compared with bend-resistant or flexible fiber.

Use this fiber where the bending radius is large, or on non-moving parts.

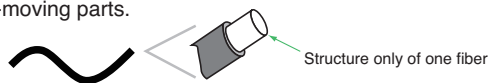

• Coaxial Reflective Fibers

These fibers are suitable for sensing small objects at close range.

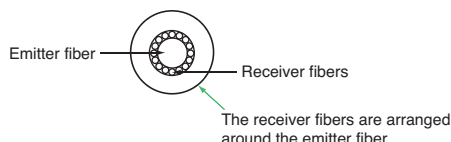

Fiber Sensor Features

Selection Guide

Fiber Units

Standard Installation
Threaded
Cylindrical

Saving Space
Flat
Sleeved

Beam Improvements
Small Spot
High Power
Narrow view
BGS

Transparent Objects
Retro-reflective
Limited-reflective

Environmental Immunity
Chemical-resistant, Oil-resistant
Bending
Heat-resistant

Applications
Area Detection
Liquid-level
Vacuum
FPD, Semi, Solar

Installation Information

Fiber Amplifiers, Communications Unit, and Accessories

Technical Guide and Precautions

Model Index

Q&A

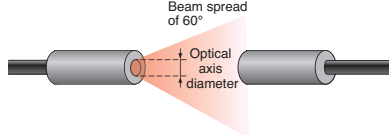
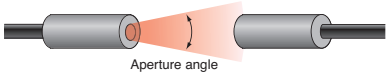
Category	Question	Answer
Fiber Units	How do I interpret the optical axis diameter in the Fiber Unit specifications?	<p>The optical axis diameter is the beam size that the Through-beam Fiber Unit uses for detection.</p> <p>If you are detecting objects larger than the optical axis diameter, you can expect stable detection performance because the object will block all of the beams of light that are used for detection.</p> <p>The incident level may fluctuate, however, if the workpiece passes the beam at high speed.</p> <p>In this case, it is best to select a Fiber Unit with a smaller optical axis diameter, or change the response time of the Fiber Amplifier Unit (E3X-HD Series) to High-speed mode or to Super-high-speed mode setting.</p> 
	Are there any differences between the Fiber Units that are used for emitter and receiver?	<p>With Through-beam Fiber Units, there is no difference between emitter fibers and receiver fibers.</p> <p>With Reflective Fiber Units, the emitter fibers and receiver fibers are different on Coaxial Reflective Models.</p> <p>Emitter fiber cables have identification marks. Refer to the individual dimensions diagrams for details.</p>
	What size must the hole be to mount a Threaded or Cylindrical Fiber Unit?	Refer to the recommended mounting hole dimensions given on pages 56 to 59.
	Are Fiber Cables available in different lengths?	Some models are available with either 5-m or 10-m cable. Ask your OMRON representative for details.
	What is the aperture angle?	<p>The aperture angle is the angle at which the emitter beam spreads out.</p> 
	Are these Fiber Units CE certified?	Fiber Units do not have any electrical components and therefore are exempt from CE certification.
	Can these Fiber Units be used in explosion-proof areas?	The Fiber Units can be used in an explosion-proof area. Install only the Fiber Unit in the explosion-proof area and install the Fiber Amplifier Unit outside the explosion-proof area.
	Fiber Amplifier Units	What is the difference between the E3X-HD Series and E3X-SD Series?
Can the Fiber Amplifier Units be connected with other models?		The E3X-HD Series can be connected only with the E3X-DA-S and MDA Series. The E3X-SD Series can be connected only with the E3X-NA Series.
Can the Fiber Amplifier Unit be operated from a mobile console?		Mobile consoles cannot be used with either the E3X-HD Series or the E3X-SD Series.
Can the Fiber Amplifier Unit be used with a Communications Unit?		If you use E3X-HD0 Amplifier Units, you can use either the E3X-CRT or E3X-ECT. The E3X-SD Series cannot be used with a Communications Unit.

Fiber Sensor Features

Selection Guide

Fiber Units

Threaded
Cylindrical
Standard Installation

Flat
Sleeved
Saving Space

Small Spot
High Power
Beam Improvements

Narrow view
BGS

Retro-reflective
Limited-reflective
Transparent Objects

Chemical-resistant, Oil-resistant
Bending
Environmental Immunity

Heat-resistant
Area Detection

Liquid-level
Vacuum
Applications

FPD, Semi, Solar
Installation Information

Fiber Amplifiers, Communications Unit, and Accessories

Technical Guide and Precautions

Model Index

Threaded

Cylindrical

Flat

Sleeved

Small Spot

High Power

Narrow
view

BGS

Retro-
reflectiveLimited-
reflectiveChemical-
resistant,
Oil-resistant

Bending

Heat-
resistantArea
Detection

Liquid-level

Vacuum

FPD,
Semi,
Solar

Fiber Amplifier Unit

Warning

This product is not designed or rated for ensuring safety of persons either directly or indirectly.
Do not use it for such purposes.

**Caution**

Do not use the product with voltage in excess of the rated voltage.
Excess voltage may result in malfunction or fire.



Never use the product with AC power supply.
Using an AC power supply may result in rupturing.

**Precautions for Safe Use**

The following precautions must be observed to ensure safe operation of the Sensor.

- (1) Do not use the Sensor in environments subject to flammable or explosive gases.
- (2) Do not use the Sensor in environments subject to exposure to water, oil, chemicals, etc.
- (3) Do not install the Sensor in environments subject to intense electric field or ferromagnetic field.
- (4) Do not attempt to disassemble, repair, or modify the Sensor Unit in any way.
- (5) Do not apply voltages or currents that exceed the rated ranges.
- (6) Do not use the Sensor in any atmosphere or environment that exceeds the ratings.
- (7) Do not miswire such as the polarity of the power supply.
- (8) Connect the load correctly.
- (9) Do not short both ends of the load.
- (10) Do not use the Sensor if the case is damaged.
- (11) When disposing of the Sensor, treat it as industrial waste.
- (12) High-Voltage lines and power lines must be wired separately from this Sensor. Wiring them together or placing them in the same duct may cause induction, resulting in malfunction or damage.
- (13) When setting the Sensor, be sure to check safety such as by stopping the equipment.

Precautions for Correct Use

- Do not install the Sensor in the following locations.
 - (1) Locations subject to direct sunlight
 - (2) Locations subject to condensation due to high humidity
 - (3) Locations subject to corrosive gas
 - (4) Locations subject to vibration or mechanical shocks exceeding the rated values
 - Use an extension cable with a minimum thickness of 0.3 mm² and less than 100 m long.
 - Do not apply the forces on the cord exceeding the following limits: Pull: 40 N; torque: 0.1 N·m; pressure: 20 N; bending: 3 kg
 - The Sensor is ready to operate 200 ms after the power supply is turned ON. If the Sensor and load are connected to power supplies separately, turn ON the power supply to the Sensor first.
 - When using the wire-saving connector type, attach the protective sticker (provided with E3X-CN series connectors) on the unused power pins to prevent electrical shock and short circuiting.
- When using the connector type for the communications unit, attach the protective cap.

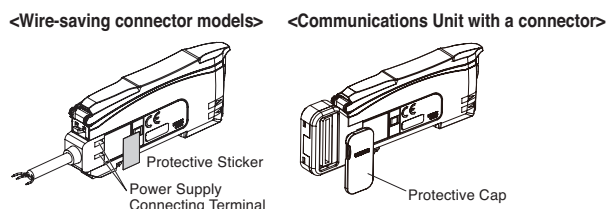

- Output pulses may occur when the power supply is turned OFF. Turn OFF the power supply to the load or load line first.
- Excessive incident light cannot be sufficiently handled by the mutual interference prevention function and may cause malfunction. To prevent this, set a higher threshold level.
- Make sure that the power supply is turned OFF before connecting, separating or adding Amplifier Units.
- Do not pull or apply excessive pressure or force (exceeding 9.8 N) on the Fiber Unit when it is mounted on the Amplifier Unit.
- The E3X-MC11, E3X-MC11-SV2 and E3X-MC11-S Mobile Consoles cannot be used.
- Mutual interference prevention on the E3X-HD Series does not function among the E3X-DA-N, E3X-SD, or E3X-NA Fiber Amplifier Units. Mutual interference prevention on the E3X-HD Series does function among the E3X-DA-S and E3X-MDA Fiber Amplifier Units. Mutual interference prevention works only when all of the Fiber Amplifier Units are from the E3X-SD Series or the E3X-NA Series.
- The E3X-HD0 can be used with E3X-CRT or E3X-ECT Communications Unit, but the E3X-DRT21-S cannot. The E3X-SD Series and the E3X-HD Standard Models (E3X-HD11, E3X-HD41, E3X-HD6, and E3X-HD8) cannot be used with either of the Communications Units.
- If the output short-circuit protection is activated by an overload or short circuit in a control output, **OVER** will flash on the display. Check the connection of the load.
- If a write error occurs due to noise caused by a power interruption or static electricity (**EEP Error** will flash on the display), use the setting keys on the Fiber Amplifier Unit to initialize it.
- Always keep the protective cover in place when using the Amplifier Unit.
- Do not use thinner, benzene, acetone, and lamp oil for cleaning.

Mounting the Fiber Amplifier Units

■ Mounting on DIN Track

1. Let the hook on the Amplifier Unit's Fiber Unit connection side catch the track and push the unit until it clicks.

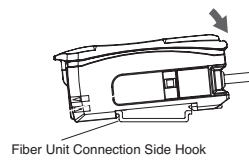

■ Removing from DIN Track

1. Push the unit in the direction 1.
2. Lift it up in the direction 2.

Refer to "I/O Circuit Diagrams" or check the side of the unit for wire color and role indications.

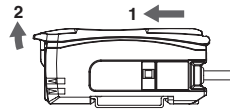

■ Mounting Amplifier Units in Group (Connector Type Models)

1. Mount the Fiber Amplifier units one at a time onto the DIN track and push them until they click. Use E3X-CN11 (Master connector) for the master Fiber Amplifier unit and E3X-CN12 (Slave connector) for the slave Fiber Amplifier units.
2. Slide the Fiber Amplifier units in the direction 2.
3. Use End Plates (PFP-M: separately sold) at the both ends of the grouped Fiber Amplifier units to prevent them from separating due to vibration or other cause.
4. Tighten the screw on the End Plates using a driver.

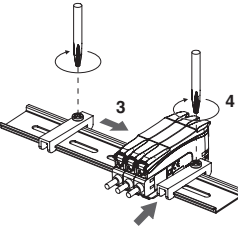
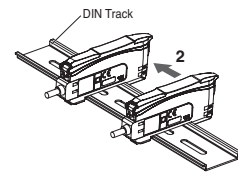

Tighten the screw while pressing the End Plate.

- Under environments such as vibration, use an end plates even with a single Fiber Amplifier Unit.
- The maximum numbers of connectable Amplifier Units are given in the following table.

	Maximum number of interconnected	Maximum number of mutual interference prevention
E3X-HD series Standard type (E3X-HD11/HD41/HD6/HD8)	16	10
E3X-HD0	With E3X-ECT	30
	With E3X-CRT	16
E3X-SD series (E3X-SD21/SD51/SD7/SD9)	16	5

- If Units are to be connected, the ambient temperature will change with the number of Units that are connected. Check the Ratings and Characteristics specifications.
- Always turn OFF the power before connecting or disconnecting Units.

Mounting Fiber Units

■ Use Fiber Cutter

Cut a thin fiber as follows. For standard fibers, insert to the desired cutting position and cut.

(1)	The fiber is shipped loosely tightened as shown in the figure at the right	Thin Fiber Attachment (E39-F9) Loosely tighten.
(2)	Adjust the fiber to the desired length and fully tighten.	Fully tighten.
(3)	Insert the Fiber Unit into E39-F4 and cut it.	Fiber Cutter E39-F4 Thin-diameter Fiber Unit Hole x 2 Standard Fiber Unit Hole (dia. 2.2 mm) x 3
(4)	Finished state. (Correctly cut end)	About 0.5 mm Insertion direction Note: The insertion direction into the Fiber Amplifier Unit is shown in the above figure.

■ Mount Fiber Unit

1. Open the protective cover.
2. Raise the lock lever.
3. Insert the Fiber Unit in the fiber unit hole to the bottom.
4. Return the lock lever to the original position and fix the Fiber Unit.

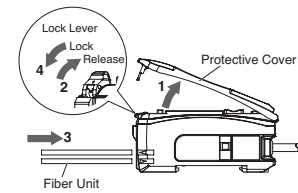

- When mounting a coaxial reflective Fiber Unit, insert the single-core Fiber Unit to the upper hole (Emitter side) and the multi-core Fiber Unit to the lower hole (Receiver side).

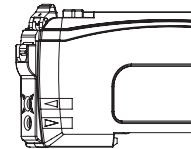
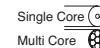

- When removing the Fiber Unit, follow the above steps in reverse order. To maintain the characteristics of the Fiber Unit, make sure the lock is released before removing the Fiber Unit.

Threaded

Cylindrical

Flat

Sleeved

Small Spot

High Power

Narrow
view

BGS

Retro-
reflectiveLimited-
reflectiveChemical-
resistant,
Oil-resistant

Bending

Heat-
resistantArea
Detection

Liquid-level

Vacuum

FPD,
Semi,
Solar

Fiber Units

Warning

This product is not designed or rated for ensuring safety of persons either directly or indirectly.
Do not use it for such purposes.



Precautions for Correct Use

Do not use the Fiber Unit in atmospheres or environments that exceed product ratings.

- **Mounting**

- **Tightening Force**

Refer to pages 56 to 59 for the tightening torque to apply when mounting a Fiber Unit.

<Threaded Models>

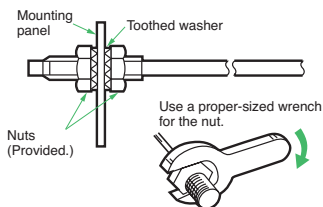

<Cylindrical Models>

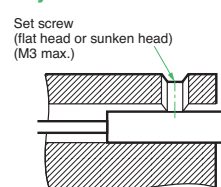

<Chemical and Oil-resistant Models>

The following method is recommended for mounting Fiber Units with fluororesin-covered sensing heads (E32-T F and E32-D F) to prevent from cracking the fluororesin case.

If you use a set screw to secure the Fiber Unit, tighten it with care to prevent from cracking the case.

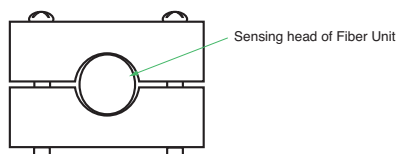

Connections

- Do not subject the Fiber Unit to excessive force, such as tension or compression.
Refer to pages 56 to 59 for tensile strengths.
- Make sure any bend in the Fiber Unit is larger than the allowable bending radius.
Refer to pages 56 to 59 for bending radius ratings and length of unbendable sections at the base of the Fiber Unit.
- Do not compress or place heavy loads on the fibers.

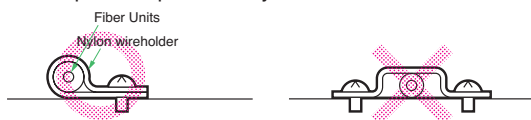

- The method shown below is an effective way to prevent the Fiber Unit from breaking due to vibration.

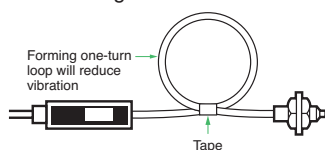

Sleeve Bender (E39-F11)

- The bending radius of the stainless steel tube should be as large as possible. The smaller the bending radius is, the shorter the sensing distance will be.

- Insert the tip of the stainless steel tube in the Sleeve Bender and slowly bend the tube along the curve of the Sleeve Bender.

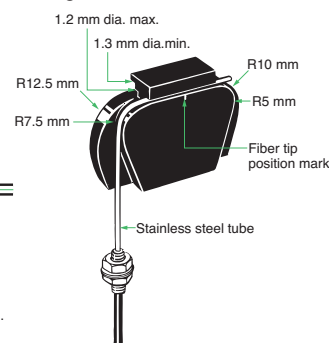
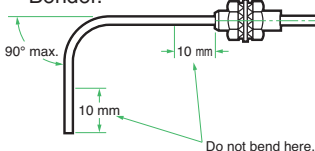

Heat-resistant Fiber Units (E32-D51(R) and E32-T51(R))

The fibers of these Units cannot be extended using the E39-F10 Fiber Connector.

E32-T14

These Units may enter the light-ON state if there are reflective objects at the end of the lenses.

If reflection is a problem, attach the black stickers provided to the ends of the lenses.

E32-T16PR

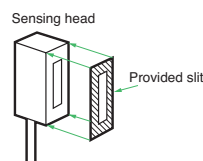

To use the provided slit, peel off the backing sheet, align the slit with the edges of the sensing surface, and attach it to the sensing head.

Use the slit in applications where saturation occurs (i.e., changes in incident level cannot be detected) due to short sensing distances.

Vacuum-resistant Fiber Units (E32-□V)

Although the Flanges, the Fiber Units on the vacuum side, and the Lens Units have been cleaned, as an extra precaution, clean these with alcohol before using them in high-vacuum environments to ensure that they are properly degreased.

Liquid-level Detection Fiber Unit (E32-D82F1)

- Secure the Fiber Unit using the unbendable section.
Otherwise, the liquid-level detection position may be displaced.
- For applications in hazardous environments, install the Fiber Unit in the hazardous environment but install the Amplifier Unit in a safe environment.

Liquid-level Detection Fiber Units (Tube-mounting Models)

- Make sure that the tube is not deformed when using a band to secure the Fiber Unit.

● **Adjustment**

Detection Position for Liquid-level Detection Fiber Unit (E32-D82F1)

The liquid-level detection position is 5.2 ±2 mm from the end of the fluororesin section. (Refer to the diagram on the right.)

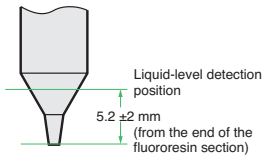

The liquid-level detection position varies with the surface tension of the liquid and the degree of wetness at the Fiber Unit's detection position.

● **Other Precautions**

Liquid-level Detection Fiber Unit (E32-D82F1)

- Operation may become unstable in the following cases:
 1. Bubbles stick to the cone of the sensing head.
 2. Solute deposits on the cone of the sensing head.
 3. The liquid has a high viscosity.
- There are some liquids, such as milky white liquids, for which detection is not possible.
- Do not let the end of the fluororesin section bump into other objects.
Damage to or deformation of the sensing head may cause unstable operation.

Chemical and Oil-resistant, Liquid-level Detection Fiber Unit (E32-D82F1)

Fluororesin shows strong chemical-resistant properties but is permeable if exposed to atmospheres with gaseous chemicals or water vapors, resulting in failure or damage. Confirm applicability sufficiently before using the Fiber Unit in these environments.

Accessories

Use of E39-R3 Reflector Provided with E32-R21

1. Use detergent to remove any dust or oil from the surfaces where tape is applied. Adhesive tape will not be attached properly if oil or dust remains on the surface.
2. The E39-R3 cannot be used in areas that are exposed to oil or chemicals.

Mounting method of Protective Spiral Tubes

1. Insert the Fiber Unit into the Protective Spiral Tube from the head connector (threaded).
2. Push the fiber into the Protective Spiral Tube. The tube must be straight so that the fiber enters without twisting. Turn the Protective Spiral Tube, not the fiber.
3. Secure the Protective Spiral Tube to the mounting panel with the provided nuts.

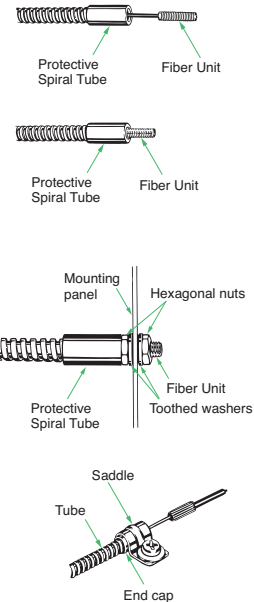

4. Use the provided saddle to secure the end cap of the Protective Spiral Tube. (To secure the Protective Spiral Tube at a position other than the end cap, apply tape to the tube so that the portion becomes thicker in diameter.)

Attaching the E39-F10 Fiber Connector

Attach the Fiber Connector as shown in the following figures.

1. Insert the Fiber Unit in the retention clip.
2. Insert the retention clip into the splice.

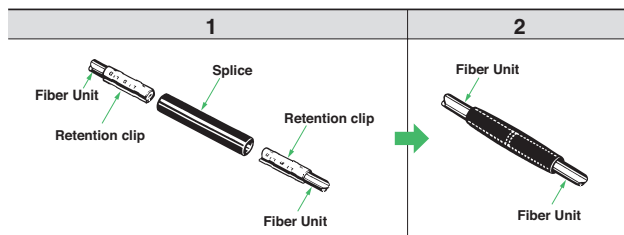

- The Fiber Units should be as close as possible when they are connected.
The sensing distance is reduced by approximately 25% when Fiber Units are extended by the connector.
- Only 2.2-mm-diameter fibers can be connected.

Threaded

Cylindrical

Flat

Sleeved

Small Spot

High Power

Narrow
view

BGS

Retro-
reflectiveLimited-
reflectiveChemical-
resistant,
Oil-resistant

Bending

Heat-
resistantArea
Detection

Liquid-level

Vacuum

FPD,
Semi,
Solar

Models	Specifications	Dimensions
E32-A		
E32-A01 5M	P.48	P.49 (49-A)
E32-A03 2M	P.28	P.29 (29-A)
	P.54	P.55 (55-A)
E32-A03-1 2M	P.28	P.29 (29-B)
	P.54	P.55 (55-B)
E32-A04 2M	P.28	P.29 (29-C)
	P.54	P.55 (55-C)
E32-A08 2M	P.34	P.35 (35-C)
	P.52	P.53 (53-B)
E32-A08H2 3M	P.44	P.45 (45-D)
	P.52	P.53 (53-C)
E32-A09 2M	P.34	P.35 (35-F)
	P.52	P.53 (53-E)
E32-A09H2 2M	P.44	P.45 (45-E)
	P.52	P.53 (53-F)
E32-A12 2M	P.34	P.35 (35-D)
	P.52	P.53 (53-D)
E32-C		
E32-C11N 2M	P.08 (P.20)	P.09 (09-B) (P.21)
E32-C31 2M	P.08 (P.18, 20, 32)	P.09 (09-D) (P.19, 21, 33)
E32-C31M 1M	P.08	P.09 (09-E)
E32-C31N 2M	P.08 (P.18, 20)	P.09 (09-A) (P.19, 21)
E32-C41 1M	P.20	P.21 (21-A) (21-D)
E32-C42 1M	P.18	P.19 (19-A) (19-B)
E32-C42S 1M	P.18	P.19 (19-E)
E32-CC200 2M	P.08 (P.20)	P.09 (09-H) (P.21)
E32-D		
E32-D11 2M	P.40	P.41 (41-E)
E32-D11R 2M	P.08	P.09 (09-G)
E32-D11U 2M	P.36	P.37 (37-I)
E32-D12F 2M	P.36	P.37 (37-H)
E32-D15XR 2M	P.14	P.15 (15-D)
E32-D15YR 2M	P.14	P.15 (15-E)
E32-D15ZR 2M	P.14	P.15 (15-F)
E32-D16 2M	P.22	P.23 (23-C)
E32-D21 2M	P.40	P.41 (41-B)
E32-D21R 2M	P.08	P.09 (09-F)
E32-D21B 2M	P.40	P.41 (41-D)
E32-D21R 2M	P.08	P.09 (09-C)
E32-D221B 2M	P.12	P.13 (13-D) (41-C)
	P.40	P.41 (41-C)
E32-D22B 2M	P.12	P.13 (13-A)
	P.40	P.41 (41-A)
E32-D22R 2M	P.12	P.13 (13-C)
E32-D24R 2M	P.16	P.17 (17-E)
E32-D25XB 2M	P.40	P.41 (41-F)
E32-D32L 2M	P.12	P.13 (13-E)
E32-D33 2M	P.12	P.13 (13-F) (17-H)
	P.16	P.17 (17-H)
E32-D331 2M	P.16	P.17 (17-G)
E32-D36P1 2M	P.46	P.47 (47-D)
E32-D36T 5M	P.48	P.49 (49-C)
E32-D43M 1M	P.12	P.13 (13-B) (17-F)
	P.16	P.17 (17-F)
E32-D51 2M	P.44	P.45 (45-B)
E32-D51R 2M	P.44	P.45 (45-A)
E32-D61-S 2M	P.44	P.45 (45-G)

Models	Specifications	Dimensions
E32-D611-S 2M	P.44	P.45 (45-F)
E32-D73-S 2M	P.44	P.45 (45-H)
E32-D81R-S 2M	P.44	P.45 (45-C)
E32-D82F1 4M	P.48	P.49 (49-D)
E32-DC200BR 2M	P.16	P.17 (17-J)
E32-DC200F4R 2M	P.16	P.17 (17-I)
E32-L		
E32-L11FP 5M	P.36	P.37 (37-F)
	P.52	P.53 (53-G)
E32-L11FS 5M	P.36	P.37 (37-G)
	P.52	P.53 (53-H)
E32-L15 2M	P.18	P.19 (19-F)
E32-L16-N 2M	P.30	P.31 (31-A)
	P.34	P.35 (35-B)
	P.52	P.53 (53-A)
E32-L24S 2M	P.30	P.31 (31-B)
	P.34	P.35 (35-A)
E32-L25L 2M	P.30	P.31 (31-C)
	P.34	P.35 (35-E)
E32-L25T 2M	P.48	P.49 (49-B)
E32-R		
E32-R16 5M	P.32	P.33 (33-B)
E32-R21 2M	P.32	P.33 (33-C)
E32-T		
E32-T10V 2M	P.50	P.51 (51-D)
E32-T11 2M	P.38 (P.24)	P.39 (39-C) (P.25, 26)
E32-T11F 2M	P.36	P.37 (37-C)
E32-T11N 2M	P.06 (P.24)	P.07 (07-A) (P.25)
E32-T11NF 2M	P.36	P.37 (37-A)
E32-T11R 2M	P.06 (P.24)	P.07 (07-B) (P.25, 26)
E32-T12F 2M	P.36	P.37 (37-B)
E32-T12R 2M	P.10	P.11 (11-C)
E32-T14 2M	P.22	P.23 (23-B)
E32-T14F 2M	P.36	P.37 (37-D)
E32-T14LR 2M	P.10	P.11 (11-D)
E32-T15XR 2M	P.14	P.15 (15-A)
E32-T15YR 2M	P.14	P.15 (15-B)
E32-T15ZR 2M	P.14	P.15 (15-C)
E32-T16JR 2M	P.46	P.47 (47-B)
E32-T16PR 2M	P.46	P.47 (47-A)
E32-T16WR 2M	P.46	P.47 (47-C)
E32-T17L 10M	P.22	P.23 (23-A)
E32-T21 2M	P.38	P.39 (39-B)
E32-T223R 2M	P.10	P.11 (11-A)
E32-T22B 2M	P.10	P.11 (11-B)
	P.38	P.39 (39-A)
E32-T22S 2M	P.28	P.29 (29-F)
E32-T24E 2M	P.16	P.17 (17-B)
E32-T24R 2M	P.16	P.17 (17-A)
E32-T24S 2M	P.28	P.29 (29-E)
	P.54	P.55 (55-E)
E32-T24SR 2M	P.28	P.29 (29-D) (55-D)
	P.54	P.55 (55-D)
E32-T25XB 2M	P.38	P.39 (39-D)
E32-T33 1M	P.16	P.17 (17-C)
E32-T51 2M	P.42 (P.26)	P.43 (43-B) (P.27)
E32-T51F 2M	P.36	P.37 (37-E)
E32-T51R 2M	P.42 (P.26)	P.43 (43-A) (P.27)
E32-T51V 1M	P.50	P.51 (51-A)

Models	Specifications	Dimensions
E32-T61-S 2M	P.42 (P.26)	P.43 (43-D) (P.27)
E32-T81R-S 2M	P.42 (P.26)	P.43 (43-C) (P.27)
E32-T84SV 1M	P.50	P.51 (51-C)
E32-TC200BR 2M	P.16	P.17 (17-D)
E32-V		
E32-VF1	P.50	P.51 (51-F)
E32-VF4	P.50	P.51 (51-E)
E39-F		
E39-F1	P.24, 26	P.24 (24-A)
E39-F1-33	P.26	P.26 (26-D)
E39-F11	P.17	—
E39-F16	P.24, 26	P.24 (24-B)
E39-F17	P.18	P.19 (19-B)
E39-F18	P.20	P.21 (21-G) (21-H)
E39-F1V	P.50	P.51 (51-B)
E39-F2	P.24, 26	P.24 (24-C)
E39-F32A	P.40	P.41 (41-G)
E39-F32C	P.38	P.39 (39-E)
	P.40	P.41 (41-G)
E39-F32D	P.40	P.41 (41-G)
E39-F3A	P.18	P.19 (19-A)
E39-F3A-5	P.20	P.21 (21-A) (21-B) (21-C)
E39-F3B	P.20	P.21 (21-D) (21-E) (21-F)
E39-F3C	P.18	P.19 (19-C) (19-D)
E39-F3R	P.32	P.33 (33-A)
E39-R		
E39-R1	—	P.33 (33-B)
E39-R3	—	P.33 (33-C)
E39-RP37	P.32	P.33 (33-A)
E39-L		
E39-L143	—	P.77 (77-A)
E3X-CN		
E3X-CN11	P.76	P.76 (76-A)
E3X-CN12	P.76	P.76 (76-B)
E3X-CRT		
E3X-CRT	P.70	P.71 (71-A)
E3X-ECT		
E3X-ECT	P.70	P.71 (71-B)
E3X-HD		
E3X-HD0	P.64	P.65 (65-B)
E3X-HD11 2M	P.64	P.64 (64-A)
E3X-HD41 2M	P.64	P.64 (64-A)
E3X-HD6	P.64	P.65 (65-A)
E3X-HD8	P.64	P.65 (65-A)
E3X-SD		
E3X-SD21 2M	P.72	P.73 (73-A)
E3X-SD51 2M	P.72	P.73 (73-A)
E3X-SD7	P.72	P.73 (73-B)
E3X-SD9	P.72	P.73 (73-B)
PFP		
PFP-100N	—	P.77 (77-B)
PFP-100N2	—	P.77 (77-C)
PFP-50N	—	P.77 (77-B)
PFP-M	—	P.77 (77-D)

READ AND UNDERSTAND THIS DOCUMENT

Please read and understand this document before using the products. Please consult your OMRON representative if you have any questions or comments.

WARRANTY

OMRON's exclusive warranty is that the products are free from defects in materials and workmanship for a period of one year (or other period if specified) from date of sale by OMRON.

OMRON MAKES NO WARRANTY OR REPRESENTATION, EXPRESS OR IMPLIED, REGARDING NON-INFRINGEMENT, MERCHANTABILITY, OR FITNESS FOR PARTICULAR PURPOSE OF THE PRODUCTS. ANY BUYER OR USER ACKNOWLEDGES THAT THE BUYER OR USER ALONE HAS DETERMINED THAT THE PRODUCTS WILL SUITABLY MEET THE REQUIREMENTS OF THEIR INTENDED USE. OMRON DISCLAIMS ALL OTHER WARRANTIES, EXPRESS OR IMPLIED.

LIMITATIONS OF LIABILITY

OMRON SHALL NOT BE RESPONSIBLE FOR SPECIAL, INDIRECT, OR CONSEQUENTIAL DAMAGES, LOSS OF PROFITS OR COMMERCIAL LOSS IN ANY WAY CONNECTED WITH THE PRODUCTS, WHETHER SUCH CLAIM IS BASED ON CONTRACT, WARRANTY, NEGLIGENCE, OR STRICT LIABILITY.

In no event shall responsibility of OMRON for any act exceed the individual price of the product on which liability is asserted.

IN NO EVENT SHALL OMRON BE RESPONSIBLE FOR WARRANTY, REPAIR, OR OTHER CLAIMS REGARDING THE PRODUCTS UNLESS OMRON'S ANALYSIS CONFIRMS THAT THE PRODUCTS WERE PROPERLY HANDLED, STORED, INSTALLED, AND MAINTAINED AND NOT SUBJECT TO CONTAMINATION, ABUSE, MISUSE, OR INAPPROPRIATE MODIFICATION OR REPAIR.

SUITABILITY FOR USE

THE PRODUCTS CONTAINED IN THIS DOCUMENT ARE NOT SAFETY RATED. THEY ARE NOT DESIGNED OR RATED FOR ENSURING SAFETY OF PERSONS, AND SHOULD NOT BE RELIED UPON AS A SAFETY COMPONENT OR PROTECTIVE DEVICE FOR SUCH PURPOSES. Please refer to separate catalogs for OMRON's safety rated products.

OMRON shall not be responsible for conformity with any standards, codes, or regulations that apply to the combination of products in the customer's application or use of the product.

At the customer's request, OMRON will provide applicable third party certification documents identifying ratings and limitations of use that apply to the products. This information by itself is not sufficient for a complete determination of the suitability of the products in combination with the end product, machine, system, or other application or use.

The following are some examples of applications for which particular attention must be given. This is not intended to be an exhaustive list of all possible uses of the products, nor is it intended to imply that the uses listed may be suitable for the products:

- Outdoor use, uses involving potential chemical contamination or electrical interference, or conditions or uses not described in this document.
- Nuclear energy control systems, combustion systems, railroad systems, aviation systems, medical equipment, amusement machines, vehicles, safety equipment, and installations subject to separate industry or government regulations.
- Systems, machines, and equipment that could present a risk to life or property.

Please know and observe all prohibitions of use applicable to the products.

NEVER USE THE PRODUCTS FOR AN APPLICATION INVOLVING SERIOUS RISK TO LIFE OR PROPERTY WITHOUT ENSURING THAT THE SYSTEM AS A WHOLE HAS BEEN DESIGNED TO ADDRESS THE RISKS, AND THAT THE OMRON PRODUCT IS PROPERLY RATED AND INSTALLED FOR THE INTENDED USE WITHIN THE OVERALL EQUIPMENT OR SYSTEM.

PERFORMANCE DATA

Performance data given in this document is provided as a guide for the user in determining suitability and does not constitute a warranty. It may represent the result of OMRON's test conditions, and the users must correlate it to actual application requirements. Actual performance is subject to the OMRON Warranty and Limitations of Liability.

CHANGE IN SPECIFICATIONS

Product specifications and accessories may be changed at any time based on improvements and other reasons.

It is our practice to change model numbers when published ratings or features are changed, or when significant construction changes are made. However, some specifications of the product may be changed without any notice. When in doubt, special model numbers may be assigned to fix or establish key specifications for your application on your request. Please consult with your OMRON representative at any time to confirm actual specifications of purchased products.

DIMENSIONS AND WEIGHTS

Dimensions and weights are nominal and are not to be used for manufacturing purposes, even when tolerances are shown.

ERRORS AND OMISSIONS

The information in this document has been carefully checked and is believed to be accurate; however, no responsibility is assumed for clerical, typographical, or proofreading errors, or omissions.

PROGRAMMABLE PRODUCTS

OMRON shall not be responsible for the user's programming of a programmable product, or any consequence thereof.

COPYRIGHT AND COPY PERMISSION

This document shall not be copied for sales or promotions without permission.

This document is protected by copyright and is intended solely for use in conjunction with the product. Please notify us before copying or reproducing this document in any manner, for any other purpose. If copying or transmitting this document to another, please copy or transmit it in its entirety.

OMRON Corporation Industrial Automation Company

Tokyo, JAPAN

Contact: www.ia.omron.com

Regional Headquarters

OMRON EUROPE B.V.

Sensor Business Unit

Carl-Benz-Str. 4, D-71154 Nufringen, Germany
Tel: (49) 7032-811-0/Fax: (49) 7032-811-199

OMRON ELECTRONICS LLC

One Commerce Drive Schaumburg,
IL 60173-5302 U.S.A.
Tel: (1) 847-843-7900/Fax: (1) 847-843-7787

OMRON ASIA PACIFIC PTE. LTD.

No. 438A Alexandra Road # 05-05/08 (Lobby 2),
Alexandra Technopark,
Singapore 119967
Tel: (65) 6835-3011/Fax: (65) 6835-2711

OMRON (CHINA) CO., LTD.

Room 2211, Bank of China Tower,
200 Yin Cheng Zhong Road,
PuDong New Area, Shanghai, 200120, China
Tel: (86) 21-5037-2222/Fax: (86) 21-5037-2200

Authorized Distributor:

© OMRON Corporation 2012 All Rights Reserved.
In the interest of product improvement,
specifications are subject to change without notice.

Cat. No. E418-E1-01 CSM_1_1_0212 0212 (0212) (W)