

## Metallized Polypropylene Film Capacitors

### Type: **EZPE Series**

#### ■ Features

- High safety, Self-healing and Self-protecting function built-in
- Long product life, High reliability
- Low loss, Low ESR
- Flame retardant (Case and sealing resin)
- RoHS directive compliant

#### ■ Recommended Applications

For DC filtering, DC link circuit

- Solar inverters
- Wind power generation
- Industrial power supplies
- Inverter circuit in appliances (Air Conditioners etc.)



#### ■ Construction

- Dielectric : Polypropylene film
- Electrodes : Metallized dielectric with segmented pattern
- Plastic case : UL94 V-0
- Sealing : UL94 V-0
- Terminals : Tinned wires, 2-pin and 4-pin versions

#### ■ Explanation of Part Numbers

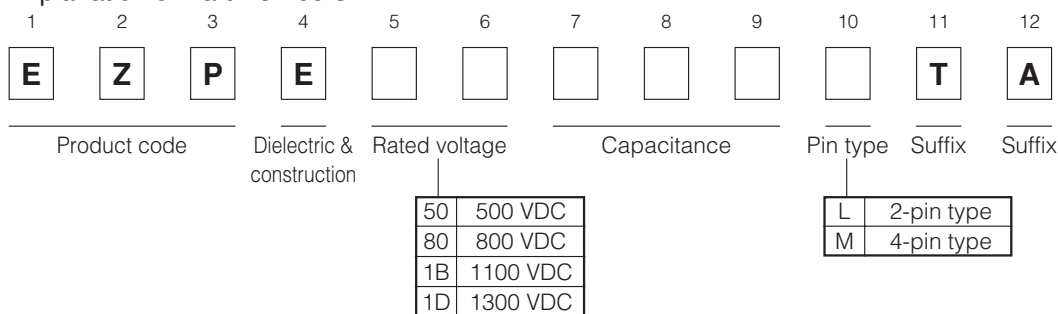

#### ■ Specifications

Category temperature range (T <sub>c</sub> ) (*1)	-40 °C to +85 °C	
Rated voltage(V <sub>R</sub> ) (*2)	500 VDC, 800 VDC, 1100 VDC, 1300 VDC (Derating of rated voltage by more than 70 °C (*3))	
Rated capacitance (C <sub>R</sub> )	500 VDC	10 μF to 110 μF
	800 VDC	10 μF to 60 μF
	1100 VDC	10 μF to 40 μF
	1300 VDC	10 μF to 25 μF
Capacitance tolerance	±10 %	
Withstanding DC voltage	Between terminals:Rated voltage. (VDC)×150 % 10 s Terminal to case:2110 VAC 10 s	
Insulation resistance (CR)	CR≥10000 Ω · F (20 °C, 500 VDC, 60 s)	

\*1:The temperature of capacitor surface (case)

\*2:Use for DC voltage only

\*3:Refer to the page of " DC voltage derating "

■ Dimensions in mm (not to scale)

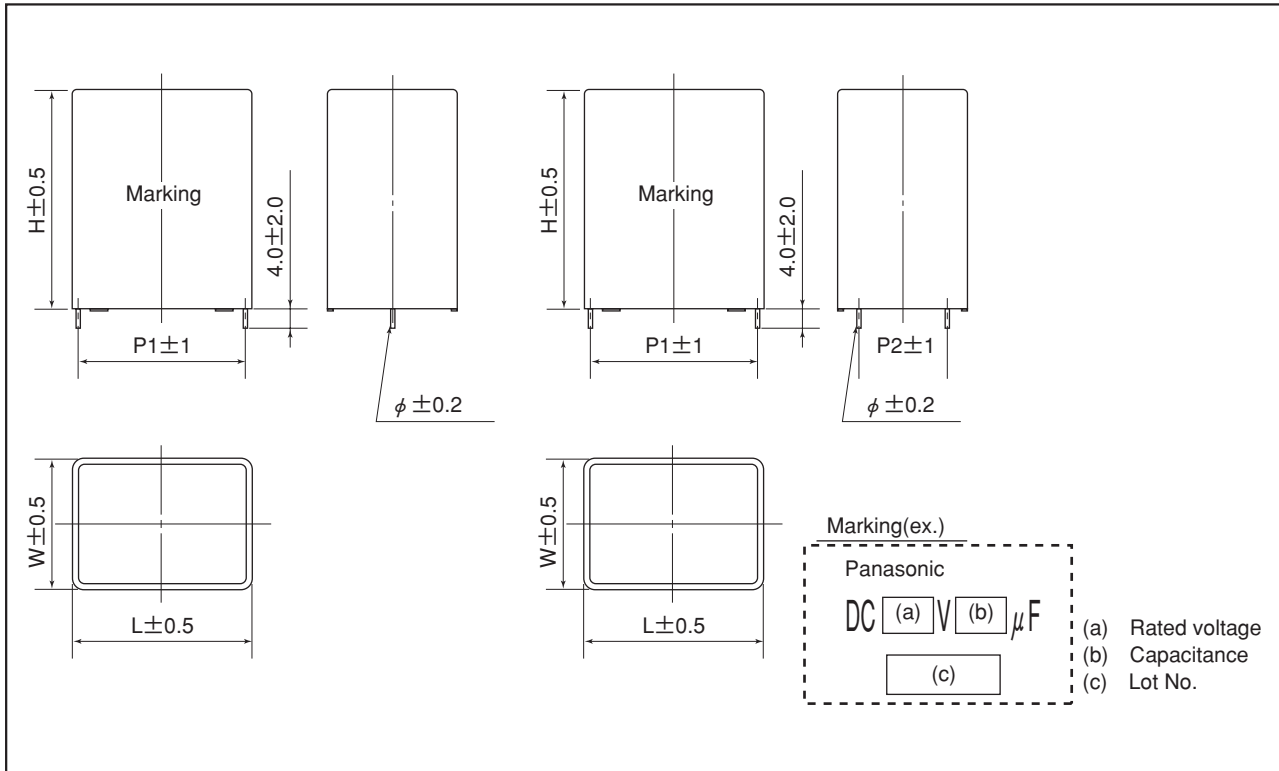

■ Rating, Dimensions & Quantity / Ammo Box

● Type EZPE Rated voltage : 500 VDC at 70 °C ( 450VDC at 85 °C )

Part No.	CR. ( $\mu$ F)	Dimensions (mm)						dv/dt [V/ $\mu$ s]	Permissible current		ESR <sub>typ</sub> [m $\Omega$ ] (*3)	tan $\delta$ [%] (*4)	Mass [g]	MOQ [pcs] (*5)
		W	H	L	P1	P2	$\phi$		Peak Current [A <sub>o-p</sub> ] (*1)	RMS Current [A <sub>rms</sub> ] (*2)				
EZPE50106LTA	10	20	42	41.5	37.5	-	1.2	21	210	5.0	22.0	0.28	45	600
EZPE50156LTA	15	20	42	41.5	37.5	-	1.2	21	315	7.5	14.8	0.28	45	
EZPE50206LTA	20	20	42	41.5	37.5	-	1.2	21	420	9.5	11.0	0.28	44	
EZPE50256LTA	25	20	42	41.5	37.5	-	1.2	21	525	11.0	8.8	0.28	43	
EZPE50306MTA	30	20	42	41.5	37.5	10.2	1.2	21	630	12.5	7.0	0.28	43	
EZPE50356MTA	35	30	51	41.5	37.5	10.2	1.2	21	735	13.5	6.2	0.28	83	400
EZPE50406MTA	40	30	51	41.5	37.5	10.2	1.2	21	840	14.5	5.4	0.28	82	
EZPE50456MTA	45	30	51	41.5	37.5	10.2	1.2	21	945	15.2	4.9	0.28	81	
EZPE50506MTA	50	30	51	41.5	37.5	20.3	1.2	21	1050	16.0	4.4	0.28	80	
EZPE50556MTA	55	30	51	41.5	37.5	20.3	1.2	21	1155	16.3	4.1	0.28	79	
EZPE50606MTA	60	30	51	41.5	37.5	20.3	1.2	21	1260	16.5	3.9	0.28	77	200
EZPE50656MTA	65	30	51	57.5	52.5	10.2	1.2	14	910	15.0	6.8	0.44	111	
EZPE50706MTA	70	30	51	57.5	52.5	10.2	1.2	14	980	15.5	6.5	0.44	109	
EZPE50756MTA	75	30	51	57.5	52.5	20.3	1.2	14	1050	16.0	6.0	0.44	108	
EZPE50806MTA	80	30	51	57.5	52.5	20.3	1.2	14	1120	16.5	5.7	0.44	106	
EZPE50856MTA	85	35	56	57.5	52.5	20.3	1.2	14	1190	16.7	5.4	0.44	142	200
EZPE50906MTA	90	35	56	57.5	52.5	20.3	1.2	14	1260	17.0	5.1	0.44	141	
EZPE50956MTA	95	35	56	57.5	52.5	20.3	1.2	14	1330	17.5	4.9	0.44	140	
EZPE50107MTA	100	35	56	57.5	52.5	20.3	1.2	14	1400	18.0	4.7	0.44	139	
EZPE50117MTA	110	35	56	57.5	52.5	20.3	1.2	14	1540	18.5	4.4	0.44	138	

\*1:When rising temperature of capacitor surface by continuous peak current (included pulse current), use within limit specified for temperature of capacitor surface and self heating temperature rise.

\*2:Maximum RMS current @ 70 °C, 10 kHz

Use within limit for self heating temperature rise at capacitor surface.

\*3:Typical values @ 20°C, 10 kHz ESR : less than 2.5 × ESR<sub>typ</sub>

\*4:Maximum dissipation factor @20°C, 1 kHz

\*5:Minimum order quantity consists of 4 packing units.

■ Rating, Dimensions & Quantity / Ammo Box

● Type EZPE Rated voltage : 800 VDC at 70 °C ( 700VDC at 85 °C )

Part No.	CR. ( $\mu$ F)	Dimensions (mm)						dv/dt [V/ $\mu$ s]	Permissible current		ESR <sub>typ</sub> [m $\Omega$ ] (*3)	tan $\delta$ [%] (*4)	Mass [g]	MOQ [pcs] (*5)
		W	H	L	P1	P2	$\phi$		Peak Current [A <sub>p-p</sub> ] (*1)	RMS Current [A <sub>rms</sub> ] (*2)				
EZPE80106LTA	10	20	42	41.5	37.5	-	1.2	22	220	7.0	15.8	0.22	44	600
EZPE80156MTA	15	20	42	41.5	37.5	10.2	1.2	22	330	9.0	10.5	0.22	43	
EZPE80206MTA	20	30	51	41.5	37.5	10.2	1.2	22	440	11.0	7.7	0.22	82	400
EZPE80256MTA	25	30	51	41.5	37.5	10.2	1.2	22	550	13.0	6.4	0.22	80	
EZPE80306MTA	30	30	51	41.5	37.5	20.3	1.2	22	660	15.0	5.3	0.22	78	200
EZPE80356MTA	35	30	51	57.5	52.5	10.2	1.2	15	525	12.0	9.7	0.33	110	
EZPE80406MTA	40	30	51	57.5	52.5	20.3	1.2	15	600	13.0	8.3	0.33	107	
EZPE80456MTA	45	30	51	57.5	52.5	20.3	1.2	15	675	14.0	7.0	0.33	104	
EZPE80506MTA	50	35	56	57.5	52.5	20.3	1.2	15	750	15.0	6.3	0.33	140	
EZPE80556MTA	55	35	56	57.5	52.5	20.3	1.2	15	825	16.0	5.9	0.33	138	
EZPE80606MTA	60	35	56	57.5	52.5	20.3	1.2	15	900	17.0	5.6	0.33	136	

● Type EZPE Rated voltage : 1100 VDC at 70 °C ( 920VDC at 85 °C )

Part No.	CR. ( $\mu$ F)	Dimensions (mm)						dv/dt [V/ $\mu$ s]	Permissible current		ESR <sub>typ</sub> [m $\Omega$ ] (*3)	tan $\delta$ [%] (*4)	Mass [g]	MOQ [pcs] (*5)
		W	H	L	P1	P2	$\phi$		Peak Current [A <sub>p-p</sub> ] (*1)	RMS Current [A <sub>rms</sub> ] (*2)				
EZPE1B106MTA	10	20	42	41.5	37.5	10.2	1.2	54	540	7.0	12.3	0.20	43	600
EZPE1B156MTA	15	30	51	41.5	37.5	10.2	1.2	54	810	8.5	8.2	0.20	80	
EZPE1B206MTA	20	30	51	41.5	37.5	20.3	1.2	54	1080	10.0	6.3	0.20	76	400
EZPE1B256MTA	25	30	51	57.5	52.5	10.2	1.2	35	875	8.0	10.7	0.28	107	
EZPE1B306MTA	30	30	51	57.5	52.5	20.3	1.2	35	1050	9.0	8.5	0.28	103	200
EZPE1B356MTA	35	35	56	57.5	52.5	20.3	1.2	35	1225	10.0	7.2	0.28	137	
EZPE1B406MTA	40	35	56	57.5	52.5	20.3	1.2	35	1400	11.0	6.5	0.28	134	

● Type EZPE Rated voltage : 1300 VDC at 70 °C ( 1100VDC at 85 °C )

Part No.	CR. ( $\mu$ F)	Dimensions (mm)						dv/dt [V/ $\mu$ s]	Permissible current		ESR <sub>typ</sub> [m $\Omega$ ] (*3)	tan $\delta$ [%] (*4)	Mass [g]	MOQ [pcs] (*5)
		W	H	L	P1	P2	$\phi$		Peak Current [A <sub>p-p</sub> ] (*1)	RMS Current [A <sub>rms</sub> ] (*2)				
EZPE1D106MTA	10	30	51	41.5	37.5	10.2	1.2	73	730	12.0	10.0	0.17	80	400
EZPE1D156MTA	15	30	51	57.5	52.5	10.2	1.2	50	750	10.0	14.5	0.22	109	
EZPE1D206MTA	20	30	51	57.5	52.5	20.3	1.2	50	1000	14.0	11.1	0.22	103	200
EZPE1D256MTA	25	35	56	57.5	52.5	20.3	1.2	50	1250	17.0	8.5	0.22	136	

\*1:When rising temperature of capacitor surface by continuous peak current (included pulse current), use within limit specified for temperature of capacitor surface and self heating temperature rise.

\*2:Maximum RMS current @ 70 °C, 10 kHz  
Use within limit for self heating temperature rise at capacitor surface.

\*3:Typical values @ 20°C, 10 kHz ESR : less than 2.5 × ESR<sub>typ</sub>

\*4:Maximum dissipation factor @20°C, 1 kHz

\*5:Minimum order quantity consists of 4 packing units.

## ■ Permissible Conditions

### ● Permissible Voltage

- These capacitors are designed only for DC voltage, so should not be used for AC line.
- Use the peak voltage ( $V_{o-p}$ ) within the rated voltage.
- Use the peak to peak voltage ( $V_{p-p}$ ) within  $0.2 \times V_R$ .

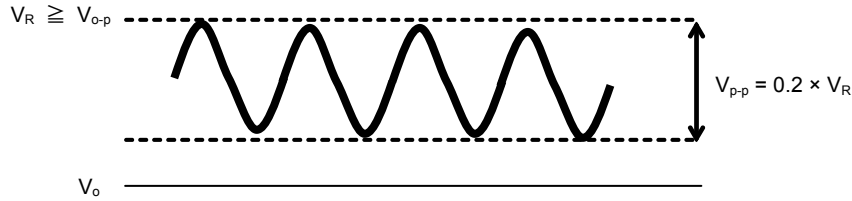

### ● DC Voltage, Peak current and RMS current derating

Derating of voltage ( $V_{o-p}$ ), RMS current ( $A_{rms}$ ), and peak current ( $A_{o-p}$ ) according to the following diagram when the temperature of the capacitor surface exceeds 70 °C.

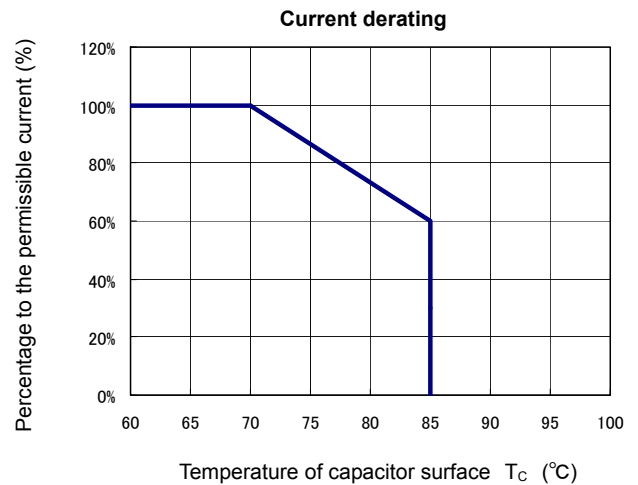
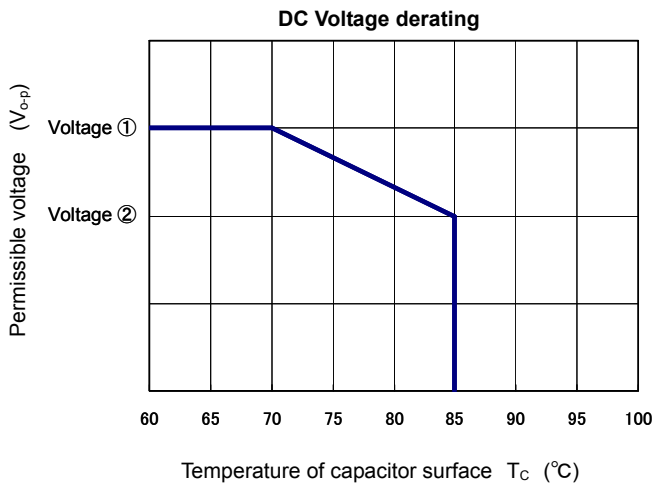

Part Number	Voltage ①	Voltage ②
EZPE50 □□□□ TA	DC500V	DC450V
EZPE80 □□□□ TA	DC800V	DC700V
EZPE1B □□□□ TA	DC1100V	DC920V
EZPE1D □□□□ TA	DC1300V	DC1100V

### ● Permissible self heating temperature rise

Permissible self heating temperature rise is within following diagram when the temperature of the capacitor surface exceeds 70 °C.

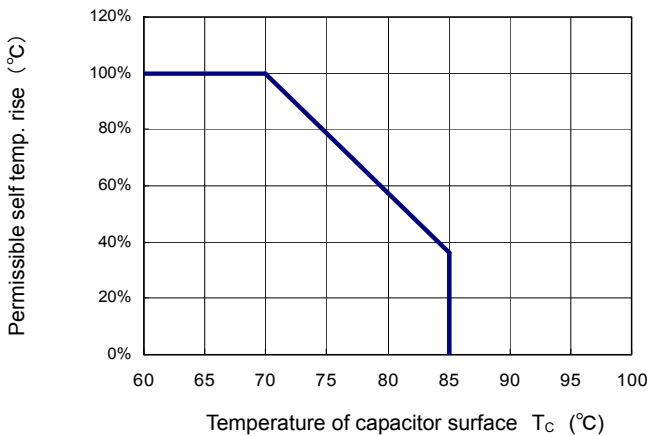

### ● Total cycles applied peak current

Total cycles applied peak current ( $A_{o-p}$ ) (including pulse current) are within following diagram.

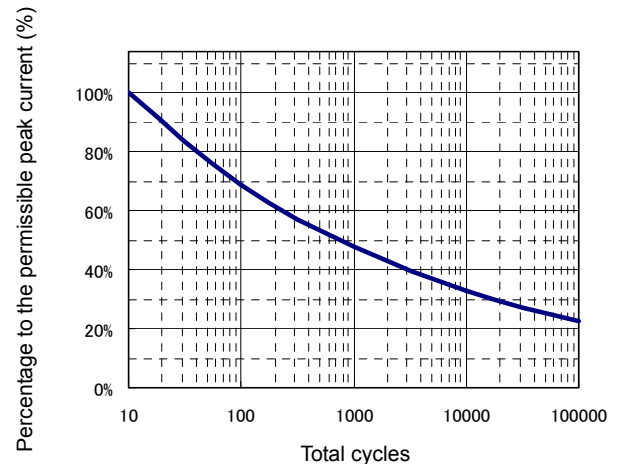

Part Number	100% at 70°C	36% at 85°C
EZPE50 □□□□ TA	12 °C	4.3 °C
EZPE80 □□□□ TA	10 °C	3.6 °C
EZPE1B □□□□ TA	5 °C	1.8 °C
EZPE1D □□□□ TA	9 °C	3.2 °C

Please consult Panasonic if your condition exceeds the above spec.

## ■ Characteristics <Reference>

● Type EZPE Rated voltage : 500 VDC at 70 °C ( 450VDC at 85 °C )

## ● Temperature Characteristics

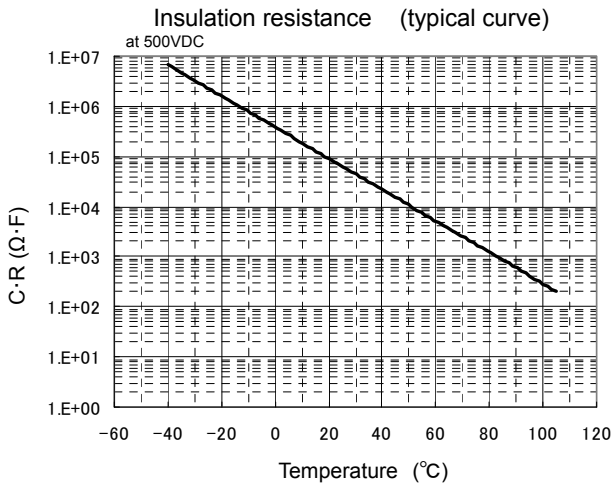
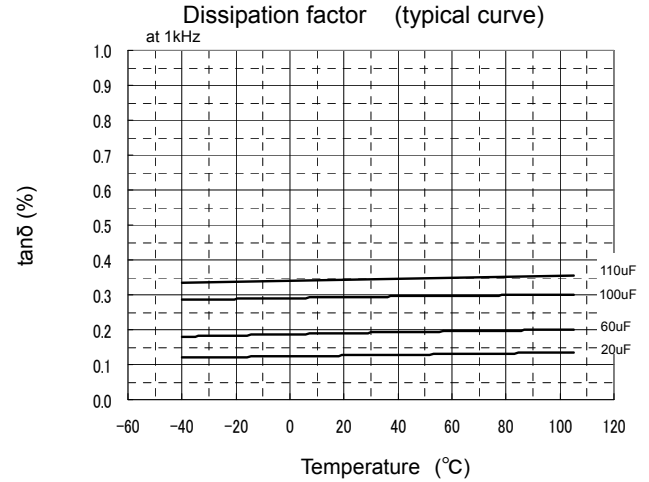
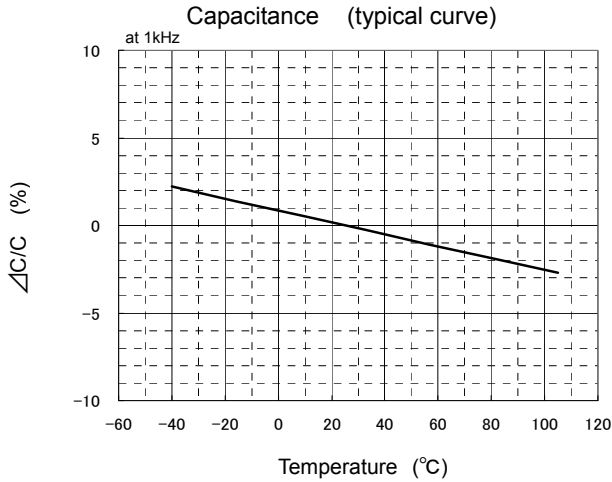

## ● Frequency Characteristics

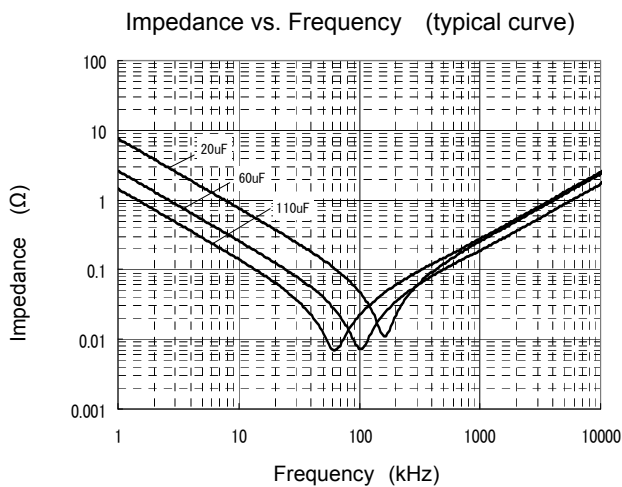

## ● Lifetime expectancy

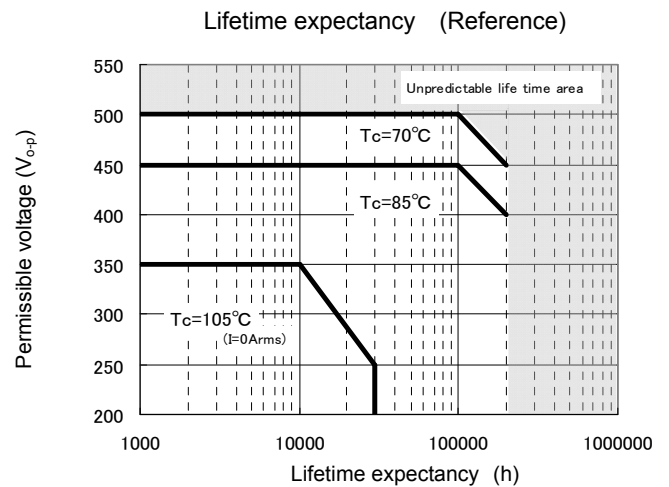

\* Life time : Reach ΔC/C = - 10 % , Judgement of Panasonic  
\* 105°C : Not guarantee voltage

## ■ Characteristics <Reference>

● Type EZPE Rated voltage : 800 VDC at 70 °C ( 700VDC at 85 °C )

## ● Temperature Characteristics

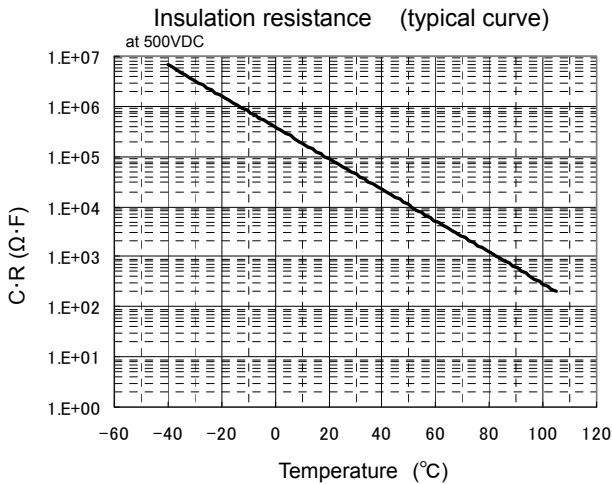
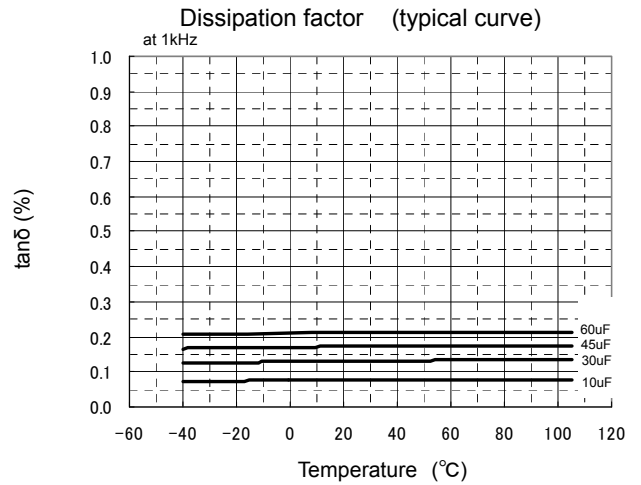
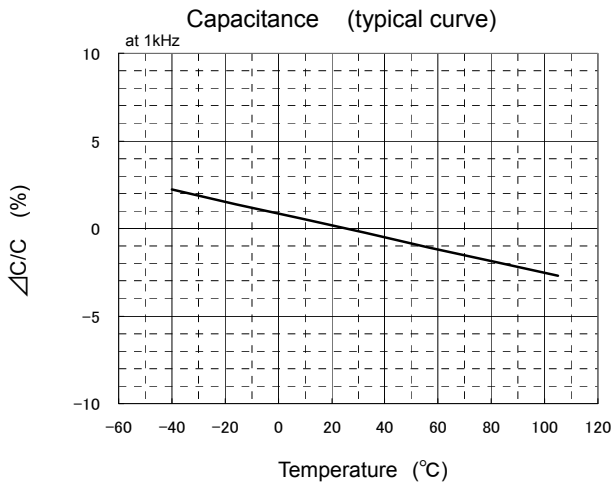

## ● Frequency Characteristics

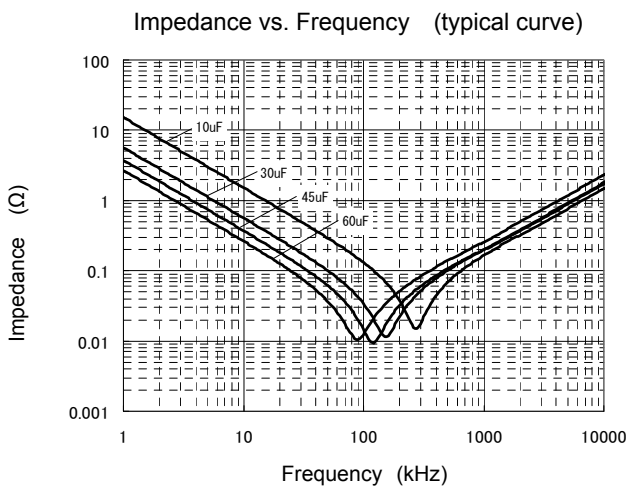

## ● Lifetime expectancy

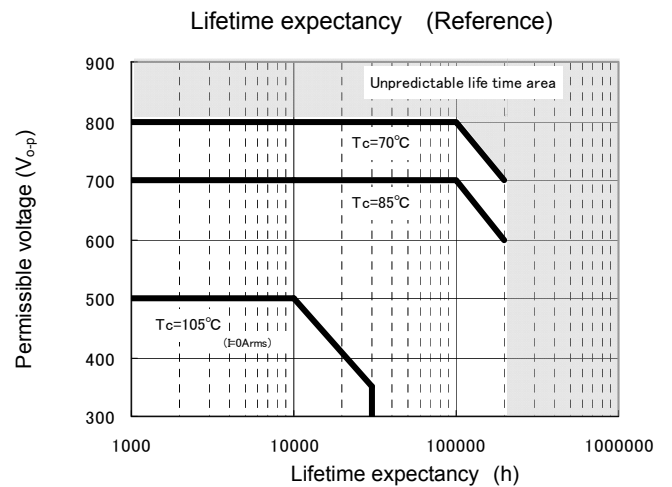

\* Life time : Reach ΔC/C = - 10 % , Judgement of Panasonic  
\* 105°C : Not guarantee voltage

## ■ Characteristics <Reference>

● Type EZPE Rated voltage : 1100 VDC at 70 °C ( 920VDC at 85 °C )

## ● Temperature Characteristics

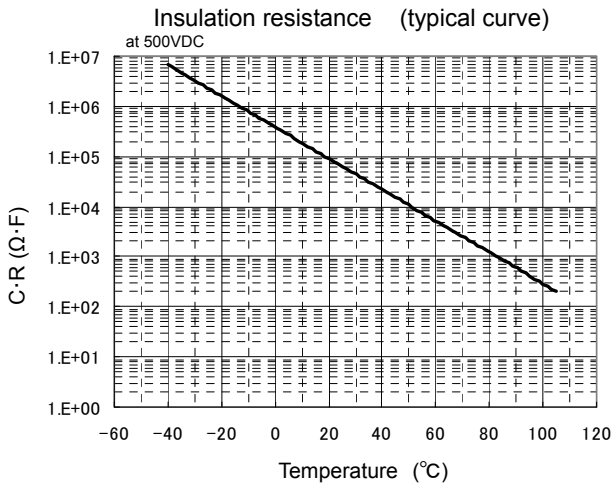
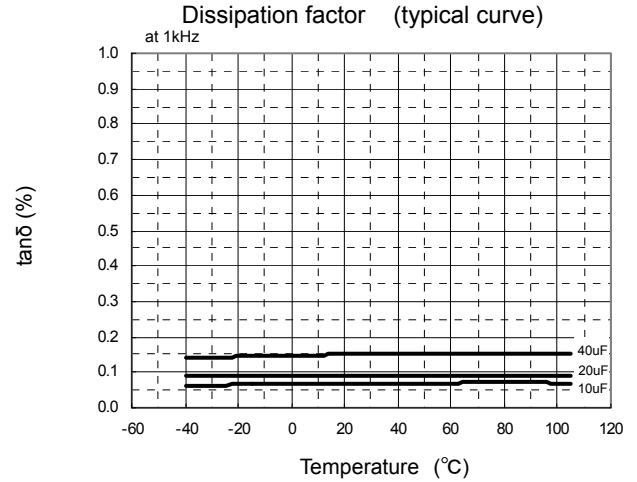
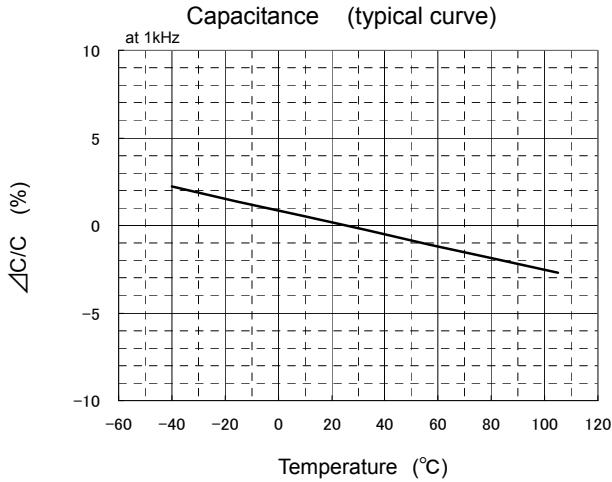

## ● Frequency Characteristics

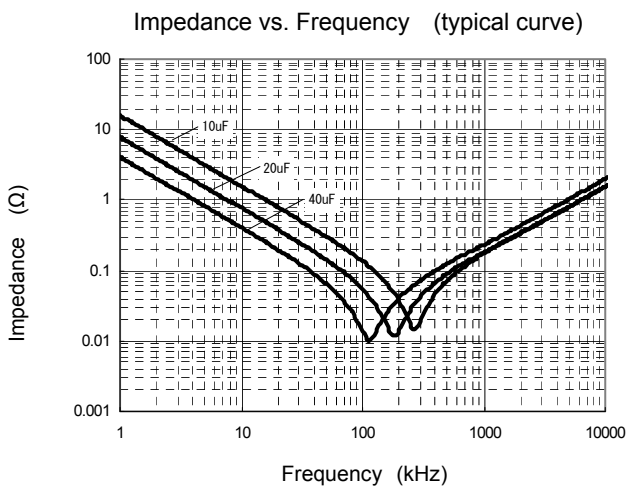

## ● Lifetime expectancy

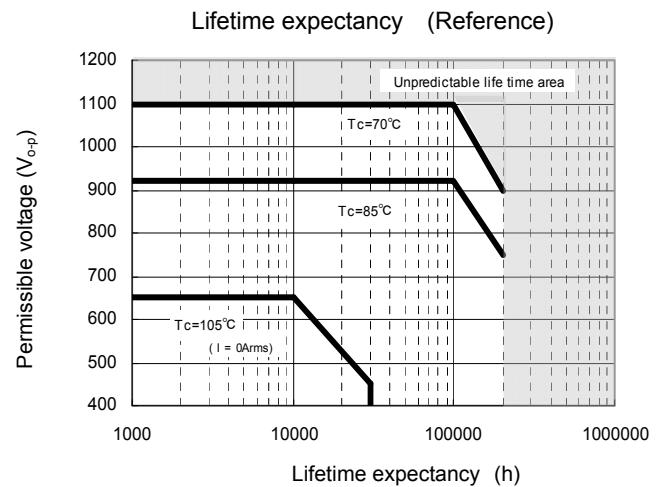

\* Life time : Reach ΔC/C = - 10 % , Judgement of Panasonic  
\* 105°C : Not guarantee voltage

## ■ Characteristics <Reference>

● Type EZPE Rated voltage : 1300 VDC at 70 °C ( 1100VDC at 85 °C )

## ● Temperature Characteristics

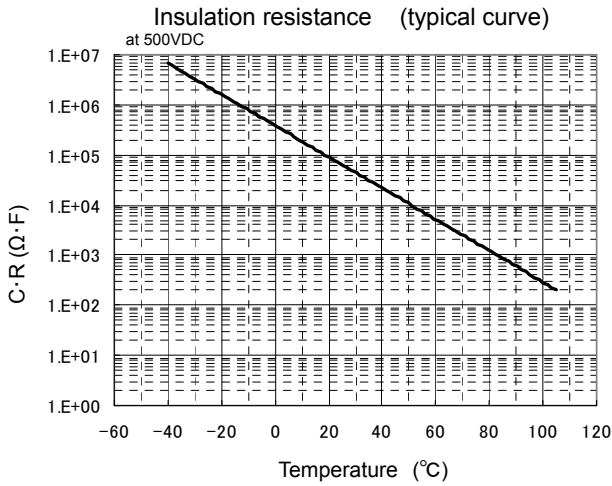
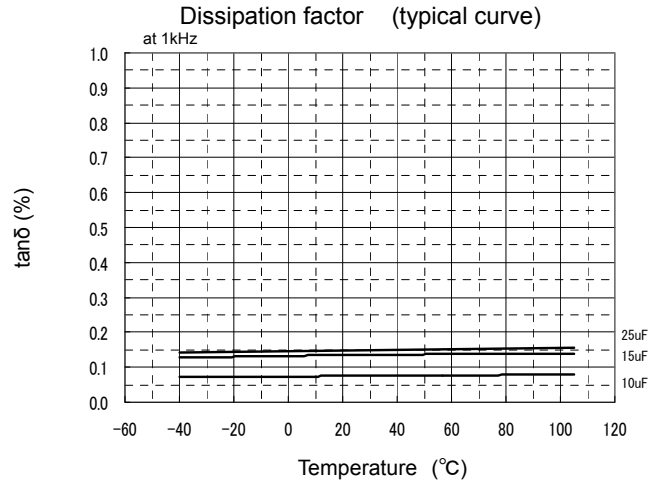
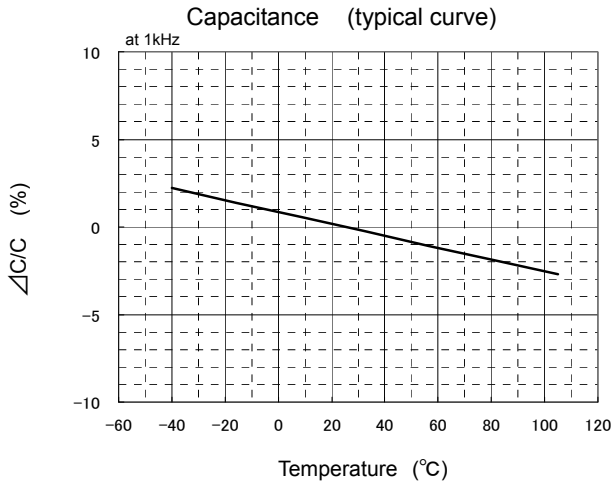

## ● Frequency Characteristics

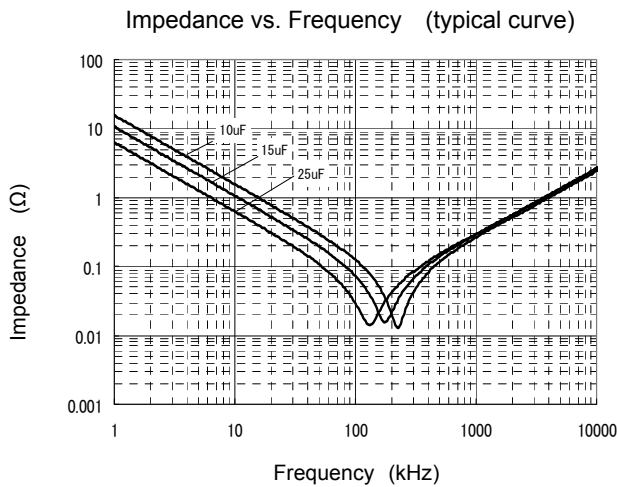

## ● Lifetime expectancy

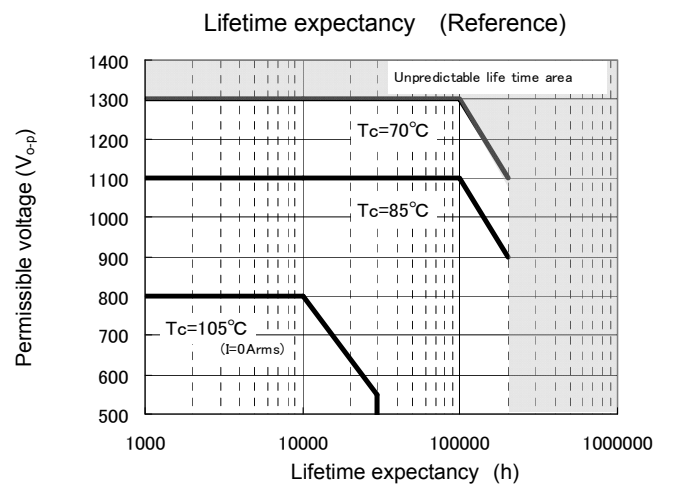

\* Life time : Reach  $\Delta C/C = -10\%$  , Judgement of Panasonic  
\*  $105^\circ\text{C}$  : Not guarantee voltage