



**Compact DIP type SSR**  
**Ideal for AC load control**

AQ-H RELAYS

### FEATURES

1. Supports 0.3 A, 0.6 A, 0.9 A and 1.2 A ON-state RMS currents.
2. The 1.2 A type saves space with a DIP 8-pin package.

4. High dielectric strength: 5,000 V AC (between input and output)
5. Two types available: Zero-cross type and Random type

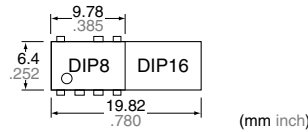
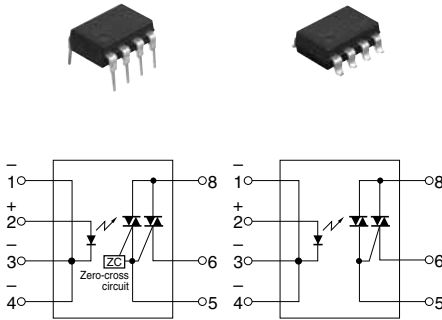

3. Handles both 100 and 200 V AC loads

This relay handles both voltages in a single product. It is not necessary for users that use both types to manage separate part numbers.

### TYPICAL APPLICATIONS

1. Home appliances (air conditioner, microwave oven, washing machine, personal hygiene system, refrigerator, fan heater, inductive heating cooker, rice cooker and humidifier, etc.)
2. Industrial equipment

RoHS compliant

### TYPES

Type	Output rating*		Type	Part No.				Packing quantity			
				Through hole terminal	Surface-mount terminal						
	Repetitive peak OFF-state voltage	ON-state RMS current			Tube packing style	Tube packing style	Tape and reel packing style		Tube	Tape and reel	
AC type	600 V	0.3 A	Zero-cross	AQH0213	AQH0213A	AQH0213AX	AQH0213AZ	1 tube contains 50 pcs. 1 batch contains 500 pcs.			1,000 pcs.
				AQH1213	AQH1213A	AQH1213AX	AQH1213AZ				
				AQH2213	AQH2213A	AQH2213AX	AQH2213AZ				
				AQH3213	AQH3213A	AQH3213AX	AQH3213AZ				
		0.6 A	Random	AQH0223	AQH0223A	AQH0223AX	AQH0223AZ				
				AQH1223	AQH1223A	AQH1223AX	AQH1223AZ				
				AQH2223	AQH2223A	AQH2223AX	AQH2223AZ				
				AQH3223	AQH3223A	AQH3223AX	AQH3223AZ				
				0.9 A	1.2 A						

\* Indicate the repetitive peak OFF-state voltage and ON-state RMS current: peak AC.  
Note: For space reasons, the SMD terminal shape indicator "A" and the package type indicator "X" and "Z" are omitted from the seal.

### RATING

#### 1. Absolute maximum ratings (Ambient temperature: 25°C 77°F)

Item	Symbol	AQH0213, AQH0223	AQH1213, AQH1223	AQH2213, AQH2223	AQH3213, AQH3223	Remarks
Input	LED forward current	50 mA				
	LED reverse voltage	6 V				
	Peak forward current	1 A				f = 100 Hz, Duty Ratio = 0.1%
Output	Repetitive peak OFF-state voltage	600 V				
	ON-state RMS current	0.3 A	0.6 A	0.9 A	1.2 A	
	Non-repetitive surge current	3 A	6 A	9 A	12 A	60Hz, 1 cycle
I/O isolation voltage	V <sub>iso</sub>	5,000 V AC				
Operating temperature	T <sub>opr</sub>	-30°C to +85°C -22°F to +185°F				Non-condensing at low temperatures
Storage temperature	T <sub>stg</sub>	-40°C to +125°C -40°F to +257°F				

Note: "A", "AX" and "AZ" at the end of the part numbers have been omitted.

2. Characteristics (Ambient temperature: 25°C 77°F)

Item		Symbol	AQH0213, AQH1213, AQH2213, AQH3213	AQH0223, AQH1223, AQH2223, AQH3223	Remarks
Input	LED dropout voltage	Typical	1.21 V		I <sub>F</sub> = 20 mA
		Maximum	1.3 V		
	LED reverse current	Typical	—		V <sub>R</sub> = 6 V
		Maximum	10 μA		
	Peak OFF-state current	Typical	—		I <sub>F</sub> = 0 mA V <sub>DRM</sub> = 600 V
		Maximum	100 μA		
Output	Peak ON-state voltage	Typical	—		I <sub>F</sub> = 10 mA I <sub>TM</sub> = Max.
		Maximum	2.5 V		
	Holding current	Typical	—		
		Maximum	25 mA		
	Critical rate of rise of OFF-state voltage	Minimum	200 V/μs		V <sub>DRM</sub> = 600 V × 1/√2
Transfer characteristics	Trigger LED current	Maximum	10 mA		V <sub>O</sub> = 6 V R <sub>L</sub> = 100 Ω
	Zero-cross voltage	Maximum	50 V		I <sub>F</sub> = 10 mA
	Turn on time*	Maximum	100 μs		I <sub>F</sub> = 20 mA V <sub>O</sub> = 6 V R <sub>L</sub> = 100 Ω
	I/O isolation resistance	Minimum	50 GΩ		500 V DC

Notes: 1. For type of connection, see page 4.  
2. "A", "AX" and "AZ" at the end of the part numbers have been omitted.

\*Turn on time

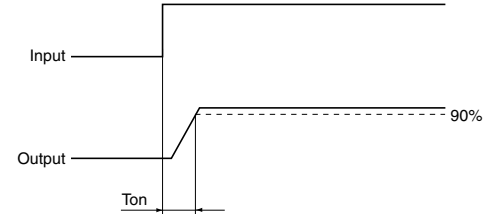

RECOMMENDED OPERATING CONDITIONS

Please follow the conditions below in order to ensure accurate operation and release of the phototriac coupler.

Item	Symbol	Value	Unit
Input LED current	I <sub>F</sub>	20	mA

REFERENCE DATA

1. ON-state RMS current vs. Ambient temperature characteristics

Allowable ambient temperature: -30°C to +85°C -22°F to +185°F

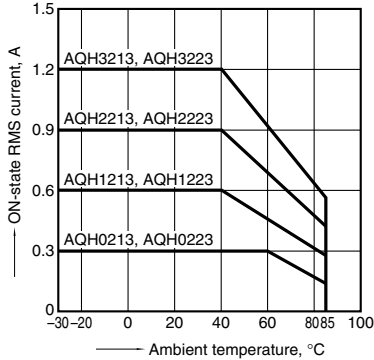

2. Peak ON-state voltage vs. Ambient temperature characteristics

LED current: 10 mA; ON current: Max. Measured portion: between terminals 6 and 8

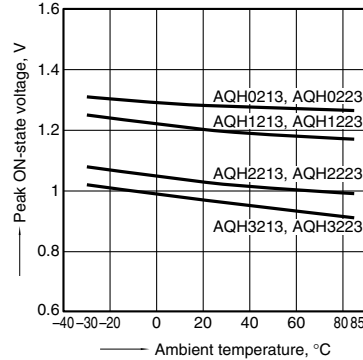

3. Trigger LED current vs. Ambient temperature characteristics

Load voltage: 6 V DC; Load resistance: 100Ω

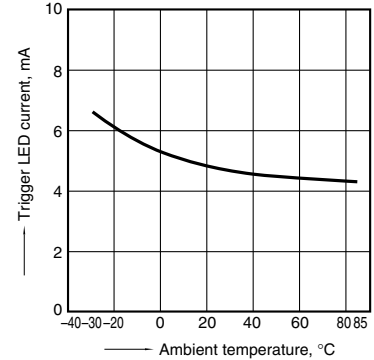

4. LED dropout voltage vs. Ambient temperature characteristics

LED current: 10 to 50 mA

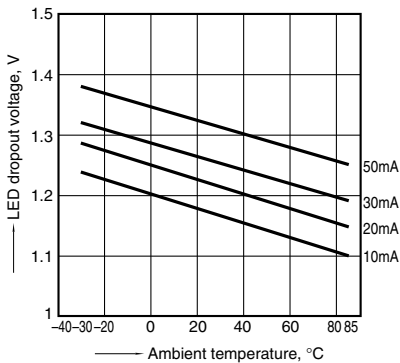

5. Turn on time vs. LED current characteristics

Load voltage: 6 V DC; Load resistance: 100Ω Measured portion: between terminals 6 and 8

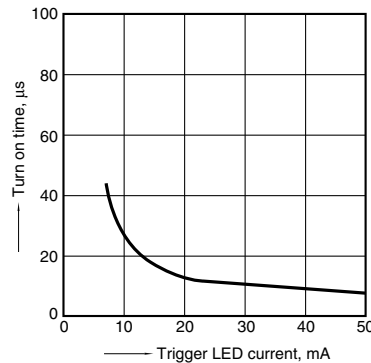

6. Repetitive peak OFF-state current vs. Load voltage characteristics

Ambient temperature: 25°C 77°F; Measured portion: between terminals 6 and 8; LED current: 0 mA

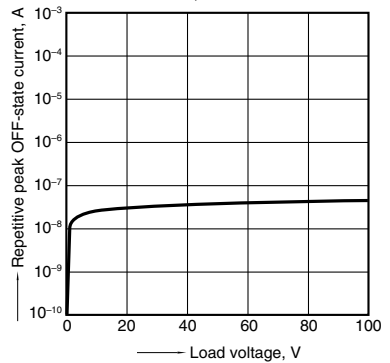

7. Hold current vs. Ambient temperature characteristics

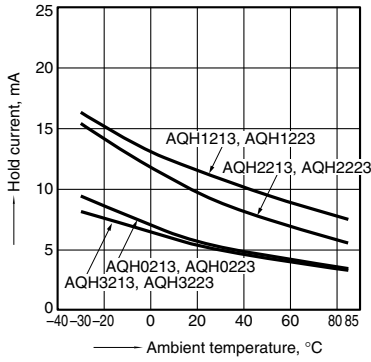

8. Zero-cross voltage vs. Ambient temperature characteristics

LED current: 10 mA

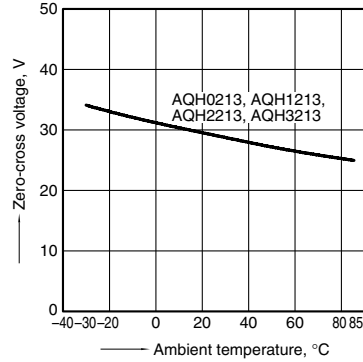

**DIMENSIONS** (mm inch)

The CAD data of the products with a **CAD Data** mark can be downloaded from: <http://industrial.panasonic.com/ac/e/>

**Through hole terminal type**

**CAD Data**

External dimensions

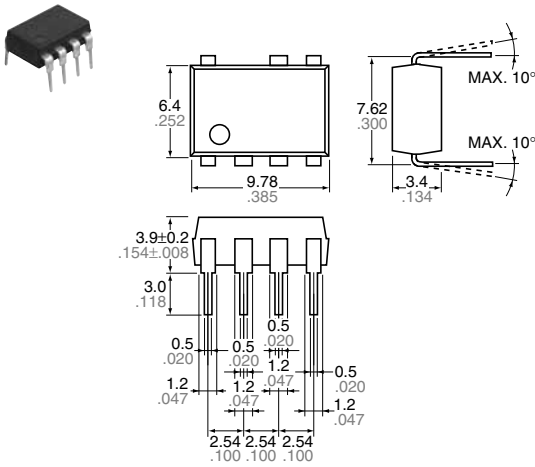

Terminal thickness: 0.25 .010  
General tolerance:  $\pm 0.1 \pm .004$

PC board pattern (BOTTOM VIEW)

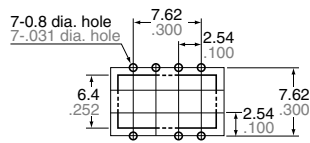

Tolerance:  $\pm 0.1 \pm .004$

**Surface mount terminal type**

**CAD Data**

External dimensions

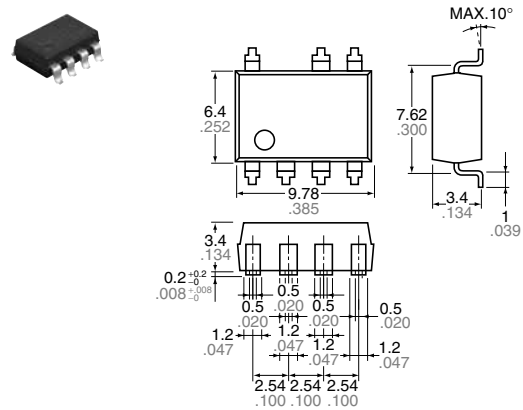

Terminal thickness: 0.25 .010  
General tolerance:  $\pm 0.1 \pm .004$

Recommended mounting pad (TOP VIEW)

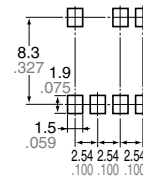

Tolerance:  $\pm 0.1 \pm .004$

# SCHEMATIC AND WIRING DIAGRAMS

Notes:  $E_1$ : Power source at input side;  $I_F$ : Trigger LED forward current;  $V_L$ : Load voltage;  $I_L$ : Load current

Schematic	Output configuration	Load	Wiring diagram	
<p>10 + 20 - 30 - 40</p> <p>Zero-cross circuit</p> <p>8 6 5</p>	<p>1a</p>	<p>AC</p>	<p>1 8 2 3 6 4 5</p> <p><math>E_1</math> <math>I_F</math></p> <p>Load <math>V_L</math> (AC) <math>I_L</math></p>	<p><math>V_L</math> (AC) <math>I_L</math> Load</p>
<p>10 + 20 - 30 - 40</p> <p>Zero-cross circuit</p> <p>8 6 5</p>				