

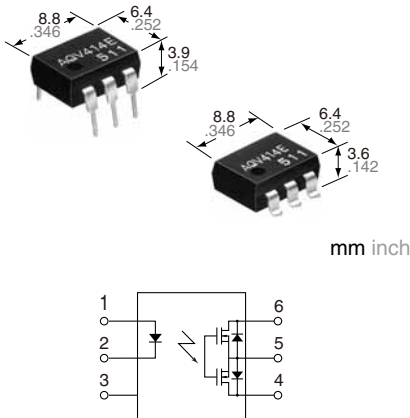

**Normally closed 6-pin type
of 400V load voltage**

**PhotoMOS®
GU 1 Form B
(AQV414)**



RoHS compliant

FEATURES

1. Low on-resistance (typ. 26Ω) for normally-closed type

This has been achieved thanks to the built-in MOSFET processed by our proprietary method, DSD (Double-diffused and Selective Doping) method.

3. High sensitivity and low on-resistance

Can control max. 0.15 A load current with 5 mA input current.

4. Low-level off state leakage current of max. 1 μA

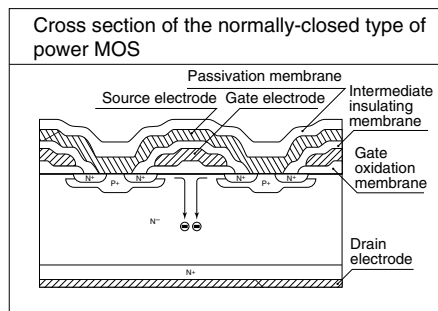

2. Controls low-level analog signals

PhotoMOS feature extremely low closed-circuit offset voltage to enable control of low-level analog signals without distortion.

TYPICAL APPLICATIONS

- Security equipment
- Telephone equipment (Dial pulse)
- Measuring instruments

TYPES

	I/O isolation voltage	Output rating*		Package	Part No.				Packing quantity	
		Load voltage	Load current		Through hole terminal	Surface-mount terminal		Tube	Tape and reel	
						Tube packing style	Tape and reel packing style			
						Picked from the 1/2/3-pin side	Picked from the 4/5/6-pin side			
AC/DC dual use	1,500 V AC	400 V	120 mA	DIP6-pin	AQV414	AQV414A	AQV414AX	AQV414AZ	1 tube contains: 50 pcs. 1 batch contains: 500 pcs.	1,000 pcs.

*Indicate the peak AC and DC values.

Note: The surface mount terminal shape indicator "A" and the packing style indicator "X" or "Z" are not marked on the device.

RATING

1. Absolute maximum ratings (Ambient temperature: 25°C 77°F)

Item	Symbol	Type of connection	AQV414(A)	Remarks
Input	LED forward current	I _F	50 mA	
	LED reverse voltage	V _R	5 V	
	Peak forward current	I _{FP}	1 A	f = 100 Hz, Duty factor = 0.1%
	Power dissipation	P _{in}	75 mW	
Output	Load voltage (peak AC)	V _L	400 V	
	Continuous load current	I _L	A	0.12 A
			B	0.13 A
			C	0.15 A
	Peak load current	I _{peak}		0.3 A
Power dissipation	P _{out}		500 mW	
Total power dissipation	P _T		550 mW	
I/O isolation voltage	V _{iso}		1,500 V AC	
Temperature limits	Operating	T _{opr}	-40°C to +85°C -40°F to +185°F	Non-condensing at low temperatures
	Storage	T _{stg}	-40°C to +100°C -40°F to +212°F	

GU 1 Form B (AQV414)

2. Electrical characteristics (Ambient temperature: 25°C 77°F)

Item			Symbol	Type of connection	AQV414(A)	Condition
Input	LED operate (OFF) current	Typical	I_{off}	—	1.0 mA	$I_L = \text{Max.}$
		Maximum			3.0 mA	
	LED reverse (ON) current	Minimum	I_{on}	—	0.4 mA	$I_L = \text{Max.}$
		Typical			0.95 mA	
LED dropout voltage	Typical	V_F	—	1.25 V (1.14 V at $I_F = 5 \text{ mA}$)		
	Maximum			1.5 V		
Output	On resistance	Typical	R_{on}	A	26 Ω	$I_F = 0 \text{ mA}$ $I_L = \text{Max.}$ Within 1 s on time
		Maximum			50 Ω	
		Typical	R_{on}	B	20 Ω	$I_F = 0 \text{ mA}$ $I_L = \text{Max.}$ Within 1 s on time
		Maximum			25 Ω	
	Typical	R_{on}	C	10 Ω	$I_F = 0 \text{ mA}$ $I_L = \text{Max.}$ Within 1 s on time	
	Maximum			12.5 Ω		
Off state leakage current	Maximum	I_{leak}	—	1 μA	$I_F = 5 \text{ mA}$ $V_L = \text{Max.}$	
Transfer characteristics	Operate (OFF) time*	Typical	T_{off}	—	0.47 ms	$I_F = 0 \text{ mA} \rightarrow 5 \text{ mA}$ $I_L = 120 \text{ mA}$
		Maximum			1.0 ms	
	Reverse (ON) time*	Typical	T_{on}	—	0.28 ms	$I_F = 5 \text{ mA} \rightarrow 0 \text{ mA}$ $I_L = 120 \text{ mA}$
		Maximum			1.0 ms	
	I/O capacitance	Typical	C_{iso}	—	0.8 pF	$f = 1 \text{ MHz}$ $V_B = 0 \text{ V}$
		Maximum			1.5 pF	
Initial I/O isolation resistance	Minimum	R_{iso}	—	1,000 M Ω	500 V DC	

*Operate/Reverse time

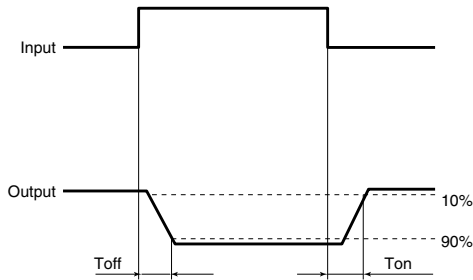

RECOMMENDED OPERATING CONDITIONS

Please obey the following conditions to ensure proper device operation and resetting.

Item	Symbol	Recommended value	Unit
Input LED current	I_F	5	mA

■ These products are not designed for automotive use.

If you are considering to use these products for automotive applications, please contact your local Panasonic Corporation technical representative.

REFERENCE DATA

1. Load current vs. ambient temperature characteristics

Allowable ambient temperature: -40°C to $+85^{\circ}\text{C}$
 -40°F to $+185^{\circ}\text{F}$

Type of connection: A

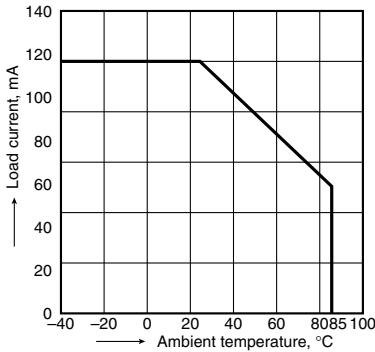

2. On resistance vs. ambient temperature characteristics

Measured portion: between terminals 4 and 6;
 LED current: 0 mA;
 Continuous load current: 120 mA (DC)

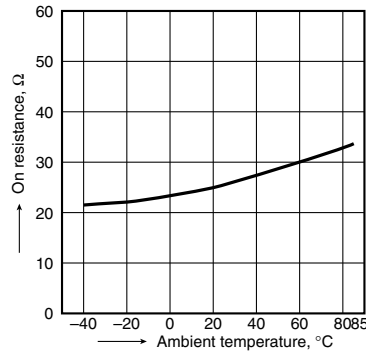

3. Operate (OFF) time vs. ambient temperature characteristics

LED current: 5 mA;
 Load voltage: 400 V (DC);
 Continuous load current: 120 mA (DC)

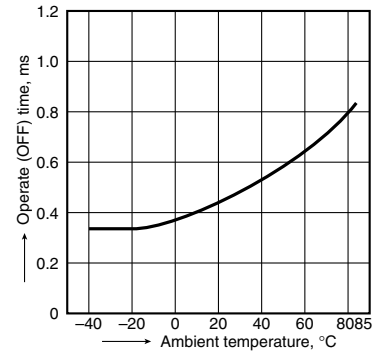

4. Reverse (ON) time vs. ambient temperature characteristics

LED current: 5 mA; Load voltage: 400 V (DC);
 Continuous load current: 120 mA (DC)

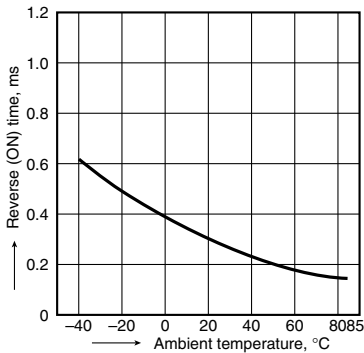

5. LED operate (OFF) current vs. ambient temperature characteristics

Load voltage: 400 V (DC);
 Continuous load current: 120 mA (DC)

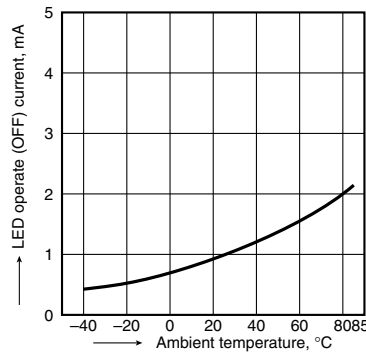

6. LED reverse (ON) current vs. ambient temperature characteristics

Load voltage: 400 V (DC);
 Continuous load current: 120 mA (DC)

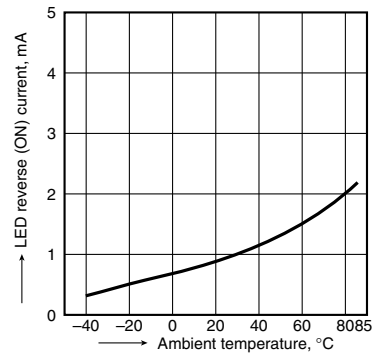

7. LED dropout voltage vs. ambient temperature characteristics

LED current: 5 to 50 mA

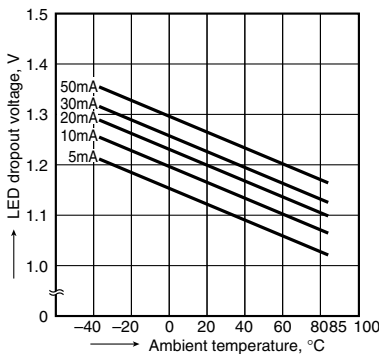

8. Current vs. voltage characteristics of output at MOS portion

Measured portion: between terminals 4 and 6;
 Ambient temperature: 25°C 77°F

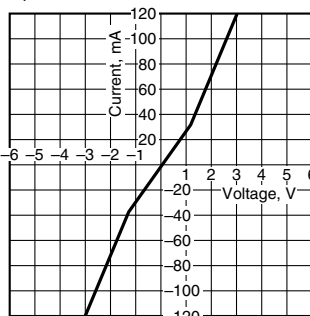

9. Off state leakage current vs. load voltage characteristics

Measured portion: between terminals 4 and 6;
 LED current: 5 mA; Ambient temperature: 25°C 77°F

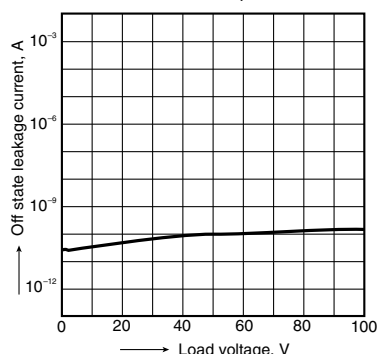

10. Operate (OFF) time vs. LED forward current characteristics

Measured portion: between terminals 4 and 6;
 Load voltage: 400 V (DC); Continuous load current: 120 mA (DC); Ambient temperature: 25°C 77°F

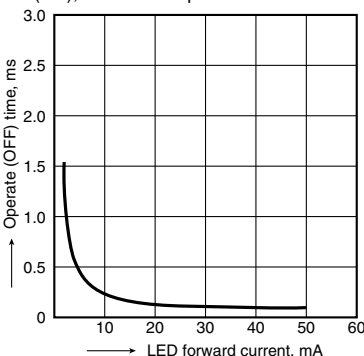

11. Reverse (ON) time vs. LED forward current characteristics

Measured portion: between terminals 4 and 6;
 Load voltage: 400 V (DC); Continuous load current: 120 mA (DC); Ambient temperature: 25°C 77°F

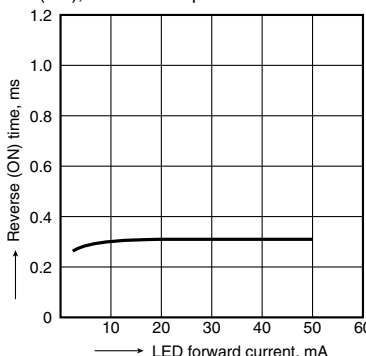

12. Output capacitance vs. applied voltage characteristics

Measured portion: between terminals 4 and 6;
 LED current: 5 mA; Frequency: 1 MHz; Ambient temperature: 25°C 77°F

