

Standard type:  US / Reinforced type:  US 

**Normally closed  
DIP6-pin type  
Low on-resistance with  
250V/400V load voltage**

**PhotoMOS®  
HE 1 Form B  
(AQV45○, AQV454H)**

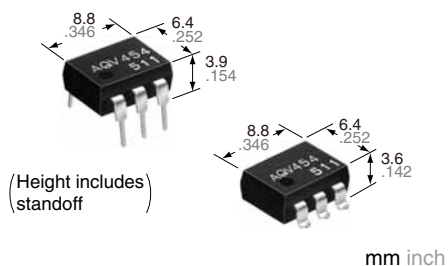

**RoHS compliant**

### FEATURES

#### 1. 1 Form B (Normally-closed) type with low on-resistance

This has been achieved thanks to the built-in MOSFET processed by our proprietary method, DSD (Double-diffused and Selective Doping) method.

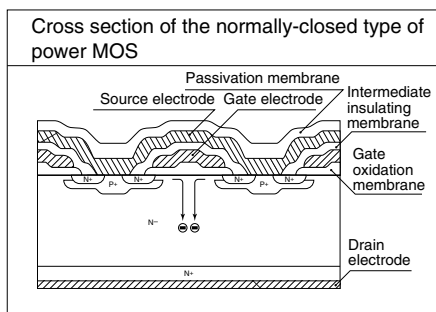

#### 2. Controls low-level analog signals

PhotoMOS feature extremely low closed-circuit offset voltage to enable control of low-level analog signals without distortion.

#### 3. High sensitivity and low on-resistance

Can control max. 0.2 A load current with 5 mA input current. Low on-resistance of typ. 5.5 Ω (AQV453).

#### 4. Reinforced insulation 5,000 V type also available.

More than 0.4 mm .016 inch internal insulation distance between inputs and outputs. Conforms to IEC950 (reinforced insulation).

### TYPICAL APPLICATIONS

- Security equipment
- High-speed inspection machines
- Measuring instruments
- Telephone equipment
- Sensing equipment

### TYPES

	I/O isolation	Output rating*		Package	Part No.				Packing quantity	
		Load voltage	Load current		Through hole terminal	Surface-mount terminal		Tube	Tape and reel	
						Tape and reel packing style				
				Tube packing style		Picked from the 1/2/3-pin side	Picked from the 4/5/6-pin side			
AC/DC dual use	1,500 V AC	250 V	200 mA	DIP6-pin	AQV453	AQV453A	AQV453AX	AQV453AZ	1 tube contains: 50 pcs. 1 batch contains: 500 pcs.	1,000 pcs.
		400 V	150 mA		AQV454	AQV454A	AQV454AX	AQV454AZ		
	Reinforced 5,000 V AC				AQV454H	AQV454HA	AQV454HAX	AQV454HAZ		

\* Indicate the peak AC and DC values.

Note: The surface mount terminal indicator "A" and the packing style indicator "X" or "Z" are not marked on the device.

# HE 1 Form B (AQV450, AQV454H)

## RATING

### 1. Absolute maximum ratings (Ambient temperature: 25°C 77°F)

Item		Symbol	Type of connection	AQV453(A)	AQV454(A)	AQV454H(A)	Remarks
Input	LED forward current	$I_F$		50 mA			$f = 100 \text{ Hz}$ , Duty factor = 0.1%
	LED reverse voltage	$V_R$		5 V			
	Peak forward current	$I_{FP}$		1 A			
	Power dissipation	$P_{in}$		75 mW			
Load voltage (peak AC)		$V_L$		250 V	400 V		
Output	Continuous load current	$I_L$	A	0.2 A	0.15 A		A connection: Peak AC, DC B, C connection: DC
			B	0.3 A	0.18 A		
			C	0.4 A	0.25 A		
	Peak load current	$I_{PEAK}$		0.6 A	0.5 A		A connection: 100 ms (1 shot), $V_L = \text{DC}$
Power dissipation		$P_{OUT}$		360 mW			
Total power dissipation		$P_T$		410 mW			
I/O isolation voltage		$V_{iso}$		1,500 V AC	5,000 V AC		
Temperature limits	Operating	$T_{opr}$		-40°C to +85°C -40°F to +185°F			Non-condensing at low temperatures
	Storage	$T_{stg}$		-40°C to +100°C -40°F to +212°F			

### 2. Electrical characteristics (Ambient temperature: 25°C 77°F)

Item		Symbol	Type of connection	AQV453(A)	AQV454(A)	AQV454H(A)	Remarks	
Input	LED operate (OFF) current	Typical	$I_{Foff}$	—	1 mA	0.9 mA	1.4 mA	$I_L = \text{Max.}$
		Maximum			3 mA			
	LED reverse (ON) current	Minimum	$I_{Fon}$	—	0.4 mA			$I_L = \text{Max.}$
		Typical			0.9 mA	0.8 mA	1.3 mA	
LED dropout voltage	Typical	$V_F$	—	1.25 V (1.14 V at $I_F=5 \text{ mA}$ )			$I_F = 50 \text{ mA}$	
	Maximum			1.5 V				
Output	On resistance	Typical	$R_{on}$	A	5.5 $\Omega$	11 $\Omega$		$I_F = 0 \text{ mA}$ $I_L = \text{Max.}$ Within 1 s on time
		Maximum			8 $\Omega$	16 $\Omega$		
		Typical	$R_{on}$	B	2.7 $\Omega$	6.3 $\Omega$		$I_F = 0 \text{ mA}$ $I_L = \text{Max.}$ Within 1 s on time
		Maximum			4 $\Omega$	8 $\Omega$		
	Typical	$R_{on}$	C	1.4 $\Omega$	3.1 $\Omega$		$I_F = 0 \text{ mA}$ $I_L = \text{Max.}$ Within 1 s on time	
	Maximum			2 $\Omega$	4 $\Omega$			
Off state leakage current	Maximum	$I_{Leak}$	—	1 $\mu\text{A}$	1 $\mu\text{A}$	10 $\mu\text{A}$	$I_F = 5 \text{ mA}$ $V_L = \text{Max.}$	
Transfer characteristics	Operate (OFF) time*	Typical	$T_{off}$	—	1.52 ms	1.2 ms	1.8 ms	$I_F = 0 \text{ mA} \rightarrow 5 \text{ mA}$ $I_L = \text{Max.}$
		Maximum			3 ms	2.0 ms	3.0 ms	
	Reverse (ON) time*	Typical	$T_{on}$	—	0.4 ms	0.36 ms	0.4 ms	$I_F = 5 \text{ mA} \rightarrow 0 \text{ mA}$ $I_L = \text{Max.}$
		Maximum			1 ms			
	I/O capacitance	Typical	$C_{iso}$	—	1.3 pF			$f = 1 \text{ MHz}$ $V_B = 0 \text{ V}$
Maximum	3 pF							
Initial I/O isolation resistance	Minimum	$R_{iso}$	—	1,000 M $\Omega$			500 V DC	

\*Operate/Reverse time

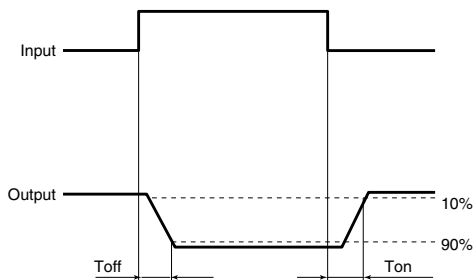

## RECOMMENDED OPERATING CONDITIONS

Please obey the following conditions to ensure proper device operation and resetting.

Item	Symbol	Recommended value	Unit
Input LED current	$I_F$	Standard type: 5 Reinforced insulation type: 5 to 10	mA

■ These products are not designed for automotive use.

If you are considering to use these products for automotive applications, please contact your local Panasonic Corporation technical representative.

# REFERENCE DATA

## 1. Load current vs. ambient temperature characteristics

Allowable ambient temperature: -40°C to +85°C  
-40°F to +185°F

Type of connection: A

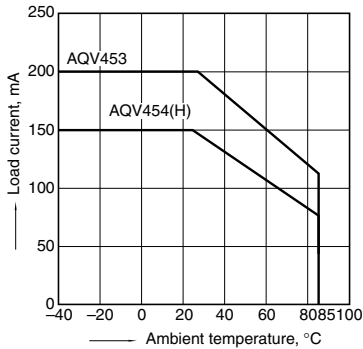

## 2. On resistance vs. ambient temperature characteristics

Measured portion: between terminals 4 and 6;  
LED current: 0 mA; Load voltage: Max. (DC);  
Continuous load current: Max. (DC)

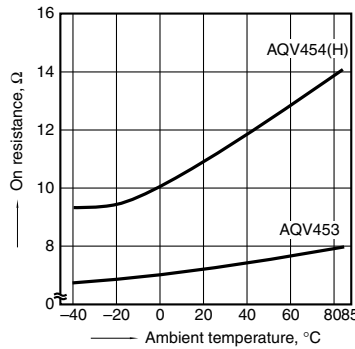

## 3. Operate (OFF) time vs. ambient temperature characteristics

LED current: 5 mA; Load voltage: Max. (DC);  
Continuous load current: Max. (DC)

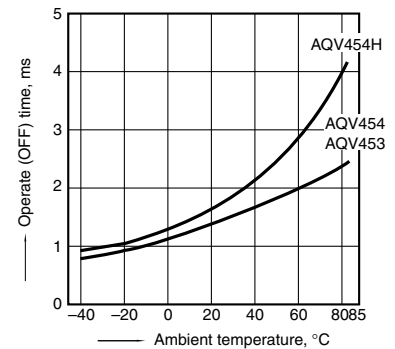

## 4. Reverse (ON) time vs. ambient temperature characteristics

LED current: 5 mA; Load voltage: Max. (DC);  
Continuous load current: Max. (DC)

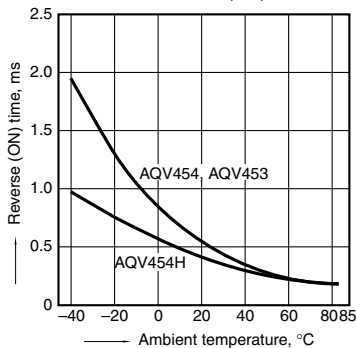

## 5. LED operate (OFF) current vs. ambient temperature characteristics

Load voltage: Max. (DC);  
Continuous load current: Max. (DC)

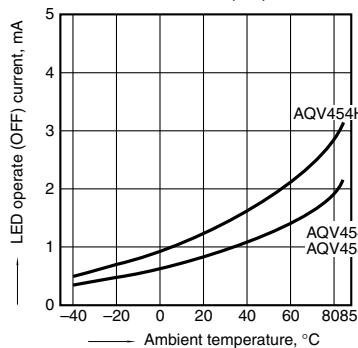

## 6. LED reverse (ON) current vs. ambient temperature characteristics

Load voltage: Max. (DC);  
Continuous load current: Max. (DC)

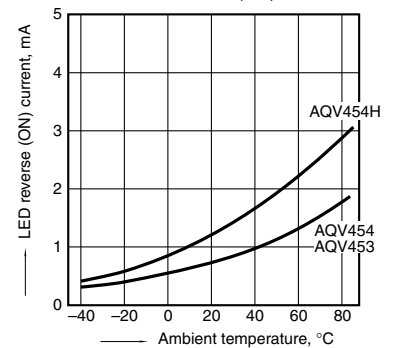

## 7. LED dropout voltage vs. ambient temperature characteristics

LED current: 5 to 50 mA

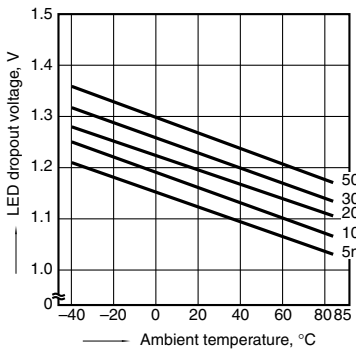

## 8. Current vs. voltage characteristics of output at MOS portion

Measured portion: between terminals 4 and 6;  
Ambient temperature: 25°C 77°F

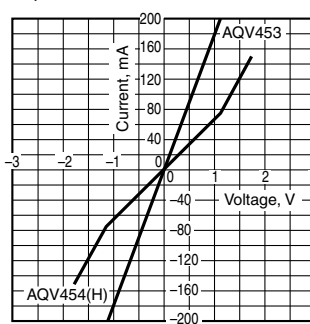

## 9. Off state leakage current vs. load voltage characteristics

Sample: AQV454;  
Measured portion: between terminals 4 and 6;  
Ambient temperature: 25°C 77°F

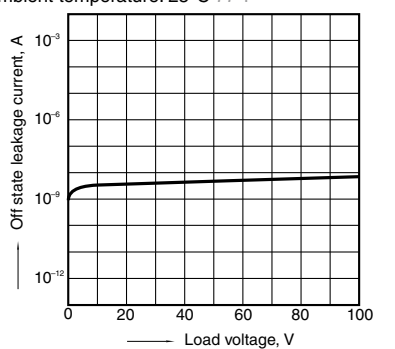

## 10. Operate (OFF) time vs. LED forward current characteristics

Measured portion: between terminals 4 and 6;  
Load voltage: Max. (DC); Continuous load current: Max. (DC); Ambient temperature: 25°C 77°F

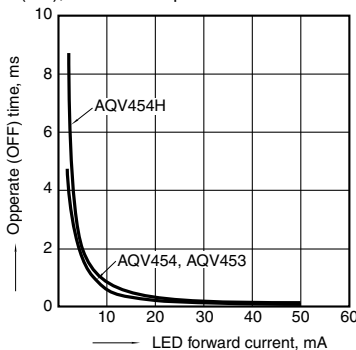

## 11. Reverse (ON) time vs. LED forward current characteristics

Measured portion: between terminals 4 and 6;  
Load voltage: Max. (DC); Continuous load current: Max. (DC); Ambient temperature: 25°C 77°F

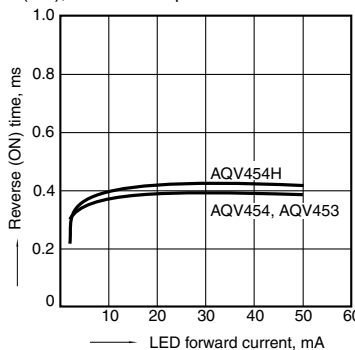

## 12. Output capacitance vs. applied voltage characteristics

Measured portion: between terminals 4 and 6;  
Frequency: 1 MHz; Ambient temperature: 25°C 77°F

