

Panasonic
ideas for life

**GU (General Use)-E Type
[1, 2-Channel (Form A)
4, 6-Pin Type]**

**PhotoMOS
RELAYS**

FEATURES

- 1. Low cost type.**
- 2. Reinforced insulation 5,000V type (DIP type)**
More than 0.4mm internal insulation distance between inputs and outputs. Conforms to EN41003, EN60950 (reinforced insulation)
- 3. Various package design (DIP4, SOP4, DIP8, SOP8 packages are available)**
- 4. High sensitivity, Low ON resistance**
Can control a maximum 0.5A (AQY282EH, AQW282EH) load current with a 5mA input current.
Low ON resistance of 2.5Ω (AQY282EH, AQW282EH).
Stable operation because there are no metallic contact parts.
- 5. Low-level off state leakage current**
The SSR has an off state leakage current of several milliamperes, where as the PhotoMOS relay has only 100pA even with the rated load voltage of 350V (AQY280EH).

TYPICAL APPLICATIONS

- Modem
- Telephone equipment
- Security equipment
- Sensors
- Amusement

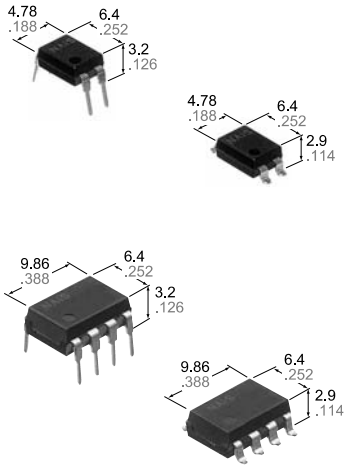

mm inch

DIP TYPES

DIP 4pin

Type	I/O isolation voltage	Output rating*		Part No.				Packing quantity
				Through hole terminal	Surface-mount terminal			
					Tube packing style		Tape and reel packing style	
Load voltage	Load current			Picked from the 1/2-pin side	Picked from the 3/4-pin side			
AC/DC type	Reinforced 5,000 V	60 V	500 mA	AQY282EH	AQY282EHA	AQY282EHAX	AQY282EHAZ	Tube: 1 tube contains 100 pcs. Tube: 1 batch contains 1,000 pcs. Tape and reel: 1,000 pcs.
		350 V	130 mA	AQY280EH	AQY280EHA	AQY280EHAX	AQY280EHAZ	
		400 V	120 mA	AQY284EH	AQY284EHA	AQY284EHAX	AQY284EHAZ	

*Indicate the peak AC and DC values.

Note: For space reasons, the initial letters of the product number "AQY", the SMD terminal shape indicator "A" and the package type indicator "X" and "Z" are omitted from the seal.

DIP 8pin

Type	I/O isolation voltage	Output rating*		Part No.				Packing quantity
				Through hole terminal	Surface-mount terminal			
					Tube packing style		Tape and reel packing style	
Load voltage	Load current			Picked from the 1/2/3/4-pin side	Picked from the 5/6/7/8-pin side			
AC/DC type	Reinforced 5,000 V	60 V	400 mA	AQW282EH	AQW282EHA	AQW282EHAX	AQW282EHAZ	Tube: 1 tube contains 40 pcs. Tube: 1 batch contains 400 pcs. Tape and reel: 1,000 pcs.
		350 V	120 mA	AQW280EH	AQW280EHA	AQW280EHAX	AQW280EHAZ	
		400 V	100 mA	AQW284EH	AQW284EHA	AQW284EHAX	AQW284EHAZ	

*Indicate the peak AC and DC values.

Note: For space reasons, the SMD terminal shape indicator "A" and the package type indicator "X" and "Z" are omitted from the seal.

RATING

1. Absolute maximum ratings (Ambient temperature: 25°C 77°F)

DIP 4pin

Item		Symbol	AQY282EH	AQY280EH	AQY284EH	Remarks
Input	LED forward current	I_F	50 mA			
	LED reverse voltage	V_R	5 V			
	Peak forward current	I_{FP}	1 A			f = 100 Hz, Duty factor = 0.1%
	Power dissipation	P_{in}	75 mW			
Output	Load voltage (peak AC)	V_L	60 V	350 V	400 V	
	Continuous load current (peak AC)	I_L	0.5 A	0.13 A	0.12 A	
	Peak load current	I_{peak}	1.5 A	0.4 A	0.3 A	100 ms (1 shot), $V_L = DC$
	Power dissipation	P_{out}	500 mW			
Total power dissipation		P_T	550 mW			
I/O isolation voltage		V_{iso}	5,000 V AC			
Operating temperature		T_{opr}	-40°C to +85°C -40°F to +185°F			Non-condensing at low temperature
Storage temperature		T_{stg}	-40°C to +100°C -40°F to +212°F			

DIP 8pin

Item		Symbol	AQW282EH	AQW280EH	AQW284EH	Remarks
Input	LED forward current	I_F	50 mA			
	LED reverse voltage	V_R	5 V			
	Peak forward current	I_{FP}	1 A			f = 100 Hz, Duty factor = 0.1%
	Power dissipation	P_{in}	75 mW			
Output	Load voltage (peak AC)	V_L	60 V	350 V	400 V	
	Continuous load current (peak AC)	I_L	0.4 (0.5) A	0.12 (0.14) A	0.1 (0.13) A	(): in case of using only 1 channel
	Peak load current	I_{peak}	1.2 A	0.36 A	0.3 A	100 ms (1 shot), $V_L = DC$
	Power dissipation	P_{out}	800 mW			
Total power dissipation		P_T	850 mW			
I/O isolation voltage		V_{iso}	5,000 V AC			
Operating temperature		T_{opr}	-40°C to +85°C -40°F to +185°F			Non-condensing at low temperature
Storage temperature		T_{stg}	-40°C to +100°C -40°F to +212°F			

2. Electrical characteristics (Ambient temperature: 25°C 77°F)

DIP4pin

Item			Symbol	AQY282EH	AQY280EH	AQY284EH	Condition
Input	LED operate current	Typical	I_{Fon}	1.8 mA			$I_L = Max.$
		Maximum		3.0 mA			
	LED turn off current	Minimum	I_{Foff}	0.2 mA			$I_L = Max.$
		Typical		1.6 mA			
LED dropout voltage	Typical	V_F	1.14 V (1.25 V at $I_F = 50mA$)			$I_F = 5 mA$	
	Maximum		1.5 V				
Output	On resistance	Typical	R_{on}	0.85Ω	20Ω	28Ω	$I_F = 5 mA$ $I_L = Max.$ Within 1 s on time
		Maximum		2.5Ω	25Ω	35Ω	
	Off state leakage current	Maximum	I_{Leak}	1μA			$I_F = 0 mA$ $V_L = Max.$
Transfer characteristics	Turn on time*	Typical	T_{on}	1.8 ms	1.5 ms		$I_F = 5 mA$ $I_L = Max.$
		Maximum		5 ms			
	Turn off time*	Typical	T_{off}	0.5 ms			$I_F = 5 mA$ $I_L = Max.$
		Maximum		2 ms			
	I/O capacitance	Typical	C_{iso}	0.8 pF			f = 1 MHz $V_B = 0V$
Maximum		1.5 pF					
Initial I/O isolation resistance	Minimum	R_{iso}	1,000 MΩ			500 V DC	

AQO280EH

DIP8pin

Item		Symbol	AQW282EH	AQW280EH	AQW284EH	Condition
Input	LED operate current	Typical	1.8 mA			$I_L = \text{Max.}$
		Maximum	3.0 mA			
	LED turn off current	Minimum	0.2 mA			$I_L = \text{Max.}$
		Typical	1.6 mA			
LED dropout voltage	Typical	1.14 V (1.25 V at $I_F = 50\text{mA}$)			$I_F = 5 \text{ mA}$	
	Maximum	1.5 V				
Output	On resistance	Typical	0.85Ω	20Ω	28Ω	$I_F = 5 \text{ mA}$ $I_L = \text{Max.}$ Within 1 s on time
		Maximum	2.5Ω	25Ω	35Ω	
	Off state leakage current	Maximum	1μA			$I_F = 0 \text{ mA}$ $V_L = \text{Max.}$
Transfer characteristics	Turn on time*	Typical	1.8 ms	1.5 ms		$I_F = 5 \text{ mA}$ $I_L = \text{Max.}$
		Maximum	5 ms			
	Turn off time*	Typical	0.5 ms			$I_F = 5 \text{ mA}$ $I_L = \text{Max.}$
		Maximum	2 ms			
	I/O capacitance	Typical	0.8 pF			$f = 1 \text{ MHz}$ $V_B = 0\text{V}$
		Maximum	1.5 pF			
Initial I/O isolation resistance	Minimum	R_{iso}	1,000 MΩ		500 V DC	

*Turn on/Turn off time

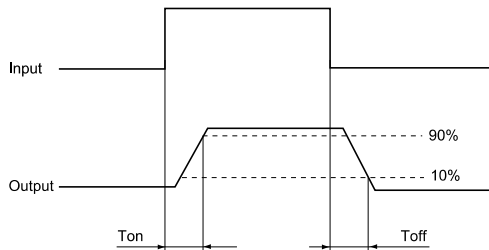

3-4 the terminal leads receive solder plating or solder dip plating.

REFERENCE DATA

[DIP type]

1. Load current vs. ambient temperature characteristics

Allowable ambient temperature: -40°C to +85°C
-40°F to +185°F

Type of connection: A

(1) AQY282EH

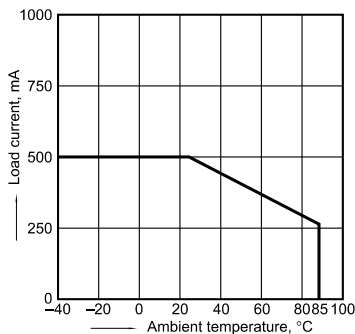

(2) AQY280EH, AQY284EH

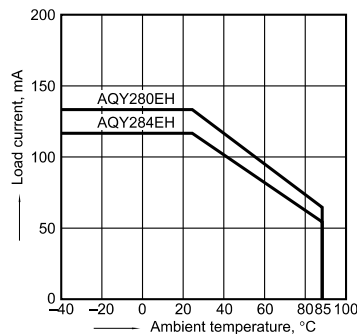

(3) AQW282EH

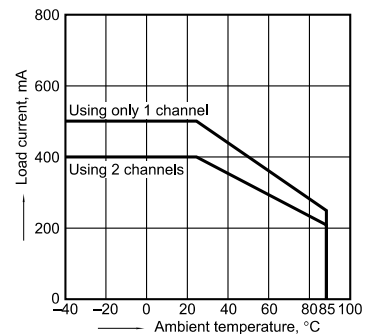

DIMENSIONS

AQY28○S

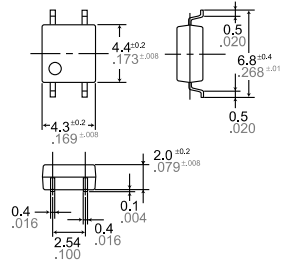

Recommended mounting pad
(Top view)

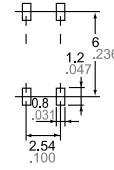

Terminal thickness = 0.15 ± 0.006
General tolerance: $\pm 0.1 \pm 0.004$

Tolerance: $\pm 0.1 \pm 0.004$

AQW28○S

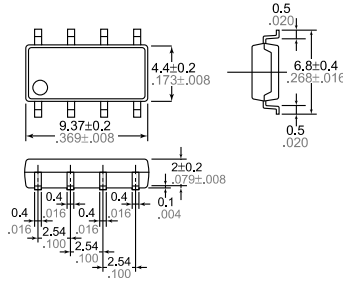

Recommended mounting pad
(Top view)

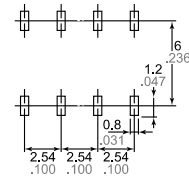

Terminal thickness = 0.15 ± 0.006
General tolerance: $\pm 0.1 \pm 0.004$

Tolerance: $\pm 0.1 \pm 0.004$

AQY28○EH(A)



Through hole terminal type

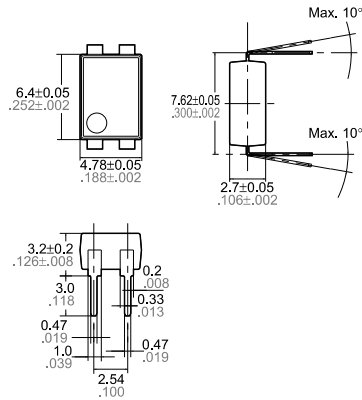

Terminal thickness = 0.2 ± 0.008
General tolerance: $\pm 0.1 \pm 0.004$

Surface mount terminal type

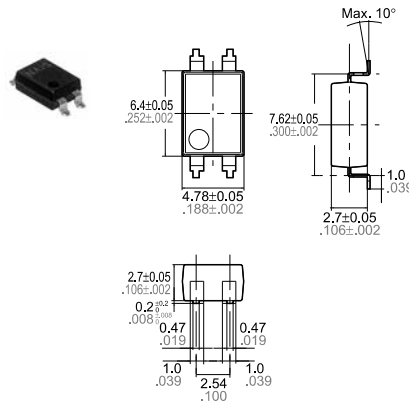

Terminal thickness = 0.2 ± 0.008
General tolerance: $\pm 0.1 \pm 0.004$

PC board pattern (Bottom view)

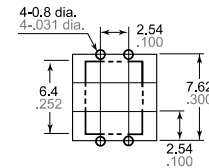

Tolerance: $\pm 0.1 \pm 0.004$

Mounting pad (Top view)

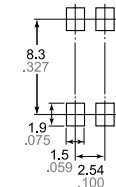

Tolerance: $\pm 0.1 \pm 0.004$

AQW28○EH(A)



Through hole terminal type

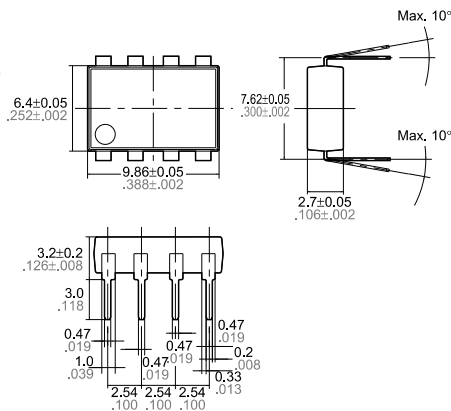

Terminal thickness = 0.2 ± 0.008
General tolerance: $\pm 0.1 \pm 0.004$

Surface mount terminal type

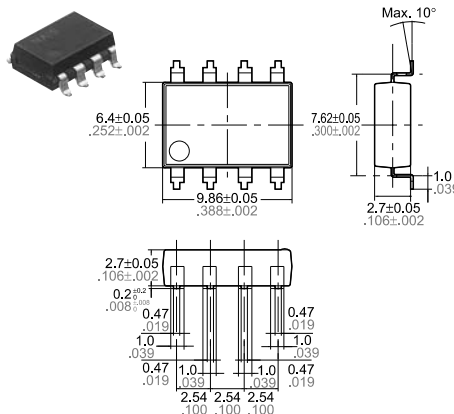

Terminal thickness = 0.2 ± 0.008
General tolerance: $\pm 0.1 \pm 0.004$

PC board pattern
(Bottom view)

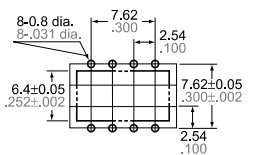

Tolerance: $\pm 0.1 \pm 0.004$

Mounting pad (Top view)

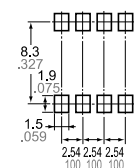

Tolerance: $\pm 0.1 \pm 0.004$