

Metal (Oxide) Film Resistors

Type: **ERG(X)S (Small size)**
(0.5 W, 1 W, 2 W, 3 W, 5 W)
ERG(X)F (Anti-heat conducting for PCB)
(1 W, 2 W, 3 W, 5 W)

■ Features

- Miniaturized
50 % smaller compared to existing models
- Non-flammable
- High Reliability
- Automatic Insertion
- Reference Standards
IEC 60115-2, IEC 60115-4, JIS C 5201-4, EIAJ RC-2138



■ Explanation of Part Numbers

Ex.1 : ERX type

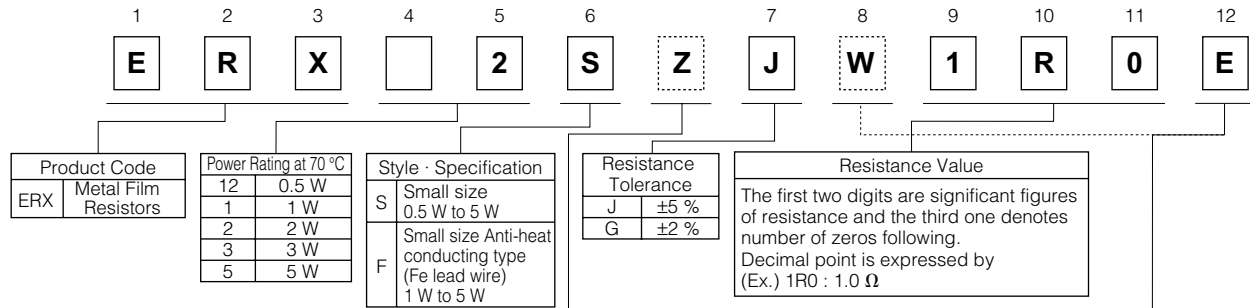

"Z" is added according to resistance.

Type	Resistance Tolerance	Resistance Value Range (Ω)	
		ERX□□SZ	ERX□□S
ERX12S	±5 %	0.10 to 0.18	0.20 to 9.1
	±2 %	0.10 to 0.91	1.0 to 9.1
ERX1S	±5 %	0.10 to 0.18	0.20 to 9.1
	±2 %	0.10 to 0.91	1.0 to 9.1
ERX2S	±5 %	0.10 to 0.20	0.22 to 9.1
	±2 %	0.10 to 0.91	1.0 to 9.1
ERX3S	±5 %	0.10 to 0.20	0.22 to 9.1
	±2 %	0.10 to 0.91	1.0 to 9.1
ERX5S	±5 %	—	0.33 to 9.1
	±2 %	—	1.0 to 9.1

The matrix of forming and packaging is as shown in the table below.

Code	Forming / Packaging	Forming & Taping matrix								
		12S	1S	2S	3S	5S	1F	2F	3F	5F
□··□	Straight lead wire type	○	○	○	○	○	○	○	○	○
□··P	Cut & Forming type	○	○	○	○	○				
□··V	Axial taping type (Straight lead)	○	○	○	○		○	○	○	
U··V	Axial taping type (Stand off)		○	○	○					
□··E	Radial taping type (E type)	○	○	○						
W··E	Radial taping type (WE type)	○	○	○	○					
□··H	Cut & Forming type						○	○	○	○
S··E	Radial taping type (SE type)						○	○	○	

The above example 1 shows a small metal film resistor, 2 W power rating, resistance value of 1.0 Ω, tolerance ±5 %, and package of radial taping.

Ex.2 : ERG type

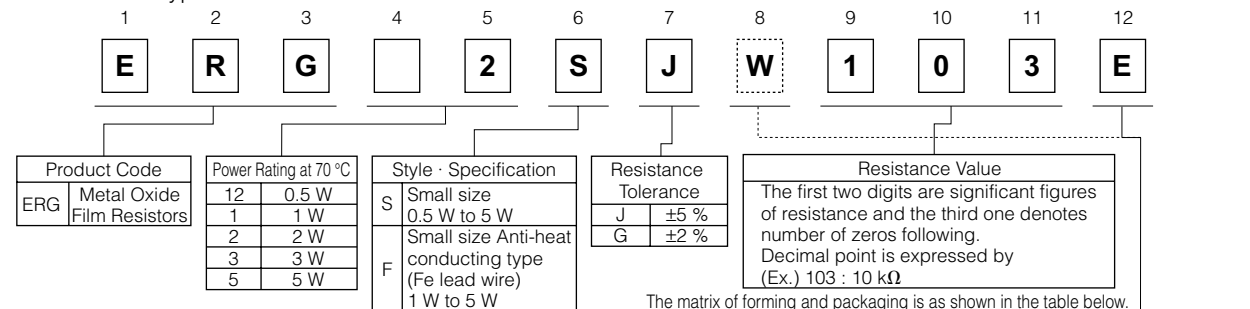

The matrix of forming and packaging is as shown in the table below.

Code	Forming / Packaging	Forming & Taping matrix								
		12S	1S	2S	3S	5S	1F	2F	3F	5F
□··□	Straight lead wire type	○	○	○	○	○	○	○	○	○
□··P	Cut & Forming type	○	○	○	○	○				
□··V	Axial taping type (Straight lead)	○	○	○	○		○	○	○	
U··V	Axial taping type (Stand off)		○	○	○					
□··E	Radial taping type (E type)	○	○	○						
W··E	Radial taping type (WE type)	○	○	○	○					
□··H	Cut & Forming type						○	○	○	○
S··E	Radial taping type (SE type)						○	○	○	

The above example 2 shows a small metal oxide film resistor, 2 W power rating, resistance value of 10 kΩ, tolerance ±5 %, and package of radial taping.

Construction

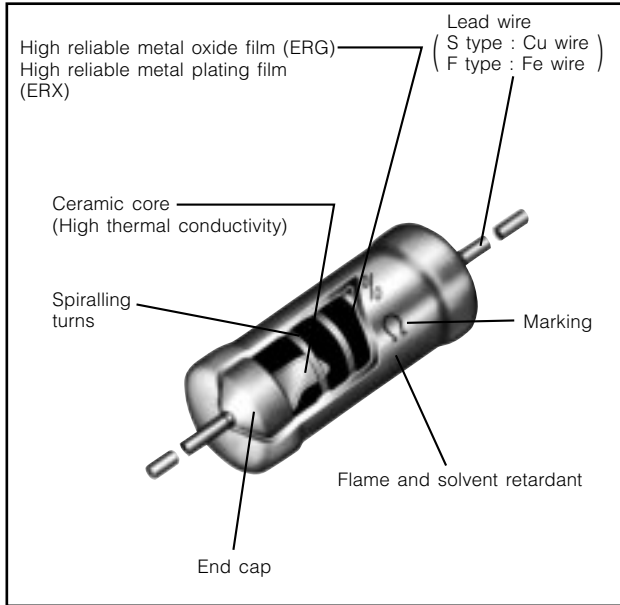

Dimensions in mm (not to scale)

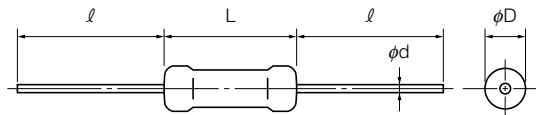

Type	Dimensions (mm)				Mass (Weight) [g/pc.]
	L	ϕD	l	ϕd	
ERG(X)12S	$6.35^{+0.65}_{-0.35}$	$2.3^{+0.5}_{-0.3}$	$30.0^{\pm 3.0}$	$0.65^{\pm 0.05}$	0.26
ERG(X)1S	$9.00^{+1.50}_{-1.00}$	$2.8^{\pm 0.5}$	$30.0^{\pm 3.0}$	$0.65^{\pm 0.05}$	0.33
ERG(X)1F				$0.80^{\pm 0.05}$	
ERG(X)2S	$12.00^{+1.50}_{-1.00}$	$4.0^{\pm 1.0}$	$30.0^{\pm 3.0}$	$0.80^{\pm 0.05}$	0.66
ERG(X)2F					
ERG(X)3S	$15.00^{+1.50}$	$5.5^{\pm 1.0}$	$38.0^{\pm 3.0}$	$0.80^{\pm 0.05}$	1.47
ERG(X)3F					
ERG(X)5S	$24.00^{+1.50}$	$8.0^{\pm 1.0}$	$38.0^{\pm 3.0}$	$0.80^{\pm 0.05}$	3.54
ERG(X)5F					

Ratings

Type	Power Rating at 70 °C (W)	Limiting Element Voltage (Maximum RCWV) ⁽¹⁾ (V)	Maximum Overload Voltage ⁽²⁾ (V)	Maximum Intermittent Overload Voltage ⁽³⁾ (V)	Dielectric Withstanding Voltage (VAC)	Res. Tol. (%) ⁽⁴⁾	Resistance Range (Ω) ⁽⁵⁾		T.C.R. [$\times 10^{-6}/^{\circ}\text{C}$ (ppm/ $^{\circ}\text{C}$)]	Standard Resistance Value
							min. ⁽⁶⁾	max.		
ERG(X)12S	0.5	300	600	600	350	G (± 2)	1	22 k	± 350	E24
						J (± 5)	0.2	47 k		
ERG(X)1S	1	350	600	600	350	G (± 2)	1	68 k	± 350	E24
						J (± 5)	0.2	100 k		
ERG(X)2S	2	350	700	1000	600	G (± 2)	1	100 k	± 350	E24
						J (± 5)	0.22	100 k		
ERG(X)2F						G (± 2)	1	100 k	± 350	E24
						J (± 5)	0.22	100 k		
ERG(X)3S	3	350	700	1000	1000	G (± 2)	1	100 k	± 300	E24
						J (± 5)	0.22	100 k		
ERG(X)3F						G (± 2)	1	100 k	± 300	E24
						J (± 5)	0.22	100 k		
ERG(X)5S	5	500	1000	1500	1000	G (± 2)	1	100 k	± 200	E24
						J (± 5)	0.33	100 k		
ERG(X)5F										

- (1) Rated Continuous Working Voltage (RCWV) shall be determined from $RCWV = \sqrt{\text{Power Rating} \times \text{Resistance Value}}$ or Limiting Element Voltage (max. RCWV) listed above whichever less.
- (2) Overload (Short-time Overload) Test Voltage (SOTV) shall be determined from $SOTV = 2.5 \times \text{Power Rating}$ or max. Overload Voltage listed above whichever less.
- (3) Intermittent Overload Test Voltage (IOTV) shall be determined from $IOTV = 4.0 \times \text{Power Rating}$ or max. Intermittent Overload Voltage listed above whichever less.

- (4) Resistance tolerance is of use besides range listed, please inquire.
- (5) Resistance Range Type ERG : $\geq 10 \Omega$
Type ERX : $\leq 9.1 \Omega$
- (6) As for the low resistance value range, "Z" is given to the part number. (Refer to the explanation of part numbers.)

* Z type is non standard resistance values.

Code	Type	Res. Tol.	Res. Value Range	Code	Type	Res. Tol.	Res. Value Range
Z	12S	$\pm 2\%$	0.1 to 0.91 Ω	Z	2S	$\pm 2\%$	0.1 to 0.91 Ω
		$\pm 5\%$	0.1 to 0.18 Ω		2F	$\pm 5\%$	0.1 to 0.2 Ω
	$\pm 2\%$	0.1 to 0.91 Ω	3S		$\pm 2\%$	0.1 to 0.91 Ω	
	$\pm 5\%$	0.1 to 0.18 Ω	3F		$\pm 5\%$	0.1 to 0.2 Ω	

Power Derating Curve

For resistors operated in ambient temperatures above 70 °C, power rating shall be derated in accordance with the figure on the right.

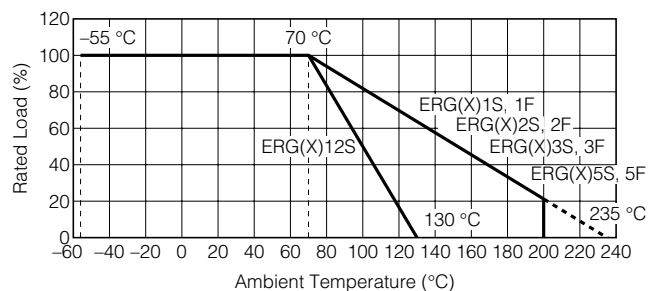

■ Taped & Box:

ERG(X)□□S□□□□V

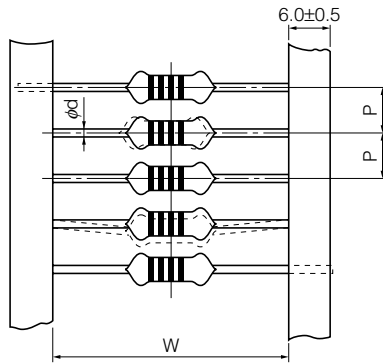

■ Stand-off Taped & Box:

ERG(X)□□S□U□□□V

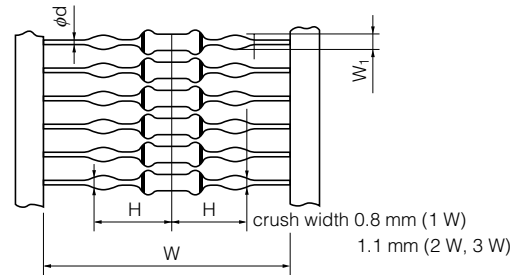

Part Number	Standard Quantity (pcs./box)	Taping (mm)						Box (mm)		
		P	50×P	W	H	W ₁	φd	a	b	c
ERG(X)12S□□□□□V	2000	5.0 ^{+0.3}	250 ^{±2}	52.0 ^{±1.5}	—	—	0.65 ^{+0.05}	85	80	255
ERG(X) 1S□□□□□V	2000	5.0 ^{+0.3}	250 ^{±2}	52.0 ^{±1.5}	—	—	0.65 ^{+0.05}	85	80	255
ERG(X) 1S□U□□□□V					12.0 ^{+0.2}	1.2 ^{+0.15}				
ERG(X) 2S□□□□□V	1000	5.0 ^{+0.3}	250 ^{±2}	52.0 ^{±1.5}	—	—	0.80 ^{+0.05}	85	80	255
ERG(X) 2S□U□□□□V					15.5 ^{+0.2}	1.4 ^{+0.15}				
ERG(X) 3S□□□□□V	1000	10.0 ^{+0.5}	500 ^{±2}	74.0 ^{±2.0}	—	—	0.80 ^{+0.05}	105	100	325
ERG(X) 3S□U□□□□V					23.0 ^{+0.2}	1.4 ^{+0.15}				

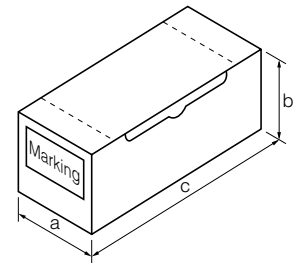

■ Cut & Formed Type

ERG(X)□□S□□□□P

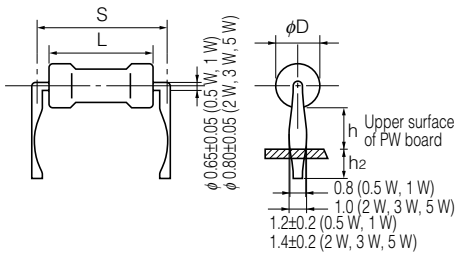

Part Number	Standard Quantity (pcs./box)	Dimensions (mm)				
		L	φD	S	h	h ₂
ERG(X)12S□□□□P	2000	6.35 ^{+0.65} _{-0.35}	2.3 ^{+0.5} _{-0.5}	10.0 ^{±1.5}	4.0 ^{±1.5}	4.0 ^{±1.5}
ERG(X)1S□□□□P	2000	9.00 ^{+1.50} _{-1.00}	2.8 ^{+0.5}	12.5 ^{±1.5}	4.0 ^{±1.5}	4.0 ^{±1.5}
ERG(X)2S□□□□P	1000	12.00 ^{+1.50} _{-1.00}	4.0 ^{±1.0}	15.0 ^{±1.5}	6.0 ^{±1.5}	4.0 ^{±1.5}
ERG(X)3S□□□□P	1000	15.00 ^{+1.50}	5.5 ^{±1.0}	20.0 ^{±2.0}	6.5 ^{±1.5}	4.0 ^{±1.5}
ERG(X)5S□□□□P	500	24.00 ^{+1.50}	8.0 ^{±1.0}	30.0 ^{±2.0}	7.5 ^{±1.5}	4.0 ^{±1.5}

ERG(X)□F□□□□H

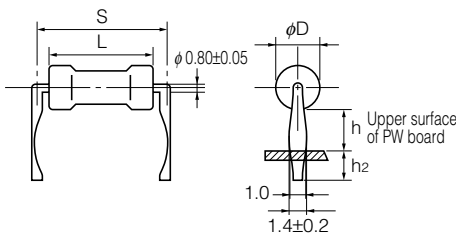

Part Number	Standard Quantity (pcs./box)	Dimensions (mm)				
		L	φD	S	h	h ₂
ERG(X)1F□□□□H	1000	9.0 ^{+1.5} _{-1.0}	2.8 ^{+0.5}	12.5 ^{±1.5}	8 ^{±2}	4.0 ^{±1.5}
ERG(X)2F□□□□H	1000	12.0 ^{+1.5} _{-1.0}	4.0 ^{±1.0}	15.0 ^{±1.5}	6 ^{±2}	5.0 ^{±1.5}
ERG(X)3F□□□□H	1000	15.0 ^{±1.5}	5.5 ^{±1.0}	20.0 ^{±2.0}	10 ^{±2}	5.0 ^{±1.5}
ERG(X)5F□□□□H	500	24.0 ^{+1.5}	8.0 ^{±1.0}	30.0 ^{±2.0}	10 ^{±2}	5.0 ^{±1.5}

■ For Panaset Automatic Insertion Machine Radial Tape & Box

Type ERG(X)□□S□□□□E (12S, 1S, 2S)

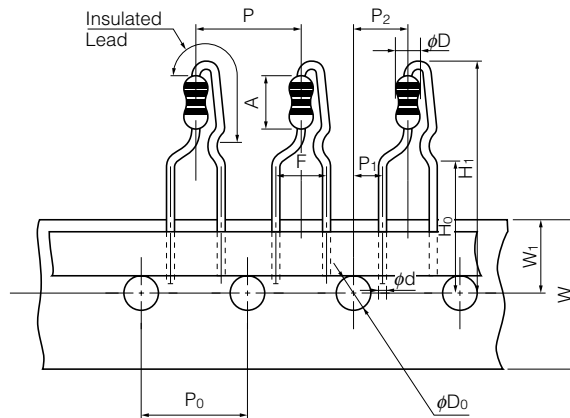

Dimensions (mm)		Dimensions (mm)		Dimensions (mm)		Dimensions (mm)		Dimensions (mm)				
P	12.7±1.0	W	18.0±0.5	H ₁	12S	32 max.	A	12S	6.35 ^{+0.65} _{-0.35}	φD	12S	2.3 ^{+0.5} _{-0.3}
P ₀	12.7±0.3	W ₁	9.0±0.5		1S	32 max.		1S	9.0 ^{+1.5} _{-1.0}		1S	2.8±0.5
P ₁	3.85±0.70				2S	38 max.		2S	12.0 ^{+1.5} _{-1.0}		2S	4.0±1.0
P ₂	6.35±1.00			H ₀	16.0±0.5		φd	0.65±0.05				
F	5.0±0.8			φD ₀	4.0±0.2							

● Radial Tape Package Specifications

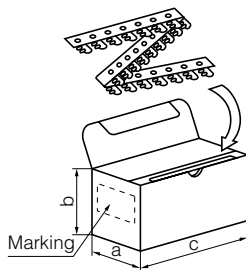

Part Number	Dimensions (mm)			Standard Quantity (pcs./box)
	a	b	c	
ERG(X)12S□□□□E	46	130	335	2000
ERG(X) 1S□□□□E	46	130	335	2000
ERG(X) 2S□□□□E	49	100	335	1000

■ For Panaset Automatic Insertion Machine Radial Taped & Box

Type ERG(X)□□S□W□□□E (12S, 1S, 2S, 3S)

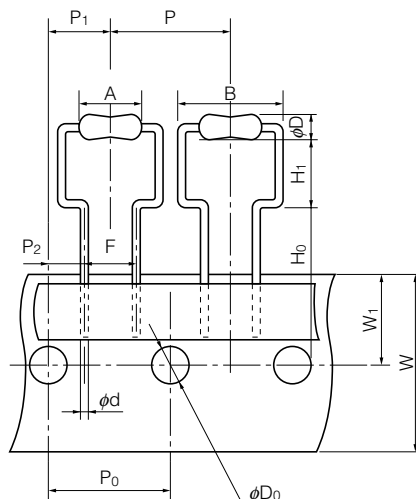

P	Dimensions (mm)		φD ₀	Dimensions (mm)	
	12S	12.7±1.0		12S, 1S, 2S, 3S	4.0±0.2
P ₀	1S, 2S, 3S	30.0±1.0	A	12S	6.35 ^{+0.65} _{-0.35}
	12S	12.7±0.3		1S	9.0 ^{+1.5} _{-1.0}
P ₁	1S, 2S, 3S	15.0±0.3		2S	12.0 ^{+1.5} _{-1.0}
	12S	6.35±1.00		3S	15.0±1.5
P ₂	1S, 2S, 3S	7.5±1.0	B	12S	11.2 max.
	12S	3.85±0.70		1S	14.0 max.
F	1S, 2S, 3S	3.75±0.50		2S	17.0 max.
	12S	5.0±0.5	3S	21.0 max.	
W	1S, 2S, 3S	7.5±0.8	φD	12S	2.3 ^{+0.5} _{-0.3}
	12S, 1S, 2S, 3S	18.0±0.5		1S	2.8±0.5
W ₁	12S, 1S, 2S, 3S	9.0±0.5		2S	4.0±1.0
	12S	16.0±0.5		3S	5.5±1.0
H ₀	1S, 2S	18.0±1.0	φd	12S	φ0.65±0.05
	3S	19.0±1.0		1S, 2S, 3S	φ0.80±0.05
	12S	6.5 ^{+0.6} _{-0.6}			
H ₁	1S, 2S	6.5 ^{+1.0} _{-1.0}			
	3S	8.0 ^{+1.0} _{-1.0}			

■ For Panasert Automatic Insertion Machine Radial Taped & Box

Type ERG(X)□F□S□□□E (1F, 2F, 3F)

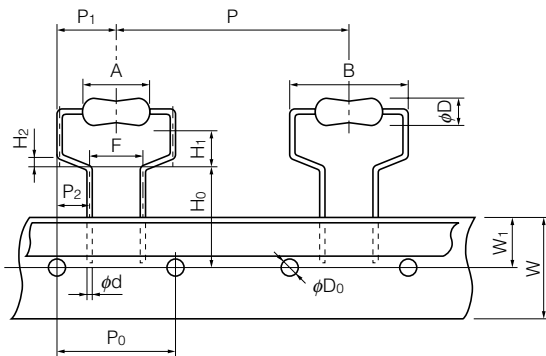

Dimensions (mm)		Dimensions (mm)	
P	30.0±1.0	H ₂	1.0±0.3
P ₀	15.0±0.3	φD ₀	4.0±0.2
P ₁	7.5±1.0	A	1F 9.0 ^{+1.5} _{-1.0}
P ₂	3.75±0.50		2F 12.0 ^{+1.5} _{-1.0}
F	7.5±0.8		3F 15.0±1.5
W	18.0±0.5	B	1F 14 max.
W ₁	9.0±0.5		2F 17 max.
H ₀	16.0 ^{+1.0} ₋₀		3F 21 max.
H ₁	1F	φD	1F 2.8±0.5
	2F		2F 4.0±1.0
	3F		3F 5.5±1.0
		φd	0.80±0.05

● Radial Tape Package Specifications

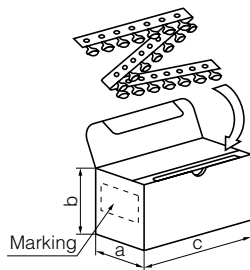

Type	Dimensions (mm)			Standard Quantity (pcs./box)
	a	b	c	
ERG(X)12S□W□□□E	46	145	325	2000
ERG(X) 1S□W□□□E	49	150	317	1000
ERG(X) 1F□S□□□E				
ERG(X) 2S□W□□□E	49	150	317	500
ERG(X) 2F□S□□□E				
ERG(X) 3F□S□□□E	49	190	315	500

Hot-spot Temperature (for Reference)

The temperature of the resistor body increases with the curve below. A touching vinyl wire may cause damages to resistor element. Do not place vinyl wires around resistors and be sure to consider where the resistors will be placed.

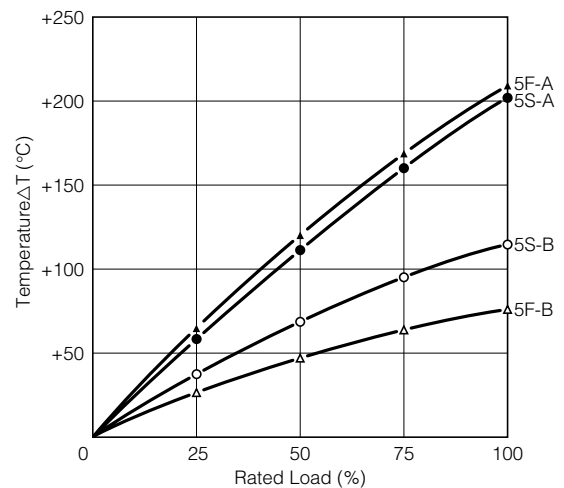
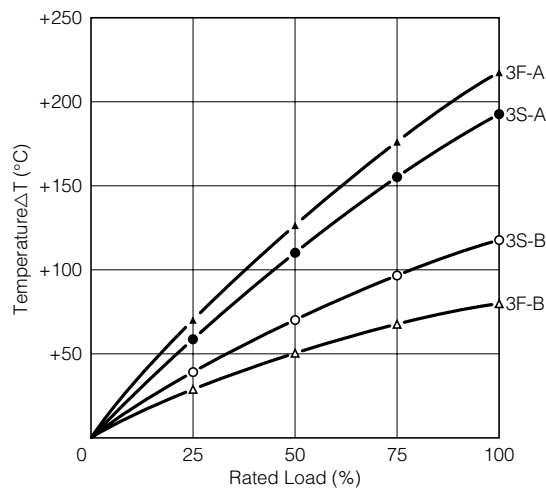
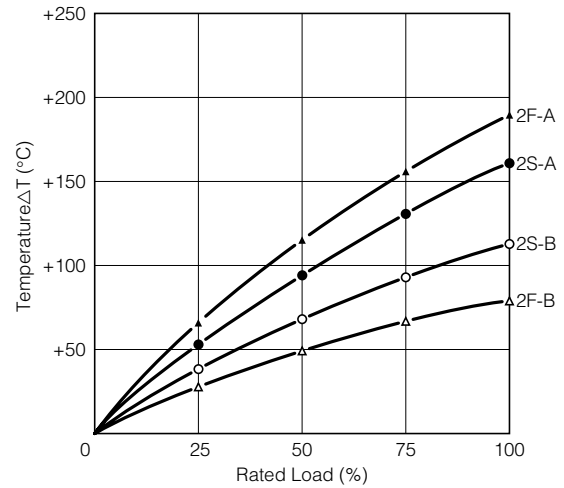
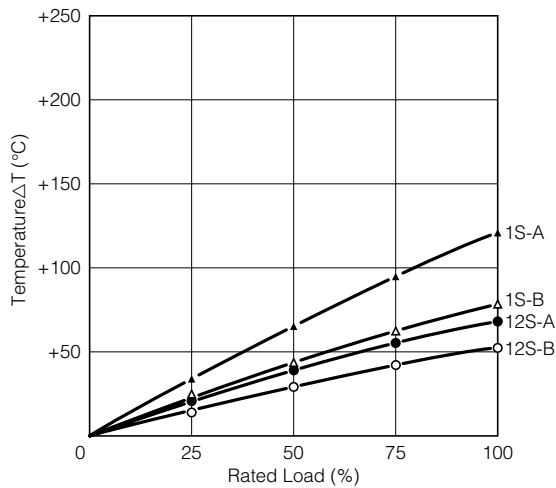
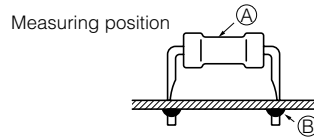

⚠ Safety Precautions

The following are precautions for individual products. Please also refer to the precautions common to Fixed Resistors shown on page ER2 of this catalog.

1. Transient voltage

If there is a possibility that the transient phenomenon (significantly high voltage applied in a short time) may occur or that a high voltage pulse may be applied, make sure to evaluate and check the characteristics of Metal(Oxide) Film Resistors (hereafter called the resistors) mounted on your product rather than only depending on the calculated power limit or steady-state conditions to complete the design or decide to use the resistors.

2. The resistors are covered with a special coating. Do not apply shock or vibration to them, or pinch them with long-nose pliers. Otherwise, the resistors may be damaged.
3. Do not apply excessive tension to the lead-connected sections. When bending the lead wire, do not apply excessive stress to the resistors and provide the wire with a natural curvature.
4. Do not brush the resistors during or after the cleaning process, which may be conducted after soldering. Otherwise, the coating film may be damaged.

(Data for Reference)

■ Pulse Characteristics (Usual)

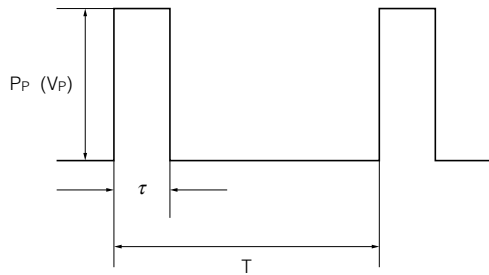

P_P : Pulse limit power (W)
 V_P : Pulse limit voltage (V)
 τ : Pulse continuous time (s)
 T : Period (s)
 V_R : Rated voltage (V)
 P : Rated power (W)
 R : Resistance value (Ω)
 $V_{p\ max.}$: Max. pulse limit voltage (V)

Withstand pulse limit power is calculated by the next method.

$$P_P = K \cdot P \cdot T / \tau$$

$$V_P = \sqrt{K \cdot P \cdot R \cdot T / \tau}$$

Reference to the right about a fixed number of $V_{p\ max.}$

- $T > 1(s) \rightarrow T = 1(s)$
- $T / \tau > 100 \rightarrow T / \tau = 100$
- $P_P < P \rightarrow P$ stands for P_P
($V_P < V_R \rightarrow V_R$ stands for V_P)

- Added voltage $\leq V_{p\ max.}$

- P_P or V_P is referent value

Conditions: Pulse added time = 1000 h

Resistance change = $\pm 5\%$

Room temperature

Type	K	$V_{p\ max.}$ (V)
ERG(X)12S	0.5	600
ERG(X) 1S	0.5	600
ERG(X) 2S	0.5	700
ERG(X) 3S	0.5	700
ERG(X) 5S	0.5	1000

Safety Precautions (Common precautions for Fixed Resistors)

- When using our products, no matter what sort of equipment they might be used for, be sure to make a written agreement on the specifications with us in advance. The design and specifications in this catalog are subject to change without prior notice.
- Do not use the products beyond the specifications described in this catalog.
- This catalog explains the quality and performance of the products as individual components. Before use, check and evaluate their operations when installed in your products.
- Install the following systems for a failsafe design to ensure safety if these products are to be used in equipment where a defect in these products may cause the loss of human life or other significant damage, such as damage to vehicles (automobile, train, vessel), traffic lights, medical equipment, aerospace equipment, electric heating appliances, combustion/gas equipment, rotating equipment, and disaster/crime prevention equipment.
- * Systems equipped with a protection circuit and a protection device
- * Systems equipped with a redundant circuit or other system to prevent an unsafe status in the event of a single fault

(1) Precautions for use

- These products are designed and manufactured for general and standard use in general electronic equipment (e.g. AV equipment, home electric appliances, office equipment, information and communication equipment)
- These products are not intended for use in the following special conditions. Before using the products, carefully check the effects on their quality and performance, and determine whether or not they can be used.
 1. In liquid, such as water, oil, chemicals, or organic solvent
 2. In direct sunlight, outdoors, or in dust
 3. In salty air or air with a high concentration of corrosive gas, such as Cl₂, H₂S, NH₃, SO₂, or NO₂
 4. Electric Static Discharge (ESD) Environment
 - These components are sensitive to static electricity and can be damaged under static shock (ESD). Please take measures to avoid any of these environments.
 - Smaller components are more sensitive to ESD environment.
 5. Electromagnetic Environment
 - Avoid any environment where strong electromagnetic waves exist.
 6. In an environment where these products cause dew condensation
 7. Sealing or coating of these products or a printed circuit board on which these products are mounted, with resin or other materials
- These products generate Joule heat when energized. Carefully position these products so that their heat will not affect the other components.
- Carefully position these products so that their temperatures will not exceed the category temperature range due to the effects of neighboring heat-generating components. Do not mount or place heat-generating components or inflammables, such as vinyl-coated wires, near these products .
- Note that non-cleaning solder, halogen-based highly active flux, or water-soluble flux may deteriorate the performance or reliability of the products.
- Carefully select a flux cleaning agent for use after soldering. An unsuitable agent may deteriorate the performance or reliability. In particular, when using water or a water-soluble cleaning agent, be careful not to leave water residues. Otherwise, the insulation performance may be deteriorated.

(2) Precautions for storage

The performance of these products, including the solderability, is guaranteed for a year from the date of arrival at your company, provided that they remain packed as they were when delivered and stored at a temperature of 5 °C to 35 °C and a relative humidity of 45 % to 85 %.

Even within the above guarantee periods, do not store these products in the following conditions. Otherwise, their electrical performance and/or solderability may be deteriorated, and the packaging materials (e.g. taping materials) may be deformed or deteriorated, resulting in mounting failures.

1. In salty air or in air with a high concentration of corrosive gas, such as Cl₂, H₂S, NH₃, SO₂, or NO₂
2. In direct sunlight

<Package markings>

Package markings include the product number, quantity, and country of origin. In principle, the country of origin should be indicated in English.