

3.5 mm×2.9 mm Side-operational SMD Light Touch Switches

Type: **EVQP7/EVQP3/EVQ9P7**

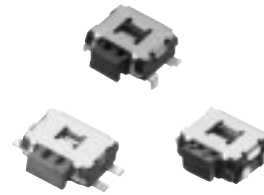

■ Features

- External dimensions : 3.5 mm×2.9 mm, Height 1.35 mm
- A wide range of terminal type : L-shape, J-bent, Straight
- High mount ability

■ Recommended Applications

- Operation switches for portable electronic equipment (Mobile phones, Digital still cameras, Camcorders, Portable audio players, etc.)

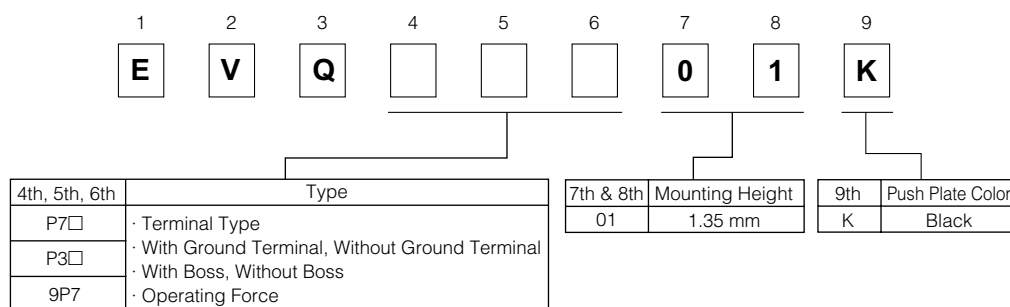

■ Explanation of Part Numbers



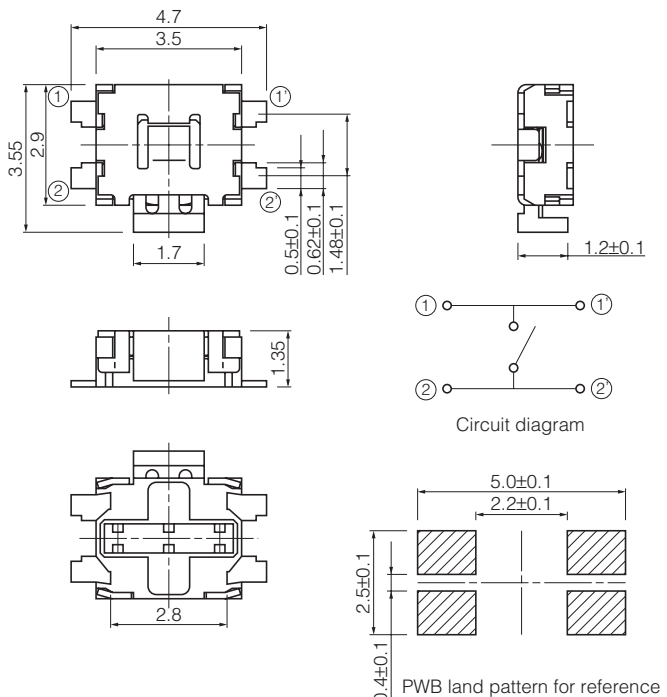

■ Specifications

Type	Snap action / Push-on type SPST	
Electrical	Rating	10 μ A 2 Vdc to 50 mA 12 Vdc (Resistive load)
	Contact Resistance	100 m Ω max.
	Insulation Resistance	100 M Ω min. (at 100 Vdc)
	Dielectric Withstanding Voltage	250 Vac (1 minute)
	Bouncing	10 ms max. (ON, OFF)
Mechanical	Operating Force	1.6 N, 2.2 N
	Push Travel	0.2 mm
	Push Strength	30 N (1 minute)
Endurance	Operating Life	100000 cycles min.
Operating Temperature		-40 °C to +85 °C
Storage Temperature		-40 °C to +85 °C (Bulk) -20 °C to +60 °C (Taping)
Minimum Quantity/Packing Unit		5000 pcs. Embossed Taping (Reel Pack)
Quantity/Carton		25000 pcs.

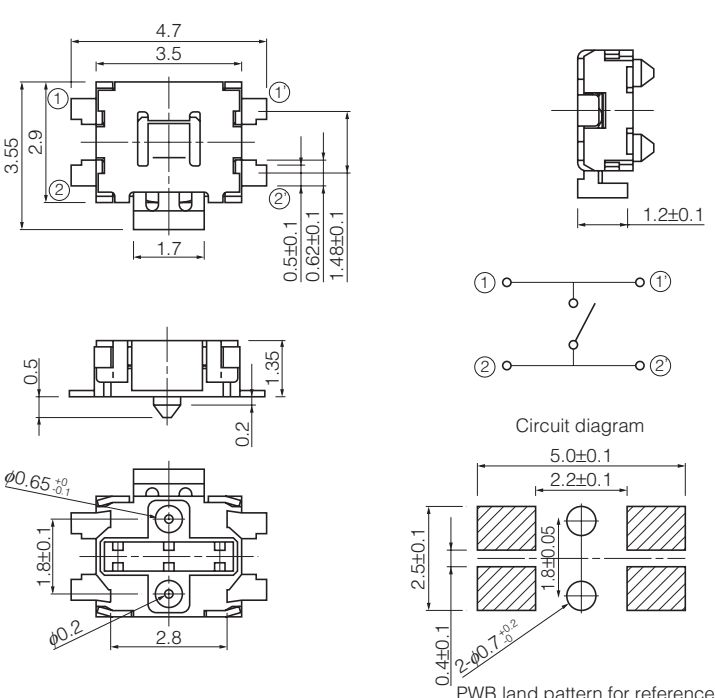
■ Dimensions in mm (not to scale)

<p>No. 1</p> <p>EVQP7A EVQP7J</p> <p>(Embossed Taping)</p> <p>With straight terminals Without boss</p> 				
<p>Part Numbers</p>	<p>Operating Force</p>	<p>Height</p>	<p>Push Plate Color</p>	<p>Operating Life</p>
<p>EVQP7A01K</p>	<p>2.2 N</p>	<p>1.35 mm</p>	<p>Black</p>	<p>100000 cycles</p>
<p>EVQP7J01K</p>	<p>1.6 N</p>	<p>1.35 mm</p>	<p>Black</p>	<p>100000 cycles</p>
<p>No. 2</p> <p>EVQP7C EVQP7L</p> <p>(Embossed Taping)</p> <p>With straight terminals With boss</p> 				
<p>Part Numbers</p>	<p>Operating Force</p>	<p>Height</p>	<p>Push Plate Color</p>	<p>Operating Life</p>
<p>EVQP7C01K</p>	<p>2.2 N</p>	<p>1.35 mm</p>	<p>Black</p>	<p>100000 cycles</p>
<p>EVQP7L01K</p>	<p>1.6 N</p>	<p>1.35 mm</p>	<p>Black</p>	<p>100000 cycles</p>

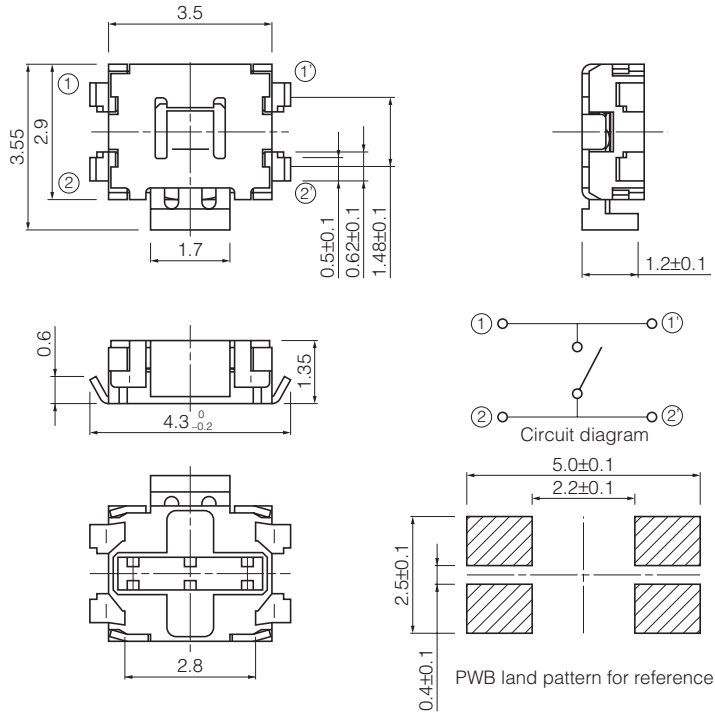
■ Dimensions in mm (not to scale)

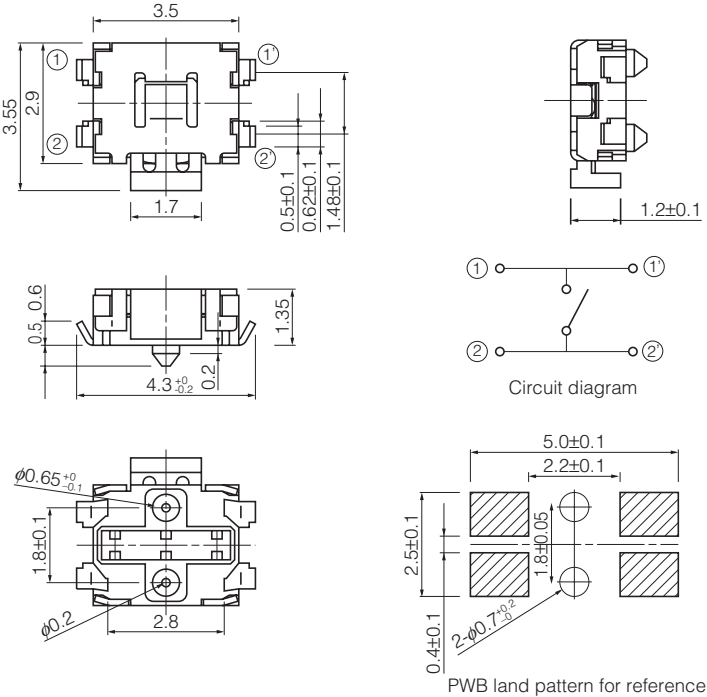
<p>No. 3</p> <p>EVQP7B EVQP7K</p> <p>(Embossed Taping)</p> <p>With J-bent terminals Without boss</p> 				
<p>Part Numbers</p>	<p>Operating Force</p>	<p>Height</p>	<p>Push Plate Color</p>	<p>Operating Life</p>
<p>EVQP7B01K</p>	<p>2.2 N</p>	<p>1.35 mm</p>	<p>Black</p>	<p>100000 cycles</p>
<p>EVQP7K01K</p>	<p>1.6 N</p>	<p>1.35 mm</p>	<p>Black</p>	<p>100000 cycles</p>
<p>No. 4</p> <p>EVQP7D EVQP7M</p> <p>(Embossed Taping)</p> <p>With J-bent terminals With boss</p> 				
<p>Part Numbers</p>	<p>Operating Force</p>	<p>Height</p>	<p>Push Plate Color</p>	<p>Operating Life</p>
<p>EVQP7D01K</p>	<p>2.2 N</p>	<p>1.35 mm</p>	<p>Black</p>	<p>100000 cycles</p>
<p>EVQP7M01K</p>	<p>1.6 N</p>	<p>1.35 mm</p>	<p>Black</p>	<p>100000 cycles</p>

■ Dimensions in mm (not to scale)

No. 5 EVQP3 EVQ9P (Embossed Taping) With L-shape terminals Without boss				
Part Numbers	Operating Force	Height	Push Plate Color	Operating Life
EVQP3401K	2.2 N	1.35 mm	Black	100000 cycles
EVQ9P701K	1.6 N	1.35 mm	Black	100000 cycles

■ Recommended Reflow Soldering Conditions

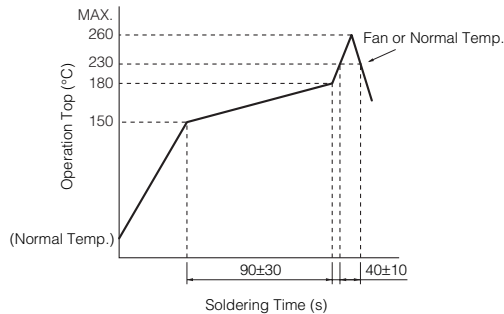

● Embossed Carrier Taping

Tape width=12.0 mm

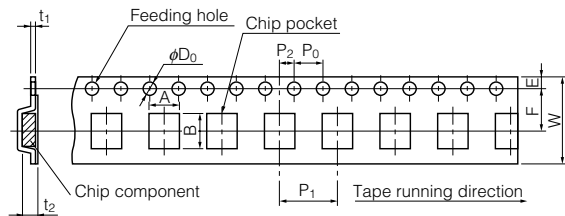

● Straight terminals type

Unit: mm

Part No.	Height	A	B	W	F	E	P ₁	P ₂	P ₀	D ₀ Dia.	t ₁	t ₂
EVQP7, EVQP3	1.35	5.2±0.2	4.5±0.2	12.0±0.3	5.5±0.1	1.75±0.10	8.0±0.1	2.0±0.1	4.0±0.1	1.5 ^{+0.1} ₋₀	0.3±0.1	1.5±0.2

● J-bent, L-shape terminals type

Unit: mm

Part No.	Height	A	B	W	F	E	P ₁	P ₂	P ₀	D ₀ Dia.	t ₁	t ₂
EVQP7, EVQP3 EVQ9P7	1.35	4.5±0.2	4.5±0.2	12.0±0.3	5.5±0.1	1.75±0.10	8.0±0.1	2.0±0.1	4.0±0.1	1.5 ^{+0.1} ₋₀	0.3±0.1	1.5±0.2

● Standard Reel Dimensions in mm (not to scale)

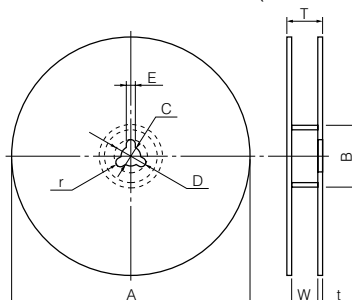

Item	A	B	C	D	E
Rate (mm)	φ380.0±2.0	φ80.0 min.	φ13.0±0.5	φ21.0±1.0	2.0±0.5
Item	W	T	t	r	
Rate (mm)	13.5±1.0	17.5±1.0	1.0 to 3.0	1.0±0.5	