

Chip Inductors

Japan

Series: **Chip**
Type: **F, E,
D, C, A, B**



Non wound and wire wound type chip inductors for automatic and high-density mounting

Industrial Property : Patents 6 (pending)

■ Features

- High Q
- Good for mounting
- Wide availability range (1.0 nH to 1000 μH)
- Stable L -value in any mounting direction(Non winding type)

■ Recommended Applications

- Portable telephones, Wireless Communication equipment (W-LAN, BT), PDA, Camcorder, DSC, Various module, HIC, TV, VTR, PC peripherals.

■ Explanation of Part Numbers

Example of Part Number Build:

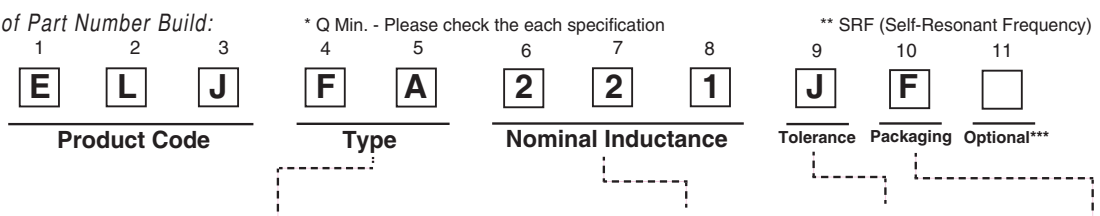

Item	Laser-Cut		Wire Wound Types			
	F 1005 (0402)	E 1608 (0603)	D 2012 (0805)	C 2520 (1008)	A 3225 (1210)	B 4532 (1812)
Types						
Non Magnetic Core	RF	RE	ND	NC	NA	-
NonMagneticCore(HighQ)	QF	-	-	-	-	-
General Use	-	-	-	FC	FA	FB
Magnetic Shield	-	-	-	-	SA	-
High Current	PF	PE	-	PC	PA	PB
High Current, very low DCR	-	-	-	-	EA	-

Code	Value
2N2	--> 2.2 nH
22N	--> 22 nH
R22	--> 0.22 μH
2R2	--> 2.2 μH
220	--> 22 μH
221	--> 220 μH
102	--> 1000 μH

Code	Value
Z:	± 0.2 nH
D:	± 0.3 nH
E:	± 0.5 nH
G:	± 2 %
A:	± 3 %
J:	± 5 %
K:	± 10 %
M:	± 20 %

F Tape & Reel

***Note: Part Number position #11 is an optional factory designation.

Size unit: mm (inch)

■ Inductance, Size Guide

● High Frequency Equipment

Item	Size	Type	L VALUE							
			0.001	0.01	0.1	1.0	10	100	(μ H) 1000	
Laser Cut	1005 (0402) RF	Non Magnetic Core	D,Z J,Z J,G							Tolerance Z : \pm 0.2 nH D : \pm 0.3 nH E : \pm 0.5 nH G : \pm 2 % J : \pm 5 % K : \pm 10 % M : \pm 20 %
	1005 (0402) QF	Non Magnetic Core High-Q	D,Z J,Z J,G							
	1005 (0402) PF	High power	D,J							
	1608 (0603) RE	Non Magnetic Core	D,Z J,Z J,G							
	1608 (0603) PE	High power	K							

● General Equipment

Item	Size	Type	L VALUE							
			0.001	0.01	0.1	1.0	10	100	(μ H) 1000	
Wire wound type	2012 (0805) ND	Non Magnetic Core		K J,K						
	2520 (1008) NC	Non Magnetic Core		K J,K						
	2520 (1008) FC	General Use			K,M J,K					
	2520 (1008) PC	High power			M K					
	3225 (1210) NA	Non Magnetic Core			M K J					
	3225 (1210) FA	General Use			K,M J,K					
	3225 (1210) SA	Shield	Tolerance D : \pm 0.3 nH E : \pm 0.5 nH G : \pm 2 % A : \pm 3 % J : \pm 5 % K : \pm 10 % M : \pm 20 %		K					
	3225 (1210) PA	High power			M K					
	3225 (1210) EA	Low DC resistance			M K					
	4532 (1812) FB	General Use			M K,M J,K					
	4532 (1812) PB	High power			K					

Size : mm (inch)

1. Non Magnetic Core Types RF, RE, ND, NC, NA

■ Type 1005(0402)RF

● Dimensions in mm (not to scale)

● Recommended Land Pattern in mm (not to scale)



■ Standard Packing Quantity

● 10000 pcs./Reel

■ Examples

Part No.*3	Inductance		Q min.	L,Q Test Freq. (MHz)	SRF*1 (MHz)min.	DCR*2 (Ω)max.	DC Current (mA)max.
	(nH)	Tolerance					
ELJRF1N0D/ZF2	1.0	±0.3 nH	8	100	6000	0.05	400
ELJRF1N2D/ZF2	1.2				6000	0.06	400
ELJRF1N5D/ZF2	1.5				6000	0.07	400
ELJRF1N8D/ZF2	1.8				6000	0.08	400
ELJRF2N2D/ZF2	2.2				6000	0.09	400
ELJRF2N7D/ZF2	2.7				5500	0.10	400
ELJRF3N3D/ZF2	3.3				5500	0.12	400
ELJRF3N9D/ZF2	3.9				5200	0.15	360
ELJRF4N7D/ZF2	4.7				4800	0.17	360
ELJRF5N6D/ZF2	5.6				4600	0.19	340
ELJRF6N8J/ZF2	6.8	± 5 %	8	100	4000	0.30	320
ELJRF8N2J/ZF2	8.2				3500	0.35	320
ELJRF10NJ/GF2	10.0				2800	0.41	320
ELJRF12NJ/GF2	12.0				2800	0.45	320
ELJRF15NJ/GF2	15.0				2500	0.60	240
ELJRF18NJ/GF2	18.0				2200	0.70	240
ELJRF22NJ/GF2	22.0				2000	0.80	200
ELJRF27NJ/GF2	27.0				1800	1.20	200
ELJRF33NJ/GF2	33.0				1800	1.40	170
ELJRF39NJ/GF2	39.0				1800	1.70	150
ELJRF47NJ/GF2	47.0	1800	2.10	140			
ELJRF56NJ/GF2	56.0	1500	2.50	130			
ELJRF68NJ/GF2	68.0	1500	4.00	120			
ELJRF82NJ/GF2	82.0	1400	4.50	110			
ELJRF10J/GF2	100.0	1200	5.50	90			
ELJRF3N6D/ZF2	3.6	±0.3 nH	8	100	5300	0.14	380
ELJRF4N3D/ZF2	4.3				5000	0.16	360
ELJRF5N1D/ZF2	5.1				4700	0.18	350
ELJRF6N2D/ZF2	6.2				4300	0.25	330
ELJRF7N5J/ZF2	7.5				3700	0.33	320
ELJRF9N1J/ZF2	9.1				3100	0.38	320
ELJRF11NJ/GF2	11.0				2800	0.43	320
ELJRF13NJ/GF2	13.0				2600	0.53	280
ELJRF16NJ/GF2	16.0				2300	0.65	240
ELJRF20NJ/GF2	20.0				2100	0.75	220
ELJRF24NJ/GF2	24.0	1900	1.00	200			
ELJRF30NJ/GF2	30.0	1800	1.30	190			
ELJRF36NJ/GF2	36.0	1800	1.60	160			
ELJRF43NJ/GF2	43.0	1800	1.90	150			

*1 : Self Resonant Frequency *2 : DC Resistance *3 Lead-Free P/Ns have an "FB" suffix, rather than 'F2'

Design and specifications are subject to change without notice. Ask factory for technical specifications before purchase and/or use. Whenever a doubt about safety arises from this product, please contact us immediately for technical consultation.

■ Type 1608(0603)RE

● Dimensions in mm (not to scale)



● Recommended Land Pattern in mm (not to scale)



■ Standard Packing Quantity

● 3000 pcs./Reel

■ Examples

Part No. *3	Inductance		Q min.	L, Q Test Freq. (MHz)	SRF *1 (MHz)min.	DCR *2 (Ω)max.	DC Current (mA)max.	
	(nH)	Tolerance						
ELJRE1N0D/ZF2	1.0	±0.3 nH	7	100	6000	0.05	500	
ELJRE1N2D/ZF2	1.2				6000	0.06	500	
ELJRE1N5D/ZF2	1.5		±0.2 nH		8	6000	0.07	500
ELJRE1N8D/ZF2	1.8					6000	0.08	500
ELJRE2N2D/ZF2	2.2				6000	0.09	500	
ELJRE2N7D/ZF2	2.7				6000	0.10	500	
ELJRE3N3D/ZF2	3.3	±5 %	9		5500	0.12	500	
ELJRE3N9J/ZF2	3.9				5500	0.15	450	
ELJRE4N7J/ZF2	4.7		±2 %		10	4800	0.17	450
ELJRE5N6J/ZF2	5.6					4600	0.18	430
ELJRE6N8J/ZF2	6.8				3550	0.20	430	
ELJRE8N2J/ZF2	8.2				3500	0.28	400	
ELJRE10NJ/GF2	10.0	±5 %	10	2800	0.32	400		
ELJRE12NJ/GF2	12.0			2800	0.35	400		
ELJRE15NJ/GF2	15.0		±2 %	11	2500	0.41	350	
ELJRE18NJ/GF2	18.0				2300	0.45	350	
ELJRE22NJ/GF2	22.0			2000	0.50	300		
ELJRE27NJ/GF2	27.0			2000	0.55	300		
ELJRE33NJ/GF2	33.0	±5 %	11	1800	0.60	300		
ELJRE39NJ/GF2	39.0			1800	0.80	300		
ELJRE47NJ/GF2	47.0		±2 %	12	1800	0.95	250	
ELJRE56NJ/GF3	56.0				1800	1.20	250	
ELJRE68NJ/GF3	68.0			1500	1.30	250		
ELJRE82NJ/GF3	82.0			1500	1.50	250		
ELJRER10J/GF3	100.0	±5 %	5	1300	1.80	200		
ELJRER12J/GF3	120.0			1200	3.00	130		
ELJRER15J/GF3	150.0		±2 %	4	1100	4.50	100	
ELJRER18J/GF3	180.0				1000	6.50	80	
ELJRER22J/GF3	220.0			900	7.50	70		
ELJRE3N6D/ZF2	3.6			±0.3 nH	9	100	5500	0.14
ELJRE4N3J/ZF2	4.3	±0.2 nH	5100	0.16			450	
ELJRE5N1J/ZF2	5.1		4700	0.18			450	
ELJRE6N2J/ZF2	6.2		4000	0.19			450	
ELJRE7N5J/ZF2	7.5		3500	0.24			430	
ELJRE9N1J/ZF2	9.1	±5 %	10	3100			0.30	430
ELJRE11NJ/GF2	11.0			2800	0.33		400	
ELJRE13NJ/GF2	13.0		±2 %	2600	0.38		400	
ELJRE16NJ/GF2	16.0			2400	0.43		400	
ELJRE20NJ/GF2	20.0			2100	0.48		350	
ELJRE24NJ/GF2	24.0			2000	0.53		300	
ELJRE30NJ/GF2	30.0	±5 %	10	1900	0.58		300	
ELJRE36NJ/GF2	36.0			1800	0.70	300		
ELJRE43NJ/GF2	43.0			1800	0.87	300		

*1 : Self Resonant Frequency *2 : DC Resistance *3 Lead-Free P/Ns have an "FA" suffix rather than 'F2' or 'F3'

Design and specifications are subject to change without notice. Ask factory for technical specifications before purchase and/or use. Whenever a doubt about safety arises from this product, please contact us immediately for technical consultation.

■ Type 2012(0805)ND

● Dimensions in mm (not to scale)



● Recommended Land Pattern in mm (not to scale)

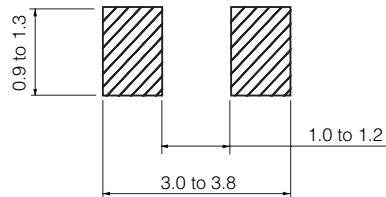

■ Standard Packing Quantity

- 3000 pcs./Reel

■ Examples

Part No.	Inductance		Q min.	L, Q Test Freq. (MHz)	Q Typical (800 MHz)	SRF *1 (MHz)min.	DCR *2 (Ω)max.	DC Current (mA)max.	
	(nH)	Tolerance							
ELJND10NKF	10	± 10 %	10	100	72	3300	0.18	540	
ELJND12NKF	12				12	67	3300	0.24	535
ELJND15NKF	15					73	3000	0.24	520
ELJND18NKF	18		15		12	74	3000	0.29	480
ELJND22NKF	22					75	2600	0.29	465
ELJND27NKF	27				73	2500	0.34	455	
ELJND33NJ/KF	33	± 5 %			15	80	2050	0.39	395
ELJND39NJ/KF	39					72	2000	0.41	390
ELJND47NJ/KF	47					71	1650	0.46	385
ELJND56NJ/KF	56		63			1550	0.51	360	
ELJND68NJ/KF	68		57			1450	0.57	340	
ELJND82NJ/KF	82		56			1100	0.63	330	
ELJNDR10J/KF	100	± 10 %	8	25.2	51	800	0.86	285	
ELJNDR12J/KF	120				10	32	600	0.99	275
ELJNDR15J/KF	150					36	600	1.47	230
ELJNDR18J/KF	180		10		10	34	600	1.61	195
ELJNDR22J/KF	220					—	500	1.84	170
ELJNDR27J/KF	270					—	300	1.95	165
ELJNDR33J/KF	330					—	200	2.16	160
ELJNDR39J/KF	390					—	150	2.37	150
ELJNDR47J/KF	470					—	150	2.56	145
ELJNDR56J/KF	560		8		8	—	100	2.69	140
ELJNDR68J/KF	680					—	100	3.02	130
ELJNDR82J/KF	820					—	80	3.38	125
ELJND1R0J/KF	1000	—		80		3.88	120		

*1 : Self Resonant Frequency *2 : DC Resistance

Design and specifications are subject to change without notice. Ask factory for technical specifications before purchase and/or use. Whenever a doubt about safety arises from this product, please contact us immediately for technical consultation.

■ Type 2520(1008)NC

● Dimensions in mm (not to scale)



● Recommended Land Pattern in mm (not to scale)

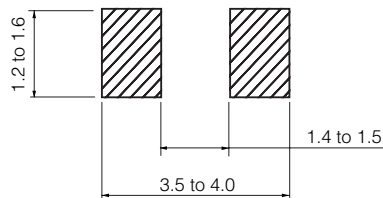

■ Standard Packing Quantity

- 2000 pcs./Reel

■ Examples

Part No.	Inductance		Q min.	L, Q Test Freq. (MHz)	SRF *1 (MHz)min.	DCR *2 (Ω)max.	DC Current (mA)max.
	(nH)	Tolerance					
ELJNC10NKF	10	±10 %	10	100	2500	0.32	280
ELJNC12NKF	12				2200	0.34	270
ELJNC15NKF	15				1800	0.38	255
ELJNC18NKF	18				1550	0.40	250
ELJNC22NKF	22				1350	0.43	240
ELJNC27NKF	27				1150	0.47	230
ELJNC33NK/JF	33	±10 %	15	100	1000	0.51	220
ELJNC39NK/JF	39				890	0.55	215
ELJNC47NK/JF	47				770	0.59	205
ELJNC56NK/JF	56				670	0.63	200
ELJNC68NK/JF	68				590	0.68	190
ELJNC82NK/JF	82				520	0.73	185
ELJNCR10K/JF	100	±10 % ±5 %	10	25.2	460	0.80	175
ELJNCR12K/JF	120				400	0.87	170
ELJNCR15K/JF	150				340	0.98	160
ELJNCR18K/JF	180				300	1.05	155
ELJNCR22K/JF	220				260	1.15	145
ELJNCR27K/JF	270				230	1.25	140
ELJNCR33K/JF	330				200	1.37	135
ELJNCR39K/JF	390				180	1.47	130
ELJNCR47K/JF	470				160	1.58	125
ELJNCR56K/JF	560				145	1.70	120
ELJNCR68K/JF	680	130	1.85	110			
ELJNCR82K/JF	820	100	2.10	100			

*1 : Self Resonant Frequency *2 : DC Resistance

Design and specifications are subject to change without notice. Ask factory for technical specifications before purchase and/or use.
Whenever a doubt about safety arises from this product, please contact us immediately for technical consultation.

■ Type 3225(1210)NA

● Dimensions in mm (not to scale)



● Recommended Land Pattern in mm (not to scale)



■ Standard Packing Quantity

- 2000 pcs./Reel

■ Examples

Part No.	Inductance			Q		SRF *1 (MHz)min.	DCR *2 (Ω)max.	DC Current (mA)max.
	(μH)	Freq. (MHz)	Tolerance	min.	Freq. (MHz)			
ELJNA47NMF	0.047	100	±20 %	10	100	680	0.20	450
ELJNA56NMF	0.056					600	0.22	420
ELJNA68NMF	0.068					540	0.25	400
ELJNA82NMF	0.082					500	0.27	380
ELJNAR10MF	0.100					450	0.30	360
ELJNAR12MF	0.120	25.2	±10 %	10	25.2	400	0.67	240
ELJNAR15MF	0.150					350	0.72	230
ELJNAR18MF	0.180					320	0.81	220
ELJNAR22KF	0.220	1.0	±10 %	13	7.96	280	0.90	210
ELJNAR27KF	0.270					250	1.00	200
ELJNAR33KF	0.330					220	1.10	190
ELJNAR39KF	0.390					200	1.20	180
ELJNAR47KF	0.470					180	1.40	175
ELJNAR56KF	0.560					160	1.50	170
ELJNAR68KF	0.680					150	1.70	155
ELJNAR82KF	0.820					135	1.90	145
ELJNA1R0JF	1.000					120	2.10	125
ELJNA1R2JF	1.200					110	2.30	120
ELJNA1R5JF	1.500	95	2.70	115				
ELJNA1R8JF	1.800	85	3.00	110				
ELJNA2R2JF	2.200	80	3.20	110				
ELJNA2R7JF	2.700	70	3.60	105				
ELJNA3R3JF	3.300	62	4.20	100				
ELJNA3R9JF	3.900	57	4.40	95				
ELJNA4R7JF	4.700	52	7.70	70				
ELJNA5R6JF	5.600	46	8.70	65				
ELJNA6R8JF	6.800	42	10.00	60				
ELJNA8R2JF	8.200	38	11.00	60				

*1 : Self Resonant Frequency *2 : DC Resistance

Design and specifications are subject to change without notice. Ask factory for technical specifications before purchase and/or use.
Whenever a doubt about safety arises from this product, please contact us immediately for technical consultation.

2. Type Non Wound (High-Q) QF

■ Type 1005(0402)QF

● Dimensions in mm (not to scale)

● Recommended Land Pattern in mm (not to scale)

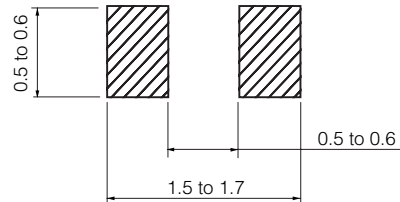
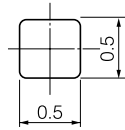

■ Standard Packing Quantity

● 10000 pcs./Reel

■ Examples

Part No.	Inductance			Q		SRF *1 (MHz)min.	DCR *2 (Ω)max.	DC Current (mA)max.	
	(μH)	Tolerance	Freq. (MHz)	100 MHz min.	800 MHz typ.				
ELJQF1N0D/ZF	1.0	±0.3 nH	100	10	41	6000	0.05	400	
ELJQF1N2D/ZF	1.2					6000	0.06	400	
ELJQF1N5D/ZF	1.5				40	6000	0.07	400	
ELJQF1N8D/ZF	1.8					6000	0.08	400	
ELJQF2N2D/ZF	2.2					6000	0.09	400	
ELJQF2N7D/ZF	2.7					5500	0.10	400	
ELJQF3N3D/ZF	3.3					39	5500	0.12	400
ELJQF3N9D/ZF	3.9						5200	0.15	360
ELJQF4N7D/ZF	4.7				4800		0.17	360	
ELJQF5N6D/ZF	5.6				4600		0.19	340	
ELJQF6N8J/ZF	6.8	4000	0.30	320					
ELJQF8N2J/ZF	8.2	3500	0.35	320					
ELJQF10NJ/GF	10.0	±5 %	±2 %	38	2800		0.41	320	
ELJQF12NJ/GF	12.0				2800	0.45	320		
ELJQF15NJ/GF	15.0				36	2500	0.60	240	
ELJQF18NJ/GF	18.0			2200		0.70	240		
ELJQF22NJ/GF	22.0			2200		0.80	200		
ELJQF27NJ/GF	27.0			1800		1.20	200		
ELJQF33NJ/GF	33.0			35	1800	1.40	170		
ELJQF39NJ/GF	39.0	1800	1.70		150				

*1 : Self Resonant Frequency *2 : DC Resistance

3. Normal Types FC, FA, FB

■ Type 2520(1008)FC

● Dimensions in mm (not to scale)

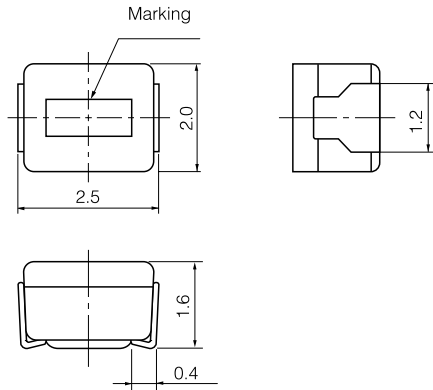

● Recommended Land Pattern in mm (not to scale)



■ Standard Packing Quantity

● 2000 pcs./Reel

■ Examples

Part No.	Inductance		Q min.	L, Q Test Freq. (MHz)	SRF *1 (MHz)min.	DCR *2 (Ω)max.	DC Current (mA)max.	
	(μH)	Tolerance						
ELJFCR22M/KF	0.22	±20 % ±10 %	25	25.2	230	0.70	190	
ELJFCR27M/KF	0.27				210	0.75	180	
ELJFCR33M/KF	0.33				190	0.85	170	
ELJFCR39M/KF	0.39				175	0.95	160	
ELJFCR47M/KF	0.47				160	1.00	155	
ELJFCR56M/KF	0.56				150	1.10	150	
ELJFCR68M/KF	0.68				135	1.25	140	
ELJFCR82M/KF	0.82				125	1.40	130	
ELJFC1R0K/JF	1.00	±10 % ± 5 %		7.96	115	0.65	195	
ELJFC1R2K/JF	1.20				100	0.75	180	
ELJFC1R5K/JF	1.50				90	0.85	170	
ELJFC1R8K/JF	1.80				85	0.95	160	
ELJFC2R2K/JF	2.20				80	1.05	155	
ELJFC2R7K/JF	2.70				75	1.20	145	
ELJFC3R3K/JF	3.30				65	1.30	135	
ELJFC3R9K/JF	3.90				60	1.40	130	
ELJFC4R7K/JF	4.70		55		1.55	125		
ELJFC5R6K/JF	5.60		50		1.75	120		
ELJFC6R8K/JF	6.80		45		1.95	115		
ELJFC8R2K/JF	8.20		40		2.20	105		
ELJFC100K/JF	10.00		20		2.52	32	3.50	80
ELJFC120K/JF	12.00					30	3.80	75
ELJFC150K/JF	15.00	28		4.40		70		
ELJFC180K/JF	18.00	25		5.00		65		
ELJFC220K/JF	22.00	22		5.80		60		
ELJFC270K/JF	27.00	21		6.30		115		
ELJFC330K/JF	33.00	20		7.10		110		
ELJFC390K/JF	39.00	18		9.50		90		
ELJFC470K/JF	47.00	17		11.00		80		
ELJFC560K/JF	56.00	16		12.10		75		
ELJFC680K/JF	68.00	15	16.60	70				
ELJFC820K/JF	82.00	13	19.00	65				
ELJFC101K/JF	100.00	15	0.796	12	21.00	60		

*1 : Self Resonant Frequency *2 : DC Resistance

■ Type 3225(1210)FA

● Dimensions in mm (not to scale)

● Recommended Land Pattern in mm (not to scale)

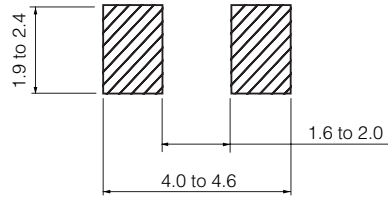

■ Standard Packing Quantity

● 2000 pcs./Reel

■ Examples

Part No.	Inductance		Q min.	L, Q Test Freq. (MHz)	SRF *1 (MHz)min.	DCR *2 (Ω)max.	DC Current (mA)max.
	(μH)	Tolerance					
ELJFAR22M/KF2	0.22	±20 % ±10 %	25	25.2	230	0.29	360
ELJFAR27M/KF2	0.27				210	0.32	345
ELJFAR33M/KF2	0.33				190	0.35	330
ELJFAR39M/KF2	0.39				175	0.39	305
ELJFAR47M/KF2	0.47				160	0.44	290
ELJFAR56M/KF2	0.56				150	0.49	275
ELJFAR68M/KF2	0.68				135	0.55	260
ELJFAR82M/KF2	0.82				125	0.61	245
ELJFA1R0K/JF2	1.00				±10 % ±5 %	30	7.96
ELJFA1R2K/JF2	1.20	100	0.75	215			
ELJFA1R5K/JF	1.50	90	0.75	210			
ELJFA1R8K/JF	1.80	85	0.82	200			
ELJFA2R2K/JF	2.20	80	0.95	190			
ELJFA2R7K/JF	2.70	75	1.10	180			
ELJFA3R3K/JF	3.30	65	1.20	180			
ELJFA3R9K/JF	3.90	60	1.30	175			
ELJFA4R7K/JF	4.70	55	1.50	165			
ELJFA5R6K/JF	5.60	50	1.60	160			
ELJFA6R8K/JF	6.80	45	1.80	150			
ELJFA8R2K/JF	8.20	40	2.00	140			
ELJFA100K/JF	10.00	36	2.10	140			
ELJFA120K/JF	12.00	33	2.50	125			
ELJFA150K/JF	15.00	30	2.80	120			
ELJFA180K/JF	18.00	27	3.30	110			
ELJFA220K/JF	22.00	25	3.70	105			
ELJFA270K/JF	27.00	22	5.00	90			
ELJFA330K/JF	33.00	20	5.60	85			
ELJFA390K/JF	39.00	20	6.40	80			
ELJFA470K/JF	47.00	15	7.00	75			
ELJFA560K/JF	56.00	15	8.00	70			
ELJFA680K/JF	68.00	15	9.00	65			
ELJFA820K/JF	82.00	11	10.00	60			
ELJFA101K/JF	100.00	10	10.00	60			
ELJFA121K/JF	120.00	10	11.00	55			
ELJFA151K/JF	150.00	8	15.00	50			
ELJFA181K/JF	180.00	7	17.00	50			
ELJFA221K/JF	220.00	7	21.00	45			

*1 : Self Resonant Frequency *2 : DC Resistance

■ Type 4532(1812)FB

● Dimensions in mm (not to scale)



● Recommended Land Pattern in mm (not to scale)

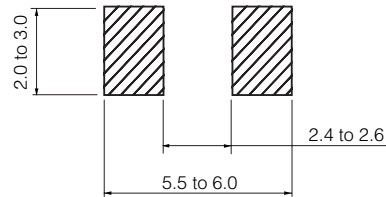

■ Standard Packing Quantity

● 500 pcs./Reel

■ Examples

Part No.	Inductance			Q		SRF *1 (MHz)min.	DCR *2 (Ω)max.	DC Current (mA)max.			
	(μH)	Freq. (MHz)	Tolerance	min.	Freq. (MHz)						
ELJFBR22MF	0.22	1.0	±20 %	30	25.2	230.0	0.30	700			
ELJFBR27MF	0.27					200.0	0.32	650			
ELJFBR33MF	0.33					180.0	0.35	630			
ELJFBR39MF	0.39					155.0	0.37	620			
ELJFBR47MF	0.47					135.0	0.40	580			
ELJFBR56MF	0.56					120.0	0.42	560			
ELJFBR68MF	0.68					105.0	0.48	530			
ELJFBR82MF	0.82					90.0	0.50	500			
ELJFB1R0M/KF	1.00					80.0	0.52	470			
ELJFB1R2M/KF	1.20					70.0	0.55	460			
ELJFB1R5M/KF	1.50		60.0	0.61	430						
ELJFB1R8M/KF	1.80		50.0	0.61	410						
ELJFB2R2M/KF	2.20		±20 %	50	7.96	45.0	0.61	410			
ELJFB2R7M/KF	2.70					43.0	0.61	400			
ELJFB3R3M/KF	3.30					39.0	0.66	380			
ELJFB3R9M/KF	3.90					36.0	0.74	360			
ELJFB4R7M/KF	4.70					±10 %	40	5	33.0	0.81	350
ELJFB5R6M/KF	5.60								30.0	0.88	330
ELJFB6R8M/KF	6.80								26.0	1.00	310
ELJFB8R2M/KF	8.20								24.0	1.60	250
ELJFB100K/JF	10.00	22.0							1.80	235	
ELJFB120K/JF	12.00	20.0							1.90	225	
ELJFB150K/JF	15.00	18.0	2.10	215							
ELJFB180K/JF	18.00	16.0	2.30	205							
ELJFB220K/JF	22.00	15.0	2.60	195							
ELJFB270K/JF	27.00	13.0	2.90	185							
ELJFB330K/JF	33.00	12.0	3.10	175							
ELJFB390K/JF	39.00	10.0	3.60	165							
ELJFB470K/JF	47.00	±5 %	30	2.52	9.7	4.20	130				
ELJFB560K/JF	56.00				9.0	4.70	125				
ELJFB680K/JF	68.00				8.2	5.30	115				
ELJFB820K/JF	82.00				7.5	5.90	110				
ELJFB101K/JF	100.00				6.7	8.80	105				
ELJFB121K/JF	120.00				±10 %	40	1.5	6.1	10.00	100	
ELJFB151K/JF	150.00							5.5	11.00	95	
ELJFB181K/JF	180.00							5.1	13.00	85	
ELJFB221K/JF	220.00							4.5	13.00	85	
ELJFB271K/JF	270.00							4.1	14.00	80	
ELJFB331K/JF	330.00	3.7	16.00	75							
ELJFB391K/JF	390.00	3.3	19.00	70							
ELJFB471K/JF	470.00	3.3	31.00	55							
ELJFB561K/JF	560.00	2.7	35.00	50							
ELJFB681K/JF	680.00	2.5	39.00	50							
ELJFB821K/JF	820.00	2.4	45.00	45							
ELJFB102K/JF	1000.00	2.1	53.00	40							

*1 : Self Resonant Frequency *2 : DC Resistance

4. Magnetic Shielded Type SA

■ Type 3225(1210)SA

● Dimensions in mm (not to scale)

● Recommended Land Pattern in mm (not to scale)

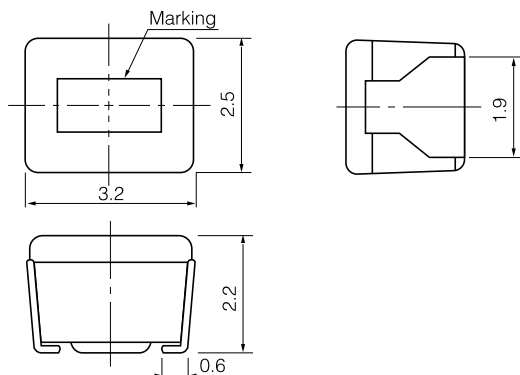

■ Standard Packing Quantity

● 2000 pcs./1 reel

■ Examples

Part No.	Inductance			Q		SRF *1 (MHz)min.	DCR *2 (Ω)max.	DC Current (mA)max.
	(μH)	Freq. (MHz)	Tolerance	min.	Freq. (MHz)			
ELJSA100KF	10	1.0	±10 %	40	5.0	30	1.8	18
ELJSA120KF	12					28	2.0	17
ELJSA150KF	15					25	2.2	15
ELJSA180KF	18					23	2.5	13
ELJSA220KF	22					20	2.8	12
ELJSA270KF	27					18	3.2	10
ELJSA330KF	33					17	3.5	10
ELJSA390KF	39					15	3.8	9
ELJSA470KF	47					14	4.0	8
ELJSA560KF	56					13	4.5	7
ELJSA680KF	68					12	5.0	6
ELJSA820KF	82					11	6.0	6
ELJSA101KF	100					10	7.0	5
ELJSA121KF	120	0.1			1.5	9	8.0	5
ELJSA151KF	150					5	9.0	5
ELJSA181KF	180					5	11.0	5
ELJSA221KF	220					4	12.0	5
ELJSA271KF	270					4	14.0	5

*1 : Self Resonant Frequency *2 : DC Resistance

5. High Power Types PF, PE, PC, PA, PB

■ Type 1005(0402)PF

● Dimensions in mm (not to scale)

● Recommended Land Pattern in mm (not to scale)

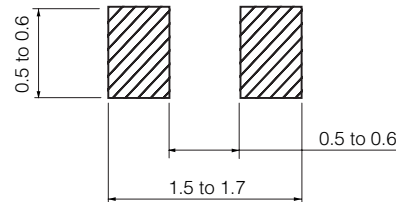
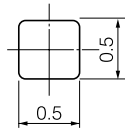
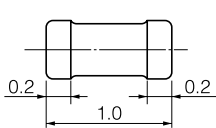

■ Standard Packing Quantity

● 10000 pcs./Reel

■ Examples

Part No.*3	Inductance		Q min.	L, Q Test Freq. (MHz)	SRF*1 (MHz)min.	DCR*2 (Ω)max.	DC Current (mA)max.
	(nH)	Tolerance					
ELJPF2N2DF	2.2	± 0.3 nH	7	100	5300	0.04	1900
ELJPF2N7DF	2.7						
ELJPF3N3DF	3.3						
ELJPF3N9DF	3.9						
ELJPF4N7DF	4.7						
ELJPF5N6DF	5.6						
ELJPF6N8JF	6.8	± 5 %			4000	0.16	1100
ELJPF8N2JF	8.2						
ELJPF10NJF	10.0						

*1 : Self Resonant Frequency *2 : DC Resistance *3 Lead-Free P/Ns have an "FB" suffix, rather than 'F'

■ Type 1608(0603)PE

● Dimensions in mm (not to scale)

● Recommended Land Pattern in mm (not to scale)

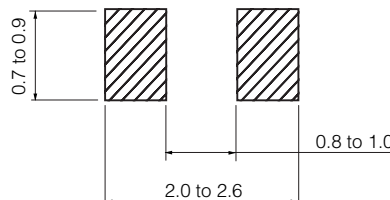

■ Standard Packing Quantity

● 3000 pcs./Reel

■ Examples

Part No.*3	Inductance		Q min.	L, Q Test Freq. (MHz)	SRF *1 (MHz) min.	DCR *2 (Ω)max.	DC Current (mA)max.
	(nH)	Tolerance					
ELJPE2N2KF	2.2	± 10 %	8	100	6000	0.030	2100
ELJPE2N7KF	2.7				5500	0.030	2100
ELJPE3N3KF	3.3				5500	0.040	2100
ELJPE3N9KF	3.9		5200		0.040	2100	
ELJPE4N7KF	4.7		4800		0.050	2100	
ELJPE5N6KF	5.6		4600		0.055	2100	
ELJPE6N8KF	6.8		4000		0.055	1900	
ELJPE8N2KF	8.2		3500		0.060	1700	
ELJPE10NKF	10.0		2800		0.065	1400	
ELJPE12NKF	12.0		2500		0.080	1300	
ELJPE15NKF	15.0		2200		0.100	900	
ELJPE18NKF	18.0		2000		0.120	800	
ELJPE22NKF	22.0		1800		0.150	700	

*1 : Self Resonant Frequency *2 : DC Resistance *3 Lead-Free P/Ns have an "FA" suffix, rather than 'F'

■ Type 2520(1008)PC

● Dimensions in mm (not to scale)

● Recommended Land Pattern in mm (not to scale)

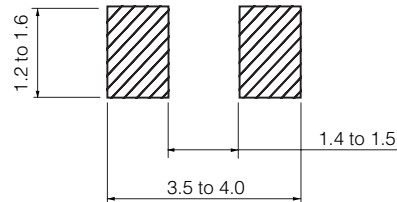
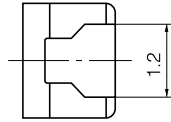

■ Standard Packing Quantity

● 2000 pcs./Reel

■ Examples

Part No.	Inductance		Q min.	L , Q Test Freq. (MHz)	SRF *1 (MHz)min.	DCR *2 (Ω)max.	DC Current (mA)max.
	(μH)	Tolerance					
ELJPC1R0MF	1.0	±20 %	10	7.96	95	0.45	475
ELJPC1R5MF	1.5				85	0.55	435
ELJPC2R2MF	2.2				65	0.65	390
ELJPC3R3MF	3.3				55	0.85	340
ELJPC4R7MF	4.7				8	1.20	285
ELJPC6R8KF	6.8	±10 %	8.5	2.52	44	1.30	170
ELJPC100KF	10.0		20		32	2.20	210
ELJPC120KF	12.0				25	2.70	195
ELJPC150KF	15.0				21	3.20	175
ELJPC220KF	22.0				18	4.00	160
ELJPC330KF	33.0				16	6.50	120

*1 : Self Resonant Frequency *2 : DC Resistance

■ Type 3225(1210)PA

● Dimensions in mm (not to scale)



● Recommended Land Pattern in mm (not to scale)



■ Standard Packing Quantity

- 2000 pcs./Reel

■ Examples

Part No.	Inductance		Q min.	L, Q Test Freq. (MHz)	SRF *1 (MHz)min.	DCR *2 (Ω)max.	DC Current (mA)max.
	(μH)	Tolerance					
ELJPA1R0MF	1.0	±20 %	7	7.96	150.0	0.15	600
ELJPA1R5MF	1.5				110.0	0.18	550
ELJPA2R2MF	2.2				80.0	0.23	500
ELJPA3R3MF	3.3				58.0	0.28	400
ELJPA4R7MF	4.7				46.0	0.34	350
ELJPA6R8MF	6.8				38.0	0.42	300
ELJPA100KF	10.0	±10 %	15	2.52	23.0	0.50	240
ELJPA120KF	12.0				21.0	0.60	230
ELJPA150KF	15.0				18.0	0.74	220
ELJPA180KF	18.0				17.0	0.90	205
ELJPA220KF	22.0				15.0	1.15	185
ELJPA270KF	27.0				13.0	1.45	165
ELJPA330KF	33.0				12.0	1.65	155
ELJPA390KF	39.0				11.0	1.90	145
ELJPA470KF	47.0				9.5	2.25	135
ELJPA560KF	56.0				8.5	3.30	110
ELJPA680KF	68.0				7.5	3.70	105
ELJPA820KF	82.0				7.0	4.20	100
ELJPA101KF	100.0	20	0.796	6.5	5.00	90	
ELJPA121KF	120.0			6.0	7.00	75	
ELJPA151KF	150.0			5.5	8.00	70	
ELJPA181KF	180.0			5.0	9.50	65	
ELJPA221KF	220.0			4.0	11.00	60	
ELJPA271KF	270.0			3.5	14.50	55	
ELJPA331KF	330.0	3.0	16.00	50			

*1 : Self Resonant Frequency *2 : DC Resistance

Design and specifications are subject to change without notice. Ask factory for technical specifications before purchase and/or use. Whenever a doubt about safety arises from this product, please contact us immediately for technical consultation.

■ Type 4532(1812)PB

● Dimensions in mm (not to scale)



● Recommended Land Pattern in mm (not to scale)

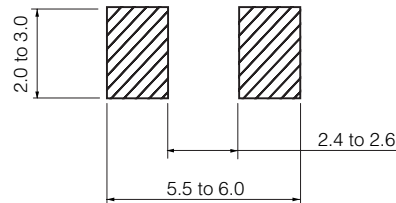

■ Standard Packing Quantity

- 500 pcs./Reel

■ Examples

Part No.	Inductance		Q min.	L, Q Test Freq. (MHz)	SRF *1 (MHz)min.	DCR *2 (Ω)max.	DC Current (mA)max.		
	(μH)	Tolerance							
ELJPB100KF	10	±10 %	10	2.52	19.0	0.65	360		
ELJPB120KF	12				17.0	0.70	340		
ELJPB150KF	15				15.0	0.80	320		
ELJPB180KF	18				14.0	0.90	310		
ELJPB220KF	22				13.0	1.00	300		
ELJPB270KF	27				11.0	1.20	270		
ELJPB330KF	33				10.0	1.40	250		
ELJPB390KF	39				9.5	1.60	230		
ELJPB470KF	47				8.5	1.90	210		
ELJPB560KF	56				8.0	2.20	190		
ELJPB680KF	68				7.0	2.60	170		
ELJPB820KF	82				6.5	3.50	160		
ELJPB101KF	100				20	0.796	6.0	4.00	150
ELJPB121KF	120						5.5	4.50	130
ELJPB151KF	150	5.0	6.50	120					
ELJPB181KF	180	4.5	7.50	110					
ELJPB221KF	220	4.0	9.00	90					

*1 : Self Resonant Frequency *2 : DC Resistance

6. Low DC resistance Type EA

■ Type 3225(1210)EA

● Dimensions in mm (not to scale)

● Recommended Land Pattern in mm (not to scale)

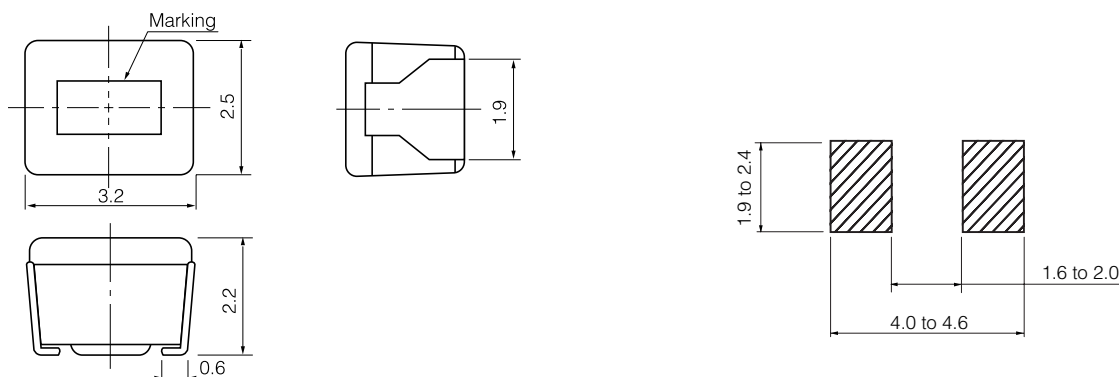

■ Standard Packing Quantity

● 2000 pcs./Reel

■ Examples

Part No.	Inductance		Q min.	L, Q Test Freq. (MHz)	SRF *1 (MHz)min.	DCR *2 (Ω)max.	DC Current (mA)max.
	(μH)	Tolerance					
ELJEA1R0MF	1.0	±20 %	7	7.96	100.0	0.09	500
ELJEA1R5MF	1.5				80.0	0.10	390
ELJEA2R2MF	2.2				65.0	0.13	350
ELJEA3R3MF	3.3				50.0	0.16	270
ELJEA4R7MF	4.7				46.0	0.18	240
ELJEA6R8MF	6.8				36.0	0.25	200
ELJEA100KF	10.0	±10 %	10	2.52	29.0	0.34	160
ELJEA150KF	15.0				25.0	0.42	145
ELJEA220KF	22.0				18.0	0.65	115
ELJEA330KF	33.0				16.0	0.91	95
ELJEA470KF	47.0		13.0	1.30	80		
ELJEA680KF	68.0		10.0	1.95	60		
ELJEA101KF	100.0		20	0.796	8.0	3.12	50
ELJEA151KF	150.0				7.0	4.03	45
ELJEA221KF	220.0	5.0			7.15	35	
ELJEA331KF	330.0	4.0			9.23	30	

*1 : Self Resonant Frequency *2 : DC Resistance