

### 3. General Use FC, FA, FB

Discontinued



#### ■ Features

- General use wire wound, resin molded chip inductor.
- Capable of being Re-flow or flow soldered.
- Wide line-up from 2520 to 4532 case sizes.
- Good for mounting.
- RoHS compliant

#### ■ Recommended Applications

- AV equipment, Wireless communication equipment and various types of general electronic equipment.

#### ■ Explanation of Part Numbers

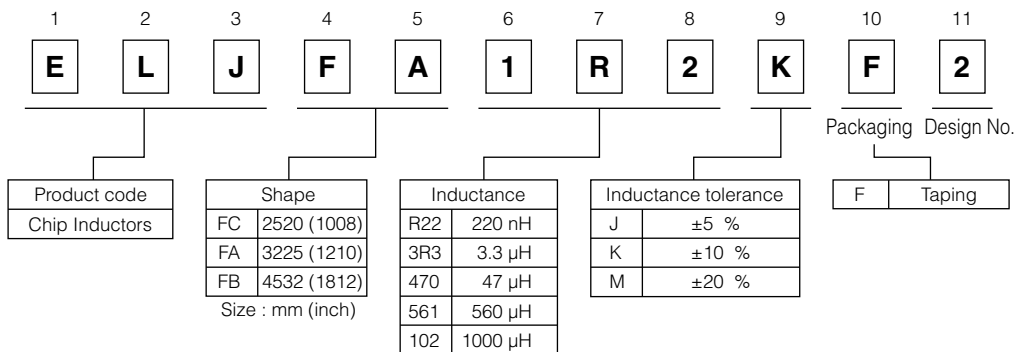

#### ■ Storage Conditions

- Package : Normal temperature (−5 to 35 °C), normal humidity (85 %RH max.), shall not be exposed to direct sunlight and harmful gases and care should be taken so as not to cause dew.
- Operating Temperature : −20 to +85 °C

#### ■ Storage Period

- Solderability may be reduced due to the conditions of high temperature and high humidity which causes the oxidation of tin-plated terminals. Even if storage conditions are within specified limits, solderability may be reduced with the passage of time. Therefore, please control the storage conditions and try to use the product within 6 months of receipt.

#### ■ Packaging Methods, Soldering Conditions and Safety Precautions

Please see Data Files.

■ FC Type 2520 (1008)

● Dimensions in mm (not to scale)

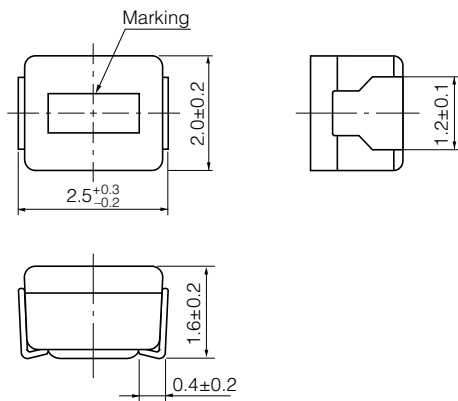

● Recommended Land Pattern in mm (not to scale)

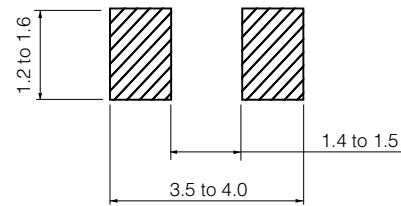

■ Standard Packing Quantity

● 2000 pcs./Reel

■ Standard Parts

Part No.	Inductance			Q		SRF *1 (MHz) min.	R <sub>DC</sub> *2 (Ω) max.	DC Current (mA) max.
	(μH)	Tolerance (%)	Test Freq. (MHz)	min.	Test Freq. (MHz)			
ELJFCR22□F	0.22	M : ±20 % or K : ±10 %	25.2	25	25.2	230	0.70	190
ELJFCR27□F	0.27					210	0.75	180
ELJFCR33□F	0.33					190	0.85	170
ELJFCR39□F	0.39					175	0.95	160
ELJFCR47□F	0.47					160	1.00	155
ELJFCR56□F	0.56					155	1.10	150
ELJFCR68□F	0.68					135	1.25	140
ELJFCR82□F	0.82					125	1.40	130
ELJFC1R0□F	1.0	K : ±10 % or J : ±5 %	7.96	25	7.96	115	0.65	195
ELJFC1R2□F	1.2					100	0.75	180
ELJFC1R5□F	1.5					90	0.85	170
ELJFC1R8□F	1.8					85	0.95	160
ELJFC2R2□F	2.2					80	1.05	155
ELJFC2R7□F	2.7					75	1.20	145
ELJFC3R3□F	3.3					65	1.30	135
ELJFC3R9□F	3.9					60	1.40	130
ELJFC4R7□F	4.7					55	1.55	125
ELJFC5R6□F	5.6					50	1.75	120
ELJFC6R8□F	6.8					45	1.95	115
ELJFC8R2□F	8.2					40	2.20	105
ELJFC100□F	10					32	3.70	80
ELJFC120□F	12					30	4.10	75
ELJFC150□F	15					28	5.00	70
ELJFC180□F	18					25	5.40	65
ELJFC220□F	22	22	6.00	60				
ELJFC270□F	27	2.52	20	2.52	21	6.30	115	
ELJFC330□F	33				20	7.10	110	
ELJFC390□F	39				18	9.50	90	
ELJFC470□F	47				17	11.0	80	
ELJFC560□F	56				16	12.1	75	
ELJFC680□F	68				15	16.6	70	
ELJFC820□F	82				13	19.0	65	
ELJFC101□F	100				0.796	15	0.796	12

□ : Symbol of Tolerance    \*1 : Self Resonant Frequency    \*2 : DC Resistance

■ FA Type 3225 (1210)

● Dimensions in mm (not to scale)

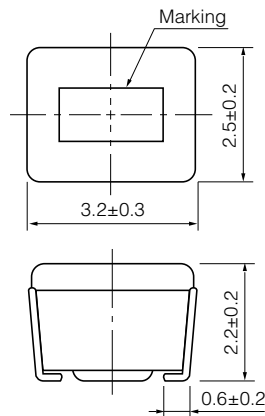

● Recommended Land Pattern in mm (not to scale)

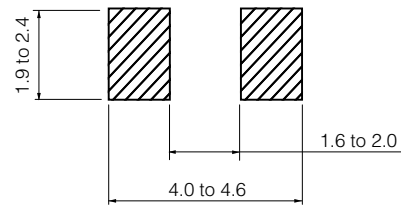

■ Standard Packing Quantity

● 2000 pcs./Reel

■ Standard Parts

Part No.	Inductance			Q		SRF *1 (MHz) min.	R <sub>DC</sub> *2 (Ω) max.	DC Current (mA) max.
	(μH)	Tolerance (%)	Test Freq. (MHz)	min.	Test Freq. (MHz)			
ELJFAR22□F2	0.22	M : ±20 % or K : ±10 %	25.2	25	25.2	230	0.29	360
ELJFAR27□F2	0.27					210	0.32	345
ELJFAR33□F2	0.33					190	0.35	330
ELJFAR39□F2	0.39					175	0.39	305
ELJFAR47□F2	0.47					160	0.44	290
ELJFAR56□F2	0.56					150	0.49	275
ELJFAR68□F2	0.68					135	0.55	260
ELJFAR82□F2	0.82					125	0.61	245
ELJFA1R0□F2	1.0	K : ±10 % or J : ±5 %	7.96	30	7.96	115	0.69	230
ELJFA1R2□F2	1.2					100	0.75	215
ELJFA1R5□F	1.5					90	0.75	210
ELJFA1R8□F	1.8					85	0.82	200
ELJFA2R2□F	2.2					80	0.95	190
ELJFA2R7□F	2.7					75	1.1	180
ELJFA3R3□F	3.3					65	1.2	180
ELJFA3R9□F	3.9					60	1.3	175
ELJFA4R7□F	4.7					55	1.5	165
ELJFA5R6□F	5.6					50	1.6	160
ELJFA6R8□F	6.8					45	1.8	150
ELJFA8R2□F	8.2					40	2.0	140
ELJFA100□F	10					36	2.1	140
ELJFA120□F	12					33	2.5	125
ELJFA150□F	15					30	2.8	120
ELJFA180□F	18					27	3.3	110
ELJFA220□F	22					25	3.7	105
ELJFA270□F	27					22	5.0	90
ELJFA330□F	33					20	5.6	85
ELJFA390□F	39					20	6.4	80
ELJFA470□F	47	15	7.0	75				
ELJFA560□F	56	15	8.0	70				
ELJFA680□F	68	15	9.0	65				
ELJFA820□F	82	10	10.0	60				
ELJFA101□F	100	10	10.0	60				
ELJFA121□F	120	10	11.0	55				
ELJFA151□F	150	8	15.0	50				
ELJFA181□F	180	7	17.0	50				
ELJFA221□F	220	7	21.0	45				

□ : Symbol of Tolerance \*1 : Self Resonant Frequency \*2 : DC Resistance

Design and specifications are each subject to change without notice. Ask factory for the current technical specifications before purchase and/or use. Should a safety concern arise regarding this product, please be sure to contact us immediately.

■ FB Type 4532 (1812)

● Dimensions in mm (not to scale)

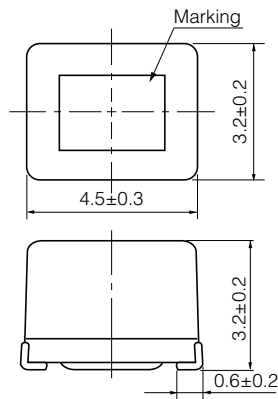

● Recommended Land Pattern in mm (not to scale)

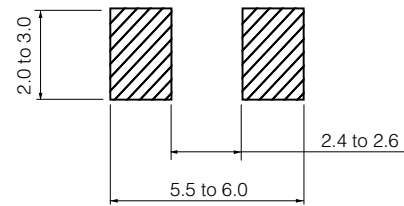

■ Standard Packing Quantity

● 500 pcs./Reel

■ Standard Parts

Part No.	Inductance			Q		SRF *1 (MHz) min.	R <sub>DC</sub> *2 (Ω) max.	DC Current (mA) max.
	(μH)	Tolerance (%)	Test Freq. (MHz)	min.	Test Freq. (MHz)			
ELJFBR22□F	0.22	M : ±20 %	1.0	30	25.2	230	0.30	700
ELJFBR27□F	0.27					200	0.32	650
ELJFBR33□F	0.33					180	0.35	630
ELJFBR39□F	0.39					155	0.37	620
ELJFBR47□F	0.47					135	0.40	580
ELJFBR56□F	0.56					120	0.42	560
ELJFBR68□F	0.68					105	0.48	530
ELJFBR82□F	0.82					90	0.50	500
ELJFB1R0□F	1.0	M:±20 % or K : ±10 %	1.0	50	7.96	80	0.52	470
ELJFB1R2□F	1.2					70	0.55	460
ELJFB1R5□F	1.5					60	0.61	430
ELJFB1R8□F	1.8					50	0.61	410
ELJFB2R2□F	2.2					45	0.61	410
ELJFB2R7□F	2.7					43	0.61	400
ELJFB3R3□F	3.3					39	0.66	380
ELJFB3R9□F	3.9					36	0.74	360
ELJFB4R7□F	4.7					33	0.81	350
ELJFB5R6□F	5.6					30	0.88	330
ELJFB6R8□F	6.8	K : ±10 % or J : ±5 %	0.1	40	5	26	1.0	310
ELJFB8R2□F	8.2					24	1.6	250
ELJFB100□F	10					22	1.8	235
ELJFB120□F	12					20	1.9	225
ELJFB150□F	15					18	2.1	215
ELJFB180□F	18					16	2.3	205
ELJFB220□F	22					15	2.6	195
ELJFB270□F	27					13	2.9	185
ELJFB330□F	33					12	3.1	175
ELJFB390□F	39					10	3.6	165
ELJFB470□F	47	K : ±10 % or J : ±5 %	0.1	30	2.52	9.7	4.2	130
ELJFB560□F	56					9.0	4.7	125
ELJFB680□F	68					8.2	5.3	115
ELJFB820□F	82					7.5	5.9	110
ELJFB101□F	100					6.7	8.8	105
ELJFB121□F	120					6.1	10	100
ELJFB151□F	150					5.5	11	95
ELJFB181□F	180					5.1	13	85
ELJFB221□F	220					4.5	13	85
ELJFB271□F	270					4.1	14	80
ELJFB331□F	330	0.796	0.1	30	1.5	3.7	16	75
ELJFB391□F	390					3.3	19	70
ELJFB471□F	470					3.3	31	55
ELJFB561□F	560					2.7	35	50
ELJFB681□F	680					2.5	39	50
ELJFB821□F	820					2.4	45	45
ELJFB102□F	1000	2.1	53	40				

□ : Symbol of Tolerance \*1 : Self Resonant Frequency \*2 : DC Resistance

Design and specifications are each subject to change without notice. Ask factory for the current technical specifications before purchase and/or use. Should a safety concern arise regarding this product, please be sure to contact us immediately.

### ■ Packaging Methods (Taping)

#### ● Punched Carrier Tape Dimensions in mm (not to scale)

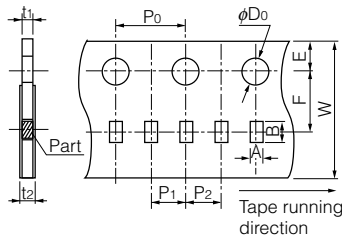

#### ● Embossed Carrier Tape Dimensions in mm (not to scale)

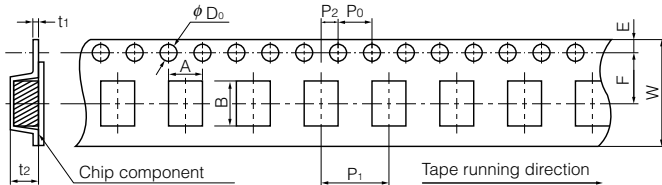
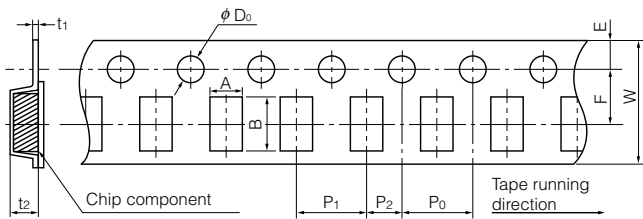
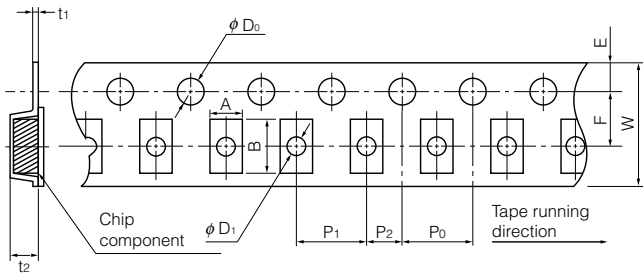

#### ● Taping Reel Dimensions in mm (not to scale)

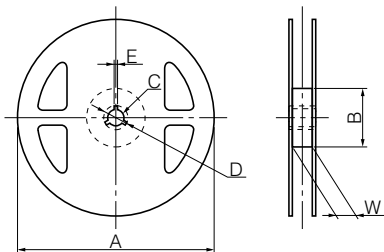

### ■ Standard Packing Quantity/Reel

Types	Quantity	Quantity
RF, QF, PF		10000 pcs.
RE, QE, PE, ND		3000 pcs.
NC, FC, PC, LC, SC		2000 pcs.
NA, FA, PA, LA, SA, EA, DA		2000 pcs.
FB, PB		500 pcs.

#### ● Type □F

	A	B	W	E	F	P <sub>1</sub>
RF, QF, PF	0.71	1.21	8.0	1.75	3.5	2.0
	P <sub>2</sub>	P <sub>0</sub>	φD <sub>0</sub>	t <sub>1</sub>	t <sub>2</sub>	
RF, QF, PF	2.0	4.0	φ1.5	0.7 max.	1.0 max.	

#### ● Type □E, Type ND, Type □C

	A	B	W	E	F	P <sub>1</sub>
RE, QE, PE	1.0	1.8	8.0	1.75	3.5	4.0
ND	1.45	2.25	8.0	1.75	3.5	4.0
NC, FC, PC, LC, SC	2.40	2.90	8.0	1.75	3.5	4.0
	P <sub>2</sub>	P <sub>0</sub>	φD <sub>0</sub>	φD <sub>1</sub>	t <sub>1</sub>	t <sub>2</sub>
RE, QE, PE	2.0	4.0	φ1.5	φ0.6	(0.27)	1.2
ND	2.0	4.0	φ1.5	φ1.0	(0.25)	1.55
NC, FC, PC, LC, SC	2.0	4.0	φ1.5	φ1.1	(0.25)	1.85

#### ● Type □A

	A	B	W	E	F	P <sub>1</sub>
NA, FA, PA, LA, SA, EA, DA	2.80	3.60	8.0	1.75	3.5	4.0
	P <sub>2</sub>	P <sub>0</sub>	φD <sub>0</sub>	t <sub>1</sub>	t <sub>2</sub>	
NA, FA, PA, LA, SA, EA, DA	2.0	4.0	φ1.5	(0.25)	2.40	

#### ● Type □B

	A	B	W	E	F	P <sub>1</sub>
FB, PB	3.60	4.90	12.0	1.75	5.5	8.0
	P <sub>2</sub>	P <sub>0</sub>	φD <sub>0</sub>	t <sub>1</sub>	t <sub>2</sub>	
FB, PB	2.0	4.0	φ1.5	(0.30)	3.50	

Types	Parts					
	A	B	C	D	E	W
RF, QF, PF, RE, QE, PE, ND, NC, FC, PC, LC, SC, NA, FA, PA, LA, SA, EA, DA	180	60	13	21	2	9
FB, PB	180	60	13	21	2	13

\* Under conditions of high temperature and humidity deterioration of the taping and packaging may be accelerated.

Please carefully control storage conditions and use the product within 6 months of receipt.

## Soldering Conditions

### ■ Reflow soldering conditions

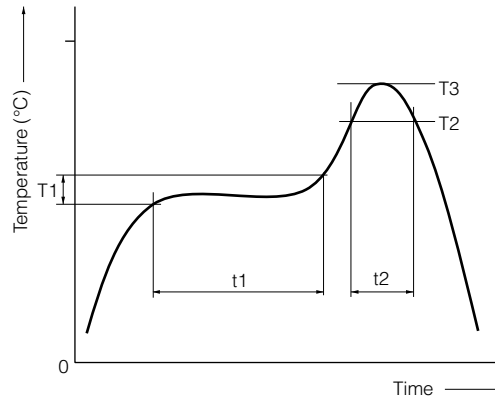

### ● Pb free solder recommended temperature profile

Type	Preheat		Soldering		Peak Temperature		Time of Reflow
	T1 [°C]	t1 [s]	T2 [°C]	t2 [s]	T3	T3 Limit	
□F	150 to 180	60 to 120	230 °C	40 max.	250 °C, 10 s	260 °C, 10 s	2 times max.
□E	150 to 180	60 to 120	230 °C	40 max.	250 °C, 10 s	260 °C, 10 s	2 times max.
□D	150 to 180	60 to 120	230 °C	40 max.	245 °C, 10 s	250 °C, 10 s	2 times max.
□C	150 to 180	60 to 120	230 °C	40 max.	245 °C, 10 s	250 °C, 10 s	2 times max.
□A	150 to 180	60 to 120	230 °C	40 max.	245 °C, 10 s	250 °C, 10 s	2 times max.
□B	150 to 180	60 to 120	230 °C	40 max.	245 °C, 10 s	250 °C, 10 s	2 times max.

### ■ Flow soldering conditions

Preheat: 130 to 150 °C, 60 to 180 s, Soldering: 260 °C, 5 s max.

### ■ Notes

- Solderability may be reduced due to the conditions of high temperature and high humidity which causes the oxidation of tin-plated terminals. Even if storage conditions are within specified limits, solderability may be reduced with the passage of time. Therefore, please control the storage conditions and try to use the product within 6 months of receipt.
- In case the product has been stored for a period longer than 6 months, use the product only after confirmation of its solderability.

## ⚠ Safety Precautions (Common precautions for Chip Inductors)

- When using our products, no matter what sort of equipment they might be used for, be sure to make a written agreement on the specifications with us in advance. The design and specifications in this catalog are subject to change without prior notice.
- Do not use the products beyond the specifications described in this catalog.
- This catalog explains the quality and performance of the products as individual components. Before use, check and evaluate their operations when installed in your products.
- Install the following systems for a failsafe design to ensure safety if these products are to be used in equipment where a defect in these products may cause the loss of human life or other significant damage, such as damage to vehicles (automobile, train, vessel), traffic lights, medical equipment, aerospace equipment, electric heating appliances, combustion/gas equipment, rotating equipment, and disaster/crime prevention equipment.
- \* Systems equipped with a protection circuit and a protection device
- \* Systems equipped with a redundant circuit or other system to prevent an unsafe status in the event of a single fault

## ⚠ Precautions for use

### 1. Operation range and environments

- ① These products are designed and manufactured for general and standard use in general electronic equipment (e.g. AV equipment, home electric appliances, office equipment, information and communication equipment)
- ② These products are not intended for use in the following special conditions. Before using the products, carefully check the effects on their quality and performance, and determine whether or not they can be used.
  - In liquid, such as water, oil, chemicals, or organic solvent
  - In direct sunlight, outdoors, or in dust
  - In salty air or air with a high concentration of corrosive gas, such as Cl<sub>2</sub>, H<sub>2</sub>S, NH<sub>3</sub>, SO<sub>2</sub>, or NO<sub>2</sub>
  - In an environment where these products cause dew condensation

### 2. Handling

- ① Do not bring magnets or magnetized materials close to the product. The influence of their magnetic field can change the inductance value.
- ② Do not apply strong mechanical shocks by either dropping or collision with other parts.  
Excessive shock can damage the part.

### 3. Land pattern design

- ① Please refer to the recommended land pattern for each type shown on the datasheet.
- ② Avoid placing the chip inductor on any metal pattern except the recommended land pattern because a drop of Q and mutual conductance may occur.
- ③ In case of flow soldering, venting of soldering flux gases should be made for high density assemblies to get a good solder connection.
- ④ In case of reflow soldering, consider the layout because taller components close to chip inductor tend to block thermal conduction.

### 4. Mounting

- ① In general, magnetic and electric characteristics of ferrite cores can be changed by applying excessively strong force. Placement force should not exceed 20 N.
- ② Do not bend or twist the PWB after mounting the part.

### 5. Cleaning

- ① Do not use acid or alkali agents. Some cleaning solvents may damage the part.  
Confirm by testing the reliability in advance of mass production.
- ② If Ultrasonic cleaning is used, please confirm the reliability in advance.  
It is possible that combined resonance of component and PWB and cavitation can cause an abnormal vibration mode to exist causing damage.

### 6. Caution about applying excessive current

The rated current is defined as the smaller value of either the current value when the inductance drops 10 % down from the initial point or the current value when the average temperature of coil inside rises 20 °C up from the initial point. Do not operate product over the specific max. current.

### <Package markings>

Package markings include the product number, quantity, and country of origin.  
In principle, the country of origin should be indicated in English.

Chip Inductors

Discontinued : Wirewound Chip Inductor. D, C, A, B

Type: F, E, D, C, A, B

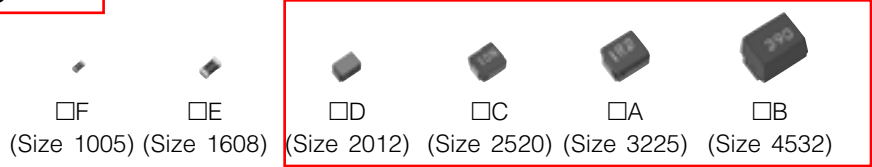





















Ceramic Core/Laser-Cut and wire wound type chip inductors for automatic and high-density mounting  
Wide variation product line-up correspond to various needs

### Recommended Applications

- Cellular phones, wireless communication equipment (W-LAN, Bluetooth), various modules, HIC, TV, VTR, PC & peripherals, DVD, DSC, STB.

### Inductors · Selection Guide

Size : mm (inch)

Technology Case Usage	Non wound		Wire wound <span style="border: 1px solid red; padding: 2px;">Discontinued</span>			
	Size 1005 (0402)	Size 1608 (0603)	Size 2012 (0805)	Size 2520 (1008)	Size 3225 (1210)	Size 4532 (1812)
High Freq. Use	ELJRF  1.0-100 nH	ELJRE  1.0-220 nH	ELJND  10-1000 nH	ELJNC  10-820 nH	ELJNA  47-8200 nH	
High Freq. High-Q	ELJQF  1.0-39 nH	ELJQE  2.2-56 nH				
General Use				ELJFC  0.22-100 μH	ELJFA  0.22-220 μH	ELJFB  0.22-1000 μH
High Power	ELJPF  2.2-10 nH	ELJPE  2.2-22 nH		ELJPC/PC□3 ELJLC  1.0-33 μH	ELJPA/PA□2 ELJLA  1.0-330 μH	ELJPB  10-220 μH
Magnetically Shielded				ELJSC  27-100 μH	ELJSA  10-270 μH	
Low DC Resistance					ELJEA  1.0-330 μH	
Signal Processing Use (Low Distortion Type)					ELJDA/ELJFA   39-100 μH	

Design and specifications are each subject to change without notice. Ask factory for the current technical specifications before purchase and/or use.  
Should a safety concern arise regarding this product, please be sure to contact us immediately.