

Radial Lead Type

Series: **EB** Type : **A**

Country of Origin

Japan
Malaysia
China



- Features Endurance: 105°C 5000 to 10000 h
RoHS directive compliant

■ Specifications

Category temp. range	-40 to +105°C	-25 to +105°C
Rated W.V. Range	10 to 63 V .DC	160 to 450 V .DC
Nominal Cap. Range	0.47 to 3300 μ F	10 to 2200 μ F
Capacitance Tolerance	±20 % (120Hz/+20°C)	±20% (120Hz/+20°C)
DC Leakage Current	$I \leq 0.01 CV$ or $3(\mu A)$ after 2 minutes application of rated working voltage at +20°C(Whichever is greater)	$I \leq 0.05 CV$ or $3(\mu A)$ after 2 minutes application of rated working voltage at +20°C
tan δ	Please see the attached standard products list	
Endurance	After following life test with DC voltage and +105±2°C ripple current value applied (The sum of DC and ripple peak voltage shall not exceed the rated working voltage), the capacitors shall meet the limits specified below. (10 to 63V.DC) Duration : 5000 hours (φ5×11 to 8×11.5), 7000hours (φ5×15 to φ6.3×15) 10000 hours (φ8×15 to 12.5×25) Post test requirement at +20 °C	
	Capacitance change	±30% of initial measured value
	tan δ	≤ 300 % of initial specified value
	DC leakage current	≤ initial specified value
Shelf Life	After storage for 1000 hours at +105±2 °C with no voltage applied and then being stabilized at +20 °C, capacitors shall meet the limits specified in Endurance. (With voltage treatment)	

■ Frequency correction factor for ripple current (10 to 63 V. DC)

Capacitance (μF)	Frequency(Hz)				
	60	120	1k	10k	100k
0.47 to 10	0.75	1	1.40	1.55	1.65
22 to 470	0.85	1	1.20	1.25	1.30
1000 to 3300	0.95	1	1.05	1.10	1.15

■ Dimensions in mm (not to scale)

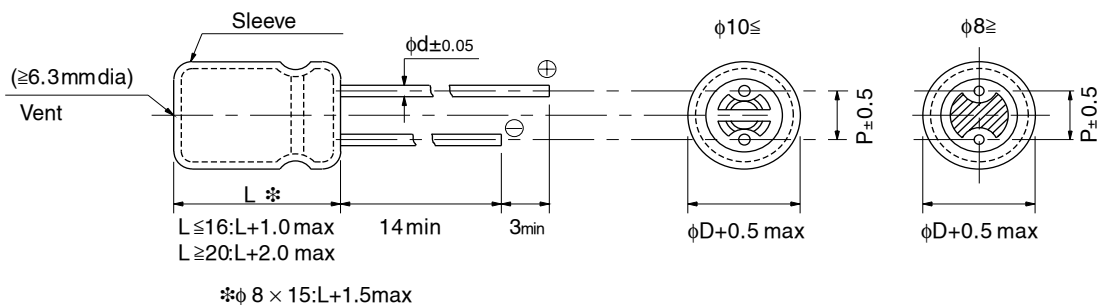

(mm)

	5	6.3	8	10	12.5
Body Dia. φD	5	6.3	8	10	12.5
Lead Dia. φd	0.5	0.5	0.6	0.6	0.6
Lead space P	2.0	2.5	3.5	5.0	5.0

■ Standard Products(Low Voltage)

W.V. (V)	Cap. (±20%) (μF)	Case size		Specification			Lead Length				Part No.	Min. Packaging Qty	
		Dia. (mm)	Length (mm)	Ripple current (120Hz) (+105°C) (mA)	tan δ (120Hz) (+20°C)	Endurance (hours)	Lead Dia. (mm)	Lead Space				Straight Leads (pcs)	Taping (pcs)
								Straight (mm)	Taping *B (mm)	Taping *H (mm)			
10	100	5	15	105	0.30	7000	0.5	2.0	5.0	2.5	EEUEB1A101()	200	2000
		5	11	66	0.30	5000	0.5	2.0	5.0	2.5	EEUEB1A101S()	200	2000
	220	6.3	15	152	0.30	7000	0.5	2.5	5.0	2.5	EEUEB1A221()	200	2000
		6.3	11.2	100	0.30	5000	0.5	2.5	5.0	2.5	EEUEB1A221S()	200	2000
	470	8	15	278	0.30	10000	0.6	3.5	5.0		EEUEB1A471()	200	1000
		8	11.5	180	0.30	5000	0.6	3.5	5.0		EEUEB1A471S()	200	1000
	2200	12.5	20	540	0.32	10000	0.6	5.0	5.0		EEUEB1A222()	200	500
3300	12.5	25	802	0.34	10000	0.6	5.0	5.0		EEUEB1A332()	200	500	
16	1000	10	20	430	0.25	10000	0.6	5.0	5.0		EEUEB1C102()	200	500
	2200	12.5	25	706	0.27	10000	0.6	5.0	5.0		EEUEB1C222()	200	500
25	47	5	15	78	0.22	7000	0.5	2.0	5.0	2.5	EEUEB1E470()	200	2000
		5	11	55	0.22	5000	0.5	2.0	5.0	2.5	EEUEB1E470S()	200	2000
	100	6.3	15	135	0.22	7000	0.5	2.5	5.0	2.5	EEUEB1E101()	200	2000
		6.3	11.2	95	0.22	5000	0.5	2.5	5.0	2.5	EEUEB1E101S()	200	2000
	220	8	11.5	125	0.22	5000	0.6	3.5	5.0		EEUEB1E221S()	200	1000
	330	8	15	255	0.22	10000	0.6	3.5	5.0		EEUEB1E331()	200	1000
	470	10	16	321	0.22	10000	0.6	5.0	5.0		EEUEB1E471()	200	500
1000	12.5	20	498	0.22	10000	0.6	5.0	5.0		EEUEB1E102()	200	500	
35	33	5	15	66	0.18	7000	0.5	2.0	5.0	2.5	EEUEB1V330()	200	2000
		5	11	46	0.18	5000	0.5	2.0	5.0	2.5	EEUEB1V330S()	200	2000
	220	8	15	197	0.18	10000	0.6	3.5	5.0		EEUEB1V221()	200	1000
	330	10	16	278	0.18	10000	0.6	5.0	5.0		EEUEB1V331()	200	500
	470	10	20	349	0.18	10000	0.6	5.0	5.0		EEUEB1V471()	200	500
	1000	12.5	25	586	0.18	10000	0.6	5.0	5.0		EEUEB1V102()	200	500
50	0.47	5	11	4	0.15	5000	0.5	2.0	5.0	2.5	EEUEB1HR47S()	200	2000
	1	5	11	8	0.15	5000	0.5	2.0	5.0	2.5	EEUEB1H1R0S()	200	2000
	2.2	5	11	15	0.15	5000	0.5	2.0	5.0	2.5	EEUEB1H2R2S()	200	2000
	3.3	5	11	18	0.15	5000	0.5	2.0	5.0	2.5	EEUEB1H3R3S()	200	2000
	4.7	5	11	18	0.15	5000	0.5	2.0	5.0	2.5	EEUEB1H4R7S()	200	2000
	10	5	11	27	0.15	5000	0.5	2.0	5.0	2.5	EEUEB1H100S()	200	2000
	22	5	15	55	0.15	7000	0.5	2.0	5.0	2.5	EEUEB1H220()	200	2000
		5	11	39	0.15	5000	0.5	2.0	5.0	2.5	EEUEB1H220S()	200	2000
	47	6.3	15	87	0.15	7000	0.5	2.5	5.0	2.5	EEUEB1H470()	200	2000
		6.3	11.2	61	0.15	5000	0.5	2.5	5.0	2.5	EEUEB1H470S()	200	2000
	100	8	11.5	99	0.15	5000	0.6	3.5	5.0		EEUEB1H101S()	200	1000
	220	10	16	234	0.15	10000	0.6	5.0	5.0		EEUEB1H221()	200	500
	330	10	20	293	0.15	10000	0.6	5.0	5.0		EEUEB1H331()	200	500
470	12.5	20	370	0.15	10000	0.6	5.0	5.0		EEUEB1H471()	200	500	
63	0.47	5	15	6	0.12	7000	0.5	2.0	5.0	2.5	EEUEB1JR47()	200	2000
		5	11	4.5	0.12	5000	0.5	2.0	5.0	2.5	EEUEB1JR47S()	200	2000
	1	5	15	12	0.12	7000	0.5	2.0	5.0	2.5	EEUEB1J1R0()	200	2000
		5	11	9	0.12	5000	0.5	2.0	5.0	2.5	EEUEB1J1R0S()	200	2000

When requesting taped product, please put the letter "B" between the "()". Lead wire pitch B=5mm, H=2.5mm. The taping dimensions are explained on p.196 of our Catalog. Please use it as a reference guide.

■ Standard Products(Low Voltage)

W.V. (V)	Cap. (±20%) (μF)	Case size		Specification			Lead Length				Part No.	Min. Packaging Q'ty	
		Dia. (mm)	Length (mm)	Ripple current (120Hz) (+105°C) (mA)	tan δ (120Hz) (+20°C)	Endurance (hours)	Lead Dia. (mm)	Lead Space				Straight Leads (pcs)	Taping (pcs)
								Straight (mm)	Taping *B (mm)	Taping *H (mm)			
63	2.2	5	15	22	0.12	7000	0.5	2.0	5.0	2.5	EEUEB1J2R2()	200	2000
		5	11	16.5	0.12	5000	0.5	2.0	5.0	2.5	EEUEB1J2R2S()	200	2000
	3.3	5	15	30	0.12	7000	0.5	2.0	5.0	2.5	EEUEB1J3R3()	200	2000
		5	11	20	0.12	5000	0.5	2.0	5.0	2.5	EEUEB1J3R3S()	200	2000
	4.7	5	15	30	0.12	7000	0.5	2.0	5.0	2.5	EEUEB1J4R7()	200	2000
		5	11	23	0.12	5000	0.5	2.0	5.0	2.5	EEUEB1J4R7S()	200	2000
	10	5	15	46	0.12	7000	0.5	2.0	5.0	2.5	EEUEB1J100()	200	2000
		5	11	30	0.12	5000	0.5	2.0	5.0	2.5	EEUEB1J100S()	200	2000
	22	6.3	15	55	0.12	7000	0.5	2.5	5.0	2.5	EEUEB1J220()	200	2000
	33	6.3	15	71	0.12	7000	0.5	2.5	5.0	2.5	EEUEB1J330()	200	2000
		6.3	11.2	50	0.12	5000	0.5	2.5	5.0	2.5	EEUEB1J330S()	200	2000
	47	8	15	94	0.12	10000	0.6	3.5	5.0		EEUEB1J470()	200	1000
		8	11.5	80	0.12	5000	0.6	3.5	5.0		EEUEB1J470S()	200	1000
	100	8	15	180	0.12	10000	0.6	3.5	5.0		EEUEB1J101()	200	1000
	220	10	20	292	0.12	10000	0.6	5.0	5.0		EEUEB1J221()	200	500
	330	12.5	20	381	0.12	10000	0.6	5.0	5.0		EEUEB1J331()	200	500
470	12.5	25	454	0.12	10000	0.6	5.0	5.0		EEUEB1J471()	200	500	

When requesting taped product, please put the letter "B" between the "()". Lead wire pitch B=5mm, H=2.5mm. The taping dimensions are explained on p.196 of our Catalog. Please use it as a reference guide.