



**Compliant with European standards 1a/2a/1a1b 10A/8A polarized power relays**

# DE RELAYS



**RoHS compliant**

Protective construction: Sealed type

### FEATURES

- 1. Conforms to European safety standard (VDE0700 and VDE0631)**  
Insulating distance between coil and contacts:  
Clearance Min. 8mm .315 inch  
Creepage Min. 8mm .315 inch
- 2. Low operating power**  
Nominal operating power at 200 mW (Single side stable, 2 coil latching)
- 3. Compact body saves space**  
Size: 12.5(W) × 25(L) × 12.5(H) mm  
.492(W) × .984(L) × .492(H) inch
- 4. Conforms to the various safety standards**  
UL, C-UL and VDE approved

### TYPICAL APPLICATIONS

1. Temperature controller
2. Automatic meter reading
3. OA equipment
4. FA equipment

## ORDERING INFORMATION

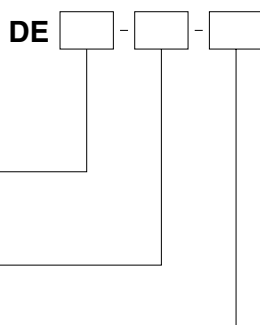

Contact arrangement  
 1a: 1 Form A  
 2a: 2 Form A  
 1a1b: 1 Form A 1 Form B

Operating function  
 Nil: Single side stable  
 L2: 2 coil latching

Nominal coil voltage (DC)  
 5, 12, 24V

Notes: 1. Certified by UL, C-UL and VDE  
 2. This product is manufactured by lot after an order is received.

## TYPES

| Contact arrangement | Nominal coil voltage | Part No.                |                      |
|---------------------|----------------------|-------------------------|----------------------|
|                     |                      | Single side stable type | 2 coil latching type |
| 1 Form A            | 5V DC                | DE1a-5V                 | DE1a-L2-5V           |
|                     | 12V DC               | DE1a-12V                | DE1a-L2-12V          |
|                     | 24V DC               | DE1a-24V                | DE1a-L2-24V          |
| 1 Form A 1 Form B   | 5V DC                | DE1a1b-5V               | DE1a1b-L2-5V         |
|                     | 12V DC               | DE1a1b-12V              | DE1a1b-L2-12V        |
|                     | 24V DC               | DE1a1b-24V              | DE1a1b-L2-24V        |
| 2 Form A            | 5V DC                | DE2a-5V                 | DE2a-L2-5V           |
|                     | 12V DC               | DE2a-12V                | DE2a-L2-12V          |
|                     | 24V DC               | DE2a-24V                | DE2a-L2-24V          |

Standard packing: Tube package: 20 pcs.; Case: 500 pcs.  
 Note: This product is manufactured by lot after an order is received.

## RATING

### 1. Coil data

#### 1) Single side stable type

| Nominal coil voltage | Pick-up voltage (at 20°C 68°F)            | Drop-out voltage (at 20°C 68°F)           | Nominal operating current [ $\pm 10\%$ ] (at 20°C 68°F) | Coil resistance [ $\pm 10\%$ ] (at 20°C 68°F) | Nominal operating power | Max. applied voltage (at 20°C 68°F) |
|----------------------|---|---|---|---|-------------------------|-------------------------------------|
| 5V DC                | 70%V or less of nominal voltage (Initial) | 10%V or more of nominal voltage (Initial) | 40 mA   | 125 $\Omega$                                  | 200mW                   | 130%V of nominal voltage            |
| 12V DC               |   |   | 16.6mA  | 720 $\Omega$                                  |                         |                                     |
| 24V DC               |   |   | 8.3mA   | 2,880 $\Omega$                                |                         |                                     |

#### 2) 2 coil latching type

| Nominal coil voltage | Set voltage (at 20°C 68°F)                | Reset voltage (at 20°C 68°F)              | Nominal operating current [ $\pm 10\%$ ] (at 20°C 68°F) |            | Coil resistance [ $\pm 10\%$ ] (at 20°C 68°F) |                | Nominal operating power |            | Max. applied voltage (at 20°C 68°F) |
|----------------------|---|---|---|------------|---|----------------|-------------------------|------------|-------------------------------------|
|                      |   |   | Set coil  | Reset coil | Set coil                                      | Reset coil     | Set coil                | Reset coil |                                     |
| 5V DC                | 70%V or less of nominal voltage (Initial) | 70%V or less of nominal voltage (Initial) | 40 mA   | 40 mA      | 125 $\Omega$                                  | 125 $\Omega$   | 200mW                   | 200mW      | 130%V of nominal voltage            |
| 12V DC               |   |   | 16.6mA  | 16.6mA     | 720 $\Omega$                                  | 720 $\Omega$   |                         |            |                                     |
| 24V DC               |   |   | 8.3mA   | 8.3mA      | 2,880 $\Omega$                                | 2,880 $\Omega$ |                         |            |                                     |

### 2. Specifications

| Characteristics                          | Item   | Specifications   |  |   |
|--|--|--|--|---|
|  |  | 1 Form A   | 1 Form A 1 Form B  | 2 Form A  |
| Contact                                  | Arrangement  |  |  |   |
|  | Contact resistance (Initial)   | Max. 30 m $\Omega$ (By voltage drop 6 V DC 1A)   |  |   |
|  | Contact material   | AgSnO <sub>2</sub> type  |  |   |
| Rating                                   | Nominal switching capacity (resistive load)  | 10A 250V AC, 10A 30V DC  |  | 8A 250V AC, 8A 30V DC   |
|  | Max. switching power (resistive load)  | 2,500VA, 300W  |  | 2,000VA, 240W   |
|  | Max. switching voltage   | 250V AC, 30V DC  |  | 250V AC, 30V DC   |
|  | Max. switching current   | 10A  |  | 8A  |
|  | Nominal operating power  | 200mW  |  |   |
|  | Min. switching capacity*1  | 100mA 5V DC  |  |   |
| Electrical characteristics               | Insulation resistance (Initial)  | Min. 1,000M $\Omega$ (at 500V DC) Measurement at same location as "Breakdown voltage" section.   |  |   |
|  | Breakdown voltage (Initial)  | Between open contacts  | 1,000 Vrms for 1 min. (Detection current: 10 mA)   |   |
|  |  | Between contact sets   | —  | 4,000 Vrms for 1 min. (Detection current: 10 mA)  |
|  |  | Between contact and coil   | 5,000 Vrms for 1 min. (Detection current: 10 mA)   |   |
|  | Surge breakdown voltage*2 (Between contact and coil)   | 12,000 V (Initial)   |  |   |
|  | Temperature rise (coil) (at 70°C 158°F)  | Single side stable type: Max. 50°C 122°F<br>(By resistive method, nominal voltage applied to the coil, max. switching current)<br>2 coil latching type: Max. 50°C 122°F<br>(By resistive method, coil: de-energized, max. switching current) |  |   |
|  | Operate time [Set time] (at 20°C 68°F)   | Max. 10 ms [Max. 10 ms]<br>(Nominal coil voltage applied to the coil, excluding contact bounce time.)  |  |   |
| Release time [Reset time] (at 20°C 68°F) | Max. 5 ms [Max. 10 ms]<br>(Nominal coil voltage applied to the coil, excluding contact bounce time.) (without diode) |  |  |   |
| Mechanical characteristics               | Shock resistance   | Functional   | Min. 196 m/s <sup>2</sup> (Half-wave pulse of sine wave: 11 ms; detection time: 10 $\mu$ s.) |   |
|  |  | Destructive  | Min. 980 m/s <sup>2</sup> (Half-wave pulse of sine wave: 6 ms.)                              |   |
|  | Vibration resistance   | Functional   | 10 to 55 Hz at double amplitude of 2 mm (Detection time: 10 $\mu$ s.)                        |   |
|  |  | Destructive  | 10 to 55 Hz at double amplitude of 3 mm  |   |
| Expected life                            | Mechanical   | Min. 10 <sup>7</sup> (at 300 times/min.)   |  |   |
|  | Electrical   | Min. 10 <sup>5</sup><br>(resistive load, at 20 times/min., at nominal switching capacity)  |  | Min. 10 <sup>5</sup> (resistive load, at 20 times/min., at AC nominal switching capacity)<br>Min. 5 $\times$ 10 <sup>4</sup> (resistive load, at 20 times/min., at DC nominal switching capacity) |
| Conditions                               | Conditions for operation, transport and storage*3 *4   | Ambient temperature: -40°C to +70°C -40°F to +158°F;<br>Humidity: 5 to 85% R.H. (Not freezing and condensing at low temperature)   |  |   |
|  | Max. operating speed   | 20 times/min. (at nominal switching capacity)  |  |   |
| Unit weight                              |  | Approx. 7 g .25 oz   |  |   |

Notes: \*1. This value can change due to the switching frequency, environmental conditions, and desired reliability level, therefore it is recommended to check this with the actual load.

\*2. Wave is standard shock voltage of  $\pm 1.2 \times 50 \mu$ s according to JEC-212-1981

\*3. The upper limit of the ambient temperature is the maximum temperature that can satisfy the coil temperature rise value. Refer to Usage, transport and storage conditions in NOTES.

\*4. Allowable temperature range with our package form: -40°C to +60°C -40°F to +140°F.

# REFERENCE DATA

1.-(1) Maximum switching power (1 Form A)

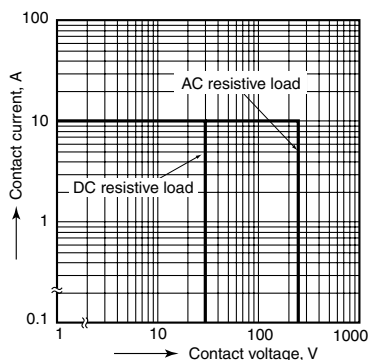

1.-(2) Maximum switching power (1 Form A 1 Form B, 2 Form A)

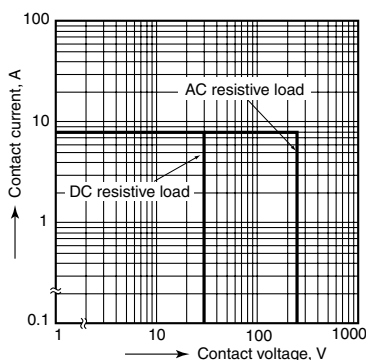

2.-(1) Life curve (1 Form A)

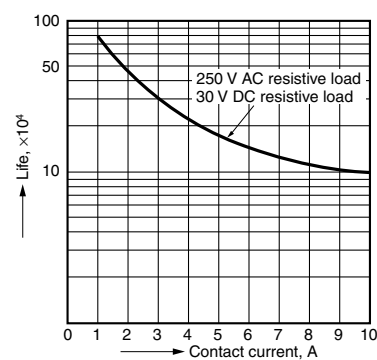

2.-(2) Life curve (1 Form A 1 Form B)

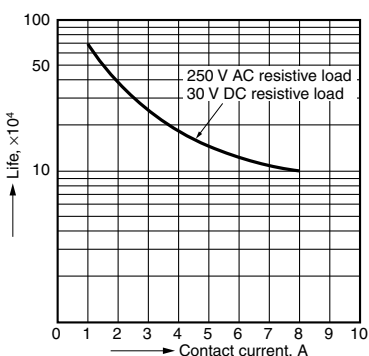

2.-(3) Life curve (2 Form A)

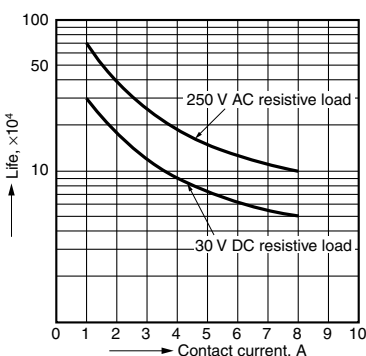

3.-(1) Coil temperature rise (1 Form A)

Tested sample: DE1a-5V  
Quantity: n=6  
Ambient temperature: 25°C to 70°C 77°F to 158°F

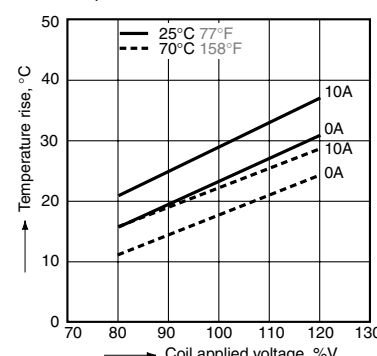

3.-(2) Coil temperature rise (1 Form A 1 Form B)

Tested sample: DE1a1b-5V  
Quantity: n=6  
Ambient temperature: 25°C to 70°C 77°F to 158°F

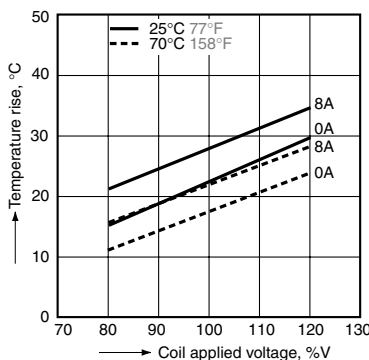

3.-(3) Coil temperature rise (2 Form A)

Tested sample: DE2a-5V  
Quantity: n=6  
Ambient temperature: 25°C to 70°C 77°F to 158°F

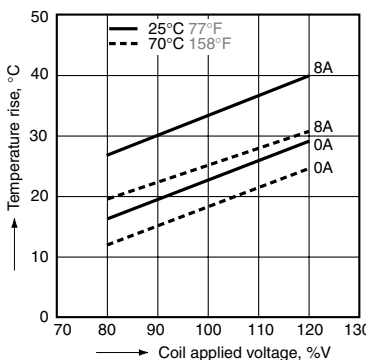

4.-(1) Operate/release time (1 Form A)

Tested sample: DE1a-5V  
Quantity: n=5

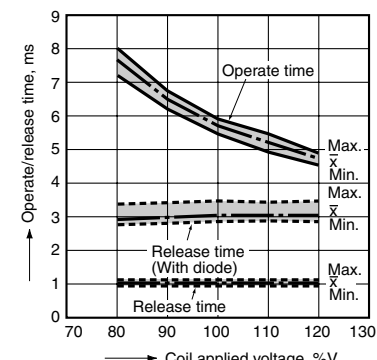

4.-(2) Operate/release time (1 Form A 1 Form B)

Tested sample: DE1a1b-5V, Quantity: n=5

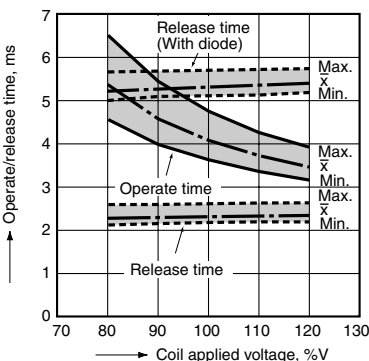

4.-(3) Operate/release time (2 Form A)

Tested sample: DE2a-5V, Quantity: n=5

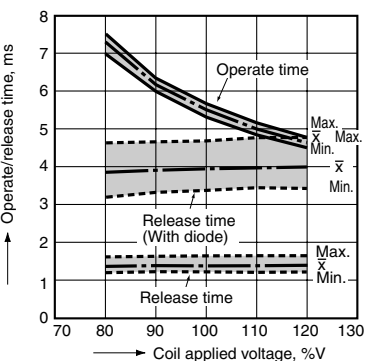

5.-(1) Ambient temperature characteristics (1 Form A)

Tested sample: DE1a-5V, Ambient temperature: -40°C to 80°C -40°F to 176°F, Quantity: n=6

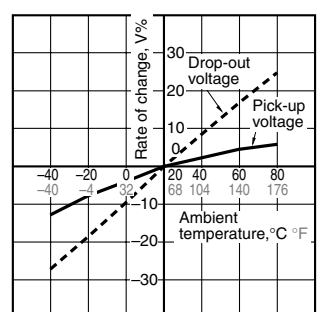

5.-(2) Ambient temperature characteristics  
(1 Form A 1 Form B)

Tested sample: DE1a1b-5V, Ambient temperature:  
-40°C to 80°C -40°F to 176°F, Quantity: n=6

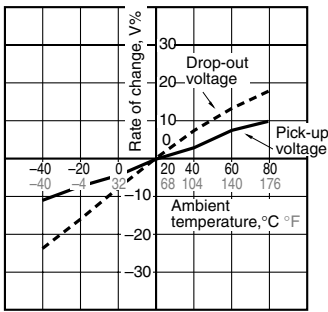

5.-(3) Ambient temperature characteristics  
(2 Form A)

Tested sample: DE2a-5V, Ambient temperature:  
-40°C to 80°C -40°F to 176°F, Quantity: n=6

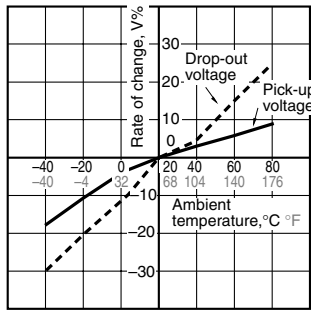

**DIMENSIONS** (mm inch)

The CAD data of the products with a **CAD Data** mark can be downloaded from: <http://industrial.panasonic.com/ac/e/>

**CAD Data**



External dimensions  
Single side stable type

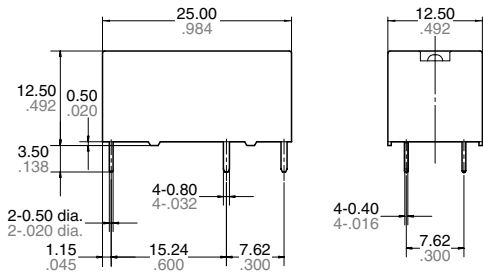

2 coil latching type

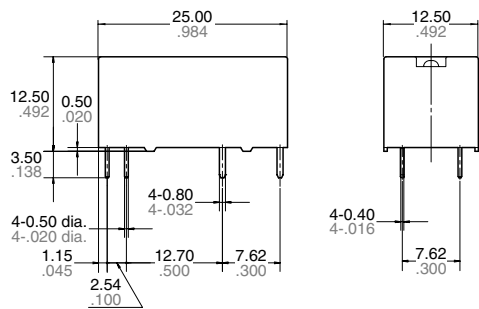

Tolerance:  $\pm 0.3 \pm .012$

PC board pattern (Bottom view)  
Single side stable type      2 coil latching type

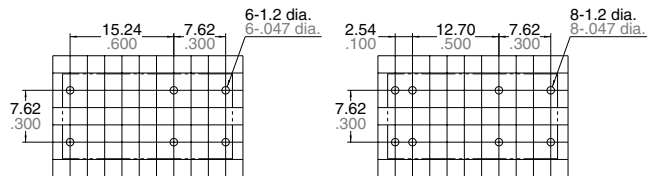

Tolerance:  $\pm 0.1 \pm .004$

Schematic (Bottom view)

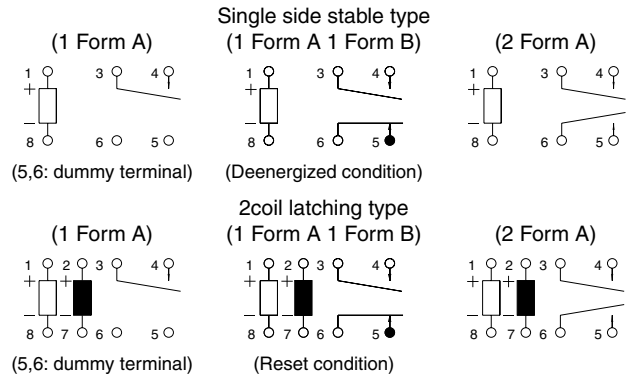

**SAFETY STANDARDS**

| Item                 | UL/C-UL (Recognized) |                         | VDE (Certified) |   |
|----------------------|----------------------|-------------------------|-----------------|---|
|                      | File No.             | Contact rating          | File No.        | Contact rating  |
| 1 Form A             | E120782              | PILOT DUTY B300<br>R300 | 115944          | 8A 250V AC ( $\cos\phi=1.0$ )<br>16A 250V AC ( $\cos\phi=1.0$ ) |
| 1 Form A<br>1 Form B | E120782              | PILOT DUTY B300<br>R300 | 115944          | 8A 250V AC ( $\cos\phi=1.0$ )<br>16A 250V AC ( $\cos\phi=1.0$ ) |
| 2 Form A             | E120782              | PILOT DUTY B300<br>R300 | 115944          | 8A 250V AC ( $\cos\phi=1.0$ )                                   |

\* CSA standard: Certified by C-UL

**NOTES**

1. For cautions for use, please read "GENERAL APPLICATION GUIDELINES" on page B-1.