

Ideal for heater control
1a 16A, 10.9 mm height flat
power relays

JV-N RELAYS



RoHS compliant

FEATURES

- **High 16 A capacity**
The contacts are high capacity 16A, 125 V AC.
- **Compact, flat type with low 10.9 mm .429 inch height**
Compact flat type with low surface area of 16 × 22 mm .630 × .866 inch and height of 10.9 mm .429 inch.
- **High sensitivity at 200 mW**
High sensitivity at 200 mW coil power consumption.
- **Represses contact terminal heat**
The contact terminals are large and thick. This limits the rise in temperature of the terminals when there is a large current flowing to approx. 28°C 62°F (normal current of 16 A).
- **Conforms to the various safety standards**
UL, CSA, TÜV approved.

TYPICAL APPLICATIONS

- AV equipment: TV's, VTR's, etc.
- OA equipment
- HA equipment

ORDERING INFORMATION

JVN 1a - - F

Contact arrangement
1a: 1 Form A

Protective construction
Nil: Sealed type
F: Flux-resistant type

Nominal coil voltage (DC)
4.5V, 6V, 9V, 12V, 18V, 24V, 48V, 100V

Contact material
F: AgSnO₂ type

Note: Certified by UL, CSA and TÜV

TYPES

Nominal coil voltage	Flux-resistant type	Sealed type
	Part No.	Part No.
4.5V DC	JVN1aF-4.5V-F	JVN1a-4.5V-F
6V DC	JVN1aF-6V-F	JVN1a-6V-F
9V DC	JVN1aF-9V-F	JVN1a-9V-F
12V DC	JVN1aF-12V-F	JVN1a-12V-F
18V DC	JVN1aF-18V-F	JVN1a-18V-F
24V DC	JVN1aF-24V-F	JVN1a-24V-F
48V DC	JVN1aF-48V-F	JVN1a-48V-F
100V DC	JVN1aF-100V-F	JVN1a-100V-F

Note: Standard packing; Carton: 100 pcs., Case: 500 pcs.
5V type is also available. Please consult us.

RATING

1. Coil data

Nominal coil voltage	Pick-up voltage (at 20°C 68°F)	Drop-out voltage (at 20°C 68°F)	Nominal operating current [$\pm 10\%$] (at 20°C 68°F)	Coil resistance [$\pm 10\%$] (at 20°C 68°F)	Nominal operating power	Max. applied voltage (at 20°C 68°F)
4.5V DC	75%V or less of nominal voltage	5%V or more of nominal voltage	44.4mA	101 Ω	200mW	150%V of nominal voltage
6V DC			33.3mA	180 Ω		
9V DC			22.2mA	405 Ω		
12V DC			16.7mA	720 Ω		
18V DC			11.1mA	1,620 Ω		
24V DC			8.3mA	2,880 Ω		
48V DC			4.2mA	11,520 Ω		
100V DC	Min. 60 VDC	Min. 4 VDC	6 mA	16,600 Ω	600mW	110%V

2. Specifications

Characteristics	Item	Specifications	
Contact	Contact material	AgSnO ₂ type	
	Arrangement	1 Form A	
	Contact resistance (Initial)	Max. 100 m Ω (By voltage drop 6 V DC 1A)	
Rating	Nominal switching capacity (resistive load)	16A 125V AC, 10A 277V AC, 10A 30V DC, 10A 125V AC (Only for Flux-resistance type)	
	Max. switching power (resistive load)	2,770VA, 300W	
	Max. switching voltage	277V AC, 30V DC	
	Max. switching current	16A (125V AC), 10A (DC)	
	Nominal operating power	200mW (4.5 to 48V DC), 600mW (100V DC)	
	Min. switching capacity (reference value)*1	100mA, 5V DC	
Electrical characteristics	Insulation resistance (Initial)	Min. 1,000M Ω (at 500V DC) Measurement at same location as "Breakdown voltage" section.	
	Breakdown voltage (Initial)	Between open contacts	1,000 Vrms for 1 min. (Detection current: 10 mA)
		Between contact and coil	2,500 Vrms for 1 min. (Detection current: 10 mA)
	Temperature rise (coil)	Max. 45°C 113°F (4.5 to 48V DC), Max. 55°C 131°F (100V DC) [By resistive method, nominal coil voltage applied to the coil; contact carrying current: 16A, at 70°C 158°F (4.5 to 48V DC), at 60°C 140°F (100V DC)]	
	Surge breakdown voltage*2 (Between contact and coil) (Initial)	4,500 V	
	Operate time (at nominal voltage) (at 20°C 68°F)	Max. 12 ms (4.5 to 48V DC), Max. 8 ms (100V DC) (excluding contact bounce time.)	
	Release time (at nominal voltage) (at 20°C 68°F)	Max. 5 ms (excluding contact bounce time) (Without diode)	
Mechanical characteristics	Shock resistance	Functional	200 m/s ² (Half-wave pulse of sine wave: 11 ms; detection time: 10 μ s.)
		Destructive	1,000 m/s ² (Half-wave pulse of sine wave: 6 ms.)
	Vibration resistance	Functional	10 to 55 Hz at double amplitude of 1.6 mm (Detection time: 10 μ s.)
		Destructive	10 to 55 Hz at double amplitude of 2.0 mm
Expected life	Mechanical (at 180 times/min.)	Min. 2 $\times 10^7$	
	Electrical (at 20 times/min.)	Min. 3 $\times 10^4$ (sealed type, 16A 125V AC), Min. 5 $\times 10^4$ (sealed type, 10A 277V AC), Min. 10 ⁵ (sealed type, 10A 30V DC), Min. 10 ⁵ (Flux-resistant type, 10A 125V AC)	
Conditions	Conditions for operation, transport and storage*3	Ambient temperature: -40°C to +70°C -40°F to +158°F (4.5 to 48V DC), -40°C to +60°C -40°F to +140°F (100V DC), Humidity: 5 to 85% R.H. (Not freezing and condensing at low temperature), Air pressure: 86 to 106kPa	
	Max. operating speed	20 times/min. (at nominal switching capacity)	
Unit weight		Approx. 8 g .28 oz	

* Specifications will vary with foreign standards certification ratings.

Notes: *1. This value can change due to the switching frequency, environmental conditions, and desired reliability level, therefore it is recommended to check this with the actual load.

*2. Wave is standard shock voltage of $\pm 1.2 \times 50\mu$ s according to JEC-212-1981

*3. The upper limit of the ambient temperature is the maximum temperature that can satisfy the coil temperature rise value. Refer to Usage, transport and storage conditions in NOTES.

REFERENCE DATA

1. Max. switching power

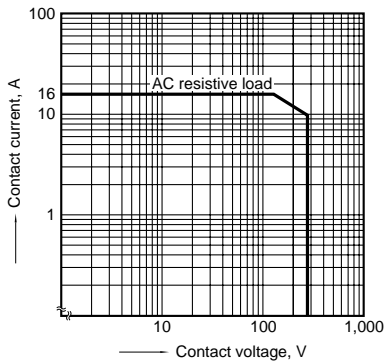

2. Coil temperature rise

Sample: JVN1aF-12 V-F, 6 pcs.
point measured: coil inside
Contact current: 16 A

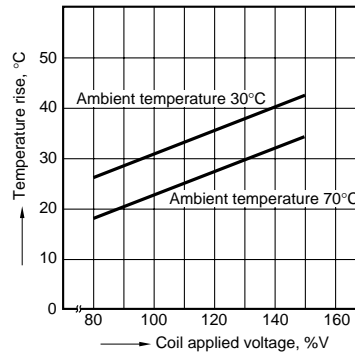

3. Operate/release time

Sample: JVN1aF-12 V-F, 6 pcs.

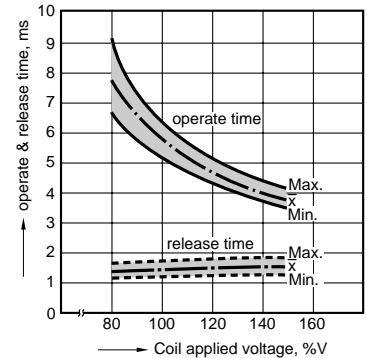

4. Ambient temperature characteristics

Sample: JVN1aF-12 V-F, 6 pcs.

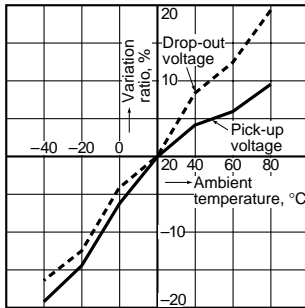

DIMENSIONS (mm inch)

The CAD data of the products with a **CAD Data** mark can be downloaded from: <http://industrial.panasonic.com/ac/e/>

CAD Data

External dimensions

PC board pattern

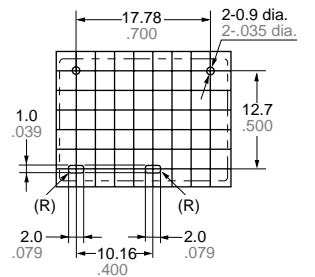
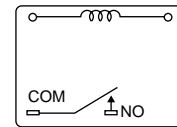
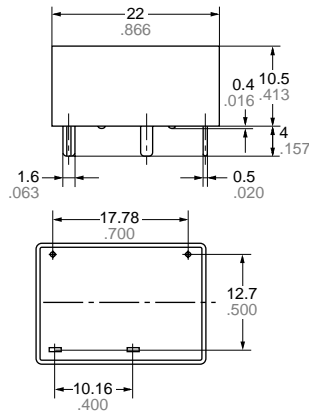

Dimension:

Less than 1mm .039inch:

Min. 1mm .039inch less than 5mm .197 inch: $\pm 0.3 \pm 0.12$

Min. 5mm .197 inch:

General tolerance

$\pm 0.2 \pm 0.08$

$\pm 0.3 \pm 0.12$

$\pm 0.4 \pm 0.16$

SAFETY STANDARDS

UL/C-UL (Recognized)		CSA (Certified)		TÜV (Certified)	
File No.	Contact rating	File No.	Contact rating	File No.	Rating
E43028	16A 125V AC, 16A 277V AC, 10A 30V DC 0.3A 110V DC, 1/10HP 125V AC, 1/10HP 277V AC	LR26550	16A 125V AC, 16A 277V AC, 10A 30V DC 0.3A 110V DC, 1/10HP 125V AC, 1/10HP 277V AC	B 11 05 13461 304	16A 250V AC ($\cos\phi=0.4$) 10A 30V DC (0ms)

For Cautions for Use.