



### Compact Relay Family with Forcibly Guided Contacts

# SF-Y RELAYS



4-pole  
(2 Form A 2 Form B, 3 Form A 1 Form B)



6-pole  
(4 Form A 2 Form B, 5 Form A 1 Form B)

**RoHS compliant**

## FEATURES

- Forcibly guided contact structure**  
Relay complies with EN 50205, Type A  
Equipped with forcibly guided contact structure that enables detection of contact welding and construction of safety circuit.
- Small size**
- Different contact configurations:**

Type	L × W × H (mm inch)
2 Form A 2 Form B, 3 Form A 1 Form B	31.0 × 28.6 × 14.5 1.220 × 1.126 × .571
4 Form A 2 Form B, 5 Form A 1 Form B	39.0 × 28.6 × 14.5 1.535 × 1.126 × .571

- Low profile: 14.5 mm .571 inch**
- Insulation according to EN 60664-1:**  
Overvoltage category III, Pollution degree 2, 250V AC
  - Reinforced insulation:**  
Clearance and creepage 5.5 mm .217 inch  
(between all contacts and between contact NO4 and coil)
  - Basic insulation:**  
Clearance 3 mm .118 inch and creepage 4 mm .157 inch  
(between all contacts and between contact NC3 and coil)

## TYPICAL APPLICATIONS

- Emergency stop switches
- Machine safety engineering
- Safety control units
- Automation technology
- Elevators
- Escalators
- Overcurrent protection with monitor contact

## ORDERING INFORMATION

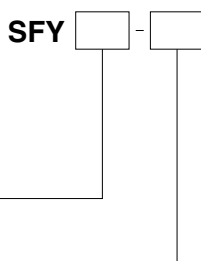

Contact arrangement  
2: 2 Form A 2 Form B  
3: 3 Form A 1 Form B  
4: 4 Form A 2 Form B  
5: 5 Form A 1 Form B

Nominal coil voltage  
DC 5, 12, 16, 18, 21, 24V

Notes: Please consult us about other coil voltages.  
Gold-clad contact type available on request.

## TYPES

Contact arrangement		Nominal coil voltage	Part No.
4-pole	2 Form A 2 Form B	5 V DC	SFY2-DC5V
		12 V DC	SFY2-DC12V
		16 V DC	SFY2-DC16V
		18 V DC	SFY2-DC18V
		21 V DC	SFY2-DC21V
		24 V DC	SFY2-DC24V
	3 Form A 1 Form B	5 V DC	SFY3-DC5V
		12 V DC	SFY3-DC12V
		16 V DC	SFY3-DC16V
		18 V DC	SFY3-DC18V
21 V DC		SFY3-DC21V	
6-pole	4 Form A 2 Form B	5 V DC	SFY4-DC5V
		12 V DC	SFY4-DC12V
		16 V DC	SFY4-DC16V
		18 V DC	SFY4-DC18V
		21 V DC	SFY4-DC21V
		24 V DC	SFY4-DC24V
	5 Form A 1 Form B	5 V DC	SFY5-DC5V
		12 V DC	SFY5-DC12V
		16 V DC	SFY5-DC16V
		18 V DC	SFY5-DC18V
21 V DC		SFY5-DC21V	
		24 V DC	SFY5-DC24V

Standard packing: Tube 20 pcs.

## RATING

### 1. Coil data

Contact arrangement		Nominal coil voltage	Pick-up voltage (at 20°C 68°F)	Drop-out voltage (at 20°C 68°F)	Nominal operating current [±10%] (at 20°C 68°F)	Coil resistance [±10%] (at 20°C 68°F)	Nominal operating power (at 20°C 68°F)	Max. applied voltage (at 20°C 68°F)
4-pole	2 Form A 2 Form B	5V DC	75%V or less of nominal voltage (Initial)	15%V or more of nominal voltage (Initial)	134mA	38Ω	670mW	120%V of nominal voltage
		12V DC			56mA	215Ω		
		16V DC			42mA	380Ω		
		18V DC			37mA	483Ω		
		21V DC			32mA	666Ω		
		24V DC			28mA	864Ω		
	3 Form A 1 Form B	5V DC			134mA	38Ω		
		12V DC			56mA	215Ω		
		16V DC			42mA	380Ω		
		18V DC			37mA	483Ω		
21V DC		32mA	666Ω					
6-pole	4 Form A 2 Form B	5V DC	134mA	38Ω				
		12V DC	56mA	215Ω				
		16V DC	42mA	380Ω				
		18V DC	37mA	483Ω				
		21V DC	32mA	666Ω				
		24V DC	28mA	864Ω				
	5 Form A 1 Form B	5V DC	134mA	38Ω				
		12V DC	56mA	215Ω				
		16V DC	42mA	380Ω				
		18V DC	37mA	483Ω				
21V DC		32mA	666Ω					
		24V DC	28mA	864Ω				

**2. Specifications**

Characteristics	Item	Specifications		
		4-pole	6-pole	
Contact	Contact arrangement	2 Form A 2 Form B, 3 Form A 1 Form B	4 Form A 2 Form B, 5 Form A 1 Form B	
	Forcibly guided contacts	All contacts: Type A, EN 50205		
	Contact resistance (Initial)	Max. 100 mΩ (By voltage drop 6 V DC 1A)		
	Contact material	Au-flashed AgNi alloy type		
Rating	Nominal switching capacity (resistive load)	6A 250V AC, 6A 30V DC		
	Max. switching power (resistive load)	1,500VA, 180W		
	Max. switching voltage	250V AC, 30V DC		
	Max. switching current	6 A		
	Min. switching capacity (Reference value)*1	10mA 10V DC		
Electrical characteristics	Insulation resistance (Initial)	Min. 1,000MΩ (at 500V DC) Measurement at same location as "Breakdown voltage" section.		
		Between open contacts	1,500 Vrms for 1 min. (Detection current: 10mA)	
		Between contact sets	4,000 Vrms for 1 min. (Detection current: 10mA)	
	Breakdown voltage (Initial)	Between contact and coil	NC3: 2,500 Vrms for 1min; NO4: 4,000 Vrms for 1min (Detection current: 10mA)	
		Coil holding voltage*4	Min. 60%V (Initial, at 20°C 68°F)	
	Operate time (at 20°C 68°F)	Max. 20ms (Nominal coil voltage applied to the coil, excluding contact bounce time)		
Release time (at 20°C 68°F)	Max. 10ms (Nominal coil voltage applied to the coil, excluding contact bounce time) (without diode)			
Mechanical characteristics	Shock resistance	Functional	200 m/s <sup>2</sup> (Half-wave pulse of sine wave: 11 ms; detection time: 10μs)	
		Destructive	1,000 m/s <sup>2</sup> (Half-wave pulse of sine wave: 6 ms)	
	Vibration resistance	Functional	10 to 55 Hz at double amplitude of 1.5 mm .059 inch (Detection time: 10μs)	
		Destructive	10 to 55 Hz at double amplitude of 1.5 mm .059 inch	
Expected life	Mechanical	Min. 10 <sup>7</sup> (at 180 times/min.)		
	Electrical	250 V AC 6 A resistive load: Min. 10 <sup>5</sup> (at 20 times/min.)		
Degree of protection	RT III*3			
Conditions	Conditions for operation, transport and storage*2	Ambient temperature: -40°C to +70°C -40°F to +158°F Humidity: 5 to 85% R.H. (Not freezing and condensing at low temperature)		
	Max. Operating speed	20 times/min. (at nominal voltage)		
Unit weight	Approx. 19 g .67 oz		Approx. 23 g .81 oz	

- Notes: \*1. This value can change due to the switching frequency, environmental conditions, and desired reliability level, therefore it is recommended to check this with the actual load.  
 \*2. The upper limit of the ambient temperature is the maximum temperature that can satisfy the coil temperature rise value. Refer to Usage, transport and storage conditions in NOTES.  
 \*3. According to EN 61810-1:2010, table 2. Characteristic is sealed construction with terminals, case and base sealed shut with sealing resin. Construction is designed to prevent seeping of flux when soldering and cleaning fluid when cleaning. Harmful substances on the contacts are removed by gas purging before sealing with.  
 \*4. Coil holding voltage is the coil voltage after 100 ms from the applied nominal voltage.

**Important: Relay characteristics may be influenced by:**

- strong external magnetic fields
- magnetic conductive materials near the relay
- narrow top-to-top mounting (printed surface to printed surface)

**Insulation**

2 Form A 2 Form B	3 Form A 1 Form B	4 Form A 2 Form B	5 Form A 1 Form B

- = Reinforced insulation: overvoltage category III, pollution degree 2, 250V AC (Clearance and creepage distance is 5.5 mm .217 inch or more between contact sets shown by "————". Also, there is 5.5 mm .217 inch or more clearance and creepage distance even between contact NO4 and coil.)  
 - - - - = Basic insulation: overvoltage category III, pollution degree 3, 250V AC (Between contact NC3 and coil shown by "- - - -", the clearance is 3 mm .118 inch or more and the creepage distance is 4 mm .157 inch or more.)

## Other contact gaps when contacts are welded

The table below shows the state of the other contacts.  
 In case of form "NO" contact weld the coil applied voltage is 0 V.  
 In case of form "NC" contact weld the coil applied voltage is nominal.

### <2 Form A 2 Form B>

		State of other contacts			
		3-4 (NC)	5-6 (NC)	7-8 (NO)	9-10 (NO)
Welded terminal No.	3-4 (NC)			>0.5	>0.5
	5-6 (NC)			>0.5	>0.5
	7-8 (NO)	>0.5	>0.5		
	9-10 (NO)	>0.5	>0.5		

### <3 Form A 1 Form B>

		State of other contacts			
		3-4 (NC)	5-6 (NO)	7-8 (NO)	9-10 (NO)
Welded terminal No.	3-4 (NC)		>0.5	>0.5	>0.5
	5-6 (NO)	>0.5			
	7-8 (NO)	>0.5			
	9-10 (NO)	>0.5			

### <4 Form A 2 Form B>

		State of other contacts					
		3-4 (NC)	5-6 (NC)	7-8 (NO)	9-10 (NO)	11-12 (NO)	13-14 (NO)
Welded terminal No.	3-4 (NC)			>0.5	>0.5	>0.5	>0.5
	5-6 (NC)			>0.5	>0.5	>0.5	>0.5
	7-8 (NO)	>0.5	>0.5				
	9-10 (NO)	>0.5	>0.5				
	11-12 (NO)	>0.5	>0.5				
	13-14 (NO)	>0.5	>0.5				

### <5 Form A 1 Form B>

		State of other contacts					
		3-4 (NC)	5-6 (NO)	7-8 (NO)	9-10 (NO)	11-12 (NO)	13-14 (NO)
Welded terminal No.	3-4 (NC)		>0.5	>0.5	>0.5	>0.5	>0.5
	5-6 (NO)	>0.5					
	7-8 (NO)	>0.5					
	9-10 (NO)	>0.5					
	11-12 (NO)	>0.5					
	13-14 (NO)	>0.5					

>0.5: contact gap is kept at min. 0.5 mm .020 inch  
 Empty cells: either ON or OFF  
 Note: Contact gaps are shown at the initial state.  
 If the contact transfer is caused by load switching, it is necessary to check the actual loading.

**DIMENSIONS** (mm inch)

The CAD data of the products with a **CAD Data** mark can be downloaded from: <http://industrial.panasonic.com/ac/e/>

**1. 4-pole (2 Form A 2 Form B, 3 Form A 1 Form B)**

**CAD Data**



External dimensions

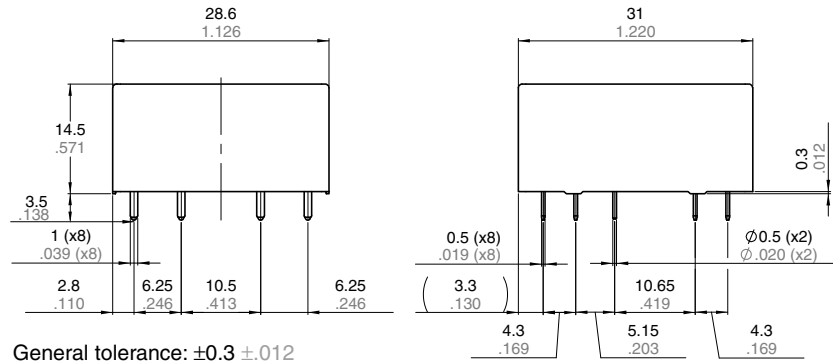

General tolerance:  $\pm 0.3 \pm .012$

Projection mode:

Schematic (Bottom view)

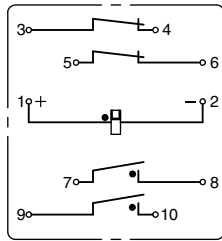

(2 Form A 2 Form B)

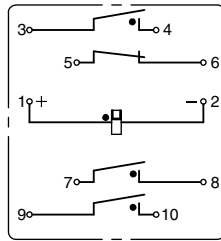

(3 Form A 1 Form B)

PC board pattern (Bottom view)

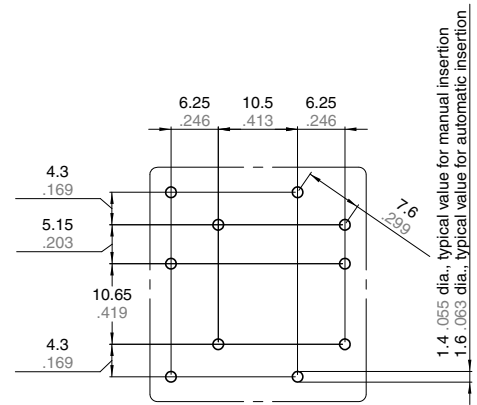

Tolerance:  $\pm 0.1 \pm .004$

2. 6-pole (4 Form A 2 Form B, 5 Form A 1 Form B)

CAD Data

External dimensions

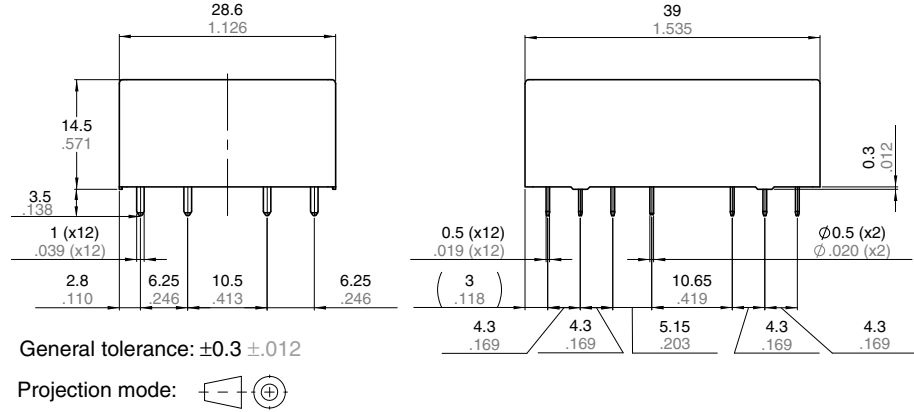

Schematic (Bottom view)

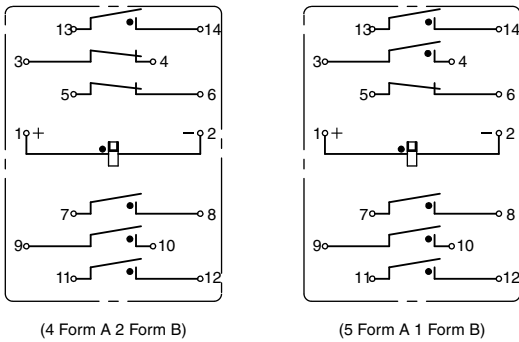

PC board pattern (Bottom view)

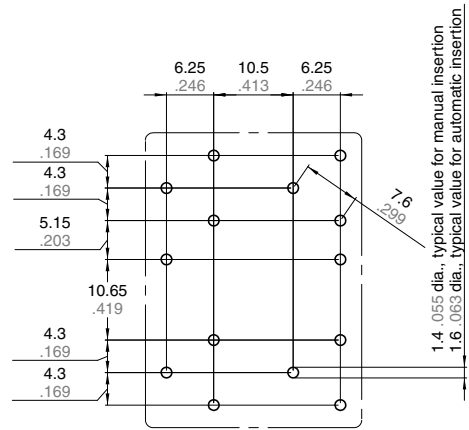

Tolerance:  $\pm 0.1 \pm 0.004$

SAFETY STANDARDS

Certification authority	File No.	Rating
UL/C-UL	E120782*	6A 250V AC, general use, 100Kops 6A 30V DC, general use, 100Kops, B300, R300 (pilot duty)
TÜV	Cert. no: 968/EZ 535. 00/12	6A 230V AC (cosφ=1.0) 70°C 158°F resistive, 6A 24V DC (cosφ=1.0) resistive

\* CSA standard certified by C-UL

NOTES

- 1. For cautions for use, please read "General Application Guidelines" on page B-1.**
- 2. Coil operating power**  
Pure DC current should be applied to the coil. The wave form should be rectangular. If it includes ripple, the ripple factor should be less than 5%. However, check it with the actual circuit since the characteristics may be slightly different.

- 3. Coil connection**  
When connecting coils, refer to the wiring diagram to prevent mis-operation or malfunction.
- 4. Soldering**  
When using automatic soldering, the following conditions are recommended  
 1) Preheating: 120°C 248°F, within 120 sec (PC board solder surface)  
 2) Soldering: 260°C±5°C 500°F±41°F, within 6 sec