



**Compact DIP type SSR**  
**Ideal for AC load control**

AQ-H RELAYS

### FEATURES

1. Supports 0.3 A, 0.6 A, 0.9 A and 1.2 A ON-state RMS currents.
2. The 1.2 A type saves space with a DIP 8-pin package.

4. High dielectric strength: 5,000 V AC (between input and output)
5. Two types available: Zero-cross type and Random type

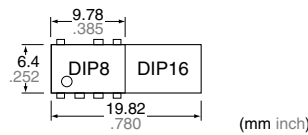
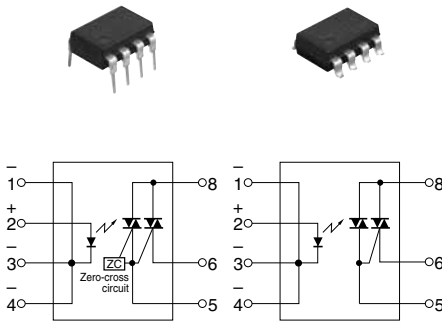

3. Handles both 100 and 200 V AC loads

This relay handles both voltages in a single product. It is not necessary for users that use both types to manage separate part numbers.

### TYPICAL APPLICATIONS

1. Home appliances (air conditioner, microwave oven, washing machine, personal hygiene system, refrigerator, fan heater, inductive heating cooker, rice cooker and humidifier, etc.)
2. Industrial equipment

RoHS compliant

### TYPES

Type	Output rating*		Type	Part No.				Packing quantity	
				Through hole terminal	Surface-mount terminal			Tube	Tape and reel
	Repetitive peak OFF-state voltage	ON-state RMS current			Tube packing style	Tube packing style	Tape and reel packing style		
AC type	600 V	0.3 A	Zero-cross	AQH0213	AQH0213A	AQH0213AX	AQH0213AZ	1 tube contains 50 pcs. 1 batch contains 500 pcs.	1,000 pcs.
				AQH1213	AQH1213A	AQH1213AX	AQH1213AZ		
				AQH2213	AQH2213A	AQH2213AX	AQH2213AZ		
				AQH3213	AQH3213A	AQH3213AX	AQH3213AZ		
		0.6 A	Random	AQH0223	AQH0223A	AQH0223AX	AQH0223AZ		
				AQH1223	AQH1223A	AQH1223AX	AQH1223AZ		
				AQH2223	AQH2223A	AQH2223AX	AQH2223AZ		
				AQH3223	AQH3223A	AQH3223AX	AQH3223AZ		
				AQH0223	AQH0223A	AQH0223AX	AQH0223AZ		
				AQH1223	AQH1223A	AQH1223AX	AQH1223AZ		

\* Indicate the repetitive peak OFF-state voltage and ON-state RMS current: peak AC.  
Note: For space reasons, the SMD terminal shape indicator "A" and the package type indicator "X" and "Z" are omitted from the seal.

### RATING

#### 1. Absolute maximum ratings (Ambient temperature: 25°C 77°F)

Item	Symbol	AQH0213, AQH0223	AQH1213, AQH1223	AQH2213, AQH2223	AQH3213, AQH3223	Remarks	
Input	LED forward current	I <sub>F</sub>				50 mA	
	LED reverse voltage	V <sub>R</sub>				6 V	
	Peak forward current	I <sub>FP</sub>				1 A	f = 100 Hz, Duty Ratio = 0.1%
Output	Repetitive peak OFF-state voltage	V <sub>DRM</sub>				600 V	
	ON-state RMS current	I <sub>T(RMS)</sub>	0.3 A	0.6 A	0.9 A	1.2 A	
	Non-repetitive surge current	I <sub>TSM</sub>	3 A	6 A	9 A	12 A	60Hz, 1 cycle
I/O isolation voltage	V <sub>iso</sub>					5,000 V AC	
Operating temperature	T <sub>opr</sub>					-30°C to +85°C -22°F to +185°F	Non-condensing at low temperatures
Storage temperature	T <sub>stg</sub>					-40°C to +125°C -40°F to +257°F	

Note: "A", "AX" and "AZ" at the end of the part numbers have been omitted.

2. Characteristics (Ambient temperature: 25°C 77°F)

Item		Symbol	AQH0213, AQH1213, AQH2213, AQH3213	AQH0223, AQH1223, AQH2223, AQH3223	Remarks
Input	LED dropout voltage	Typical	V <sub>F</sub>	1.21 V	I <sub>F</sub> = 20 mA
		Maximum		1.3 V	
	LED reverse current	Typical	I <sub>R</sub>	—	V <sub>R</sub> = 6 V
		Maximum		10 μA	
	Peak OFF-state current	Typical	I <sub>DRM</sub>	—	I <sub>F</sub> = 0 mA V <sub>DRM</sub> = 600 V
		Maximum		100 μA	
Output	Peak ON-state voltage	Typical	V <sub>TM</sub>	—	I <sub>F</sub> = 10 mA I <sub>TM</sub> = Max.
		Maximum		2.5 V	
	Holding current	Typical	I <sub>H</sub>	—	
		Maximum		25 mA	
	Critical rate of rise of OFF-state voltage	Minimum	dv/dt	200 V/μs	V <sub>DRM</sub> = 600 V × 1/√2
Transfer characteristics	Trigger LED current	Maximum	I <sub>FT</sub>	10 mA	V <sub>O</sub> = 6 V R <sub>L</sub> = 100 Ω
	Zero-cross voltage	Maximum	V <sub>ZC</sub>	50 V	I <sub>F</sub> = 10 mA
	Turn on time*	Maximum	T <sub>ON</sub>	100 μs	I <sub>F</sub> = 20 mA V <sub>O</sub> = 6 V R <sub>L</sub> = 100 Ω
	I/O isolation resistance	Minimum	R <sub>iso</sub>	50 GΩ	500 V DC

Notes: 1. For type of connection, see page 4.  
2. "A", "AX" and "AZ" at the end of the part numbers have been omitted.

\*Turn on time

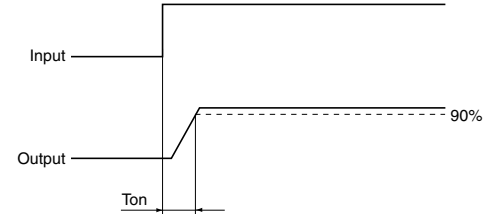

RECOMMENDED OPERATING CONDITIONS

Please follow the conditions below in order to ensure accurate operation and release of the phototriac coupler.

Item	Symbol	Value	Unit
Input LED current	I <sub>F</sub>	20	mA

REFERENCE DATA

1. ON-state RMS current vs. Ambient temperature characteristics

Allowable ambient temperature: -30°C to +85°C -22°F to +185°F

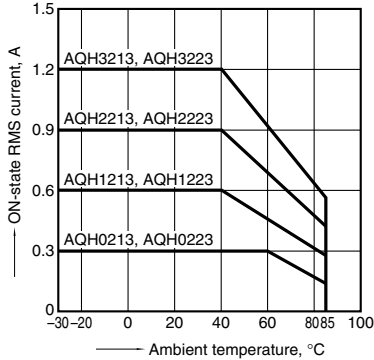

2. Peak ON-state voltage vs. Ambient temperature characteristics

LED current: 10 mA; ON current: Max. Measured portion: between terminals 6 and 8

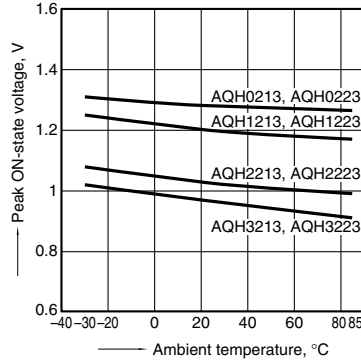

3. Trigger LED current vs. Ambient temperature characteristics

Load voltage: 6 V DC; Load resistance: 100Ω

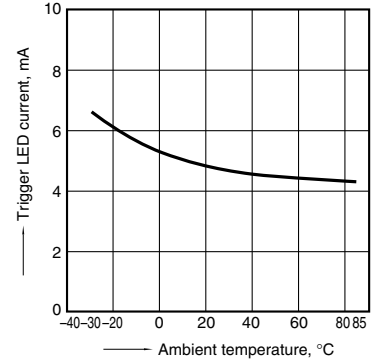

4. LED dropout voltage vs. Ambient temperature characteristics

LED current: 10 to 50 mA

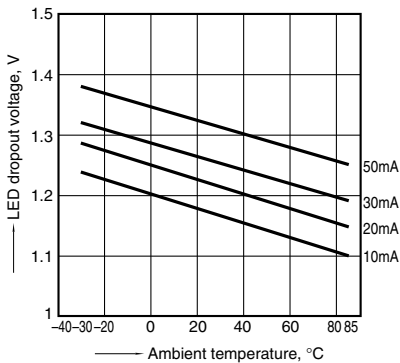

5. Turn on time vs. LED current characteristics

Load voltage: 6 V DC; Load resistance: 100Ω Measured portion: between terminals 6 and 8

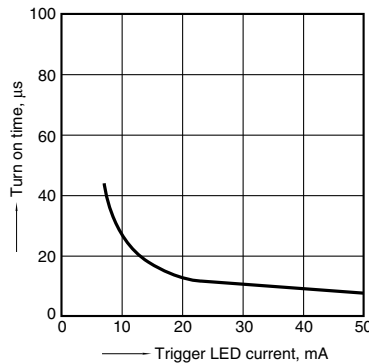

6. Repetitive peak OFF-state current vs. Load voltage characteristics

Ambient temperature: 25°C 77°F; Measured portion: between terminals 6 and 8; LED current: 0 mA

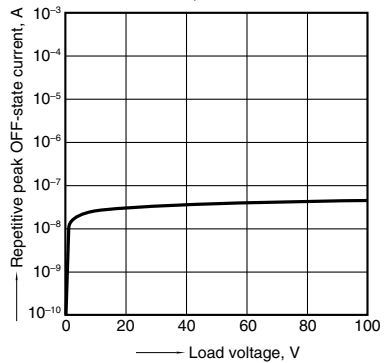

7. Hold current vs. Ambient temperature characteristics

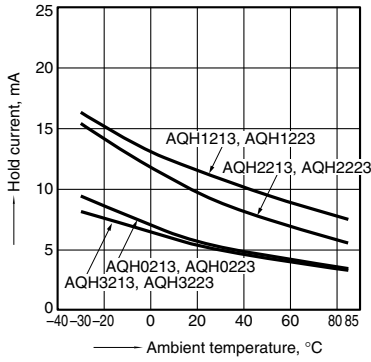

8. Zero-cross voltage vs. Ambient temperature characteristics

LED current: 10 mA

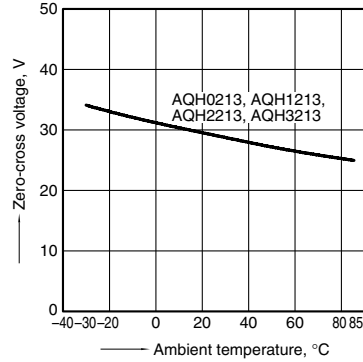

**DIMENSIONS** (mm inch)

The CAD data of the products with a **CAD Data** mark can be downloaded from: <http://industrial.panasonic.com/ac/e/>

**Through hole terminal type**

**CAD Data**

External dimensions

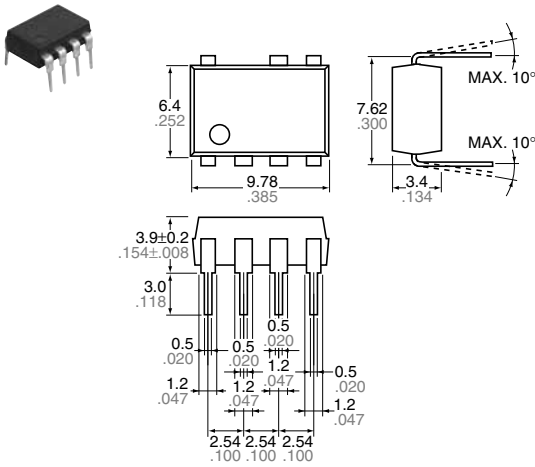

Terminal thickness: 0.25 .010  
General tolerance:  $\pm 0.1 \pm .004$

PC board pattern (BOTTOM VIEW)

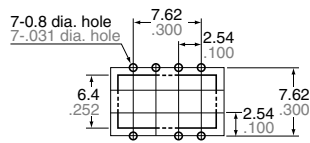

Tolerance:  $\pm 0.1 \pm .004$

**Surface mount terminal type**

**CAD Data**

External dimensions

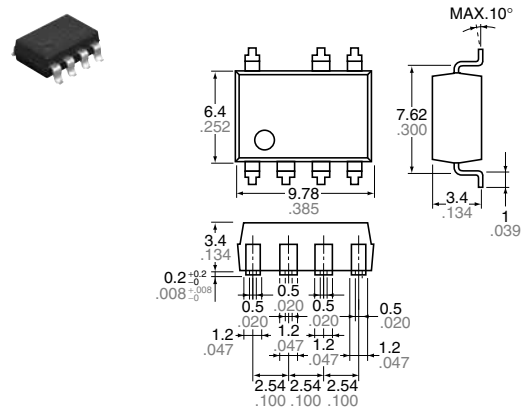

Terminal thickness: 0.25 .010  
General tolerance:  $\pm 0.1 \pm .004$

Recommended mounting pad (TOP VIEW)

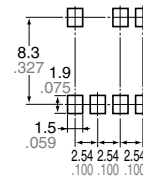

Tolerance:  $\pm 0.1 \pm .004$

# SCHEMATIC AND WIRING DIAGRAMS

Notes:  $E_1$ : Power source at input side;  $I_F$ : Trigger LED forward current;  $V_L$ : Load voltage;  $I_L$ : Load current

Schematic	Output configuration	Load	Wiring diagram
<p>10 + 20 - 30 - 40</p> <p>Zero-cross circuit</p> <p>8 6 5</p>	<p>1a</p>	<p>AC</p>	<p>10 20 30 40</p> <p><math>E_1</math> <math>I_F</math></p> <p>8 6 5</p> <p>Load</p> <p><math>I_L</math> <math>V_L</math> (AC)</p> <p><math>I_L</math> <math>V_L</math> (AC)</p> <p>Load</p>
<p>10 + 20 - 30 - 40</p> <p>Zero-cross circuit</p> <p>8 6 5</p>			