

TV-10/TV-15 rated 1a 30A, 2a 20A power relays

HE RELAYS



1 Form A Plug-in type

RoHS compliant

FEATURES

1. Excellent resistance to contact welding

Owing to the pre-tension and kick-off mechanism, the 1 Form A passes TV-15 and the 2 Form A passes TV-10.

2. High-capacity and long life

Contact arrangement	1 Form A type	2 Form A type
Contact capacity	30A	20A
Electrical life (at 20 times/min.)	2×10 ⁵	
Mechanical life (at 180 times/min.)	DC type: 10 ⁷ , AC type: 5×10 ⁶	

3. Excellent surge resistance

Between contacts and coil, the surge voltage is more than 10,000 V (when surge waveform accords with JEC-212-1981).

4. Compatible with all major safety standards

UL, CSA, VDE and TÜV certified

5. Terminals are available

TYPICAL APPLICATIONS

1. Office equipment

Copiers, package air conditioners, automatic vending machines.

2. Industrial equipment

Machine tools, molding equipment, wrapping machines, food processing equipment, etc.

3. Home appliances

Air conditioners, microwave ovens, televisions, stereo systems, water heaters and air heating equipment.

Type	Single side stable type	
	HE 1 Form A, 2 Form A	
Insulation gap	Min. 8 mm	
Distance between contacts*	1 Form A and 2 Form A: Min. 3 mm	PC board type: Min. 2.5 mm
Breakdown voltage	Between open contacts	2, 000 Vrms for 1 min.
	Between contact and coil	5, 000 Vrms for 1 min.

* Reference value

CLASSIFICATION

Type	PC board	Plug-in		TM		Screw terminal	
Operating function	Single side stable						
Contact arrangement	1 Form A	1 Form A	2 Form A	1 Form A	2 Form A	1 Form A	2 Form A

ORDERING INFORMATION

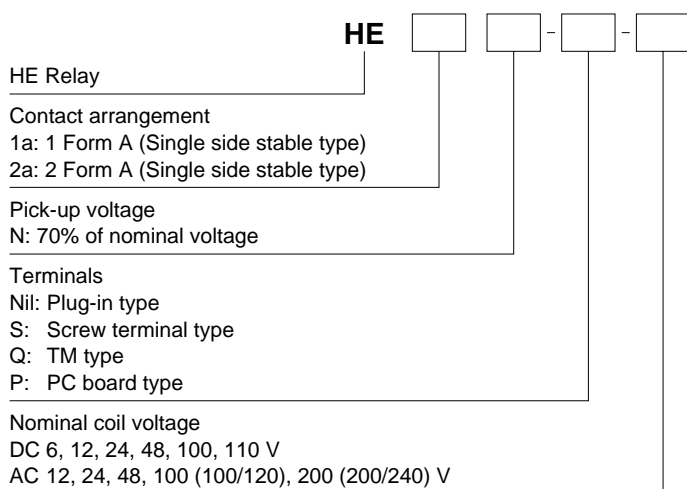

HE

TYPES

1. PC board type (1 Form A, DC coil) (Single side stable)

Nominal coil voltage	1 Form A
	Part No.
6V DC	HE1aN-P-DC6V
12V DC	HE1aN-P-DC12V
24V DC	HE1aN-P-DC24V
48V DC	HE1aN-P-DC48V
100V DC	HE1aN-P-DC100V
110V DC	HE1aN-P-DC110V

Standard packing: Carton: 25 pcs.; Case: 100 pcs.

2. Plug-in type (Single side stable)

Type	Nominal coil voltage	1 Form A	2 Form A
		Part No.	Part No.
DC type	6V DC	HE1aN-DC6V	HE2aN-DC6V
	12V DC	HE1aN-DC12V	HE2aN-DC12V
	24V DC	HE1aN-DC24V	HE2aN-DC24V
	48V DC	HE1aN-DC48V	HE2aN-DC48V
	100V DC	HE1aN-DC100V	HE2aN-DC100V
	110V DC	HE1aN-DC110V	HE2aN-DC110V
AC type	12V AC	HE1aN-AC12V	HE2aN-AC12V
	24V AC	HE1aN-AC24V	HE2aN-AC24V
	48V AC	HE1aN-AC48V	HE2aN-AC48V
	100/120V AC	HE1aN-AC100V	HE2aN-AC100V
	200/240V AC	HE1aN-AC200V	HE2aN-AC200V

Standard packing: Carton: 20 pcs.; Case: 100 pcs.

3. TM type (Single side stable)

Type	Nominal coil voltage	1 Form A	2 Form A
		Part No.	Part No.
DC type	6V DC	HE1aN-Q-DC6V	HE2aN-Q-DC6V
	12V DC	HE1aN-Q-DC12V	HE2aN-Q-DC12V
	24V DC	HE1aN-Q-DC24V	HE2aN-Q-DC24V
	48V DC	HE1aN-Q-DC48V	HE2aN-Q-DC48V
	100V DC	HE1aN-Q-DC100V	HE2aN-Q-DC100V
	110V DC	HE1aN-Q-DC110V	HE2aN-Q-DC110V
AC type	12V AC	HE1aN-Q-AC12V	HE2aN-Q-AC12V
	24V AC	HE1aN-Q-AC24V	HE2aN-Q-AC24V
	48V AC	HE1aN-Q-AC48V	HE2aN-Q-AC48V
	100/120V AC	HE1aN-Q-AC100V	HE2aN-Q-AC100V
	200/240V AC	HE1aN-Q-AC200V	HE2aN-Q-AC200V

Standard packing: Carton: 20 pcs.; Case: 100 pcs.

4. Screw terminal type (Single side stable)

Type	Nominal coil voltage	1 Form A	2 Form A
		Part No.	Part No.
DC type	6V DC	HE1aN-S-DC6V	HE2aN-S-DC6V
	12V DC	HE1aN-S-DC12V	HE2aN-S-DC12V
	24V DC	HE1aN-S-DC24V	HE2aN-S-DC24V
	48V DC	HE1aN-S-DC48V	HE2aN-S-DC48V
	100V DC	HE1aN-S-DC100V	HE2aN-S-DC100V
	110V DC	HE1aN-S-DC110V	HE2aN-S-DC110V
AC type	12V AC	HE1aN-S-AC12V	HE2aN-S-AC12V
	24V AC	HE1aN-S-AC24V	HE2aN-S-AC24V
	48V AC	HE1aN-S-AC48V	HE2aN-S-AC48V
	100/120V AC	HE1aN-S-AC100V	HE2aN-S-AC100V
	200/240V AC	HE1aN-S-AC200V	HE2aN-S-AC200V

Standard packing: Carton: 10 pcs.; Case: 50 pcs.

Note: The TM type of the screw terminals are also available.

* For terminal sockets, see page 198.

RATING

1. Coil data

1) AC coils

Nominal coil voltage	Pick-up voltage (at 20°C 68°F)	Drop-out voltage (at 20°C 68°F)	Nominal operating current [±10%] (at 20°C 68°F)	Nominal operating power	Max. applied voltage (at 20°C 68°F)
12V AC	70%V or less of nominal voltage (Initial)	15%V or more of nominal voltage (Initial)	138mA	1.7VA	110%V of nominal voltage
24V AC			74mA	1.8VA	
48V AC			39mA	1.9VA	
100/120V AC			18.7 to 2.1mA	1.9 to 2.7VA	
200/240V AC			9.1 to 10.8mA	1.8 to 2.6VA	

2) DC coils

Nominal coil voltage	Pick-up voltage (at 20°C 68°F)	Drop-out voltage (at 20°C 68°F)	Nominal operating current [±10%] (at 20°C 68°F)	Coil resistance [±10%] (at 20°C 68°F)	Nominal operating power	Max. applied voltage (at 55°C 131°F)
6V DC	70%V or less of nominal voltage (Initial)	10%V or more of nominal voltage (Initial)	320mA	18.8Ω	1.92W	110%V of nominal voltage
12V DC			160mA	75Ω	1.92W	
24V DC			80mA	300Ω	1.92W	
48V DC			40mA	1,200Ω	1.92W	
100V DC			19mA	5,200Ω	1.92W	
110V DC			18mA	6,300Ω	1.92W	

2. Specifications

Characteristics	Item	Specifications	
Contact	Contact material	AgSnO ₂ type	
	Arrangement	1 Form A 2 Form A	
	Contact resistance (Initial)	Max. 100 mΩ (By voltage drop 6 V DC 1A)	
Rating	Nominal switching capacity (resistive load)	30A 277V AC 25A 277V AC	
	Max. switching power	8,310VA 6,925VA	
	Max. switching voltage	277V AC, 30V DC	
	Max. switching current	30A 25A	
	Nominal operating power	DC: 1.92W, AC: 1.7 to 2.7VA	
	Min. switching capacity (Reference value)*1	100mA 5V DC	
Electrical characteristics	Insulation resistance (Initial)	Min. 1,000MΩ (at 500V DC) Measurement at same location as "Breakdown voltage" section.	
	Breakdown voltage (Initial)	Between open contacts	2,000 Vrms for 1min (Detection current: 10mA.)
		Between contact sets	—
		Between contact and coil	5,000 Vrms for 1min (Detection current: 10mA.)
	Temperature rise (coil)	DC: Max. 60°C (at 55°C) (By resistive method), AC: Max. 65°C (at 55°C) (By resistive method)	
	Surge breakdown voltage*2 (between contact and coil) (Initial)	Min. 10,000V	
Mechanical characteristics	Shock resistance	Functional	Min. 98 m/s ² (Half-wave pulse of sine wave: 11 ms; detection time: 10μs.)
		Destructive	Min. 980 m/s ² (Half-wave pulse of sine wave: 6 ms.)
	Vibration resistance	Functional	10 to 55 Hz at double amplitude of 1 mm (Detection time: 10μs.)
		Destructive	10 to 55 Hz at double amplitude of 1.5 mm
Expected life	Mechanical	DC: Min. 10 ⁷ (at 180 times/min.), AC: Min. 5×10 ⁶ (at 180 times/min.)	
	Electrical (resistive load) (at 20 times/min.)	Min. 10 ⁵ (30A 277V AC) Min. 10 ⁵ (25A 277V AC) Min. 2×10 ⁵ (30A 250V AC) Min. 2×10 ⁵ (20A 250V AC)	
Conditions	Conditions for operation, transport and storage*3	Ambient temperature: -50°C to +55°C -58°F to +131°F Humidity: 5 to 85% R.H. (Not freezing and condensing at low temperature), Air pressure: 86 to 106kPa	
	Max. operating speed	20 times/min. (at max. rating)	
Unit weight		PC board type: approx. 80g 2.82oz, Plug-in type/TM type: approx. 90g 3.17oz, Screw terminal type: approx. 120g 4.23oz	

Notes: *1. This value can change due to the switching frequency, environmental conditions, and desired reliability level, therefore it is recommended to check this with the actual load.

*2. Wave is standard shock voltage of ±1.2×50μs according to JEC-212-1981

*3. The upper limit of the ambient temperature is the maximum temperature that can satisfy the coil temperature rise value. Refer to Usage, transport and storage conditions in NOTES.

REFERENCE DATA

1 Form A Type

1. Maximum switching power



2. Life curve



3. Coil temperature rise (DC type)

Measured portion: Inside the coil
Contact current: 30 A

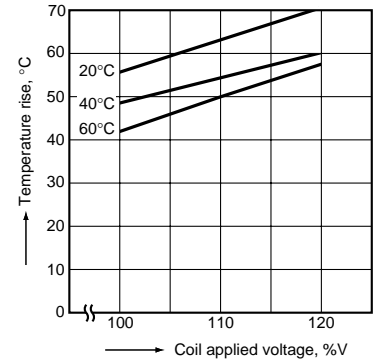

4. Ambient temperature characteristics

Tested sample: HE1aN-AC120V, 6 pcs.



2 Form A Type

1. Maximum switching power



2. Life curve

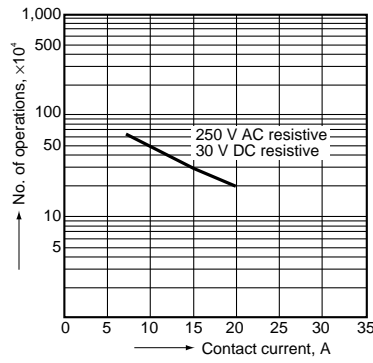

3. Coil temperature rise (DC type)

Measured portion: Inside the coil
Contact current: 30 A

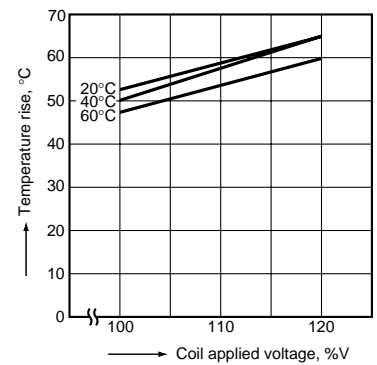

4. Ambient temperature characteristics

Tested sample: HE2aN-AC120V, 6 pcs.



DIMENSIONS (mm inch)

The CAD data of the products with a **CAD Data** mark can be downloaded from: <http://industrial.panasonic.com/ac/e/>

1. PC board type

1 Form A

CAD Data

External dimensions
Single side stable type



General tolerance: $\pm 0.3 \pm 0.012$

Schematic (Bottom view)
Single side stable type



PC board pattern (Bottom view)

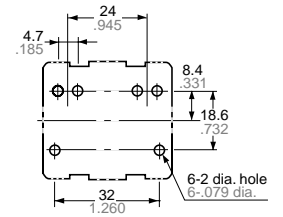

Tolerance: $\pm 0.1 \pm 0.004$

2. Plug-in type

1 Form A

CAD Data

External dimensions
Single side stable type



General tolerance: $\pm 0.3 \pm 0.012$

Schematic (Bottom view)
Single side stable type

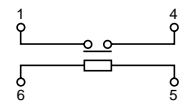

Panel cutout

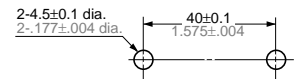

Tolerance: $\pm 0.1 \pm 0.004$

2 Form A

CAD Data

External dimensions
Single side stable type



General tolerance: $\pm 0.3 \pm 0.012$

Schematic (Bottom view)
Single side stable type

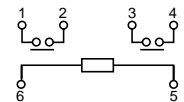

Panel cutout

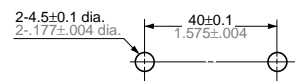

Tolerance: $\pm 0.1 \pm 0.004$

3. TM type

CAD Data

External dimensions
Single side stable type

1 Form A

2 Form A

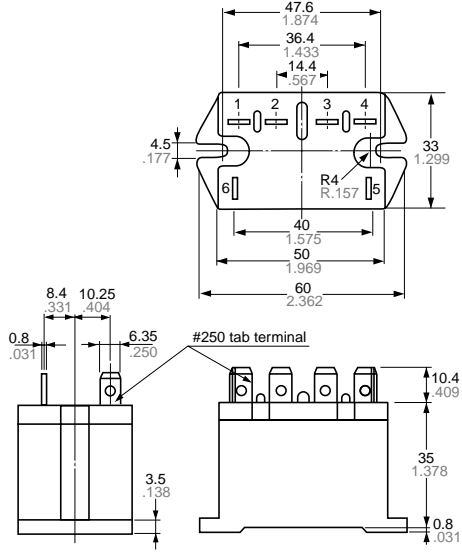
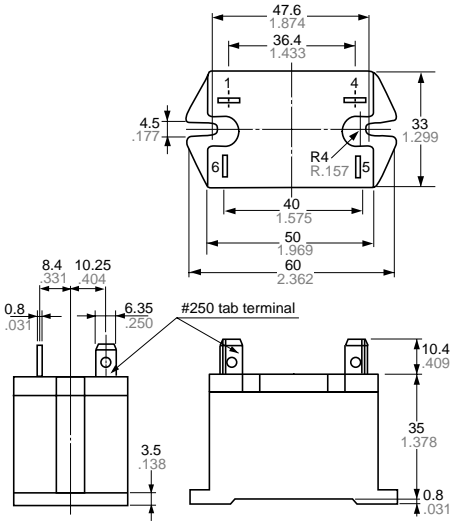

Schematic (Bottom view)
Single side stable type

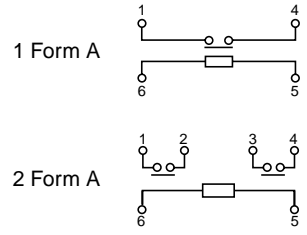

Panel cutout

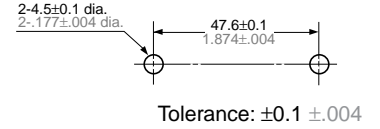

General tolerance: $\pm 0.3 \pm .012$

4. Screw terminal type

1 Form A

CAD Data

External dimensions
Single side stable type

Schematic (Bottom view)
Single side stable type

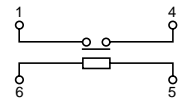
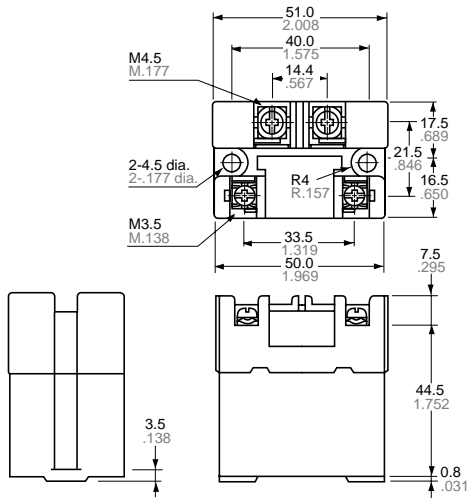

Panel cutout

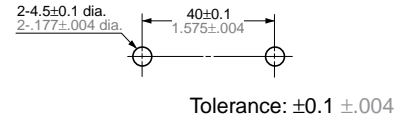

General tolerance: $\pm 0.3 \pm .012$

2 Form A

CAD Data

External dimensions
Single side stable type

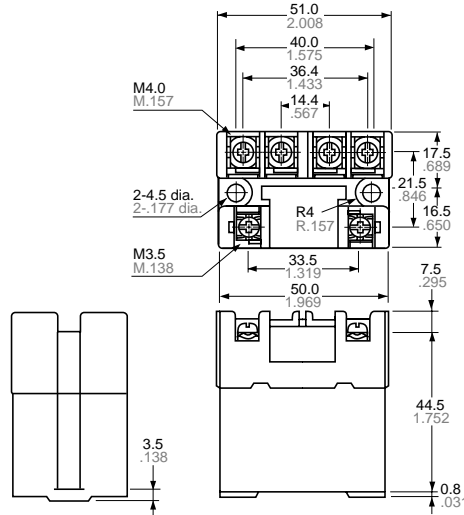

General tolerance: $\pm 0.3 \pm 0.12$

Schematic (Bottom view)
Single side stable type

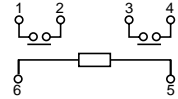

Panel cutout

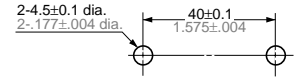

Tolerance: $\pm 0.1 \pm 0.04$

MOUNTING METHOD

1. Plug-in type

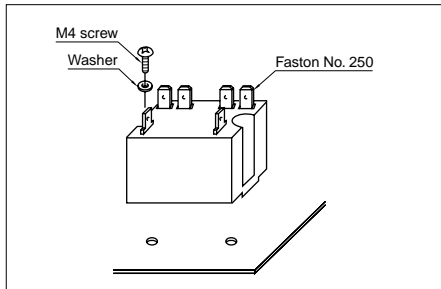

2. Screw terminal type

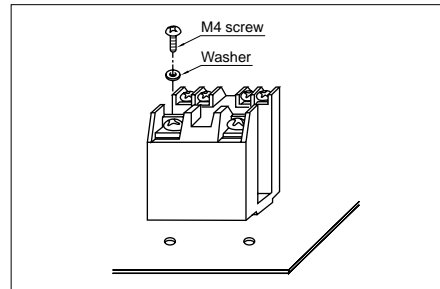

3. Allowable installation wiring size for screw terminal types and terminal sockets

Due to the UP terminals, it is possible to either directly connect the wires or use crimped terminal.

SAFETY STANDARDS

Item	UL/C-UL (Recognized)		CSA (Certified)		VDE (Certified)		TV rating (UL/CSA)		TÜV (Certified)	
	File No.	Contact rating	File No.	Contact rating	File No.	Contact rating	File No.	Rating	File No.	Rating
1 Form A	E43028	30A 277V AC 30A 30V DC 1.5HP 125V AC 3HP 250V AC	LR26550 etc.	30A 277V AC 30A 30V DC 1.5HP 125V AC 3HP 250V AC	40006681	30A 250V AC (cosφ=1.0) 30A 250V AC (cosφ=0.4) 5A 110V DC (0ms)	UL E43028	TV-15	B 11 04 13461 293	30A 250V AC (cosφ=1.0) 30A 250V AC (cosφ=0.4) 8A 110V DC (0ms)
2 Form A	E43028	25A 277V AC 25A 30V DC 1HP 125V AC 2HP 250V AC	LR26550 etc.	25A 277V AC 25A 30V DC 1HP 125V AC 2HP 250V AC	40006681	25A 250V AC (cosφ=1.0) 25A 250V AC (cosφ=0.4) 5A 110V DC (0ms)	UL E43028	TV-10	B 11 04 13461 293	25A 250V AC (cosφ=1.0) 25A 250V AC (cosφ=0.4) 8A 110V DC (0ms)

NOTES

- The dust cover should not be removed since doing so may alter the characteristics.
- Avoid use under severe environmental conditions, such as high humidity, organic gas or in dust, oily locations and locations subjected to extremely frequent shock or vibrations.
- When mounting, use spring washers. Optimum fastening torque ranges from 49 to 68.6 N·m (5 to 7 kgf·cm).

- Firmly insert the receptacles so that there is no slack or looseness. To remove a receptacle, 19.6 to 39.2 N (2 to 4 kg) of pulling strength is required. Do not remove more than one receptacle at one time. Always remove one receptacle at a time and pull it straight outwards.
- When using the AC type, the operate time due to the in-rush phase is 20 ms or more. Therefore, it is necessary for you to verify the characteristics for your actual circuit.

- When using the push-on blocks for the screw terminal type, use crimped terminals and tighten the screw-down terminals to the torque below.
M4.5 screw:
147 to 166.6 N·cm (15 to 17 kgf·cm)
M4 screw:
117.6 to 137 N·cm (12 to 14 kgf·cm)
M3.5 screw:
78.4 to 98 N·cm (8 to 10 kgf·cm)

For Cautions for Use.