

**Load current 10 to 25A  
Small Tab Terminal SSR**

# AQ-J RELAYS

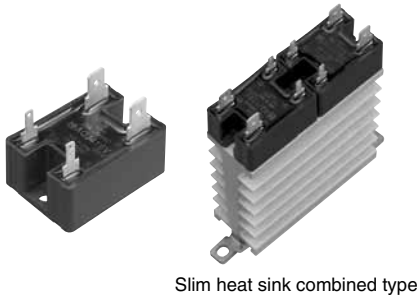

Slim heat sink combined type

**RoHS compliant**

### FEATURES

- Compact Size**  
W 28 × L 38 × H 30 mm  
W 1.102 × L 1.496 × H 1.181 inch
- Built-in varistor**
- Reverse input connection prevention function**
- Labor Saving (tab terminal)**
- Heat sink combined types ready to mount on DIN rail added (Radiating grease and screws assembly process not needed)**
- Output arrangement 1a and 1a × 2 available in the heat sink combined type**

Note: \* International standards are acquired for AQ-J SSR stand-alone, not applied to heat sink combined type.

### TYPICAL APPLICATIONS

- Kitchen appliances**
- Vending machine**
- Injection molding machine**
- Packing machine**
- Amusement machine**

## ORDERING INFORMATION

AQJ

#### Output type

- 1: 10A, 75V to 264V AC
- 2: 15A, 75V to 264V AC
- 4: 25A, 75V to 264V AC

#### Terminal, Type

- 1: Tab terminal, Zero-cross
- 2: Tab terminal, Random\*

#### Input voltage

- 2: 4 to 6 V DC
- 6: 18 to 28 V DC
- 9: 10 to 18 V DC

#### Functions

- V: Built-in varistor

#### Slim heat sink combined type

- None: Without a heat sink
- Y: 1a type
- W: 1a × 2 type

Note: \* Random type is available by custom order.

## TYPES

### 1. AQ-J Solid State Relays

Type	Load current	Load voltage	Input voltage	Part No.
Zero-cross*	10A	75V to 264V AC	4 to 6V DC	AQJ112V
			10 to 18V DC	AQJ119V
			18 to 28V DC	AQJ116V
	15A		4 to 6V DC	AQJ212V
			10 to 18V DC	AQJ219V
			18 to 28V DC	AQJ216V
	25A		4 to 6V DC	AQJ412V
			10 to 18V DC	AQJ419V
			18 to 28V DC	AQJ416V

Standard Packing: carton: 10 pcs., case: 200 pcs.  
Note: Random type also available. Please inquire.

**2. AQ-J Slim Heat Sink Combined Type**

Output configuration	Type	Load current	Load voltage	Input voltage	Part No.	
1a	Zero-cross*	10A	75V to 264V AC	4 to 6V DC	AQJ112VY	
				10 to 18V DC	AQJ119VY	
				18 to 28V DC	AQJ116VY	
		4 to 6V DC		AQJ412VY		
		10 to 18V DC		AQJ419VY		
		18 to 28V DC		AQJ416VY		
1a x 2		10A (per 1a)		15A (per 1a)	4 to 6V DC	AQJ112VW
					10 to 18V DC	AQJ119VW
					18 to 28V DC	AQJ116VW
		4 to 6V DC		AQJ412VW		
		10 to 18V DC		AQJ419VW		
		18 to 28V DC		AQJ416VW		

Standard Packing; no carton, case: 10 pcs.  
 Note: \* Random type also available. Please inquire.

**3. Accessories**

Type	Part No.	Packaged quantity
Slim heat sink (28mm wide) (Mountable on a DIN rail)	AQP-HS-SJ10A	No carton, 10 in a case
Slim heat sink (45mm wide) (Mountable on a DIN rail)	AQP-HS-SJ20A	No carton, 8 in a case
Standard heat sink (10A and 15A)	AQP-HS-J10A	5 in a carton, 20 in a case
Standard heat sink (25A only)	AQP-HS-J25A	No carton, 5 in a case
DIN rail mounting plate	AQP-DPJ	No carton, 50 in a case
Mounting rail	AT8-DLA1	1 in a carton, 100 in a case
Fastening plate	AT8-DLE	1 in a carton, 200 in a case

**RATING**

**1. Ratings (Test sample: AQ-J stand-alone, Measurement condition: at 20°C 68°F, input ripple: 1% or less)**

1) Input side

Item	Part No.	AQJ112V AQJ212V AQJ412V	AQJ119V AQJ219V AQJ419V	AQJ116V AQJ216V AQJ416V
Rated voltage		5V DC	12V DC	24V DC
Input voltage		4 to 6V DC	10 to 18V DC	18 to 28V DC
Input impedance		Approx. 0.26kΩ	Approx. 0.8kΩ	Approx. 1.6kΩ
Drop-out voltage			Min. 1V DC	

Note: Refer to REFERENCE DATA "3. Input current vs. input voltage characteristics".

2) Output side

Item	Part No.	AQJ112V AQJ119V AQJ116V	AQJ212V AQJ219V AQJ216V	AQJ412V AQJ419V AQJ416V
Max. load current*1		10A	15A	25A
Load voltage		75 to 264V AC		
Frequency		45Hz to 65Hz		
Non-repetitive surge current		100A	150A	250A
"OFF-state" leakage current		Max. 5mA		
"ON-state" voltage drop		Max. 1.6V		
Min. load current*2		50mA		

Notes: \*1. Refer to REFERENCE DATA "1. Load current vs. ambient temperature".

\*2. When the load current is less than the rated minimum load current, please refer to "Cautions for Use".

**2. Ratings (Test sample: AQ-J slim heat sink combined type, Measurement condition: at 20°C 68°F, input ripple: 1% or less)**

1) Input side

Item	Part No.	AQJ112V(Y-W) AQJ412V(Y-W)	AQJ119V(Y-W) AQJ419V(Y-W)	AQJ116V(Y-W) AQJ416V(Y-W)
Rated voltage		5V DC	12V DC	24V DC
Input voltage		4 to 6V DC	10 to 18V DC	18 to 28V DC
Input impedance		Approx. 0.26kΩ	Approx. 0.8kΩ	Approx. 1.6kΩ
Drop-out voltage			Min. 1V DC	

Note: Refer to REFERENCE DATA "3. Input current vs. input voltage characteristics".

2) Output side

Item	Part No.	AQJ112VY AQJ119VY AQJ116VY	AQJ412VY AQJ419VY AQJ416VY	AQJ112VW AQJ119VW AQJ116VW	AQJ412VW AQJ419VW AQJ416VW
Output arrangement		1a		1a × 2	
Max. load current*1		10A	20A	10A	15A
Load voltage		75 to 264V AC			
Frequency		45Hz to 65Hz			
Non-repetitive surge current*2		100A	250A	100A	250A
"OFF-state" leakage current		Max. 5mA			
"ON-state" voltage drop		Max. 1.6V			
Min. load current*3		50mA			

Notes: \*1. Refer to REFERENCE DATA "3. Input current vs. input voltage characteristics".  
 \*2. Refer to REFERENCE DATA "1. Load current vs. ambient temperature".  
 \*3. When the load current is less than the rated minimum load current, please refer to "Cautions for Use".

3. Characteristics (Measurement condition: at 20°C 68°F, input ripple: 1% or less)

Item	Characteristics	Remarks
Operate time	Max. 1/2 cycle of voltage sine wave + 1ms	
Release time	Max. 1/2 cycle of voltage sine wave + 1ms	
Insulation resistance	Min. 100MΩ between input, output and case	at 500 V DC
Breakdown voltage	3,000 Vrms between input and output	for 1min.
	2,500 Vrms between input, output and case	
Vibration resistance	SSR stand-alone: 10 to 55Hz, double amplitude of 1.5mm	X, Y, Z axes
	Slim heat sink combined type: 10 to 55Hz, double amplitude of 0.75mm	
Shock resistance	SSR stand-alone: Min. 980m/s <sup>2</sup>	X, Y, Z axes
	Slim heat sink combined type: Min. 197m/s <sup>2</sup>	
Ambient temperature	-30 to +80°C -22 to +176°F	Non-condensing at low temperatures
Storage temperature	-30 to +100°C -22 to +212°F	Non-condensing at low temperatures
Operational method	Zero-cross (Turn ON and Turn OFF)	

REFERENCE DATA

(1) AQ-J Solid State Relays

1. Load current vs. ambient temperature

Tested condition:

- If attached to a heat sink, use a heat conductive compound (Ex. Momentive Performance Materials Inc. YG6111 or TSK5303) of similar coating to improve cooling
- Without external heat sink  
If the mounting surface is not metallic and a heat sink is not used, expose the bottom surface and plate surface to improve heat dissipation.

3) The current value is per 1a.

(A) slim heat sink	AQP-HS-SJ20A
(B) slim heat sink	AQP-HS-SJ10A
(C) standard heat sink	AQP-HS-J10A
(D) DIN rail mounting plate	AQP-DPJ
(E) standard heat sink	AQP-HS-J25A

Use load current within range specified in the figure below

(1) 10 A type (when using heat sink or iron plate)

(2)-1. 15 A type (when using iron plate)

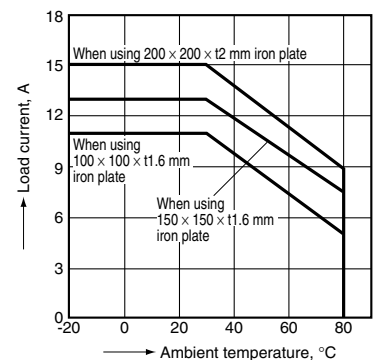
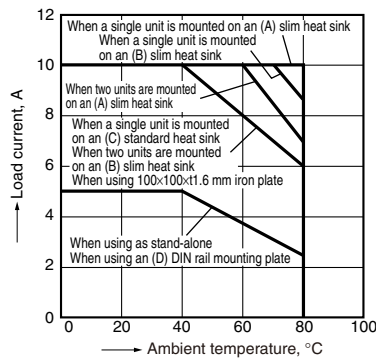

(2)-2. 15 A type (when using a heat sink)

(3)-1. 25 A type (when using iron plate)

(3)-2. 25 A type (when using a heat sink)

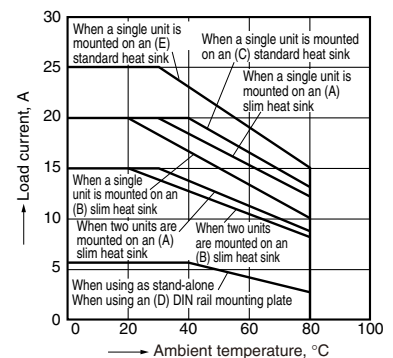
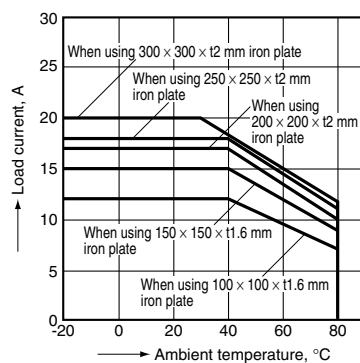
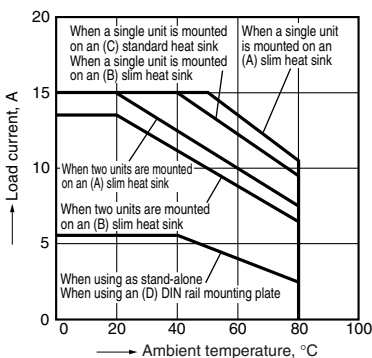

**2. Non-repetitive surge current vs. carrying time**

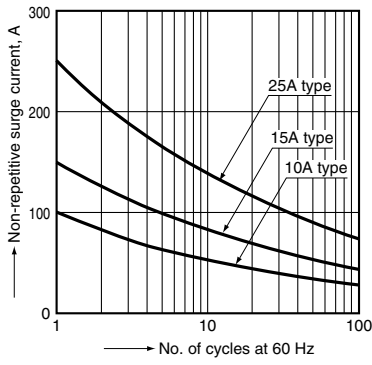

**3. Input current vs. input voltage characteristics**

(10A, 15A and 25A common)

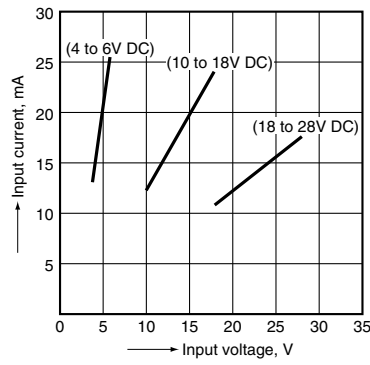

**(2) AQ-J Slim Heat Sink Combined Type**

**1. Load current vs. ambient temperature characteristics**

(1) Output arrangement: 1a

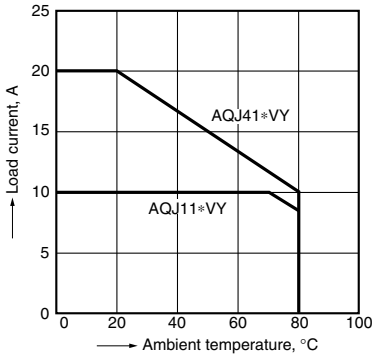

Use load current within range specified in the figure below

(2) Output arrangement: 1a x 2

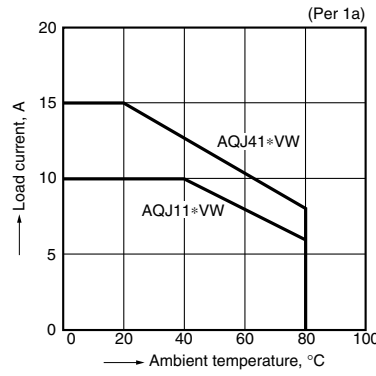

Note:  
When two contacts are operated simultaneously.  
In the case of a single-contact operation, the rating of  
(1) AQJ11\*VY, AQJ41\*VY applies.

**2. Surge current vs. carrying time characteristics**

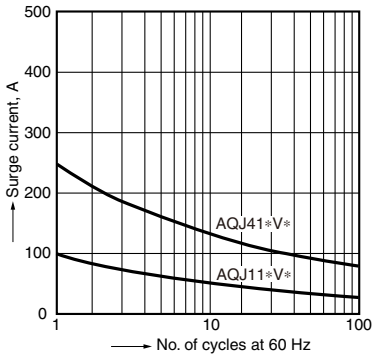

**3. Input current vs. input voltage characteristics**

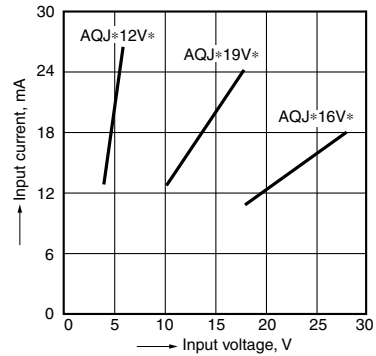

# DIMENSIONS (mm inch)

The CAD data of the products with a **CAD Data** mark can be downloaded from: <http://industrial.panasonic.com/ac/e/>

## 1. AQ-J Stand Alone

**CAD Data**

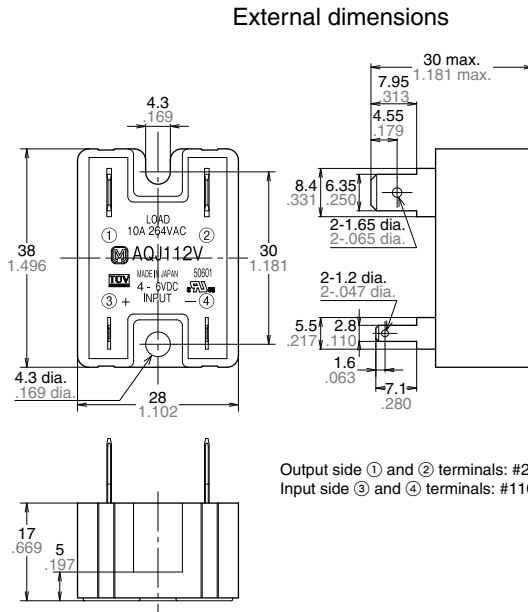

Output side ① and ② terminals: #250 type, t = 0.8 .031  
 Input side ③ and ④ terminals: #110 type, t = 0.5 .020

### Schematic

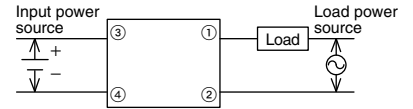

### Mounting dimensions

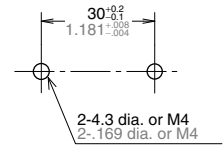

## 2.-(1) AQ-J Slim Heat Sink Combined Type Output Arrangement: 1a

**CAD Data**

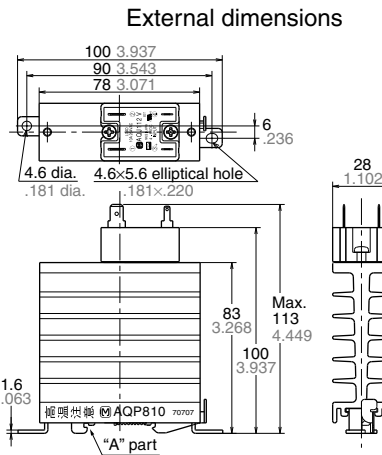
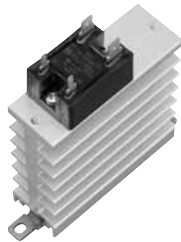

Note: When using on a DIN rail, please install so that the "A" part is on top.

### Schematic

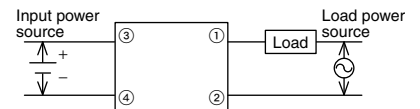

### Mounting dimensions (Top view)

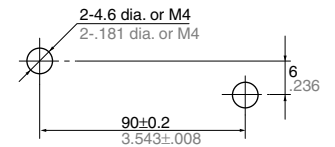

## 2.-(2) AQ-J Slim Heat Sink Combined Type Output Arrangement: 1a x 2

**CAD Data**

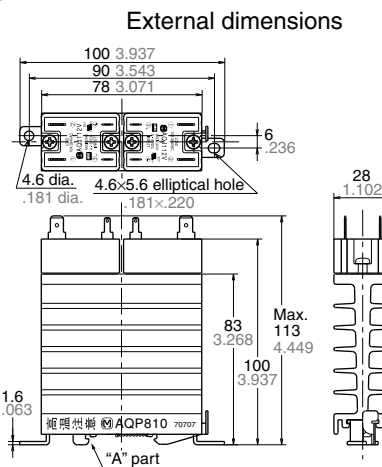
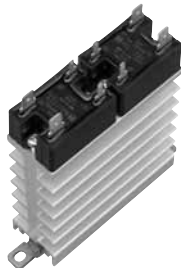

Note: When using on a DIN rail, please install so that the "A" part is on top.

### Schematic

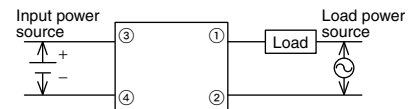

Note: Use caution for AQ-J terminal numbers.

### Mounting dimensions (Top view)

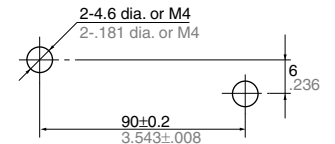

**ACCESSORIES** (mm inch)

**AQP-HS-SJ10A Slim Heat Sink**

**CAD Data**



External dimensions

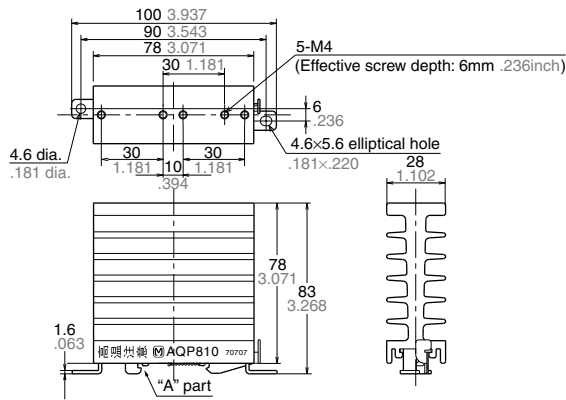

Mounting dimensions (Top view)

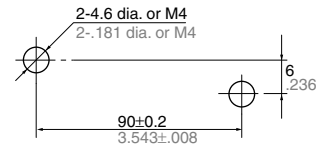

Note: When using on a DIN rail, please install so that the "A" part is on top.

**AQP-HS-SJ20A Slim Heat Sink**

**CAD Data**



External dimensions

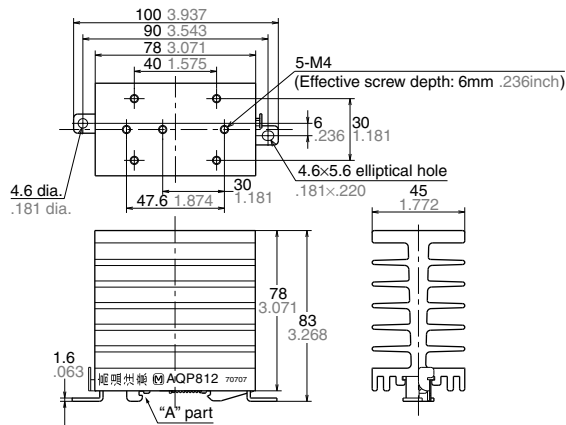

Mounting dimensions (Top view)

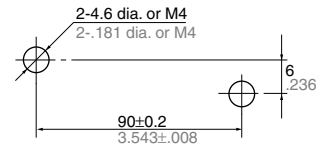

Note: When using on a DIN rail, please install so that the "A" part is on top.

**AQP-HS-J10A Standard Heat Sink (for 10A and 15A types)**

**CAD Data**

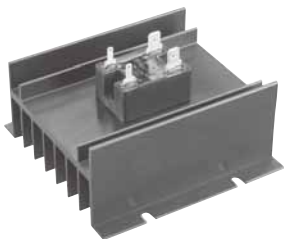

External dimensions

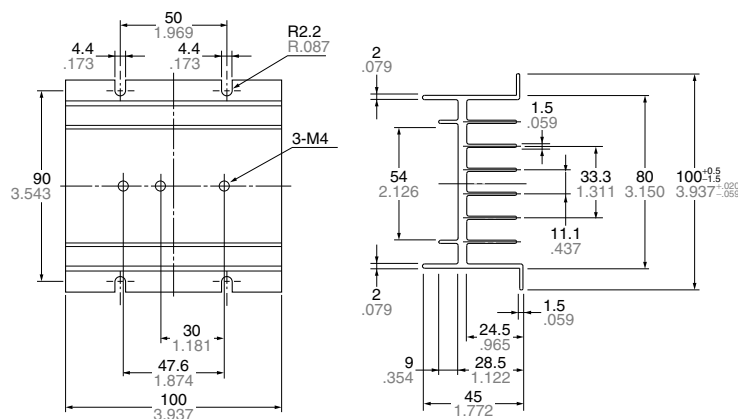

Mounting dimensions

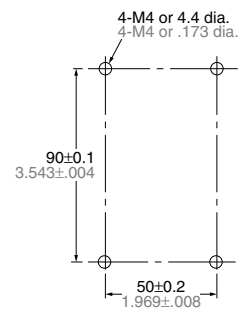

**AQP-HS-J25A Standard Heat Sink  
(for 25A type)**

**CAD Data**



External dimensions

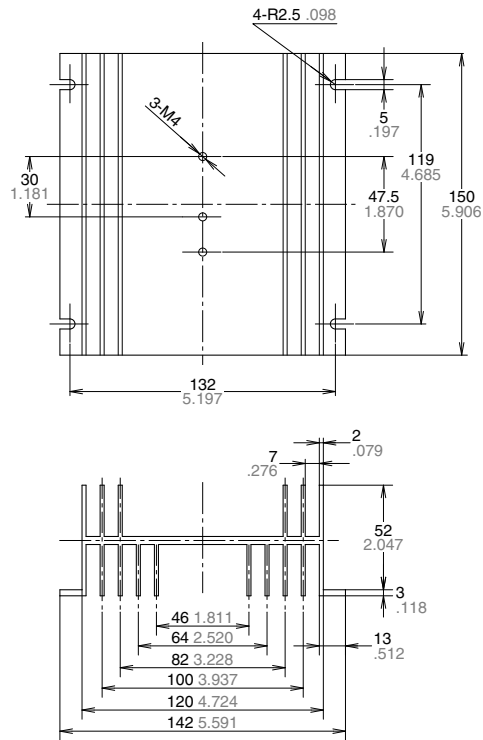

Mounting dimensions

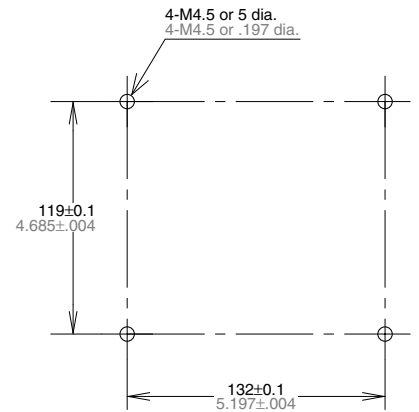

**AQP-DPJ DIN Rail Mounting Plate**

**CAD Data**



External dimensions

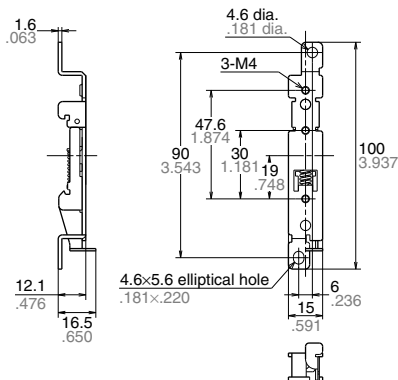

**AT8-DLA1 Mounting rail**

**CAD Data**

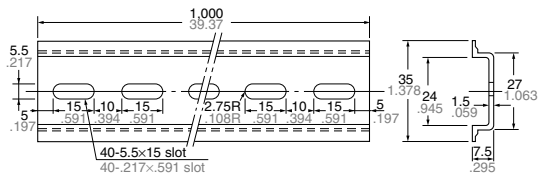

**AT8-DLE Fastening plate**

**CAD Data**

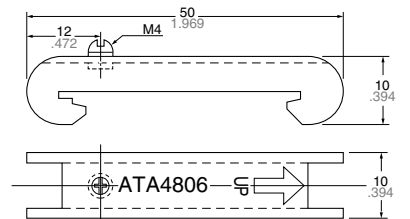

## NOTES

### 1. Part number indication

The AQ-J slim heat sink combined type is a product combining the AQ-J SSR and AQ-J SSR heat sinks. The part numbers are indicated on each AQ-J SSR and heat sink.

Ex) In the case of AQJ112VY

Part number of AQ-J SSR: AQJ112V

Part number of the heat sink: AQP810\*

When using these parts, please refer to REFERENCE DATA, "1. Load current vs. ambient temperature".

Note: \* The Japanese part number is printed on the following accessories in stead of Global part number. Please refer to the below chart for interpretation from Japanese to Global part number.

Products	Japanese Part No.	Global Part No.	Compatible models
Slim heat sink (28 mm)	AQP810	AQP-HS-SJ10A	AQ-J
Slim heat sink (45 mm)	AQP812	AQP-HS-SJ20A	AQ-A, AQ-J
Standard heat sink (10A and 15A)	AQP811	AQP-HS-J10A	AQ-A, AQ-J
Standard heat sink (25A and 40A)	AQP808	AQP-HS-J25A	AQ-A, AQ-J
Standard heat sink (AQ-A 25A)	AQP804	AQP-HS-30/40A	AQ-A
DIN Rail Mounting Plate (for AQ-A and AQ-J)	AQP809	AQP-DPJ	AQ-A, AQ-J
Mounting Rail	ATA48011	AT8-DLA1	AQ-A, AQ-J
Terminal Cover (for AQ-A)	AQA801	AQA801	AQ-A

## Recommended Temperature Controllers



### <KT4H Temperature Controller>

Our temperature controller is recommended for use with our Solid State Relays.

#### Features

- Space saving requiring only a depth of 65 mm
- Data collection possible through a PLC using RS485 communication
- Tool port is standard for easy data setting
- Inverted LCD + backlight for good legibility with large characters
- Excellent operability and rich optional control functions

#### Substitute part numbers

Power supply	Control output	Part No.
100 to 240 V AC	Non-contact voltage output	AKT4H112100

\* For detailed product information about temperature controllers, please refer to our website:  
<http://industrial.panasonic.com/ac/e/>