



Inductors CONTENTS

Classification	Product Item	Type / Series	Part Number	Page		
Fixed Inductors	Chip Inductors	High Freq. Use (Non Magnetic Core)	ELJ RF, RE	2		
		High Freq. Use High-Q (Non Magnetic Core)	ELJ QF, QE	7		
		High Power Type	ELJ PF, PE	12		
		Common specifications		14		
	Voltage Step-up Coils	Chip	ELT 3KN	17		
	Power Inductors	Selection Guide		22		
	Power Inductors / Multilayer type	Magnetic Shielded Type	ELG TEA	23		
	Power Inductors / Wire Wound type	Magnetic Shielded Type (Magnetic Adhesive Type)	ELL YFJ, YGJ	31		
ELL VEG, VFG-C, VGG, VGG-C			33			
ELL 3FU			36			
ELL 4FG-A, 4GG, 4LG-A			38			
ELL SFG-A			40			
ELL 5PS			42			
ELL 5PR			44			
ELL 6GG, 6PG		46				
Magnetic Shielded Type (Ring Core Type)		ELL 6RH, 6SH, 6UH	48			
		ELL 8TP	51			
		ELL ATP	53			
		ELL CTP	55			
Non Magnetic Shielded Type		ELC SFN-A	57			
Common specifications			59			
Choke Coils	Power Choke Coil	PCC-D1413H(DUST) for automotive use	ETQ PDH	61		
		PCC-M0530M/M0540M M0630M/M0645M M0754M/M0854M/M0850M/ M1054M/M1050M/ M1050ML/M1060ML (MC) for automotive use	ETQ P5M	64		
		PCC-M0630L/M0630M(MC) for consumer use	ETQ P3L/3M	73		
		Safety Precautions (Common precautions for Power Choke Coil for high reliability use)			75	
		PCC-M0512W (MC) for consumer use	ETQ P1W	77		
		PCC-M0630W (MC) for consumer use	ETQ P3W	79		
		PCC-M0730L (MC) for consumer use	ETQ P3L	81		
		PCC-M074L(MC) Low DCR Type for consumer use	ETQ P4L	83		
		PCC-M104L(MC) for consumer use	ETQ P4L	85		
		PCC-M104L(MC) Low DCR Type for consumer use	ETQ P4L	87		
		PCC-M104W(MC) for consumer use	ETQ P4W	89		
		PCC-M125L(MC) for consumer use	ETQ P5L	91		
		PCC-D124H(NX1) for consumer use	ETQ P3H	93		
		PCC-D125H(NX2) for consumer use	ETQ P2H	95		
		PCC-D126H(NX3) for consumer use	ETQ P1H	97		
		PCC-D126F(N6B) for consumer use	ETQ P6F	99		
		PCC-F126F(N6) for consumer use	ETQ P6F	101		
		Common specifications		103		
		Choke Coil	Pin terminal common page			107
			Regular Type	ELC 09D, 11D, 12D, 16B, 18B	109	
			Magnetic Shield Type	ELC 10E-L, 12E-L, 15E-L, 18E-L	114	
			Taping/Safety Precautions			118

All products in this catalog comply with the RoHS Directive.

The RoHS Directive is “the Directive (2011/65/EU) on the Restriction of the Use of Certain Hazardous Substances in Electrical and Electronic Equipment ” and its revisions.

Chip Inductors High Frequency Use (Non Magnetic Core)

Type: **ELJRF**
ELJRE



■ Features

- High frequency capability due to its non magnetic core.
- Capable of being Re-flow or flow soldered.
- Unique Ceramic Core/Laser-cut Technology.
- Non polarity product.
- Good for mounting.
- RoHS compliant

■ Recommended Applications

- RF circuitry for cellular phones and wireless communication equipment.

■ Explanation of Part Numbers

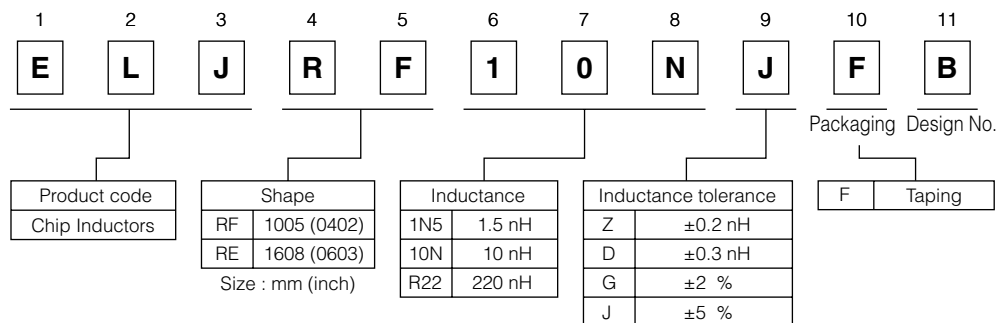

■ Storage Conditions

- Package : Normal temperature (−5 to 35 °C), normal humidity (85 %RH max.), shall not be exposed to direct sunlight and harmful gases and care should be taken so as not to cause dew.
- Operating Temperature : −40 to +85 °C

■ Storage Period

- Solderability may be reduced due to the conditions of high temperature and high humidity which causes the oxidation of tin-plated terminals. Even if storage conditions are within specified limits, solderability may be reduced with the passage of time. Therefore, please control the storage conditions and try to use the product within 6 months of receipt.

■ Packaging Methods, Soldering Conditions and Safety Precautions

Please see Data Files.

RF Type 1005 (0402)

● Dimensions in mm (not to scale)

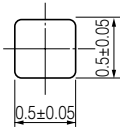
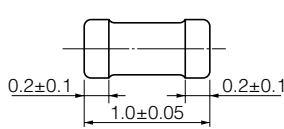

● Recommended Land Pattern in mm (not to scale)

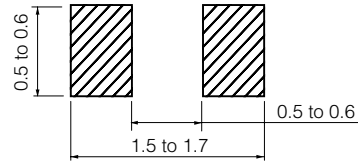

Standard Packing Quantity

● 10000 pcs./Reel

Standard Parts (E12 series)

Part No.	Inductance			Q		SRF *1 (MHz) min.	R _{DC} *2 (Ω) max.	DC Current (mA) max.
	(nH)	Tolerance (%)	Test Freq. (MHz)	min.	Test Freq. (MHz)			
ELJRF1N0□FB	1.0	D : ±0.3 nH Z : ±0.2 nH	100	8	100	6000	0.05	400
ELJRF1N2□FB	1.2					6000	0.06	400
ELJRF1N5□FB	1.5					6000	0.07	400
ELJRF1N8□FB	1.8					6000	0.08	400
ELJRF2N2□FB	2.2					6000	0.09	400
ELJRF2N7□FB	2.7					5500	0.10	400
ELJRF3N3□FB	3.3					5500	0.12	400
ELJRF3N9□FB	3.9					5200	0.15	360
ELJRF4N7□FB	4.7					4800	0.17	360
ELJRF5N6□FB	5.6					4600	0.19	340
ELJRF6N8□FB	6.8	J : ±5 % G : ±2 %	100	8	100	4000	0.30	320
ELJRF8N2□FB	8.2					3500	0.35	320
ELJRF10N□FB	10					2800	0.41	320
ELJRF12N□FB	12					2800	0.45	320
ELJRF15N□FB	15					2500	0.60	240
ELJRF18N□FB	18					2200	0.70	240
ELJRF22N□FB	22					2000	0.80	200
ELJRF27N□FB	27					1800	1.20	200
ELJRF33N□FB	33					1800	1.40	170
ELJRF39N□FB	39					1800	1.70	150
ELJRF47N□FB	47	1800	2.10	140				
ELJRF56N□FB	56	1500	2.50	130				
ELJRF68N□FB	68	1500	4.00	120				
ELJRF82N□FB	82	1400	4.50	110				
ELJRF100□FB	100	1200	5.50	90				

□ : Symbol of Tolerance *1 : Self Resonant Frequency *2 : DC Resistance

Standard Parts (E24 series)

Part No.	Inductance			Q		SRF *1 (MHz) min.	R _{DC} *2 (Ω) max.	DC Current (mA) max.
	(nH)	Tolerance (%)	Test Freq. (MHz)	min.	Test Freq. (MHz)			
ELJRF2N0□FB	2.0	D : ±0.3 nH Z : ±0.2 nH	100	8	100	6000	0.08	400
ELJRF2N4□FB	2.4					6000	0.09	400
ELJRF3N0□FB	3.0					5500	0.11	400
ELJRF3N6□FB	3.6					5300	0.14	380
ELJRF4N3□FB	4.3					5000	0.16	360
ELJRF5N1□FB	5.1					4700	0.18	350
ELJRF6N2□FB	6.2	J : ±5 % G : ±2 %	100	8	100	4300	0.25	330
ELJRF7N5□FB	7.5					3700	0.33	320
ELJRF9N1□FB	9.1					3100	0.38	320
ELJRF11N□FB	11					2800	0.43	320
ELJRF13N□FB	13					2600	0.53	280
ELJRF16N□FB	16					2300	0.65	240
ELJRF20N□FB	20					2100	0.75	220
ELJRF24N□FB	24					1900	1.00	200
ELJRF30N□FB	30					1800	1.30	190
ELJRF36N□FB	36					1800	1.60	160
ELJRF43N□FB	43	1800	1.90	150				

□ : Symbol of Tolerance *1 : Self Resonant Frequency *2 : DC Resistance

Design and specifications are each subject to change without notice. Ask factory for the current technical specifications before purchase and/or use.
Should a safety concern arise regarding this product, please be sure to contact us immediately.

■ ELJRF Type

■ Typical Characteristics

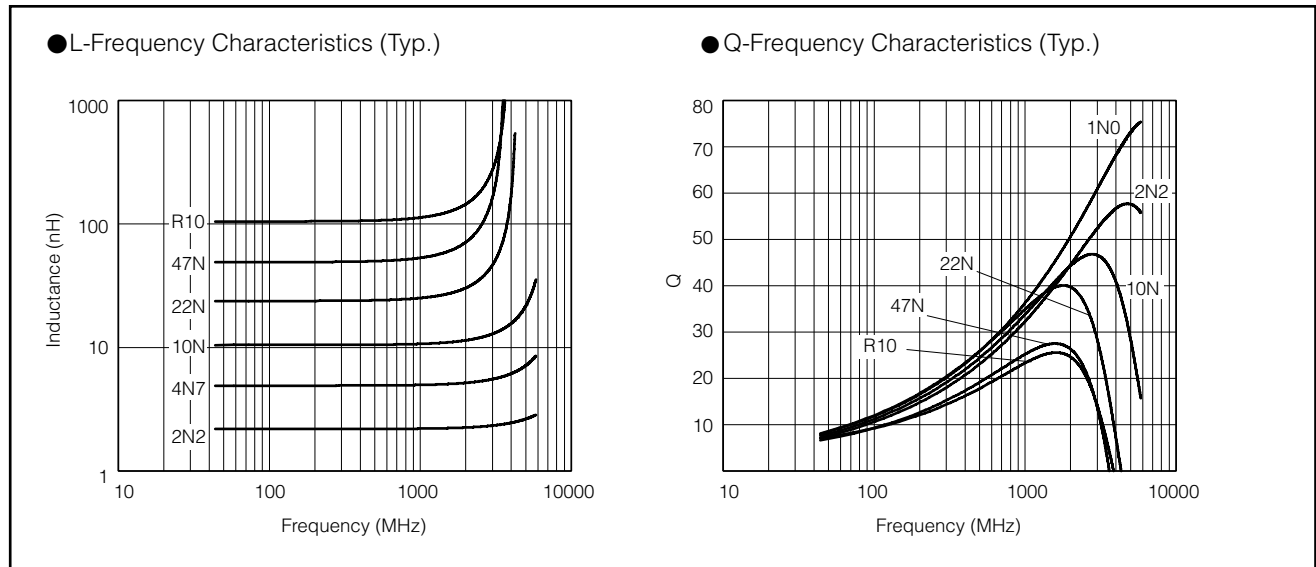

■ Reference Date

Part No	Inductance (nH)(Typ.)					Q(Typ.)				
	800MHz	900MHz	1.8GHz	2.0GHz	2.4GHz	800MHz	900MHz	1.8GHz	2.0GHz	2.4GHz
ELJRF1N0□FB	0.95	0.95	0.96	0.96	0.97	31.8	33.8	47.2	49.6	54.0
ELJRF1N2□FB	1.23	1.24	1.24	1.25	1.25	31.0	33.0	43.4	45.6	49.7
ELJRF1N5□FB	1.51	1.51	1.53	1.53	1.54	32.9	34.9	48.6	50.9	55.4
ELJRF1N8□FB	1.85	1.85	1.87	1.88	1.90	31.1	33.1	45.9	48.1	52.1
ELJRF2N2□FB	2.11	2.12	2.15	2.16	2.19	28.3	30.1	41.6	43.6	47.2
ELJRF2N7□FB	2.63	2.63	2.68	2.70	2.73	28.0	28.7	39.6	41.4	44.7
ELJRF3N3□FB	3.27	3.28	3.35	3.37	3.42	29.9	31.7	43.7	45.7	49.2
ELJRF3N9□FB	3.73	3.74	3.82	3.85	3.91	29.7	31.5	43.4	45.4	48.8
ELJRF4N7□FB	4.77	4.78	4.92	4.96	5.07	33.9	35.9	49.0	51.1	54.6
ELJRF5N6□FB	5.70	5.70	5.80	5.90	6.20	30.0	31.0	40.0	41.0	42.8
ELJRF6N8□FB	6.91	6.93	7.21	7.29	7.51	28.9	30.7	41.3	42.7	45.0
ELJRF8N2□FB	8.31	8.33	8.73	8.86	9.19	31.0	32.9	43.9	45.3	47.4
ELJRF10N□FB	10.21	10.25	10.77	10.94	11.37	29.8	31.6	42.1	43.5	45.6
ELJRF12N□FB	12.3	12.3	13.1	13.3	14.0	30.8	32.6	42.9	44.1	45.4
ELJRF15N□FB	15.3	15.4	16.5	16.9	17.9	28.8	30.4	39.5	40.4	41.2
ELJRF18N□FB	18.4	18.6	20.2	20.8	22.3	31.1	32.8	41.6	42.1	41.7
ELJRF22N□FB	23.7	23.9	27.5	28.8	32.5	31.3	32.9	39.6	39.4	37.2
ELJRF27N□FB	28.3	28.5	32.8	34.4	38.8	28.4	29.9	36.0	35.8	33.7
ELJRF33N□FB	34.6	35.1	43.4	46.8	57.5	28.4	29.7	33.7	32.9	29.2
ELJRF39N□FB	40.8	41.4	49.9	53.2	63.3	25.6	26.9	31.1	30.5	27.5
ELJRF47N□FB	49.6	50.3	62.1	66.8	81.8	22.7	23.8	26.9	26.2	23.2
ELJRF56N□FB	58.4	59.1	69.9	74.1	86.2	23.8	25.0	28.9	28.3	25.6
ELJRF68N□FB	71.9	72.9	90.4	97.5	119.9	22.3	23.3	25.4	24.3	20.4
ELJRF82N□FB	86.6	87.8	107.8	115.7	140.6	21.9	22.9	25.5	24.6	21.3
ELJRF10□FB	105.5	106.8	128.2	136.5	161.3	21.0	21.9	25.0	24.4	21.9

□ : Symbol of Tolerance

■ RE Type 1608 (0603)

● Dimensions in mm (not to scale)

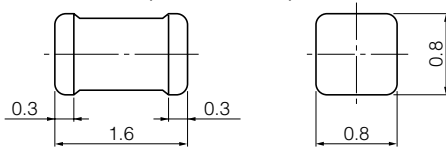

● Recommended Land Pattern in mm (not to scale)

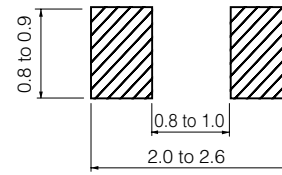

■ Standard Packing Quantity

● 3000 pcs./Reel

■ Standard Parts (E12 series)

Part No.	Inductance			Q		SRF *1 (MHz) min.	R _{DC} *2 (Ω) max.	DC Current (mA) max.
	(nH)	Tolerance (%)	Test Freq. (MHz)	min.	Test Freq. (MHz)			
ELJRE1N0□FA	1.0	D : ±0.3 nH	Z : ±0.2 nH	100	100	6000	0.05	500
ELJRE1N2□FA	1.2							
ELJRE1N5□FA	1.5							
ELJRE1N8□FA	1.8							
ELJRE2N2□FA	2.2							
ELJRE2N7□FA	2.7							
ELJRE3N3□FA	3.3							
ELJRE3N9□FA	3.9	J : ±5 %	G : ±2 %	100	100	5500	0.15	450
ELJRE4N7□FA	4.7							
ELJRE5N6□FA	5.6							
ELJRE6N8□FA	6.8							
ELJRE8N2□FA	8.2							
ELJRE10N□FA	10							
ELJRE12N□FA	12							
ELJRE15N□FA	15							
ELJRE18N□FA	18							
ELJRE22N□FA	22							
ELJRE27N□FA	27							
ELJRE33N□FA	33							
ELJRE39N□FA	39							
ELJRE47N□FA	47							
ELJRE56N□FA	56							
ELJRE68N□FA	68							
ELJRE82N□FA	82							
ELJRER10□FA	100	4	25.2	25.2	1300	1.80	200	
ELJRER12□FA	120							
ELJRER15□FA	150							
ELJRER18□FA	180							
ELJRER22□FA	220				900	7.50	70	

□ : Symbol of Tolerance *1 : Self Resonant Frequency *2 : DC Resistance

■ ELJRE Type

■ Typical Characteristics

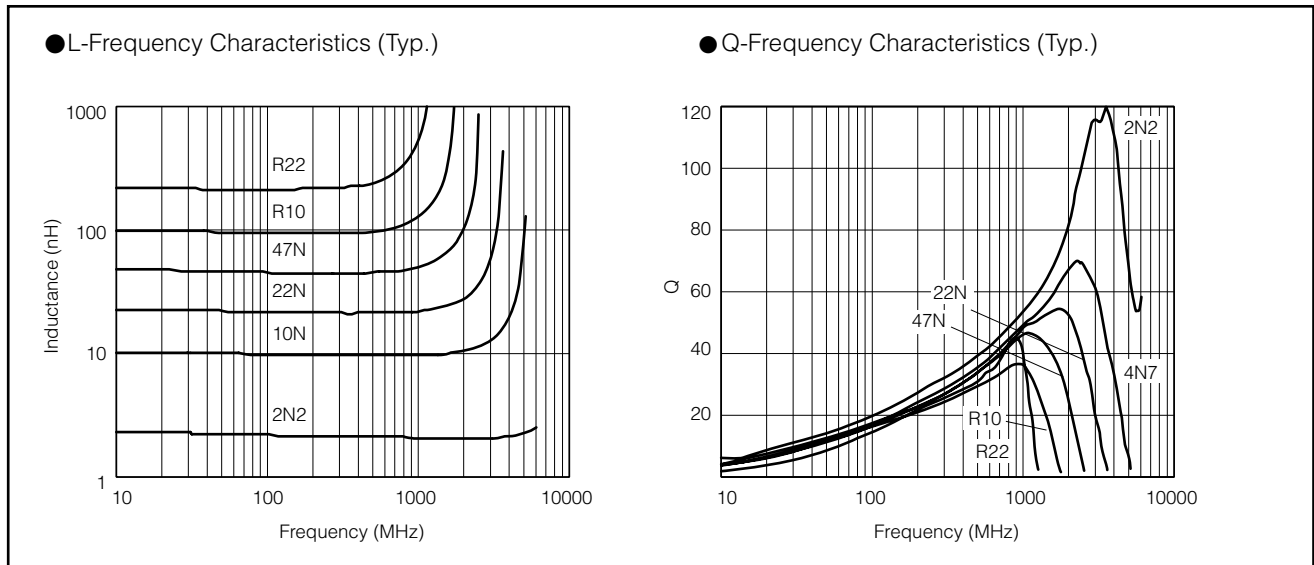

■ Reference Date

Part No	Inductance (nH)(Typ.)					Q(Typ.)				
	800MHz	900MHz	1.8GHz	2.0GHz	2.4GHz	800MHz	900MHz	1.8GHz	2.0GHz	2.4GHz
ELJRE1N0□FA	1.01	1.01	0.99	0.98	0.98	71.2	76.8	116.8	129.6	155.8
ELJRE1N2□FA	1.19	1.19	1.18	1.17	1.17	65.1	69.8	102.7	113.9	136.9
ELJRE1N5□FA	1.41	1.41	1.39	1.39	1.38	52.7	56.2	79.6	88.0	103.3
ELJRE1N8□FA	1.86	1.86	1.84	1.84	1.84	55.9	59.6	86.7	97.5	117.0
ELJRE2N2□FA	2.10	2.09	2.07	2.07	2.07	48.6	51.3	74.8	83.6	98.6
ELJRE2N7□FA	2.59	2.59	2.58	2.59	2.60	48.6	51.3	71.1	78.1	89.9
ELJRE3N3□FA	3.09	3.08	3.08	3.09	3.11	49.6	52.7	78.5	88.6	105.8
ELJRE3N9□FA	3.61	3.61	3.63	3.65	3.69	50.2	53.0	70.5	77.1	87.0
ELJRE4N7□FA	4.42	4.42	4.48	4.52	4.60	46.3	49.4	69.4	76.6	86.1
ELJRE5N6□FA	5.39	5.39	5.49	5.55	5.66	49.5	52.8	75.4	84.0	94.3
ELJRE6N8□FA	6.59	6.60	6.79	6.89	7.08	49.3	52.8	78.1	86.7	97.0
ELJRE8N2□FA	7.97	7.99	8.33	8.51	8.83	49.0	52.4	75.4	82.6	89.1
ELJRE10N□FA	9.60	9.63	10.22	10.51	11.07	44.2	47.0	63.4	68.0	69.7
ELJRE12N□FA	11.7	11.8	12.7	13.2	14.1	44.6	47.7	64.7	68.5	67.8
ELJRE15N□FA	14.6	14.6	16.2	17.1	18.7	42.4	45.4	58.4	59.5	56.9
ELJRE18N□FA	17.6	17.8	20.2	21.5	24.2	45.9	49.4	64.6	65.0	58.8
ELJRE22N□FA	21.7	21.9	26.0	28.3	33.3	43.0	45.8	54.2	52.2	43.8
ELJRE27N□FA	27.2	27.6	34.6	38.9	49.3	43.9	47.0	52.4	49.2	38.1
ELJRE33N□FA	33.3	33.9	45.5	53.2	75.2	41.8	44.4	45.2	39.3	26.2
ELJRE39N□FA	39.8	40.7	58.6	71.9	117.0	42.2	44.9	40.4	33.1	18.8
ELJRE47N□FA	48.3	49.6	79.8	107.1	260.7	42.6	45.3	34.1	24.0	8.8
ELJRE56N□FA	59.2	61.1	112.8	176.3	735.5	42.0	44.5	25.1	15.2	0.8
ELJRE68N□FA	73.9	77.0	185.9	459.7		41.8	44.0	21.5	9.5	
ELJRE82N□FA	94.0	99.6	494.3			39.7	41.5	7.7		
ELJRER10□FA	115.2	123.5	2141.2			35.3	36.7	1.6		
ELJRER12□FA	143.4	156.9				35.2	35.7			
ELJRER15□FA	188.5	210.6				40.6	41.5			
ELJRER18□FA	242.9	280.4				39.0	39.8			
ELJRER22□FA	337.9	416.6				43.2	45.3			

□ : Symbol of Tolerance

Design and specifications are each subject to change without notice. Ask factory for the current technical specifications before purchase and/or use. Should a safety concern arise regarding this product, please be sure to contact us immediately.

Chip Inductors High Frequency Use High-Q (Non Magnetic Core)

Type: **ELJQF**
ELJQE



■ Features

- High frequency capability due to its non magnetic core.
- Capable of being Re-flow or flow soldered.
- Unique Ceramic Core / Laser-cut Technology.
- Non polarity product.
- High self resonance frequency.
- Good for mounting.
- RoHS compliant

■ Recommended Applications

- RF circuitry for cellular phones and wireless communication equipment.

■ Explanation of Part Numbers

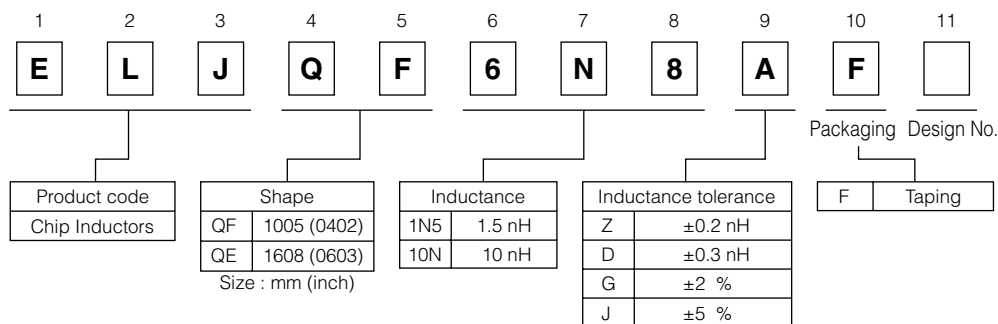

■ Storage Conditions

- Package : Normal temperature (−5 to 35 °C), normal humidity (85 %RH max.), shall not be exposed to direct sunlight and harmful gases and care should be taken so as not to cause dew.
- Operating Temperature : −40 to +85 °C

■ Storage Period

- Solderability may be reduced due to the conditions of high temperature and high humidity which causes the oxidation of tin-plated terminals. Even if storage conditions are within specified limits, solderability may be reduced with the passage of time. Therefore, please control the storage conditions and try to use the product within 6 months of receipt.

■ Packaging Methods, Soldering Conditions and Safety Precautions

Please see Data Files.

■ QF Type 1005 (0402)

● Dimensions in mm (not to scale)

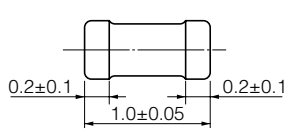

● Recommended Land Pattern in mm (not to scale)

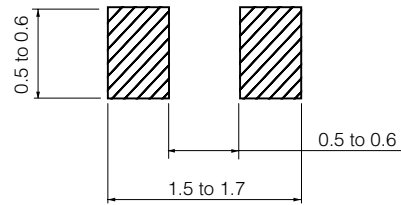

■ Standard Packing Quantity

● 10000 pcs./Reel

■ Standard Parts (E12 series)

Part No.	Inductance			Q		SRF *1 (MHz) min.	R _{DC} *2 (Ω) max.	DC Current (mA) max.
	(nH)	Tolerance (%)	Test Freq. (MHz)	100 MHz min.	800 MHz typ.			
ELJQF1N0□F	1.0	D : ±0.3 nH Z : ±0.2 nH	100	10	41	6000	0.05	400
ELJQF1N2□F	1.2				41	6000	0.06	400
ELJQF1N5□F	1.5				40	6000	0.07	400
ELJQF1N8□F	1.8				40	6000	0.08	400
ELJQF2N2□F	2.2				40	6000	0.09	400
ELJQF2N7□F	2.7				40	5500	0.10	400
ELJQF3N3□F	3.3				39	5500	0.12	400
ELJQF3N9□F	3.9				39	5200	0.15	360
ELJQF4N7□F	4.7				39	4800	0.17	360
ELJQF5N6□F	5.6				J : ±5 % G : ±2 %	100	10	39
ELJQF6N8□F	6.8	39	4000	0.30				320
ELJQF8N2□F	8.2	39	3500	0.35				320
ELJQF10N□F	10	39	2800	0.41				320
ELJQF12N□F	12	38	2800	0.45				320
ELJQF15N□F	15	36	2500	0.60				240
ELJQF18N□F	18	36	2200	0.70				240
ELJQF22N□F	22	36	2000	0.80				200
ELJQF27N□F	27	36	1800	1.20				200
ELJQF33N□F	33	35	1800	1.40				170
ELJQF39N□F	39	35	1800	1.70	150			

□ : Symbol of Tolerance *1 : Self Resonant Frequency *2 : DC Resistance

■ Standard Parts (E24 series)

Part No.	Inductance			Q		SRF *1 (MHz) min.	R _{DC} *2 (Ω) max.	DC Current (mA) max.
	(nH)	Tolerance (%)	Test Freq. (MHz)	100 MHz min.	800 MHz typ.			
ELJQF1N1□F	1.1	D : ±0.3 nH Z : ±0.2 nH	100	10	41	6000	0.06	400
ELJQF1N3□F	1.3				40	6000	0.07	400
ELJQF1N6□F	1.6				40	6000	0.08	400
ELJQF2N0□F	2.0				40	6000	0.09	400
ELJQF2N4□F	2.4				40	5500	0.10	400
ELJQF3N0□F	3.0				39	5500	0.12	400
ELJQF3N6□F	3.6				39	5300	0.14	380
ELJQF4N3□F	4.3				39	5000	0.16	360
ELJQF5N1□F	5.1				39	4700	0.18	350
ELJQF6N2□F	6.2				39	4300	0.25	330
ELJQF7N5□F	7.5	J : ±5 % G : ±2 %	100	10	39	3700	0.33	320
ELJQF9N1□F	9.1				39	3100	0.38	320
ELJQF11N□F	11				38	2800	0.43	320
ELJQF13N□F	13				36	2600	0.53	280
ELJQF16N□F	16				36	2300	0.65	240
ELJQF20N□F	20				36	2100	0.75	220
ELJQF24N□F	24				36	1900	1.00	200
ELJQF30N□F	30				35	1800	1.30	190
ELJQF36N□F	36				35	1800	1.60	160

□ : Symbol of Tolerance *1 : Self Resonant Frequency *2 : DC Resistance

Design and specifications are each subject to change without notice. Ask factory for the current technical specifications before purchase and/or use.
Should a safety concern arise regarding this product, please be sure to contact us immediately.

■ ELJQF Type

■ Typical Characteristics

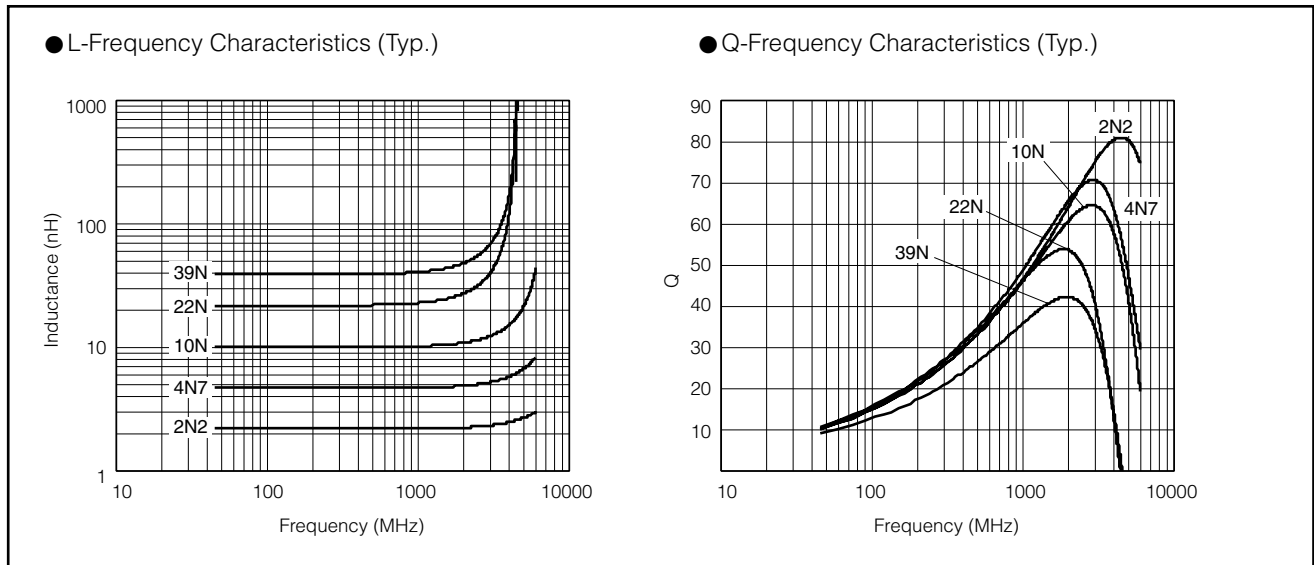

■ Reference Data

Part No.	Inductance (nH)(Typ.)					Q(Typ.)				
	800MHz	900MHz	1.8GHz	2.0GHz	2.4GHz	800MHz	900MHz	1.8GHz	2.0GHz	2.4GHz
ELJQF1N0□F	1.00	1.00	1.01	1.01	1.02	42.8	46.1	64.1	67.7	73.6
ELJQF1N2□F	1.20	1.21	1.22	1.22	1.23	44.4	47.1	65.8	69.0	75.1
ELJQF1N5□F	1.51	1.51	1.53	1.53	1.55	43.7	46.4	64.5	67.6	73.3
ELJQF1N8□F	1.78	1.78	1.81	1.82	1.84	40.0	42.4	58.8	61.5	66.6
ELJQF2N2□F	2.19	2.19	2.24	2.25	2.28	41.9	44.5	61.4	64.2	69.3
ELJQF2N7□F	2.73	2.73	2.79	2.81	2.85	46.3	49.1	67.7	70.7	76.2
ELJQF3N3□F	3.32	3.33	3.40	3.43	3.48	47.2	50.0	68.8	71.8	77.1
ELJQF3N9□F	3.98	3.99	4.11	4.15	4.24	43.0	45.6	62.0	64.4	68.4
ELJQF4N7□F	4.70	4.71	4.86	4.91	5.02	44.1	46.8	63.2	65.6	69.1
ELJQF5N6□F	5.59	5.60	5.80	5.87	6.02	44.2	46.9	63.6	66.1	70.3
ELJQF6N8□F	6.82	6.84	7.13	7.22	7.46	42.6	45.1	60.4	62.5	65.4
ELJQF8N2□F	8.33	8.35	8.76	8.89	9.22	41.3	43.7	58.2	60.0	62.3
ELJQF10N□F	10.14	10.18	10.76	10.94	11.42	41.8	44.2	58.8	60.8	63.5
ELJQF12N□F	12.0	12.1	12.9	13.2	13.9	44.1	46.7	59.9	61.0	60.9
ELJQF15N□F	15.2	15.3	16.7	17.2	18.4	42.3	44.6	56.2	56.8	55.7
ELJQF18N□F	18.3	18.4	20.2	20.8	22.5	43.4	45.7	55.8	55.5	52.1
ELJQF22N□F	22.5	22.8	26.2	27.4	30.9	42.4	44.6	53.8	53.7	50.8
ELJQF27N□F	27.8	28.1	33.3	35.3	41.2	39.6	41.6	48.8	48.1	44.1
ELJQF33N□F	33.7	34.0	38.4	40.0	44.3	35.6	37.4	45.4	45.3	42.9
ELJQF39N□F	40.1	40.5	46.2	48.2	53.9	32.8	34.5	42.2	42.3	40.9

□ : Symbol of Tolerance

■ QE Type 1608 (0603)

● Dimensions in mm (not to scale)

● Recommended Land Pattern in mm (not to scale)

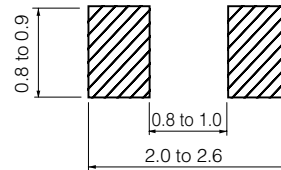
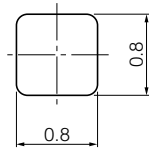
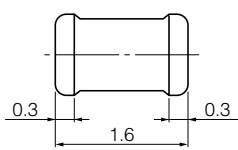

■ Standard Packing Quantity

● 3000 pcs./Reel

■ Standard Parts (E12 series)

Part No.	Inductance			Q		SRF *1 (MHz) min.	R _{DC} *2 (Ω) max.	DC Current (mA) max.		
	(nH)	Tolerance (%)	Test Freq. (MHz)	100 MHz min.	800 MHz typ.					
ELJQE2N2□FA	2.2	D : ±0.3 nH Z : ±0.2 nH	100	15	88.6	6000	0.04	970		
ELJQE2N7□FA	2.7				65.4	6000	0.05	880		
ELJQE3N3□FA	3.3				61.3	6000	0.06	800		
ELJQE3N9□FA	3.9				68.4	6000	0.07	750		
ELJQE4N7□FA	4.7				65.2	6000	0.09	660		
ELJQE5N6□FA	5.6				57.4	6000	0.11	600		
ELJQE6N8□FA	6.8	J : ±5 % G : ±2 %			100	15	65.0	6000	0.14	540
ELJQE8N2□FA	8.2						65.5	5700	0.17	490
ELJQE10N□FA	10						63.8	5300	0.21	450
ELJQE12N□FA	12						61.9	4900	0.26	400
ELJQE15N□FA	15						59.0	4400	0.34	350
ELJQE18N□FA	18						58.6	4000	0.41	320
ELJQE22N□FA	22	59.1					3700	0.52	290	
ELJQE27N□FA	27	55.0					3400	0.66	260	
ELJQE33N□FA	33	54.2					3000	0.82	230	
ELJQE39N□FA	39	52.9					2800	1.00	210	
ELJQE47N□FA	47	54.4					2500	1.23	190	
ELJQE56N□FA	56	51.5					2500	1.51	180	

□ : Symbol of Tolerance *1 : Self Resonant Frequency *2 : DC Resistance

■ ELJQE Type

■ Typical Characteristics

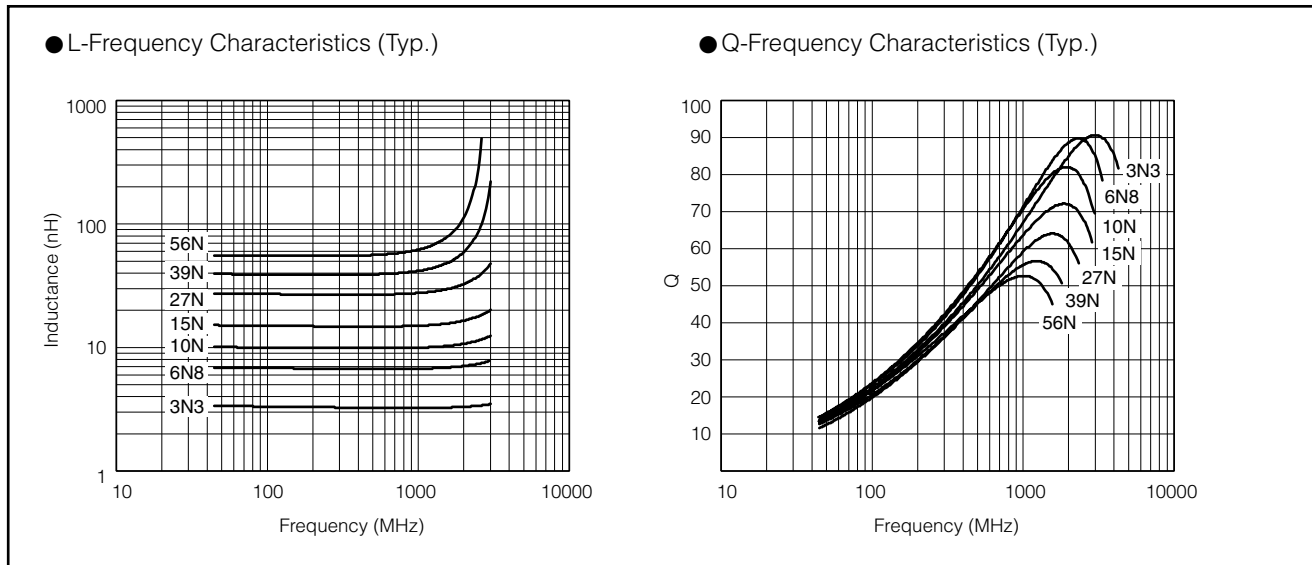

■ Reference Data

Part No.	Inductance (nH)(Typ.)					Q(Typ.)				
	800MHz	900MHz	1.8GHz	2.0GHz	2.4GHz	800MHz	900MHz	1.8GHz	2.0GHz	2.4GHz
ELJQE2N2□FA	2.18	2.18	2.23	2.25	2.30	88.6	92.5	117.0	119.5	122.5
ELJQE2N7□FA	2.62	2.62	2.69	2.71	2.78	65.4	68.4	87.2	89.3	92.4
ELJQE3N3□FA	3.24	3.24	3.29	3.30	3.36	61.3	64.2	82.6	84.9	88.7
ELJQE3N9□FA	3.83	3.83	3.91	3.93	4.01	68.4	71.9	94.8	97.6	102.1
ELJQE4N7□FA	4.61	4.61	4.74	4.78	4.91	65.2	68.4	88.3	90.4	93.0
ELJQE5N6□FA	5.48	5.48	5.62	5.67	5.82	57.4	60.1	77.2	79.2	82.0
ELJQE6N8□FA	6.70	6.71	6.96	7.05	7.30	65.0	68.2	87.0	88.6	89.7
ELJQE8N2□FA	8.12	8.14	8.57	8.71	9.12	65.5	68.4	84.0	84.7	83.5
ELJQE10N□FA	9.89	9.92	10.5	10.7	11.3	63.8	66.7	81.5	82.1	80.5
ELJQE12N□FA	12.0	12.0	12.9	13.1	14.0	61.9	64.6	77.8	78.0	75.4
ELJQE15N□FA	14.9	14.9	16.1	16.4	17.6	59.0	61.4	72.1	72.0	69.0
ELJQE18N□FA	18.0	18.1	20.1	20.8	22.9	58.6	61.0	70.1	69.2	64.0
ELJQE22N□FA	22.0	22.1	24.9	25.9	29.0	59.1	61.3	67.8	66.1	59.0
ELJQE27N□FA	27.1	27.3	31.2	32.5	36.7	55.0	57.2	63.3	61.6	54.3
ELJQE33N□FA	33.9	34.4	43.7	47.4	61.4	54.2	55.9	54.7	51.0	39.1
ELJQE39N□FA	40.3	40.9	53.6	58.9	79.9	52.9	54.4	50.6	46.3	33.2
ELJQE47N□FA	49.6	50.5	72.7	83.1	134.8	54.4	55.4	44.2	38.1	21.6
ELJQE56N□FA	58.8	60.1	93.6	111.2	223.8	51.5	52.3	37.7	30.9	13.6

□ : Symbol of Tolerance

Chip Inductors High Power Type

Type: **ELJPF**
ELJPE



■ Features

- Low DCR and large current capability, suitable for power circuitry.
- High frequency capability due to its non magnetic core.
- Capable of being Re-flow or flow soldered.
- Unique Ceramic Core / Laser-cut Technology.
- Non polarity product.
- Good for mounting.
- RoHS compliant

■ Recommended Applications

- Wireless communication equipment and various types of general electronic equipment.

■ Explanation of Part Numbers

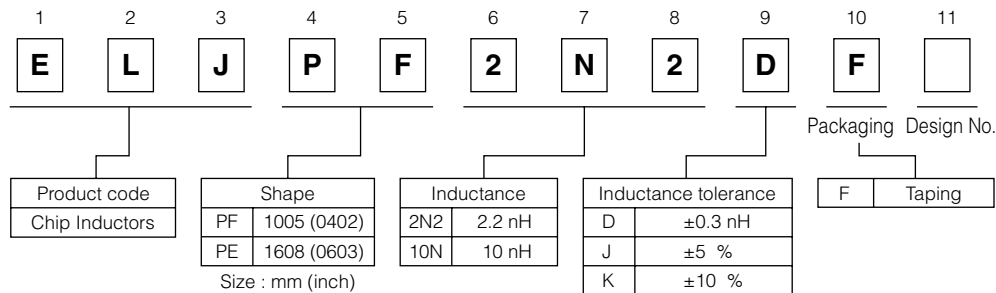

■ Storage Conditions

- Package : Normal temperature (−5 to 35 °C), normal humidity (85 %RH max.), shall not be exposed to direct sunlight and harmful gases and care should be taken so as not to cause dew.
- Operating Temperature : −40 to +85 °C

■ Storage Period

- Solderability may be reduced due to the conditions of high temperature and high humidity which causes the oxidation of tin-plated terminals. Even if storage conditions are within specified limits, solderability may be reduced with the passage of time. Therefore, please control the storage conditions and try to use the product within 6 months of receipt.

■ Packaging Methods, Soldering Conditions and Safety Precautions

Please see Data Files.

■ PF Type 1005 (0402)

● Dimensions in mm (not to scale)

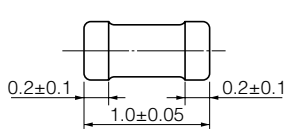

● Recommended Land Pattern in mm (not to scale)

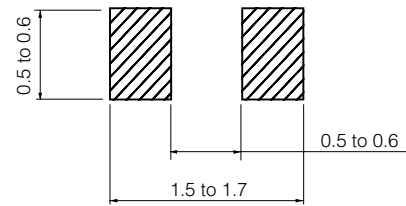

■ Standard Packing Quantity

● 10000 pcs./Reel

■ Standard Parts

Part No.	Inductance			Q		SRF *1 (MHz) min.	R _{DC} *2 (Ω) max.	DC Current (mA) max.
	(nH)	Tolerance (%)	Test Freq. (MHz)	min.	Test Freq. (MHz)			
ELJPF2N2DFB	2.2	D : ±0.3 nH	100	7	100	5300	0.040	1900
ELJPF2N7DFB	2.7					5300	0.050	1800
ELJPF3N3DFB	3.3					5000	0.070	1500
ELJPF3N9DFB	3.9					4800	0.080	1400
ELJPF4N7DFB	4.7					4600	0.100	1300
ELJPF5N6DFB	5.6					4200	0.120	1200
ELJPF6N8JFB	6.8	J : ± 5 %	100	7	100	4000	0.160	1100
ELJPF8N2JFB	8.2					3700	0.210	900
ELJPF10NJFB	10					3200	0.260	750

*1 : Self Resonant Frequency *2 : DC Resistance

■ PE Type 1608 (0603)

● Dimensions in mm (not to scale)

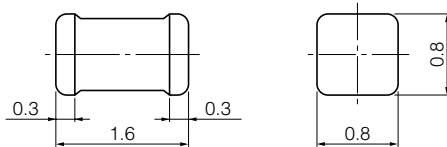

● Recommended Land Pattern in mm (not to scale)

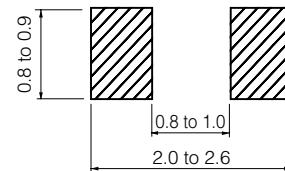

■ Standard Packing Quantity

● 3000 pcs./Reel

■ Standard Parts (E12 Series)

Part No.	Inductance			Q		SRF *1 (MHz) min.	R _{DC} *2 (Ω) max.	DC Current (mA) max.
	(nH)	Tolerance (%)	Test Freq. (MHz)	min.	Test Freq. (MHz)			
ELJPE2N2KFA	2.2	K : ± 10 %	100	8	100	6000	0.030	2100
ELJPE2N7KFA	2.7			8		5500	0.030	2100
ELJPE3N3KFA	3.3			8		5500	0.040	2100
ELJPE3N9KFA	3.9			9		5200	0.040	2100
ELJPE4N7KFA	4.7			9		4800	0.050	2100
ELJPE5N6KFA	5.6			9		4600	0.055	2100
ELJPE6N8KFA	6.8			9		4000	0.055	1900
ELJPE8N2KFA	8.2			9		3500	0.060	1700
ELJPE10NKFA	10			9		2800	0.065	1400
ELJPE12NKFA	12			9		2500	0.080	1300
ELJPE15NKFA	15			9		2200	0.100	900
ELJPE18NKFA	18			9		2000	0.120	800
ELJPE22NKFA	22			9		1800	0.150	700

*1 : Self Resonant Frequency *2 : DC Resistance

Design and specifications are each subject to change without notice. Ask factory for the current technical specifications before purchase and/or use. Should a safety concern arise regarding this product, please be sure to contact us immediately.

■ Packaging Methods (Taping)

● Punched Carrier Tape Dimensions in mm (not to scale)

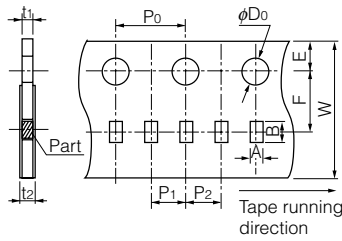

● Type □F

	A	B	W	E	F	P ₁
RF, QF, PF	0.71	1.21	8.0	1.75	3.5	2.0
	P ₂	P ₀	φD ₀	t ₁	t ₂	
RF, QF, PF	2.0	4.0	φ1.5	0.7 max.	1.0 max.	

● Embossed Carrier Tape Dimensions in mm (not to scale)

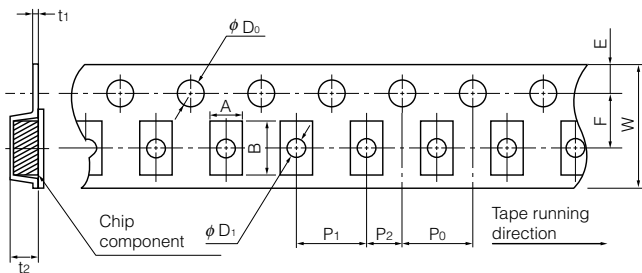

● Type □E

	A	B	W	E	F	P ₁
RE, QE, PE	1.0	1.8	8.0	1.75	3.5	4.0
	P ₂	P ₀	φD ₀	φD ₁	t ₁	t ₂
RE, QE, PE	2.0	4.0	φ1.5	φ0.6	(0.27)	1.2

● Taping Reel Dimensions in mm (not to scale)

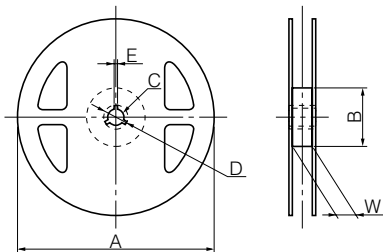

Types	Parts					
	A	B	C	D	E	W
RF, QF, PF RE, QE, PE	180	60	13	21	2	9

■ Standard Packing Quantity/Reel

Types	Quantity	Quantity
RF, QF, PF		10000 pcs.
RE, QE, PE		3000 pcs.

* Under conditions of high temperature and humidity deterioration of the taping and packaging may be accelerated.

Please carefully control storage conditions and use the product within 6 months of receipt.

Soldering Conditions

■ Reflow soldering conditions

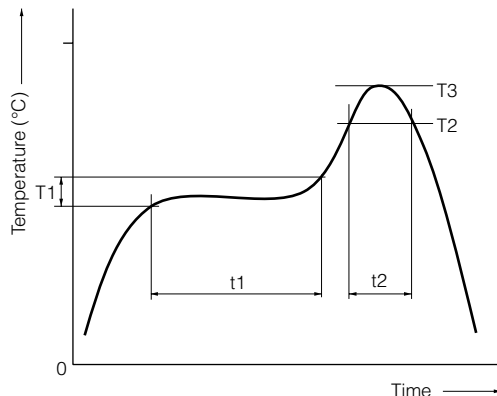

● Pb free solder recommended temperature profile

Type	Preheat		Soldering		Peak Temperature		Time of Reflow
	T1 [°C]	t1 [s]	T2 [°C]	t2 [s]	T3	T3 Limit	
□F	150 to 180	60 to 120	230 °C	40 max.	250 °C, 10 s	260 °C, 10 s	2 times max.
□E	150 to 180	60 to 120	230 °C	40 max.	250 °C, 10 s	260 °C, 10 s	2 times max.

■ Flow soldering conditions

Preheat: 130 to 150 °C, 60 to 180 s, Soldering: 260 °C, 5 s max.

■ Notes

- Solderability may be reduced due to the conditions of high temperature and high humidity which causes the oxidation of tin-plated terminals. Even if storage conditions are within specified limits, solderability may be reduced with the passage of time. Therefore, please control the storage conditions and try to use the product within 6 months of receipt.
- In case the product has been stored for a period longer than 6 months, use the product only after confirmation of its solderability.

⚠ Safety Precautions (Common precautions for Chip Inductors)

- When using our products, no matter what sort of equipment they might be used for, be sure to make a written agreement on the specifications with us in advance. The design and specifications in this catalog are subject to change without prior notice.
- Do not use the products beyond the specifications described in this catalog.
- This catalog explains the quality and performance of the products as individual components. Before use, check and evaluate their operations when installed in your products.
- Install the following systems for a failsafe design to ensure safety if these products are to be used in equipment where a defect in these products may cause the loss of human life or other significant damage, such as damage to vehicles (automobile, train, vessel), traffic lights, medical equipment, aerospace equipment, electric heating appliances, combustion/gas equipment, rotating equipment, and disaster/crime prevention equipment.
- * Systems equipped with a protection circuit and a protection device
- * Systems equipped with a redundant circuit or other system to prevent an unsafe status in the event of a single fault

⚠ Precautions for use

1. Operation range and environments

- ① These products are designed and manufactured for general and standard use in general electronic equipment (e.g. AV equipment, home electric appliances, office equipment, information and communication equipment)
- ② These products are not intended for use in the following special conditions. Before using the products, carefully check the effects on their quality and performance, and determine whether or not they can be used.
 - In liquid, such as water, oil, chemicals, or organic solvent
 - In direct sunlight, outdoors, or in dust
 - In salty air or air with a high concentration of corrosive gas, such as Cl₂, H₂S, NH₃, SO₂, or NO₂
 - In an environment where these products cause dew condensation

2. Handling

- ① Do not bring magnets or magnetized materials close to the product. The influence of their magnetic field can change the inductance value.
- ② Do not apply strong mechanical shocks by either dropping or collision with other parts.
Excessive shock can damage the part.

3. Land pattern design

- ① Please refer to the recommended land pattern for each type shown on the datasheet.
- ② Avoid placing the chip inductor on any metal pattern except the recommended land pattern because a drop of Q and mutual conductance may occur.
- ③ In case of flow soldering, venting of soldering flux gases should be made for high density assemblies to get a good solder connection.
- ④ In case of reflow soldering, consider the layout because taller components close to chip inductor tend to block thermal conduction.

4. Mounting

- ① In general, magnetic and electric characteristics of ferrite cores can be changed by applying excessively strong force. Placement force should not exceed 20 N.
- ② Do not bend or twist the PWB after mounting the part.

5. Cleaning

- ① Do not use acid or alkali agents. Some cleaning solvents may damage the part.
Confirm by testing the reliability in advance of mass production.
- ② If Ultrasonic cleaning is used, please confirm the reliability in advance.
It is possible that combined resonance of component and PWB and cavitation can cause an abnormal vibration mode to exist causing damage.

6. Caution about applying excessive current

The rated current is defined as the smaller value of either the current value when the inductance drops 10 % down from the initial point or the current value when the average temperature of coil inside rises 20 °C up from the initial point. Do not operate product over the specific max. current.

<Package markings>

Package markings include the product number, quantity, and country of origin.
In principle, the country of origin should be indicated in English.

Voltage Step-up Coils

Series: **Chip**
Type: **3KN**



High inductance Voltage Step-up coil chip series for piezoelectric buzzers and DC-DC circuitry of EL panels

ELT3KN

■ Features

- Small and thin
- High inductance
- RoHS compliant

■ Recommended Applications

- Watches, Toys, Cameras, Electronic thermometers
- Pagers, PHS, wireless telephones

■ Explanation of Part Numbers

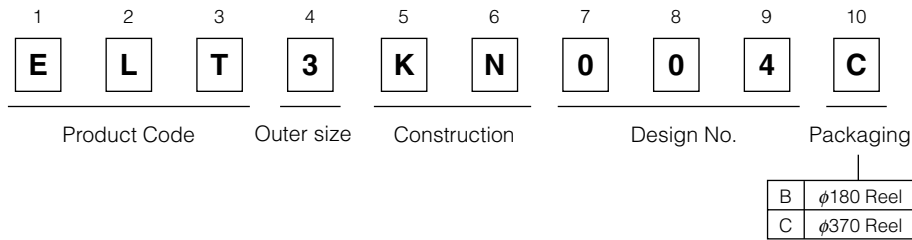

■ Standard Packing Quantity

- 1000 or 5000 pcs./Reel

■ Dimensions in mm (not to scale)

- Type 3KN

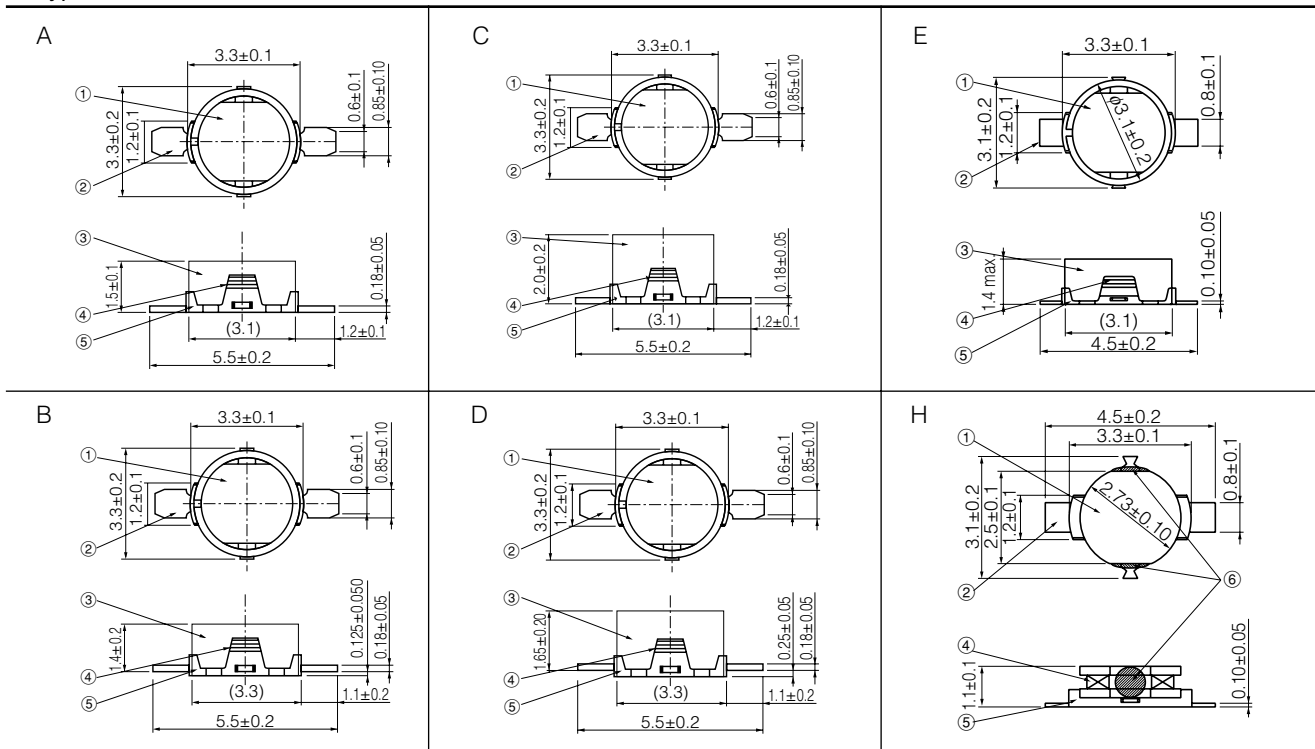

Part Name: ① Core ② Terminal ③ Ring ④ Coil ⑤ Terminal board ⑥ Adhesive

Design and specifications are each subject to change without notice. Ask factory for the current technical specifications before purchase and/or use. Should a safety concern arise regarding this product, please be sure to contact us immediately.

■ Standard Parts

Part No.	Inductance		R. D. C		I.D.C (mA) max.	Dimensions	Magnetic Composition		
	(mH)	Tolerance(%)	(Ω)	Tolerance(%)					
ELT3KN004□	14.00	±40	125	±10	1.7	A	Permalloy ring		
ELT3KN007□	20.00		170		1.4				
ELT3KN113□	1.00	±10	34	±15	25.0		Brass ring		
ELT3KN126□	1.50		49		29.0				
ELT3KN142□	0.82		24		30.0				
ELT3KN019□	14.00	±40	125	±10	1.7	B	Permalloy ring		
ELT3KN109□	3.80	±10	115	±20	15.0		Brass ring		
ELT3KN114□	2.50		83	±15	15.0				
ELT3KN014□	30.00	±40	150	±10	1.9	C	Brass ring		
ELT3KN018□	35.00		235		±15			1.9	
ELT3KN028□	50.00	±35	250	±15	1.4				
ELT3KN032□	25.00	±40	185		10.0				
ELT3KN101□	10.00	±10	285	±15	1.4				
ELT3KN104□	1.00		35		30.0				
ELT3KN118□	2.50		64		20.0				
ELT3KN121□	1.00		22.5		40.0				
ELT3KN122□	2.00		44		20.0				
ELT3KN123□	1.00		25		30.0				
ELT3KN124□	4.00		85		15.0				
ELT3KN127□	0.47		14		50.0				
ELT3KN128□	0.56		15		45.0				
ELT3KN129□	0.68		17		34.0				
ELT3KN130□	2.30		51		23.0				
ELT3KN131□	2.00		44		20.0				
ELT3KN020□	30.00		±30		150	±10	2.5	D	Permalloy ring
ELT3KN111□	7.50		±10		177		10.0	15.0	Brass ring
ELT3KN125□	4.00	85							
ELT3KN041□	14.00	±40	125	±10	1.7	E	Permalloy ring		
ELT3KN042□	20.00		175		1.4				
ELT3KN043□	12.00		117		1.7				
ELT3KN139□	0.68	±10	19	±15	40.0	Brass ring			
ELT3KN140□	0.82		22		30.0				
ELT3KN135□	1.10		32		30.0				
ELT3KN136□	2.00		55		20.0				
ELT3KN137□	4.00		117	±10	15.0				
ELT3KN149□	0.33		11	±15	60.0				
ELT3KN151□	0.56		17		50.0				
ELT3KN152□	0.47		14		50.0				
ELT3KN155□	1.10		38		25.0	H	Ring less		
ELT3KN162□	4.00		117	±10	15.0	E	Brass ring		
ELT3KN163□	1.10	32	±15	30.0					

“□” shows the packaging specifications.

■ Packaging Methods

● Standard Packing Quantity

Packaging	ELT3KN	Kind of Taping
B	1000 pcs.	Embossed Carrier Taping
C	5000 pcs.	

● Reel Dimensions in mm (not to scale)

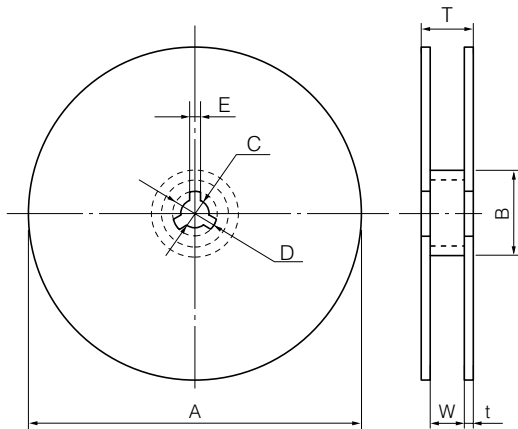

Packaging	A	B	C	D	E	W	t	T
B	180	60	13	21	2	13	1.1	15.2
C	370	60	13	21	2	14	2.0	18

● Embossed Carrier Tape Dimensions in mm (not to scale)

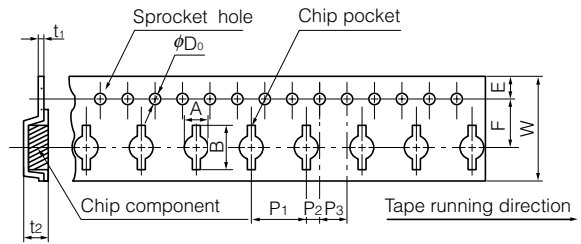

Type	A	B	W	F	E	P ₁
ELT3KN	3.7	6.4	12.0	5.5	1.75	8.0

Type	P ₂	P ₃	ϕD_0	t ₁	t ₂
ELT3KN	2.0	4.0	1.5	0.3	2.6

● Leader Part, Vacant Position

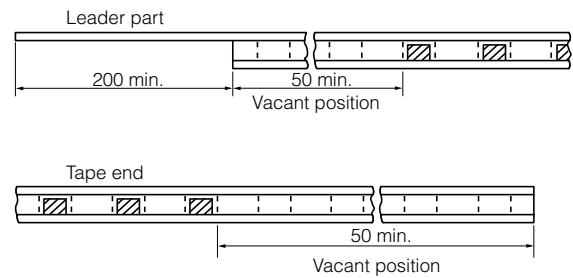

■ Applied Diagram Examples

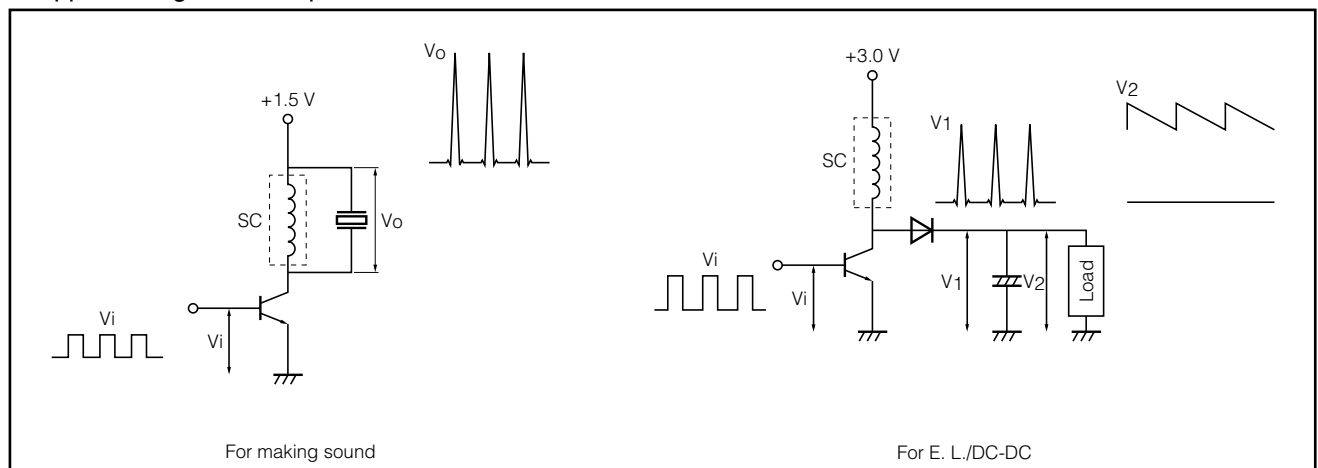

Soldering Conditions

■ Reflow soldering conditions

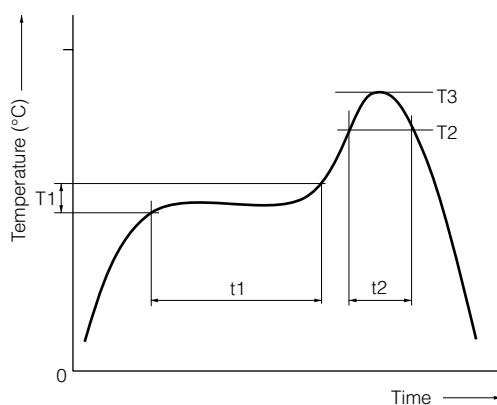

● Pb free solder recommended temperature profile

Type	Preheat		Soldering		Peak Temperature		Time of Reflow
	T1 [°C]	t1 [s]	T2 [°C]	t2 [s]	T3	T3 Limit	
ELT3KN	150 to 170	60 to 120	230 °C	30 max.	245 °C, 10 s	260 °C, 10 s	2 times max.

⚠ Safety Precautions (Common precautions for Voltage Step-up Coils)

- When using our products, no matter what sort of equipment they might be used for, be sure to make a written agreement on the specifications with us in advance. The design and specifications in this catalog are subject to change without prior notice.
- Do not use the products beyond the specifications described in this catalog.
- This catalog explains the quality and performance of the products as individual components. Before use, check and evaluate their operations when installed in your products.
- Install the following systems for a failsafe design to ensure safety if these products are to be used in equipment where a defect in these products may cause the loss of human life or other significant damage, such as damage to vehicles (automobile, train, vessel), traffic lights, medical equipment, aerospace equipment, electric heating appliances, combustion/gas equipment, rotating equipment, and disaster/crime prevention equipment.
- * Systems equipped with a protection circuit and a protection device
- * Systems equipped with a redundant circuit or other system to prevent an unsafe status in the event of a single fault

⚠ Precautions for use

1. Operation range and environments

- ① These products are designed and manufactured for general and standard use in general electronic equipment (e.g. AV equipment, home electric appliances, office equipment, information and communication equipment)
- ② These products are not intended for use in the following special conditions. Before using the products, carefully check the effects on their quality and performance, and determine whether or not they can be used.
 - In liquid, such as water, oil, chemicals, or organic solvent
 - In direct sunlight, outdoors, or in dust
 - In salty air or air with a high concentration of corrosive gas, such as Cl₂, H₂S, NH₃, SO₂, or NO₂
 - In an environment where these products cause dew condensation

2. Handling

- ① Do not bring magnets or magnetized materials close to the product. The influence of their magnetic field can change the inductance value.
- ② Do not apply strong mechanical shocks by either dropping or collision with other parts.
Excessive shock can damage the part.

3. Resoldering with a soldering iron

- ① Resoldering should be done within 3 seconds by soldering iron, the temperature with 350 °C or less and should be cooling down after ward. Both side of terminals shall be fixed closely to PWB. And terminals shall not be pressed in heating.

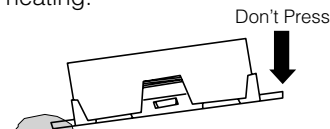

- ② The wiring tab shall not be held by sharp-edged tool.

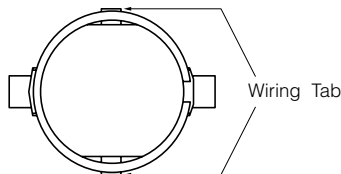

- ③ Iron shall not be put to the component itself.

4. Mounting side

- ① External force must be less than 4.9N while mounting.
- ② The wiring tab is expose the terminal, so please be careful when you design PWB pattern of coil circumference.

5. Cleaning

If you clean the inductor, please use own your ultrasonic cleaning to check specified conditions.













6. Storage conditions

Normal temperature (–5 to 35 °C), normal humidity (85 % RH max.), shall not be exposed to direct sunlight and harmful gases and care should be taken so as not to cause dew.

<Package markings>

Package markings include the product number, quantity, and country of origin.
In principle, the country of origin should be indicated in English.

■ Power Inductors (Multilayer type, Wire Wound type) · Selection Guide

No.	Dimensions (mm)		Type	Appearance	Inductance [L] (μH)					Rated Current I _{dc} (A)	
	External dimension (typ)	Height (max.)			1.0	10	100	1000	10000		
1	2.0 × 1.25	1.0	ELGTEA	Magunetic Shielded Type 	0.47 μH	4.7 μH				0.8 to 1.2	
2	2.5 × 2.0	1.2	ELLYFJ		0.47 μH	22 μH				0.37 to 2.15	
3		1.5	ELLYGJ			22 μH				0.43 to 1.70	
4	3.0	1.0	ELLVEG		0.68 μH	68 μH				0.18 to 1.80	
5		1.2	ELLVFG-C			33 μH				0.28 to 1.50	
6		1.5	ELLVGG			47 μH				0.27 to 1.80	
7		1.5	ELLVGG-C			100 μH				0.18 to 1.40	
8		1.2	ELL3FU				10 μH				0.65 to 1.90
9		1.2	ELL4FG-A				47 μH				0.29 to 1.90
10	3.8	ELL4GG		1.2 μH		100 μH			0.25 to 1.90		
11	1.8	ELL4LG-A				150 μH			0.22 to 1.90		
12	4.0	1.2	ELLSFG-A			470 μH			0.10 to 1.70		
13	5.0	2.0	ELL5PS		1.2 μH	560 μH			0.12 to 2.50		
14		2.0	ELL5PR		0.47 μH	22 μH			0.80 to 3.90		
15	6.0	1.6	ELL6GG			100 μH			0.30 to 2.50		
16		2.0	ELL6PG			0.8 μH	100 μH			0.38 to 2.80	
17	6.0 × 6.4	2.8	ELL6RH			220 μH			0.20 to 3.00		
18		3.3	ELL6SH			680 μH			0.16 to 3.40		
19		5.0	ELL6UH			10 μH	1000 μH			0.18 to 1.80	
20	8.0	5.0	ELL8TP		0.8 μH	1000 μH			0.25 to 9.00		
21	10.0	4.5	ELLATP			1000 μH			0.31 to 8.00		
22		4.5	ELLATV			1.5 μH	1000 μH			0.32 to 6.70	
23	12.0	4.5	ELLCTP			1.2 μH	1000 μH			0.40 to 7.00	
24		4.5	ELLCTV			1.2 μH	1000 μH			0.41 to 6.50	
25	4.0	1.2	ELCSFN-A		Non Magunetic Shielded Type 		22 μH			0.45 to 1.70	

* Please see the pages of each product for details of the electrical characteristics.

Design and specifications are each subject to change without notice. Ask factory for the current technical specifications before purchase and/or use.
Should a safety concern arise regarding this product, please be sure to contact us immediately.

Power Inductors / Multilayer type

Type: **ELGTEA**

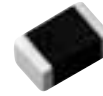

■ Features

- Superior DC current bias characteristics by the original laminating process technology
- Magnetic shielded structure
- Small and thin structure (2.0×1.25×1.0mm max.)
- RoHS compliant

■ Recommended Applications

- DC/DC converter circuit use of the small portable device
Smart phone, mobile phone, DSC .

■ Standard Packing Quantity

- 4000 pcs./Reel

■ Explanation of Part Numbers

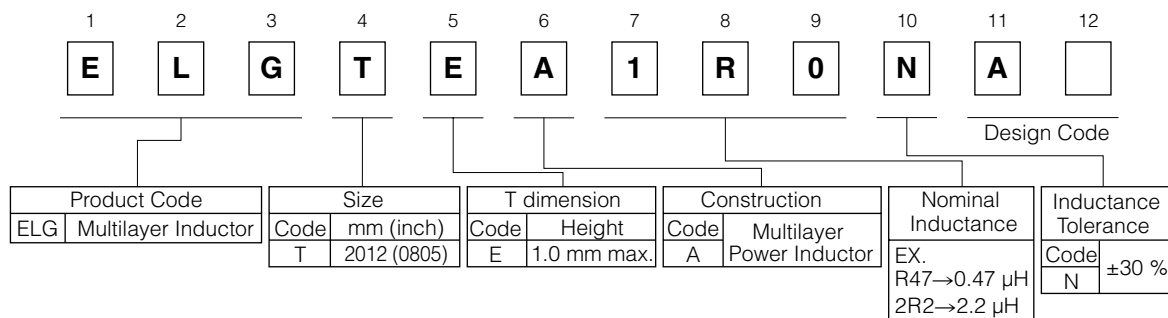

■ Dimensions in mm (not to scale)

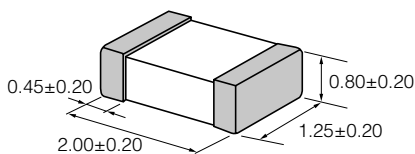

■ Recommended Land Pattern in mm (not to scale)

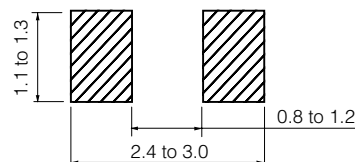

■ Ratings and Characteristics

Part Number	Inductance at 1 MHz		DC Resistance at 20 °C (Ω) max.	Rated Current*1 (A)	Self-resonant Frequency*2 (MHz)
	(μH)	Tol.			
ELGTEAR47NA	0.47	±30 %	0.10	1.2	126
ELGTEA1R0NA	1.0	±30 %	0.15	1.0	80
ELGTEA1R5NA	1.5	±30 %	0.18	1.0	80
ELGTEA2R2NA	2.2	±30 %	0.20	0.8	55
ELGTEA3R3NA	3.3	±30 %	0.25	0.8	50
ELGTEA4R7NA	4.7	±30 %	0.30	0.8	33

● Operating Temperature Range : -40 to 125 °C (Including self-temperature rise)

*1 This indicates the value of current when temperature rise dt/t=40 °C (at 20 °C).

*2 Reference data

■ Inductance frequency characteristics

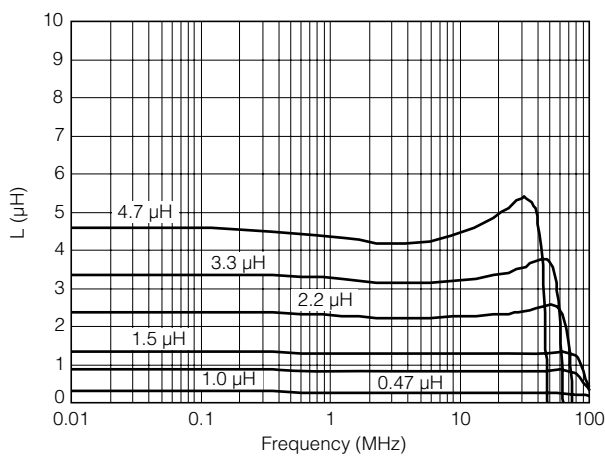

■ DC current bias characteristics

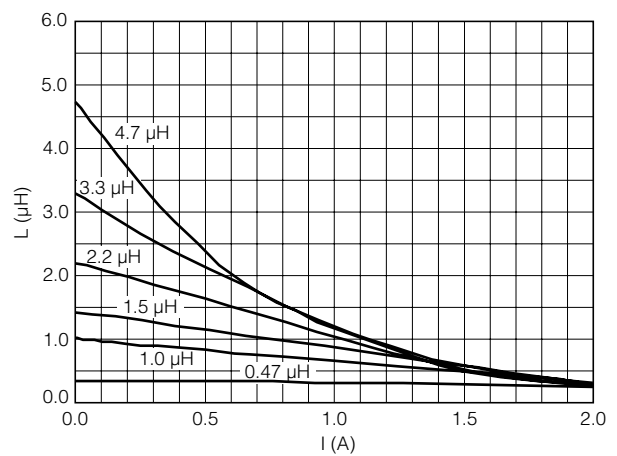

■ Packaging Methods (Taping)

● Punched Carrier Taping (Pitch 4mm)

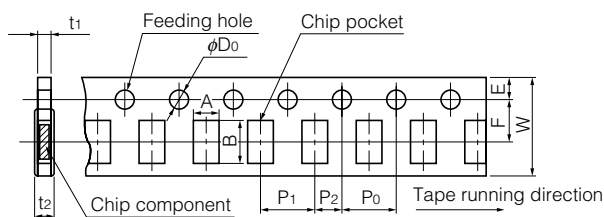

(Unit : mm)

Symbol	A	B	W	F	E	P ₁	P ₂	P ₀	φD ₀	t ₁	t ₂
Dim (mm)	1.65 ±0.20	2.4 ±0.2	8.0 ±0.2	3.50 ±0.05	1.75 ±0.10	4.0 ±0.1	2.00 ±0.05	4.0 ±0.1	1.5 +0.1/0	1.2 max.	1.4 max.

● Taping Reel

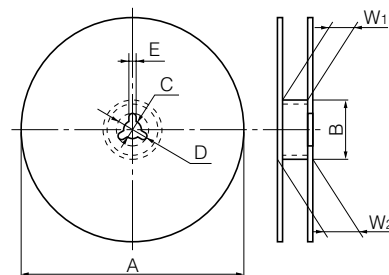

(Unit : mm)

Symbol	φA	φB	C	D	E	W ₁	W ₂
Dim (mm)	180 ^{-0.3}	60.0 ^{+1.0/0}	13.0±0.5	21.0±0.8	2.0±0.5	9.0 ^{+1.0/0}	11.4±1.0

● Leader Part and Taped End

Leader part

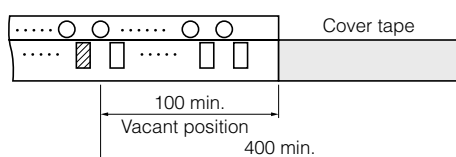

Taped end

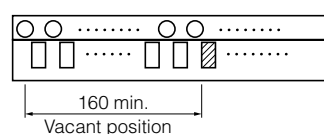

(Unit : mm)

Design and specifications are each subject to change without notice. Ask factory for the current technical specifications before purchase and/or use. Should a safety concern arise regarding this product, please be sure to contact us immediately.

Power Inductors / Multilayer type

Series: **ELGTEA**

Handling Precautions

⚠ Safety Precautions

Power Inductors / Multilayer type (hereafter referred to as "Inductors") should be used for general purpose applications in consumer electronics (audio/visual, home, office, information & communication) equipment. When subjected to severe electrical, environmental, and/or mechanical stress beyond the specifications, as noted in the Ratings and Specified Conditions section, the Inductors may fail.

For products which require high safety levels, please carefully consider how a single malfunction can affect your product. In order to ensure the safety in the case of a single malfunction, please design products with fail-safe, such as setting up protecting circuits, etc.

- For the following applications and conditions, please contact us for additional specifications not found in this document.
 - When your application may have difficulty complying with the safety or handling precautions specified below.
 - For any applications where a malfunction with this product may directly or indirectly cause hazardous conditions which could result in death or injury;
 - ① Aircraft and Aerospace Equipment (artificial satellite, rocket, etc.)
 - ② Submarine Equipment (submarine repeating equipment, etc.)
 - ③ Transport Equipment (motor vehicles, airplanes, trains, ship, traffic signal controllers, etc.)
 - ④ Power Generation Control Equipment (atomic power, hydroelectric power, thermal power plant control system, etc.)
 - ⑤ Medical Equipment (life-support equipment, pacemakers, dialysis controllers, etc.)
 - ⑥ Information Processing Equipment (large scale computer system, etc.)
 - ⑦ Electric Heating Appliances, Combustion devices (gas fan heaters, oil fan heaters, etc.)
 - ⑧ Rotary Motion Equipment
 - ⑨ Security Systems
 - ⑩ And any similar types of equipment

⚠ Strict Observance

1. Confirmation of Rated Performance

The Inductors shall be operated within the specified rating/performance.

Application exceeding the specifications may cause deteriorated performance and/or breakdown, resulting in degradation and/or smoking or ignition of products. The following are strictly observed.

- (1) The Inductors should be use within the specified operating temperature range including self-fever.
- (2) The electricity electric current of the inductor should be use in less than rated current.

2. The Inductors shall not be mounted near inflammables.

3. The inductors shall not be bring a magnet and the thing which became magnetized close.

■ Operating Conditions and Circuit Design

1. Circuit Design

1.1 Operating Temperature and Storage Temperature

The specified "Operating Temperature Range" found in the Specification is the absolute maximum and minimum temperature rating. Every Inductor shall be operated within the specified "Operating Temperature Range".

The Inductors mounted on PWB shall be stored without operating within the specified "Storage Temperature Range" in the Specifications.

1.2 Operating Current

The Inductors shall not be operated in excess of the "Rated current". In case of AC current is

superposed by DC current, the inductors shall be use the total current in rated current or less.

1.3 Self-heating

The surface temperature of the Inductors shall be under the specified Maximum Operating Temperature in the Specifications including the temperature rise cause by self-heating. Check temperature rise of the Inductor in your circuit.

1.4 Environmental Restrictions

The Inductors shall not be operated and/or stored under the following conditions.

- (1) Environmental conditions

- (a) Under direct exposure to water or salt water
 - (b) Under conditions where water can condense and/or dew can form
 - (c) Under conditions containing corrosive gases such as hydrogen sulfide, sulfurous acid, chlorine and ammonia
- (2) Mechanical conditions
Under severe conditions of vibration or impact beyond the specified conditions found in the Specifications.

2. Design of Printed Circuit Board

2.1 Selection of Printed Circuit Boards

When the Inductors are mounted and soldered on an "Alumina Substrate", the substrate influences the Inductors' reliability against "Temperature Cycles" and "Heat shock" due to the difference in the thermal expansion coefficient between them. Confirm that the actual board used does not deteriorate the characteristics of the Inductors.

2.2 Design of Land Pattern

- (1) Recommended land dimensions are shown below.
Use the proper amount of solder in order to prevent cracking. Using too much solder places excessive stress on the Inductors.

Recommended Land Dimensions

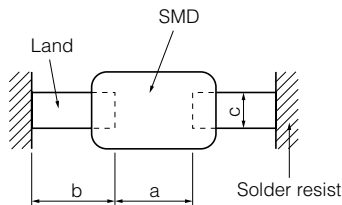

Unit (mm)

Size Code (inch)	Component dimensions			a	b	c
	L	W	T			
T(0805)	2.0	1.25	1.0 max.	0.8 to 1.2	0.6 to 1.1	1.1 to 1.3

- (2) The size of lands shall be designed to have equal spacing between the right and left sides. If the amount of solder on the right land is different from that on the left land, the component may be cracked by stress since the side with a larger amount of solder solidifies later during cooling.

Recommended Amount of Solder

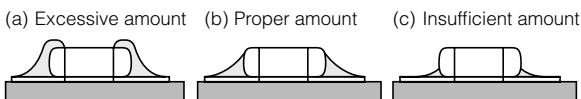

2.3 Utilization of Solder Resist

- (1) Solder resist shall be utilized to equalize the amounts of solder on both sides.
(2) Solder resist shall be used to divide the pattern for the following cases;
- Components are arranged closely.
 - The Inductor is mounted near a component with lead wires.
 - The Inductor is placed near a chassis.
- See the table below.

Prohibited Applications and Recommended Applications

Item	Prohibited applications	Improved applications by pattern division
Mixed mounting with a component with lead wires	The lead wire of a component with lead wires	Solder resist
Arrangement near chassis	Chassis Solder (Ground solder) Electrode pattern	Solder resist
Retro-fitting of component with lead wires	Soldering iron A lead wire of Retro-fitted component	Solder resist
Lateral arrangement	Portion to be excessively soldered Land	Solder resist

2.4 Component Layout

The Inductors/components shall be placed on the PC board such that both electrodes are subjected to uniform stresses, or to position the component electrodes at right angles to the grid glove or bending line. This should be done to avoid cracking the Inductors from bending the PC board after or during placing/mounting on the PC board.

- (1) To minimize mechanical stress caused by the warp or bending of a PC board, please follow the recommended Inductors' layout below.

Prohibited layout	Recommended layout
	Layout the Inductor sideways against the stressing direction.

(2) The following layout is for your reference since mechanical stress near the dividing/breaking position of a PC board varies depending on the mounting position of the Inductors.

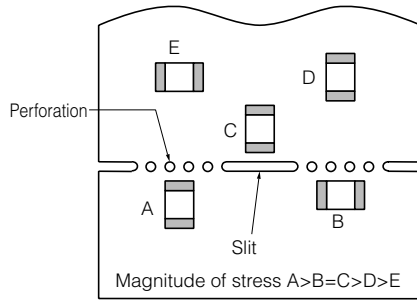

(3) The magnitude of mechanical stress applied to the Inductors when the circuit board is divided is in the order of push back < slit < V-groove < perforation. Also take into account the layout of the Inductors and the dividing/breaking method.

2.5 Mounting Density and Spaces

If components are arranged in too narrow a space, the components can be affected by solder bridges and solder balls. The space between components should be carefully determined.

■ Precautions for Assembly

1. Storage

- (1) The Inductors shall be stored between 5 - 40 °C and 20 - 70 %RH, not under severe conditions of high temperature and humidity.
- (2) If stored in a place that is humid, dusty, or contains corrosive gasses (hydrogen sulfide, sulfurous acid, hydrogen chloride and ammonia etc.), the solderability of terminal electrodes may deteriorate. In addition, storage in a place subjected to heating and/or exposure to direct sunlight will causes deformed tapes and reels, and component sticking to tapes, both of which can result in mounting problems.
- (3) Do not store components longer than 6 months. Check the solderability of products that have been stored for more than 6 months before use.

2. Adhesives for Mounting

- (1) The amount and viscosity of an adhesive for mounting shall be such that the adhesive shall not flow off on the land during its curing.
- (2) If the amount of adhesive is insufficient for mounting, the Inductors may fall off after or during soldering.
- (3) If the adhesive is too low in its viscosity, the Inductors may be out of alignment after or during soldering.

- (4) Adhesives for mounting can be cured by ultraviolet or infrared radiation. In order to prevent the terminal electrodes of the Inductors from oxidizing, the curing shall be done under the following conditions: 160 °C max., for 2 minutes max.
- (5) Insufficient curing may cause the Inductors to fall off after or during soldering. In addition, insulation resistance between terminal electrodes may deteriorate due to moisture absorption. In order to prevent these problems, please observe proper curing conditions.

3. Chip Mounting Consideration

- (1) When mounting the Inductors/components on a PC board, the Inductor bodies shall be free from excessive impact loads such as mechanical impact or stress due to the positioning, pushing force and displacement of vacuum nozzles during mounting.
- (2) Maintenance and inspection of the Chip Mounter must be performed regularly.
- (3) If the bottom dead center of the vacuum nozzle is too low, the Inductor will crack from excessive force during mounting.

The following precautions and recommendations are for your reference in use.

- (a) Set and adjust the bottom dead center of the vacuum nozzles to the upper surface of the PC board after correcting the warp of the PC board.
- (b) Set the pushing force of the vacuum nozzle during mounting to 1 to 3 N in static load.
- (c) For double surface mounting, apply a supporting pin on the rear surface of the PC board to suppress the bending of the PC board in order to minimize the impact of the vacuum nozzles. Typical examples are shown in the table below.

Item	Prohibited mounting	Recommended mounting
Single surface mounting	Crack	Supporting pin <small>The supporting pin does not necessarily have to be positioned beneath the Inductor.</small>
Double surface mounting	Separation of solder Crack	Supporting

- (d) Adjust the vacuum nozzles so that their bottom dead center during mounting is not too low.
- (4) The closing dimensions of the positioning chucks shall be controlled. Maintenance and replacement of positioning chucks shall be performed regularly to prevent chipping or cracking of the Inductors caused by mechanical impact during positioning due to worn positioning chucks.

(5) Maximum stroke of the nozzle shall be adjusted so that the maximum bending of PC board does not exceed 0.5mm at 90 mm span. The PC board shall be supported by an adequate number of supporting pins.

4. Selection of Soldering Flux

Soldering flux may seriously affect the performance of the Inductors. Please confirm whether soldering flux does not have an influence on performance of the Inductor before using enough.

5. Soldering

5.1 Reflow Soldering

The reflow soldering temperature conditions are each temperature curves of Preheating, Temp. rise, Heating, Peak and Gradual cooling. Large temperature difference caused by rapid heat application to the Inductors may lead to excessive thermal stresses, contributing to the thermal cracks. The Preheating temperature requires controlling with great care so that tombstone phenomenon may be prevented.

Item	Temperature	Period or Speed
① Preheating	140 to 180 °C	60 to 120 sec
② Temp. rise	Preheating temp to Peak temp.	2 to 5 °C /sec
③ Heating	220 °C min.	60 sec max.
④ Peak	260 °C max.	10 sec max.
⑤ Gradual cooling	Peak temp. to 140 °C	1 to 4 °C /sec

Recommended profile of Reflow soldering (EX)

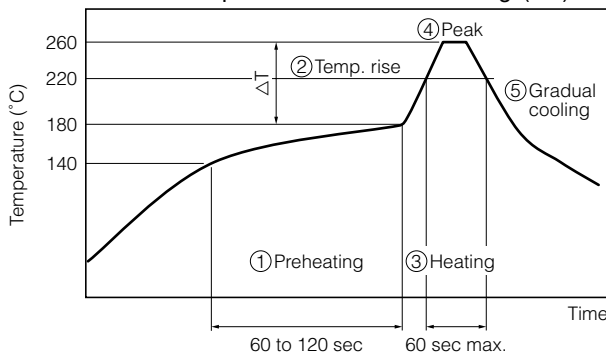

The rapid cooling (forced cooling) during Gradual cooling part should be avoided, because this may cause defects such as the thermal cracks, etc.

When the Inductors are immersed into a cleaning solvent, make sure that the surface temperatures of the devices do not exceed 100 °C.

Performing reflow soldering twice under the conditions shown in the figure above [Recommended profile of Reflow soldering (EX)] will not cause any problems. However, pay attention to the possible warp and bending of the PC board.

5.2 Hand Soldering

Hand soldering typically causes significant temperature change, which may induce excessive thermal stresses inside the Inductors, resulting in the thermal cracks, etc. In order to prevent any defects, the following should be observed;

- The temperature of the soldering tips should be controlled with special care.
- The direct contact of soldering tips with the Inductors and/or terminal electrodes should be avoided.
- Dismounted Inductors shall not be reused.

(1) Condition 1 (with preheating)

(a) Soldering :

ϕ 1.0 mm Thread eutectic solder with soldering flux* in the core.

* Rosin-based and non-activated flux is Recommended.

(b) Preheating :

The Inductors shall be preheated so that the "Temperature Gradient" between the devices and the tip of soldering iron is 150 °C or below.

(c) Temperature of Iron tip: 350 °C max.

(The required amount of solder shall be melted in advance on the soldering tip.)

(d) Gradual cooling :

After soldering, the Inductors shall be cooled gradually at room temperature.

Recommended profile of Hand soldering [EX]

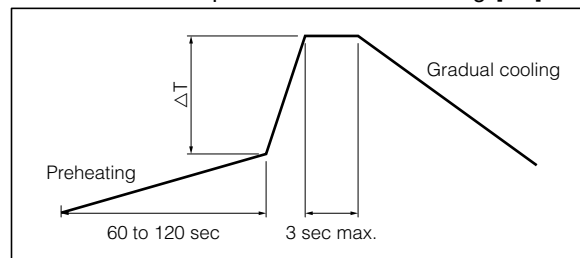

(2) Condition 2 (without preheating)

Hand soldering can be performed without preheating, by following the conditions below:

(a) Soldering iron tip shall never directly touch the ceramic and terminal electrodes of the Inductors.

(b) The lands are sufficiently preheated with a soldering iron tip before sliding the soldering iron tip to the terminal electrodes of the Inductors for soldering.

Conditions of Hand soldering without preheating

	Condition
Temperature of Iron tip	270 °C max.
Wattage	20 W max.
Shape of Iron tip	ϕ 3 mm max.
Soldering time with a soldering iron	3 sec max.

6. Post Soldering Cleaning

6.1 Cleaning solvent

Soldering flux residue may remain on the PC board if cleaned with an inappropriate solvent. This may deteriorate the electrical characteristics and reliability of the Inductors.

6.2 Cleaning conditions

Inappropriate cleaning conditions such as insufficient cleaning or excessive cleaning may impair the electrical characteristics and reliability of the Inductors.

- (1) Insufficient cleaning can lead to :
 - (a) The halogen substance found in the residue of the soldering flux may cause the metal of terminal electrodes to corrode.
 - (b) The halogen substance found in the residue of the soldering flux on the surface of the Inductors may change resistance values.
 - (c) Water-soluble soldering flux may have more remarkable tendencies of (a) and (b) above compared to those of rosin soldering flux.
- (2) Excessive cleaning can lead to :
 - (a) Overuse of ultrasonic cleaning may deteriorate the strength of the terminal electrodes or cause cracking in the solder and/or ceramic bodies of the Inductors due to vibration of the PC boards. Please follow these conditions for Ultrasonic cleaning :
 - Ultrasonic wave output : 20 W/L max.
 - Ultrasonic wave frequency : 40 kHz max.
 - Ultrasonic wave cleaning time : 5 min. max.

6.3 Contamination of Cleaning solvent

Cleaning with contaminated cleaning solvent may cause the same results as insufficient cleaning due to the high density of liberated halogen.

7. Inspection Process

When mounted PC boards are inspected with measuring terminal pins, abnormal and excess mechanical stress shall not be applied to the PC board or mounted components, to prevent failure or damage to the devices.

- (1) Mounted PC boards shall be supported by an adequate number of supporting pins with bend settings of 90 mm span 0.5 mm max.
 - (2) Confirm that the measuring pins have the right tip shape, are equal in height and are set in the correct positions.
- The following figures are for your reference to avoid bending the PC board.

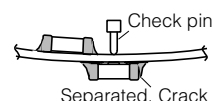
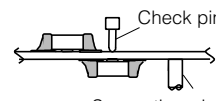
	Prohibited setting	Recommended setting
Bending of PC board		

8. Protective Coating

When the surface of a PC board on which the Inductors have been mounted is coated with resin to protect against moisture and dust, it shall be confirmed that the protective coating which is corrosive or chemically active is not used, in order that the reliability of the Inductors in the actual equipment may not be influenced. Coating materials that expand or shrink also may lead to damage to the Inductor during the curing process.

9. Dividing/Breaking of PC Boards

- (1) Abnormal and excessive mechanical stress such as bending or torsion shown below can cause cracking in the Inductors.

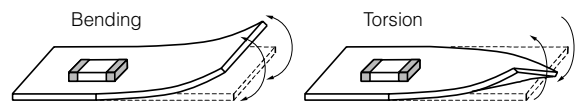

- (2) Dividing/Breaking of the PC boards shall be done carefully at moderate speed by using a jig or apparatus to prevent the Inductors on the boards from mechanical damage.

- (3) Examples of PWB dividing/breaking jigs :
The outline of PC board breaking jig is shown below.

When PC board are broken or divided, loading points should be close to the jig to minimize the extent of the bending.

Also, planes with no parts mounted on should be used as plane of loading, which generates a compressive stress on the mounted plane, in order to prevent tensile stress induced by the bending, which may cause cracks of the Inductors or other parts mounted on the PC boards.

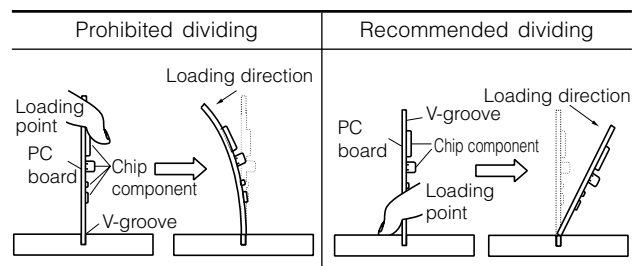
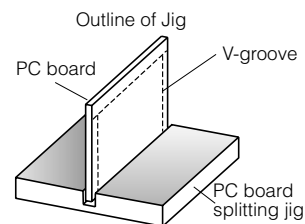

10. Mechanical Impact

- (1) The Inductors shall be free from any excessive mechanical impact. The Inductor body is made of ceramics and may be damaged or cracked if dropped. Never use an Inductor which has been dropped; their quality may be impaired and failure rate increased.
- (2) When handling PC boards with Inductors mounted on them, do not allow the Inductors to collide with another PC board. When mounted PC boards are handled or stored in a stacked state, impact between the corner of a PC board and the Inductor may cause damage or cracking and the inductor might lead to failure.

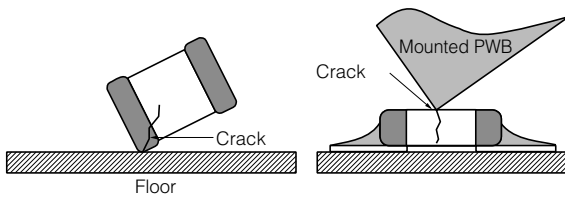

■ Other

The various precautions described above are typical. For special mounting conditions, please contact us.

Power Inductors / Wire Wound type

Series: **J**

Type: **ELLYFJ**
ELLYGJ

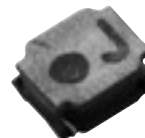

■ Features

- Small and low profile (2.5×2.0 mm)
- The magnetic shield effect is provided by adhesive with magnetic materials structure
- Low DC resistance and large current capability
- Shock resistant
- RoHS compliant

■ Recommended Applications

- DC/DC converter for smart phone , mobile phone, DSC, HDD

■ Standard Packing Quantity

- 3000 pcs./Reel

■ Soldering Conditions and Safety Precautions

Please see Data Files

■ Explanation of Part Numbers

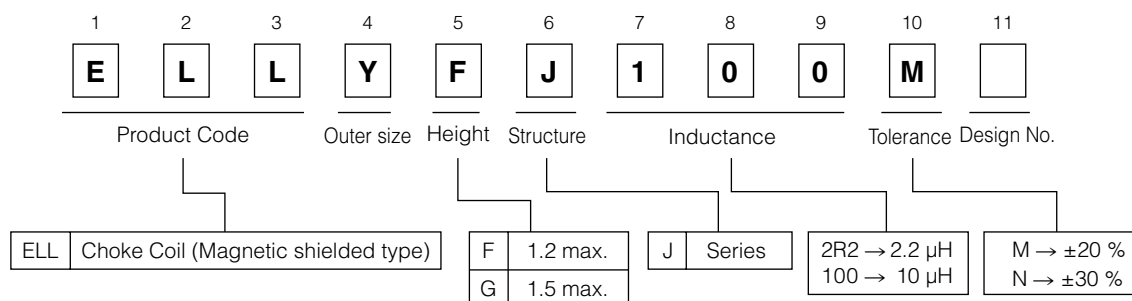

■ Dimensions in mm (not to scale)

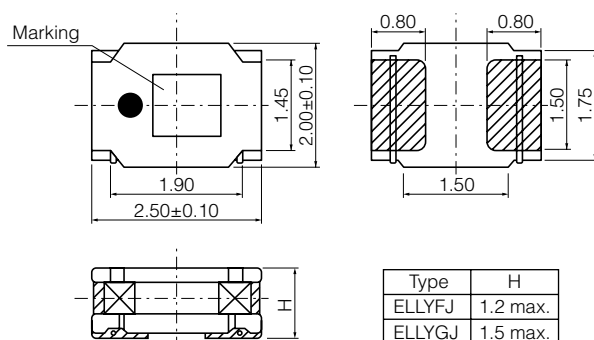

■ Recommended Land Pattern in mm (not to scale)

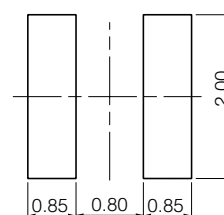

Standard Parts

Series	Part Number	Inductance (100 kHz)		R _{DC} (at 20 °C)		Saturation Rated Current* ¹ (mA max.)	Temperature Rise Current* ² (mA max.)	Marking
		(μH)	Tol.	(mΩ)	Tol.			
Series ELLYFJ	ELLYFJR47N	0.47	±30%	48	±20%	2500	2150	5
	ELLYFJ1R0N	1.0		73		2200	1750	A
	ELLYFJ1R5N	1.5		105		1750	1450	C
	ELLYFJ2R2M	2.2	±20%	130		1700	1300	D
	ELLYFJ3R3M	3.3		230		1200	980	E
	ELLYFJ4R7M	4.7		330		1080	820	H
	ELLYFJ5R6M	5.6		350		1000	800	J
	ELLYFJ6R8M	6.8		490		850	670	K
	ELLYFJ100M	10.0		620		730	600	M
	ELLYFJ150M	15.0		1000		590	470	O
	ELLYFJ220M	22.0		1650		400	370	R
Series ELLYGJ	ELLYGJ1R0N	1.0		±30%	68	±20%	2000	1700
	ELLYGJ2R2M	2.2	±20%	120	1700		1300	D
	ELLYGJ3R3M	3.3		180	1200		1050	E
	ELLYGJ4R7M	4.7		240	1100		900	H
	ELLYGJ5R6M	5.6		340	1000		770	J
	ELLYGJ6R8M	6.8		360	850		690	K
	ELLYGJ100M	10.0		550	720		600	M
	ELLYGJ150M	15.0		900	580		470	O
	ELLYGJ220M	22.0		1100	500		430	R

*1 Saturation Rated Current : This DC current which causes a 30 % inductance reduction from its nominal value.

*2 Temperature Rise Current : This indicates the value of current when temperature rise dt/t= 40 °C (at 20 °C).

Embossed Carrier Tape Dimensions in mm (not to scale)

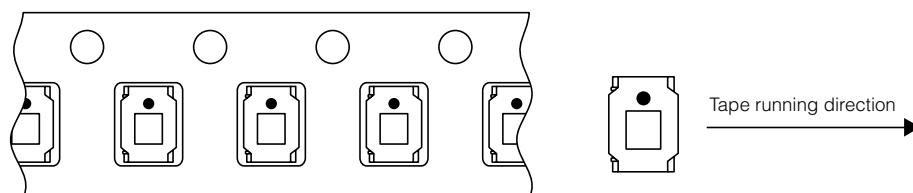
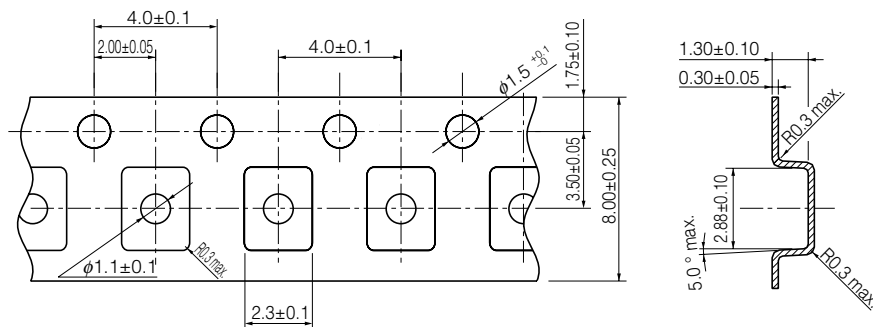

Design and specifications are each subject to change without notice. Ask factory for the current technical specifications before purchase and/or use. Should a safety concern arise regarding this product, please be sure to contact us immediately.

Power Inductors / Wire Wound type

Series: **G**
 Type: **ELLVEG**
ELLVFG-C
ELLVGG
ELLVGG-C

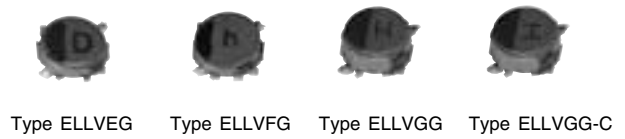

■ Features

- Magnetic shielded structure
- Low DC resistance and large current capability
- Shock resistant
- RoHS compliant

■ Recommended Applications

- DC-DC converter circuitry for computer peripherals and cellular phones.
- Chopper circuit decoupling chokes for DC-DC converter circuitry.

■ Standard Packing Quantity

- 2000 pcs./Reel

■ Soldering Conditions and Safety Precautions

Please see Data Files

■ Explanation of Part Numbers

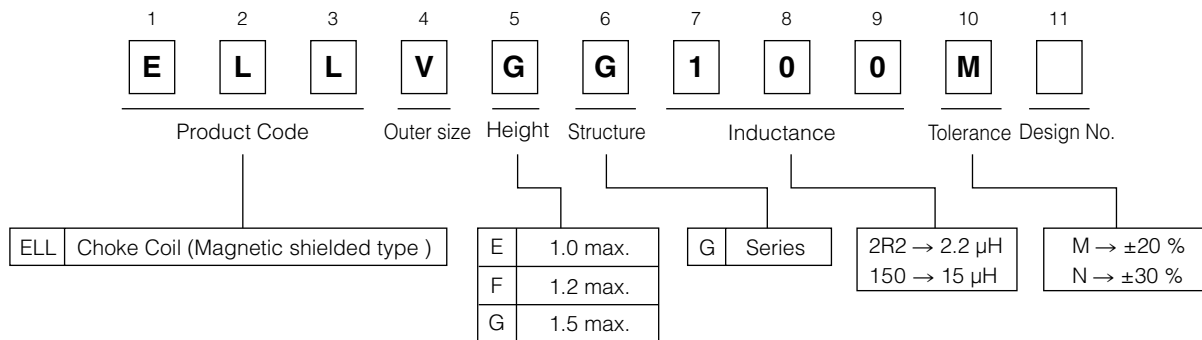

■ Dimensions in mm (not to scale)

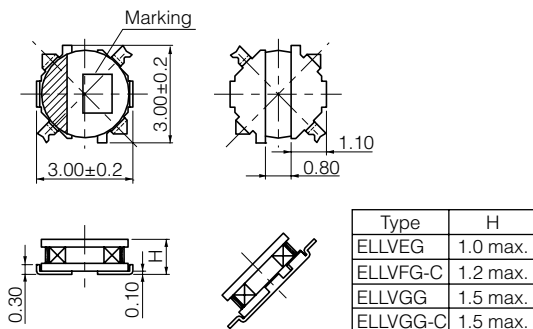

■ Recommended land patterns in mm (not to scale)

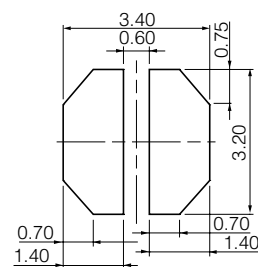

Standard Parts

Series	Part Number	Inductance (100 kHz)		R _{DC} (at 20 °C)		Saturation Rated Current*1 (mA max.)	Temperature Rise Current*2 (mA max.)	Marking			
		(μH)	Tol.	(mΩ)	Tol.						
Series VEG	ELLVEGR68N	0.68	±30 %	50	±20 %	1950	1800	7			
	ELLVEG1R0N	1.0		61		1900	1600	A			
	ELLVEG1R5N	1.5		74		1200	1400	C			
	ELLVEG2R2N	2.2		110		1100	1250	D			
	ELLVEG3R3N	3.3		210		1000	820	E			
	ELLVEG4R7N	4.7		240		750	770	H			
	ELLVEG6R8N	6.8		350		580	650	K			
	ELLVEG100M	10.0	±20 %	480		520	600	M			
	ELLVEG150M	15.0		710		430	490	O			
	ELLVEG220M	22.0		1200		330	400	R			
	ELLVEG330M	33.0		2300		260	290	T			
	ELLVEG470M	47.0		2700		220	250	V			
	ELLVEG680M	68.0		3500		180	220	X			
	Series VFG-C	ELLVFG1R0NC		1.0		±30 %	50	±20 %	1500	1700	a
ELLVFG1R5NC		1.5	61	1300	1550		c				
ELLVFG2R2NC		2.2	87	1100	1400		d				
ELLVFG3R3NC		3.3	110	980	1250		e				
ELLVFG4R7NC		4.7	150	740	1050		h				
ELLVFG6R8NC		6.8	230	600	840		k				
ELLVFG100MC		10.0	±20 %	380	550		640		m		
ELLVFG150MC		15.0		540	500	480	o				
ELLVFG220MC		22.0		710	350	430	r				
ELLVFG330MC		33.0		1160	280	330	t				
Series VGG		ELLVGG1R0N		1.0	±30 %	52	±20 %		2200	1800	A
		ELLVGG1R2N		1.2		61			2000	1600	B
		ELLVGG1R6N		1.6		73			1800	1550	C
		ELLVGG2R2N	2.2	92		1600			1400	D	
	ELLVGG3R3N	3.3	130	1350		1100		E			
	ELLVGG3R9N	3.9	150	1300		1000		F			
	ELLVGG4R7N	4.7	170	1200		980		H			
	ELLVGG6R8N	6.8	230	1000	800	K					
	ELLVGG100M	10.0	±20 %	280	800	730		M			
	ELLVGG120M	12.0		480	690	580		N			
	ELLVGG150M	15.0		640	600	490		O			
	ELLVGG220M	22.0		800	500	460		R			
	ELLVGG330M	33.0		1330	450	340		T			
	ELLVGG470M	47.0		2100	350	270		V			
Series VGG-C	ELLVGG1R0NC	1.0		±30 %	47	±20 %	1400	2000	A		
	ELLVGG2R2NC	2.2	79		1050		1500	D			
	ELLVGG3R3NC	3.3	110		1000		1300	E			
	ELLVGG4R7NC	4.7	130		900		1200	H			
	ELLVGG6R8NC	6.8	180		700		1000	K			
	ELLVGG100MC	10.0	±20 %	260	600		860	M			
	ELLVGG120MC	12.0		280	550		730	N			
	ELLVGG150MC	15.0		420	450		670	O			
	ELLVGG220MC	22.0		530	410		600	R			
	ELLVGG330MC	33.0		790	350		450	T			
	ELLVGG470MC	47.0		1200	260		360	V			
	ELLVGG101MC	100		2950	180		250	Z			

*1 Saturation Rated Current : This DC current which causes a 30 % inductance reduction from its nominal value.

*2 Temperature Rise Current : This indicates the value of current when temperature rise dt/t= 40 °C (at 20 °C).

■ Embossed Carrier Tape Dimensions in mm (not to scale)

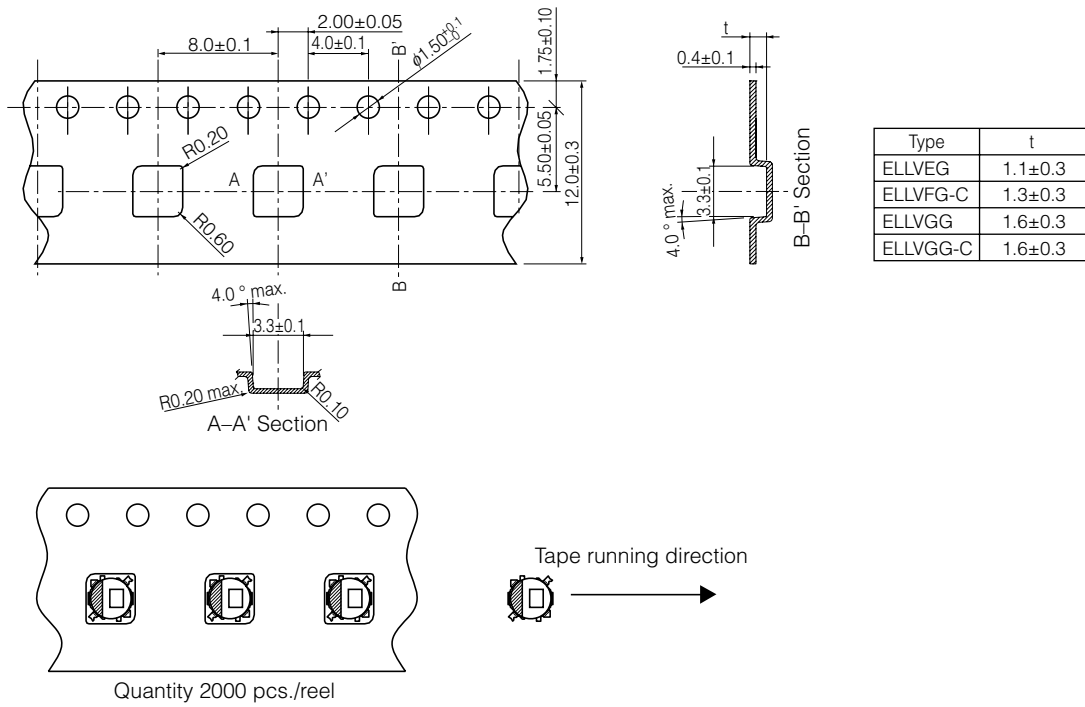

Power Inductors / Wire Wound type

Series: **U**
 Type: **ELL3FU**



■ Features

- A high performance is achieved by improvement of winding space factor by the rectangular wire and the original winding industrial method
 High performance was actualized by the application of flat wire winding and ring coreless structure
- The magnetic shield effect is provided by adhesive with magnetic materials structure
- Low profile
- RoHS compliant

■ Recommended Applications

- Choke coil for smoothness of DC/DC of mobile device
- Mobile Phone, DSC, HDD, MID, Net-Book

■ Standard Packing Quantity

- 2000 pcs./Reel

■ Soldering Conditions and Safety Precautions

Please see Data Files.

■ Explanation of Part Numbers

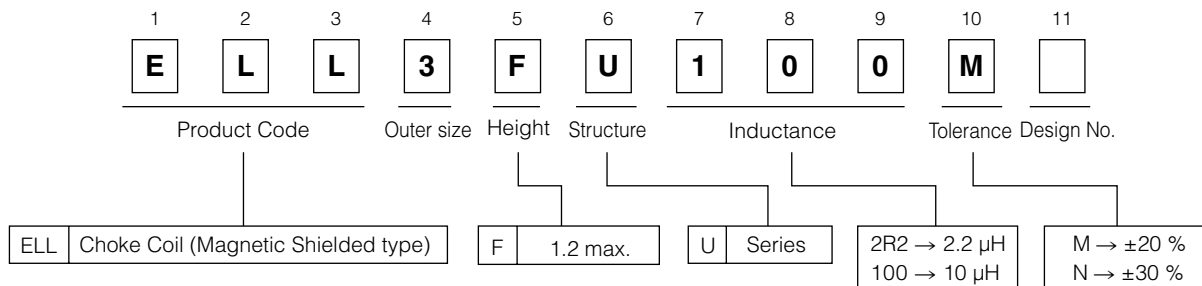

■ Dimensions in mm (not to scale)

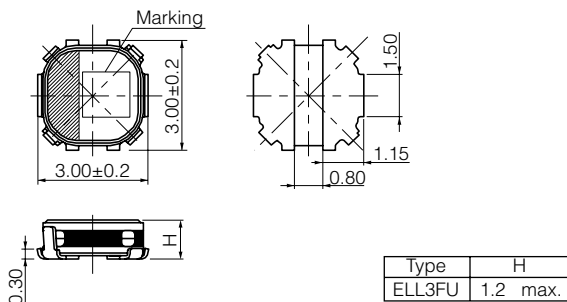

■ Recommended land patterns in mm (not to scale)

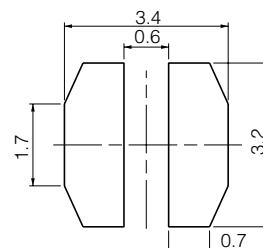

Standard Parts

Part Number	Inductance (100 kHz)		R _{DC} (at 20 °C)		Saturation Rated Current* ¹ (mA max.)	Temperature Rise Current* ² (mA max.)	Marking
	(μH)	Tol.	(mΩ)	Tol.			
ELL3FU1R0N	1.0	±30 %	53	±20 %	2300	1900	A
ELL3FU1R5N	1.5		66		C		
ELL3FU2R2N	2.2		76		D		
ELL3FU2R2NB	2.2		120		d		
ELL3FU3R3N	3.3		140		E		
ELL3FU4R7N	4.7	±20 %	160		1000	1000	H
ELL3FU100M	10.0		300		650	800	M

*1 Saturation Rated Current: This DC current which causes a 30% inductance reduction from its nominal value.

*2 Temperature Rise Current : This indicates the value of current when temperature rise dt/t= 40 °C (at 20 °C).

Embossed Carrier Tape Dimensions in mm (not to scale)

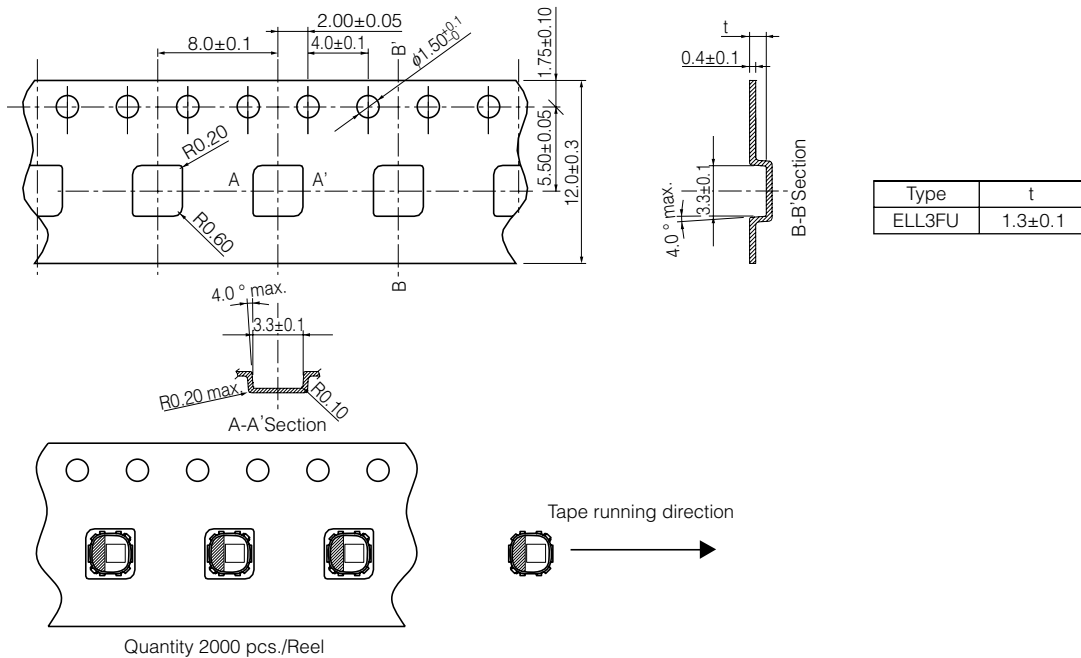

Power Inductors / Wire Wound type

Series: **G**
 Type: **ELL4FG-A**
ELL4GG
ELL4LG-A



Features

- Magnetic shielded structure
- Low DC resistance and large current capability
- Shock resistant
- RoHS compliant

Recommended Applications

- DC-DC converter circuitry for computer peripherals and cellular phones.
- Chopper circuit decoupling chokes for DC-DC converter circuitry.

Standard Packing Quantity

- 2000 pcs./Reel (ELL4FG-A/ELL4GG)
- 3000 pcs./Reel (ELL4LG-A)

Soldering Conditions and Safety Precautions

Please see Data Files.

Explanation of Part Numbers

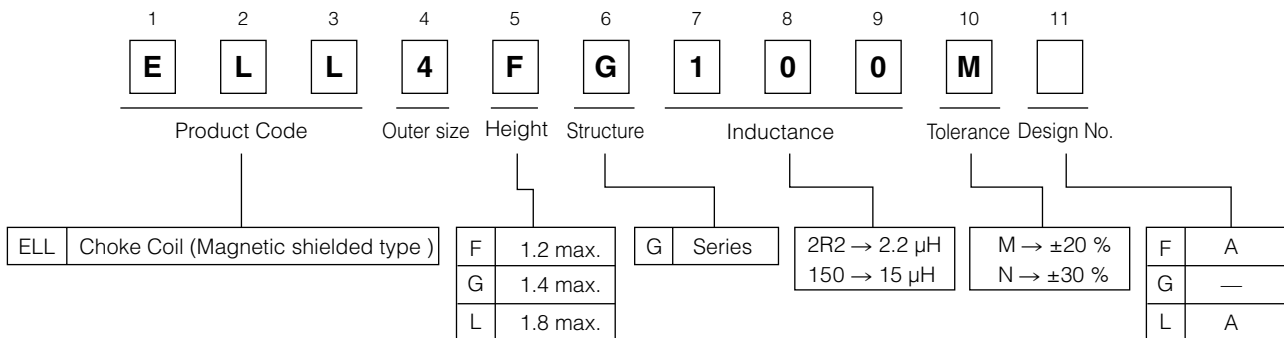

Dimensions in mm (not to scale)

- ELL4FG-A
- ELL4LG-A

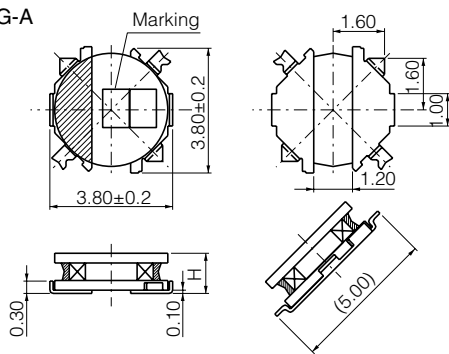

Type	H
ELL4FG-A	1.1±0.10 (1.20 max.)
ELL4LG-A	1.80 max.

- ELL4GG

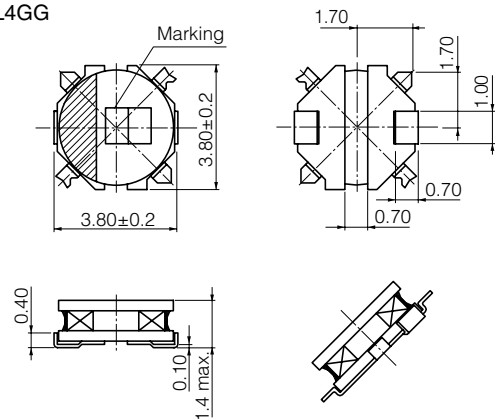

Recommended land patterns in mm (not to scale)

- ELL4FG-A
- ELL4LG-A

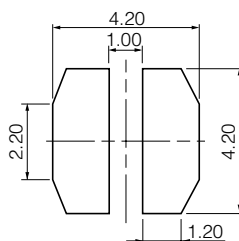

- ELL4GG

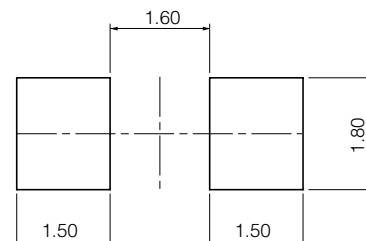

Standard Parts

Series	Part Number	Inductance (100 kHz)		R _{DC} (at 20 °C)		Saturation Rated Current* ¹ (mA max.)	Temperature Rise Current* ² (mA max.)	Marking
		(μH)	Tol.	(mΩ)	Tol.			
Series 4FG-A	ELL4FG1R0NA	1.0	±30 %	45	±20 %	1900	1950	01
	ELL4FG1R5NA	1.5		60		1600	1700	06
	ELL4FG2R0NA	2.0		70		1300	1550	10
	ELL4FG3R3NA	3.3		110		1100	1220	16
	ELL4FG4R7NA	4.7		160		1000	1000	21
	ELL4FG6R8NA	6.8	220	800		860	26	
	ELL4FG100MA	10.0	±20 %	290		700	750	31
	ELL4FG150MA	15.0		480		600	580	33
	ELL4FG220MA	22.0		620		420	500	36
	ELL4FG330MA	33.0		1060		360	400	39
ELL4FG470MA	47.0	1600		290	330	51		
Series 4GG	ELL4GG1R2N	1.2	±30 %	50	±20 %	2400	1900	03
	ELL4GG1R8N	1.8		71		1900	1550	09
	ELL4GG2R2N	2.2		88		1700	1400	11
	ELL4GG3R3N	3.3		110		1500	1200	16
	ELL4GG3R9N	3.9		120		1400	1150	19
	ELL4GG4R7N	4.7		160		1200	1000	21
	ELL4GG5R6N	5.6	170	1100		970	23	
	ELL4GG6R8N	6.8	200	1050		930	26	
	ELL4GG8R2N	8.2	220	1000		870	29	
	ELL4GG100M	10.0	±20 %	250		900	770	31
	ELL4GG120M	12.0		380		800	650	32
	ELL4GG150M	15.0		500		700	580	33
	ELL4GG220M	22.0		640		600	500	36
	ELL4GG330M	33.0		980		450	400	39
	ELL4GG470M	47.0		1250		400	350	51
	ELL4GG101M	100.0	2400	290		250	56	
Series 4LG-A	ELL4LG1R0NA	1.0	±30 %	43	±20 %	2200	1900	01
	ELL4LG1R5NA	1.5		48		1700	1800	06
	ELL4LG2R2NA	2.2		55		1500	1700	11
	ELL4LG2R7NA	2.7		63		1400	1550	13
	ELL4LG3R3NA	3.3		72		1300	1450	16
	ELL4LG4R7NA	4.7		90		1100	1300	21
	ELL4LG6R2NA	6.2	140	930		1100	25	
	ELL4LG100MA	10.0	±20 %	200		800	950	31
	ELL4LG150MA	15.0		300		620	730	33
	ELL4LG220MA	22.0		390		550	640	36
	ELL4LG330MA	33.0		610		430	510	39
	ELL4LG470MA	47.0		920		360	410	51
	ELL4LG680MA	68.0		1300		270	350	53
	ELL4LG101MA	100.0		2200		250	260	56
ELL4LG151MA	150.0	3000		220	220	59		

*1 Saturation Rated Current : This DC current which causes a 30 % inductance reduction from its nominal value.

*2 Temperature Rise Current : This indicates the value of current when temperature rise dt/t= 40 °C (at 20 °C).

Embossed Carrier Tape Dimensions in mm (not to scale)

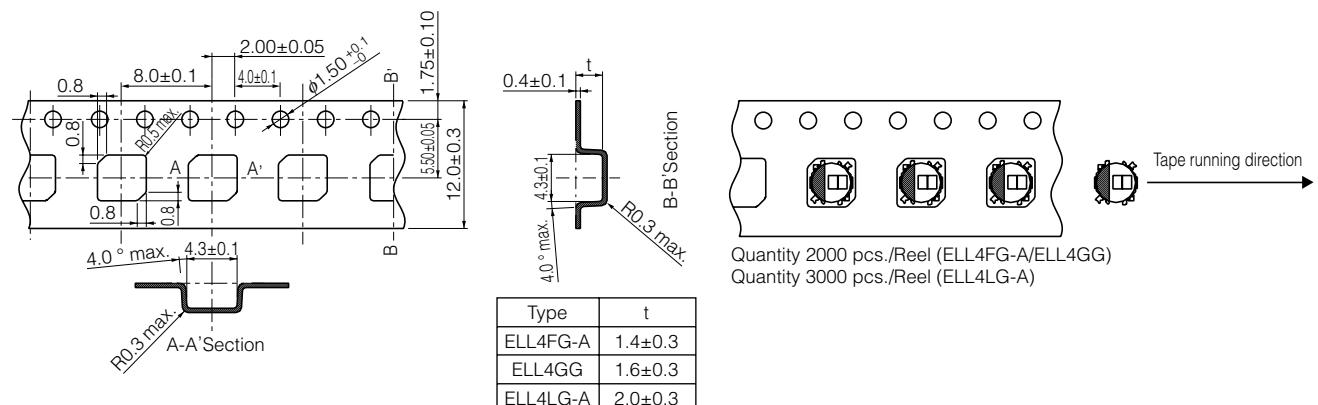

Design and specifications are each subject to change without notice. Ask factory for the current technical specifications before purchase and/or use.
Should a safety concern arise regarding this product, please be sure to contact us immediately.

Power Inductors / Wire Wound type

Series: **G**
 Type: **ELLSFG-A**

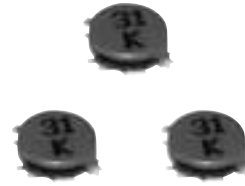

■ Features

- Magnetic shielded structure
- Low DC resistance and large current capability
- Shock resistant
- RoHS compliant

■ Recommended Applications

- DC-DC converter circuitry for computer peripherals and cellular phones.
- Chopper circuit decoupling chokes for DC-DC converter circuitry.

■ Standard Packing Quantity

- 2000 pcs./Reel

■ Soldering Conditions and Safety Precautions

Please see Data Files

■ Explanation of Part Numbers

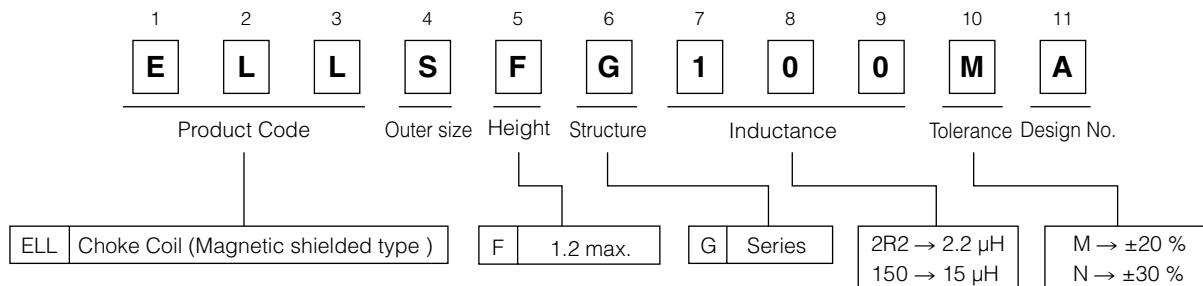

■ Dimensions in mm (not to scale)

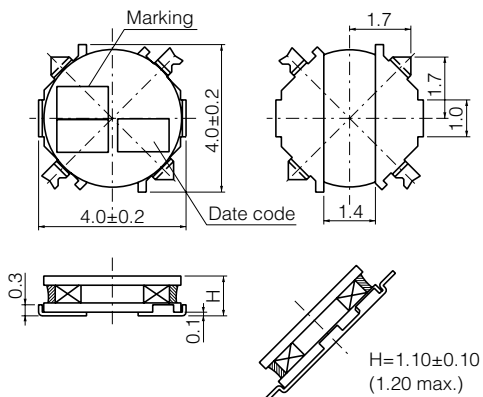

■ Recommended land patterns in mm (not to scale)

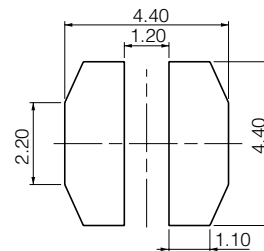

Standard Parts

Part Number	Inductance (100 kHz)		R _{DC} (at 20 °C)		Saturation Rated Current* ¹ (mA max.)	Temperature Rise Current* ² (mA max.)	Marking
	(μH)	Tol.	(mΩ)	Tol.			
ELLSFG1R0NA	1.0	±30 %	49	±20 %	1800	1700	01
ELLSFG1R2NA	1.2		58		1700	1550	03
ELLSFG2R2NA	2.2		79		1300	1350	11
ELLSFG3R3NA	3.3		110		1100	1150	16
ELLSFG4R7NA	4.7		130		1000	1100	21
ELLSFG6R8NA	6.8		180		800	950	26
ELLSFG100MA	10.0	±20 %	230		740	800	31
ELLSFG150MA	15.0		390		500	650	33
ELLSFG220MA	22.0		520		470	580	36
ELLSFG330MA	33.0		860		350	410	39
ELLSFG470MA	47.0		1150		300	350	51
ELLSFG560MA	56.0		1300		290	330	52
ELLSFG680MA	68.0		1500		270	310	53
ELLSFG820MA	82.0		2000		220	270	55
ELLSFG101MA	100.0		2400		210	240	56
ELLSFG121MA	120.0		3100		200	210	57
ELLSFG151MA	150.0		3800		190	190	59
ELLSFG181MA	180.0		4300		180	180	65
ELLSFG221MA	220.0	6700	140	145	66		
ELLSFG331MA	330.0	8900	130	128	69		
ELLSFG471MA	470.0	12300	100	110	71		

*1 Saturation Rated Current : This DC current which causes a 30 % inductance reduction from its nominal value.

*2 Temperature Rise Current : This indicates the value of current when temperature rise dt/t= 40 °C (at 20 °C).

Embossed Carrier Tape Dimensions in mm (not to scale)

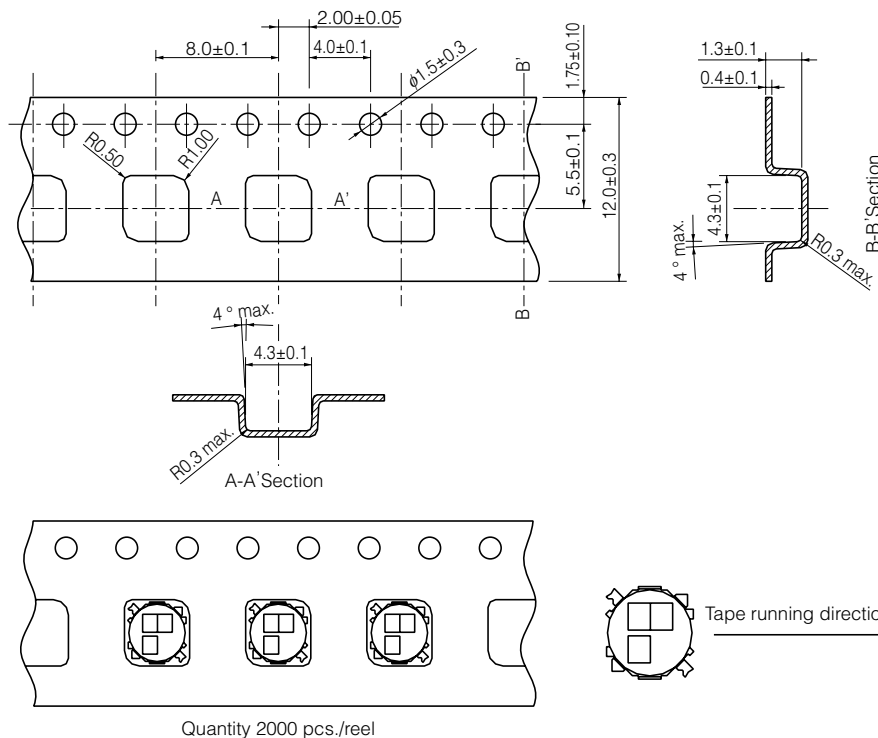

Design and specifications are each subject to change without notice. Ask factory for the current technical specifications before purchase and/or use. Should a safety concern arise regarding this product, please be sure to contact us immediately.

Power Inductors / Wire Wound type

Series: **S**
 Type: **ELL5PS**



■ Features

- Magnetic shielded structure
- Low DC resistance and large current capability
- RoHS compliant

■ Recommended Applications

- DC-DC converter circuitry for computer peripherals and cellular phones.
- Chopper circuit decoupling chokes for DC-DC converter circuitry

■ Standard Packing Quantity

- 2000 pcs./Reel

■ Soldering Conditions and Safety Precautions

Please see Data Files

■ Explanation of Part Numbers

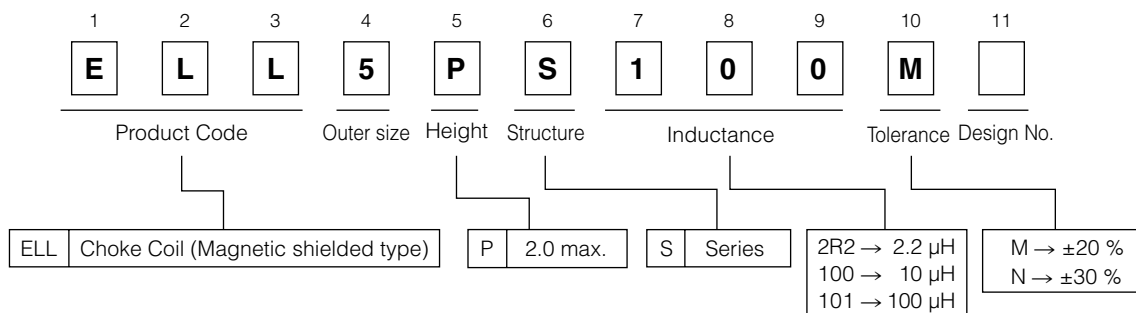

■ Dimensions in mm (not to scale)

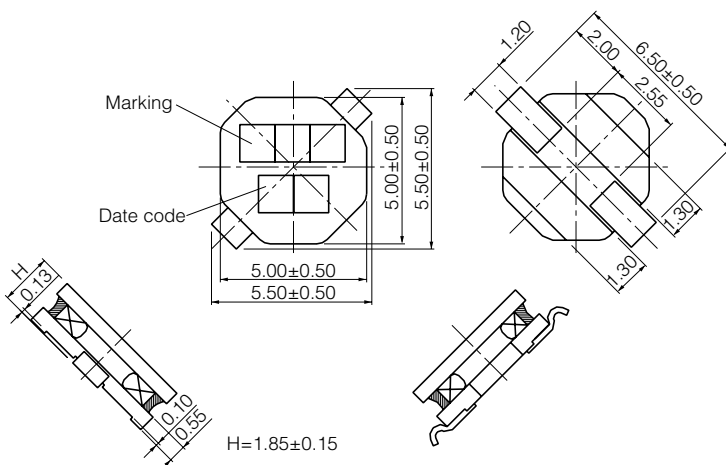

■ Recommended Land Pattern in mm (not to scale)

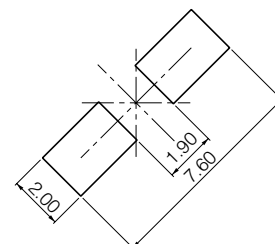

Standard Parts

Part Number	Inductance (100 kHz)		RDC (at 20 °C)		Saturation Rated Current* ¹ (mA max.)	Temperature Rise Current* ² (mA max.)	Marking
	(μH)	Tol.	(mΩ)	Tol.			
ELL5PS1R2N	1.2	±30 %	22	±20 %	2500	2500	1R2
ELL5PS1R5N	1.5		28		2400	2400	1R5
ELL5PS2R2N	2.2		34		2100	2100	2R2
ELL5PS2R7N	2.7		40		2000	2050	2R7
ELL5PS3R3N	3.3		46		1900	2000	3R3
ELL5PS4R7N	4.7		61		1500	1600	4R7
ELL5PS6R8N	6.8		96		1280	1280	6R8
ELL5PS100M	10.0	±20 %	120	±20 %	1000	1100	100
ELL5PS150M	15.0		170		790	1000	150
ELL5PS220M	22.0		290		650	750	220
ELL5PS330M	33.0		470		490	490	330
ELL5PS470M	47.0		620		450	550	470
ELL5PS560M	56.0		680		430	500	560
ELL5PS680M	68.0		750		380	480	680
ELL5PS820M	82.0		1160		340	360	820
ELL5PS101M	100.0		1320		300	340	101
ELL5PS221M	220.0		3450		210	210	221
ELL5PS331M	330.0		4700		180	180	331
ELL5PS471M	470.0		8100		160	140	471
ELL5PS561M	560.0		9500		150	125	561

*1 Saturation Rated Current : This DC current which causes a 30 % inductance reduction from its nominal value.

*2 Temperature Rise Current : This indicates the value of current when temperature rise dt/t= 40 °C (at 20 °C).

Embossed Carrier Tape Dimensions in mm (not to scale)

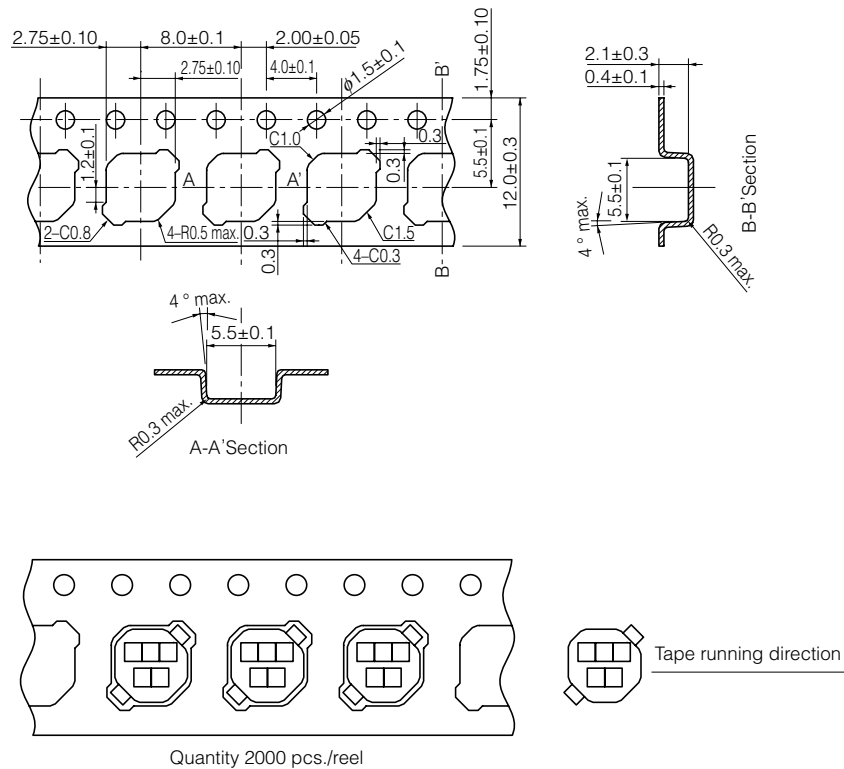

Design and specifications are each subject to change without notice. Ask factory for the current technical specifications before purchase and/or use. Should a safety concern arise regarding this product, please be sure to contact us immediately.

Power Inductors / Wire Wound type

Series: **R**

Type: **ELL5PR**



■ Features

- Magnetic shielded structure
- Low DC resistance and large current capability
- Adopted a rectangular core
- RoHS compliant

■ Recommended Applications

- DC-DC converter circuitry for computer peripherals and cellular phones.
- Chopper circuit decoupling chokes for DC-DC converter circuitry

■ Standard Packing Quantity

- 2000 pcs./Reel

■ Soldering Conditions and Safety Precautions

Please see Data Files.

■ Explanation of Part Numbers

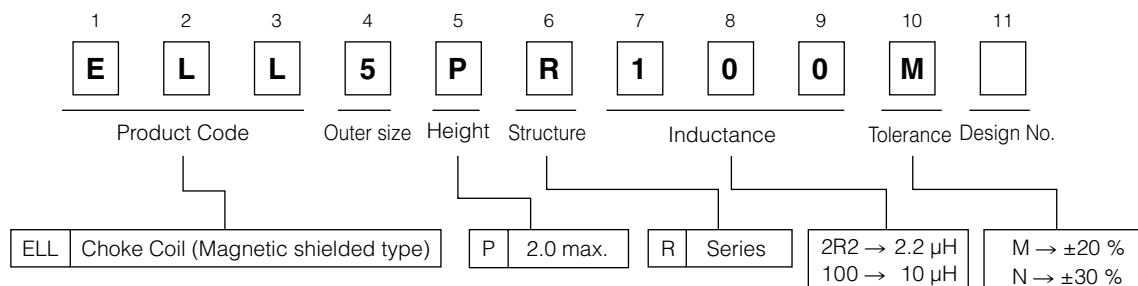

■ Dimensions in mm (not to scale)

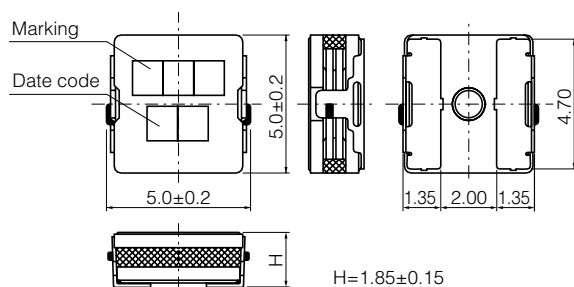

■ Recommended Land Pattern in mm (not to scale)

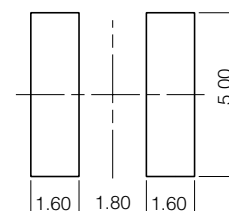

Standard Parts

Part Number	Inductance (100 kHz)		R _{DC} (at 20 °C)		Saturation Rated Current ^{*1} (mA max.)	Temperature Rise Current ^{*2} (mA max.)	Marking
	(μH)	Tol.	(mΩ)	Tol.			
ELL5PRR47N	0.47	±30%	12	±20%	5500	3900	R47
ELL5PR1R0N	1.0		21		4500	3000	1R0
ELL5PR1R2N	1.2		21		4200	3000	1R2
ELL5PR1R5N	1.5		25		4000	2850	1R5
ELL5PR2R2N	2.2		32		3200	2400	2R2
ELL5PR3R3N	3.3		37		2600	2300	3R3
ELL5PR4R7N	4.7		56		2200	1800	4R7
ELL5PR6R8N	6.8		85		1700	1400	6R8
ELL5PR100M	10.0	±20%	150		1400	1060	100
ELL5PR150M	15.0		190		1200	1000	150
ELL5PR220M	22.0		290		950	800	220

*1 Saturation Rated Current : This DC current which causes a 30 % inductance reduction from its nominal value.

*2 Temperature Rise Current : This indicates the value of current when temperature rise dt/t= 40 °C (at 20 °C).

Embossed Carrier Tape Dimensions in mm (not to scale)

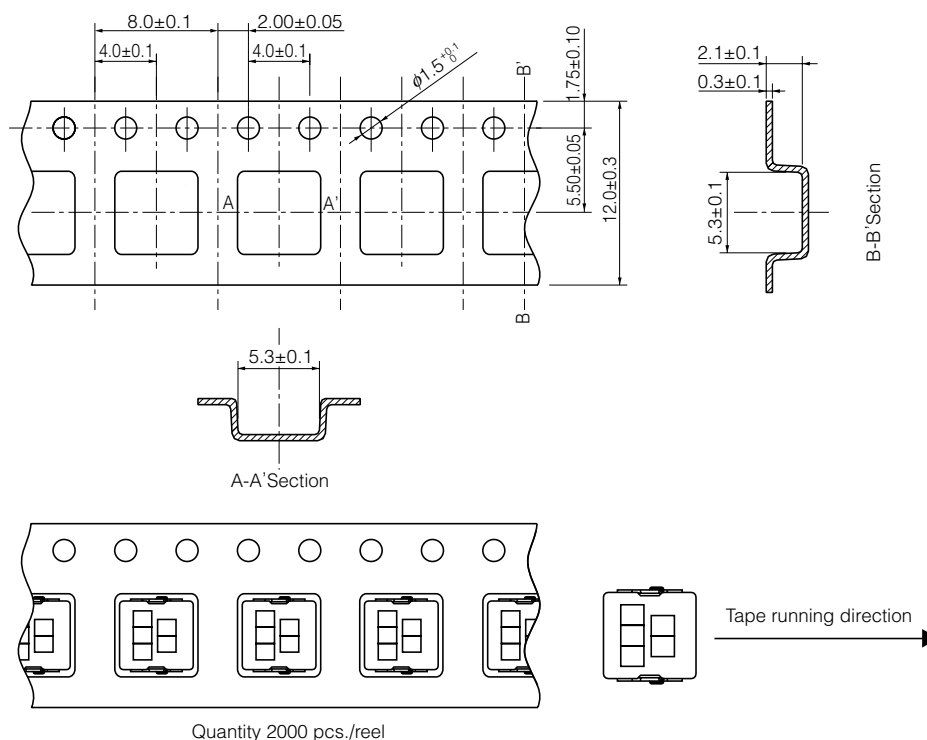

Power Inductors / Wire Wound type

Series: **G**
 Type: **ELL6GG**
ELL6PG



■ Features

- Magnetic shielded structure
- Low DC resistance and large current capability
- RoHS compliant

■ Recommended Applications

- DC-DC converter circuitry for computer peripherals and cellular phones.
- Chopper circuit decoupling chokes for DC-DC converter circuitry.

■ Standard Packing Quantity

- 1000 pcs./Reel

■ Soldering Conditions and Safety Precautions

Please see Data Files.

■ Explanation of Part Numbers

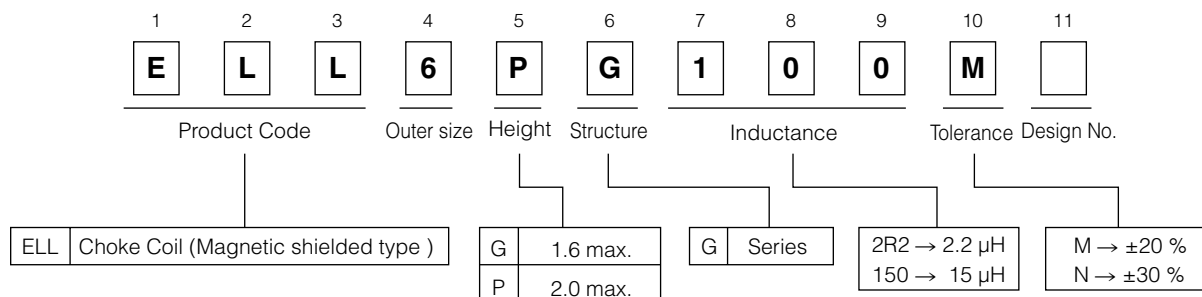

■ Dimensions in mm (not to scale)

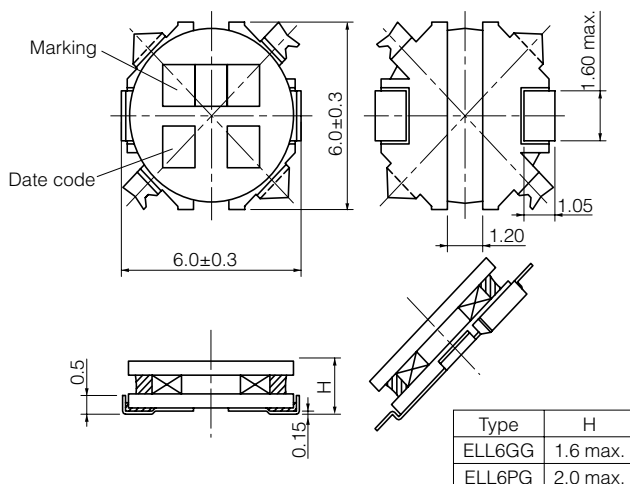

■ Recommended land patterns in mm (not to scale)

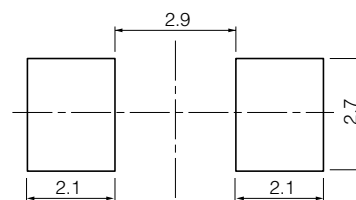

Standard Parts

Series	Part Number	Inductance (100 kHz)		R _{DC} (at 20 °C)		Saturation Rated Current* ¹ (mA max.)	Temperature Rise Current* ² (mA max.)	Marking
		(μH)	Tol.	(mΩ)	Tol.			
Series 6GG	ELL6GG1R0N	1.0	±30 %	27	±20 %	2500	2500	1R0
	ELL6GG1R5N	1.5		36		2300	2250	1R5
	ELL6GG2R2M	2.2		45		1950	2000	2R2
	ELL6GG2R7M	2.7	54	1850		1800	2R7	
	ELL6GG3R9M	3.9	60	1650		1700	3R9	
	ELL6GG4R7M	4.7	70	1400		1550	4R7	
	ELL6GG6R8M	6.8	110	1150		1300	6R8	
	ELL6GG100M	10.0	170	900		1000	100	
	ELL6GG150M	15.0	210	800		900	150	
	ELL6GG220M	22.0	300	620		850	220	
	ELL6GG330M	33.0	510	490		580	330	
	ELL6GG470M	47.0	610	400		480	470	
	ELL6GG680M	68.0	860	380		410	680	
	ELL6GG101M	100.0	1480	300		350	101	
Series 6PG	ELL6PGR08N	0.8	±30 %	24	±20 %	3800	2800	R08
	ELL6PG1R5N	1.5		30		2500	2500	1R5
	ELL6PG2R2N	2.2		37		2200	2200	2R2
	ELL6PG3R3N	3.3		44		1700	2000	3R3
	ELL6PG3R9N	3.9		51		1600	1900	3R9
	ELL6PG4R7N	4.7		58		1500	1750	4R7
	ELL6PG5R6N	5.6		65		1450	1650	5R6
	ELL6PG6R8N	6.8		70		1400	1600	6R8
	ELL6PG100M	10.0	110	1300		1300	100	
	ELL6PG120M	12.0	140	1100		1200	120	
	ELL6PG150M	15.0	150	1000		1100	150	
	ELL6PG220M	22.0	230	800		900	220	
	ELL6PG270M	27.0	260	730		800	270	
	ELL6PG330M	33.0	300	700		750	330	
	ELL6PG470M	47.0	470	550		600	470	
	ELL6PG560M	56.0	520	500		550	560	
	ELL6PG680M	68.0	700	420		500	680	
	ELL6PG820M	82.0	800	400		450	820	
ELL6PG101M	100.0	1000	380	400	101			

*1 Saturation Rated Current : This DC current which causes a 30 % inductance reduction from its nominal value.

*2 Temperature Rise Current : This indicates the value of current when temperature rise dt/t= 40 °C (at 20 °C).

Embossed Carrier Tape Dimensions in mm (not to scale)

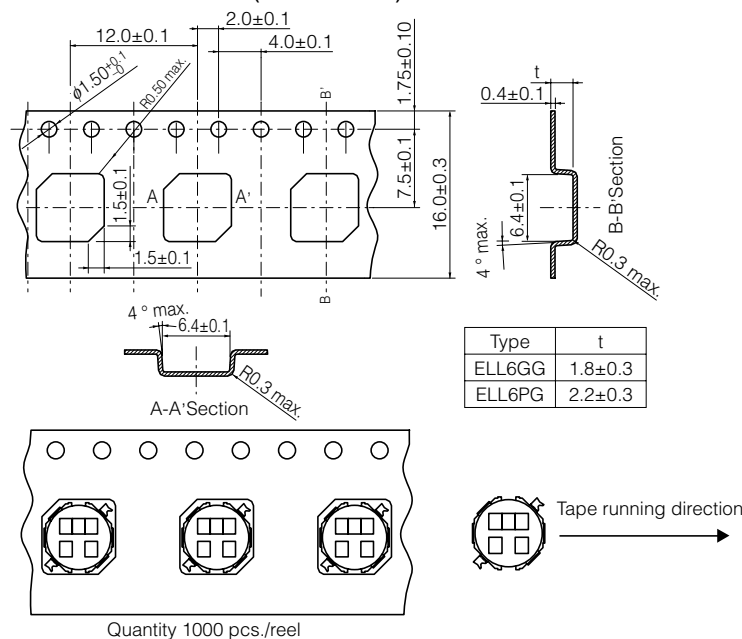

Design and specifications are each subject to change without notice. Ask factory for the current technical specifications before purchase and/or use. Should a safety concern arise regarding this product, please be sure to contact us immediately.

Power Inductors / Wire Wound type

Series: **H**
 Type: **ELL6RH**
ELL6SH
ELL6UH

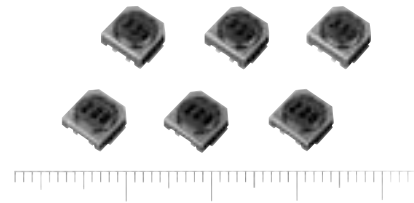

■ Features

- Thin (height 2.5 mm, 3.0 mm)
- Higher reliability in mounting by separating the user terminal and internal connection.
- Large current capability
- RoHS compliant

■ Recommended Applications

- Video, Audio, Mobile communications, Electric battery driven equipment
- As a decoupling choke coil in DC-DC converters

■ Cautionary Notes Regarding Usage in DC-DC converters

- Maximum Dissipation of 1 W.
- Maximum case temperature of 105 °C (Ambient & self-heating temperature)

■ Standard Packing Quantity

- 1000 pcs./Reel

■ Soldering Conditions and Safety Precautions

Please see Data Files.

■ Explanation of Part Numbers

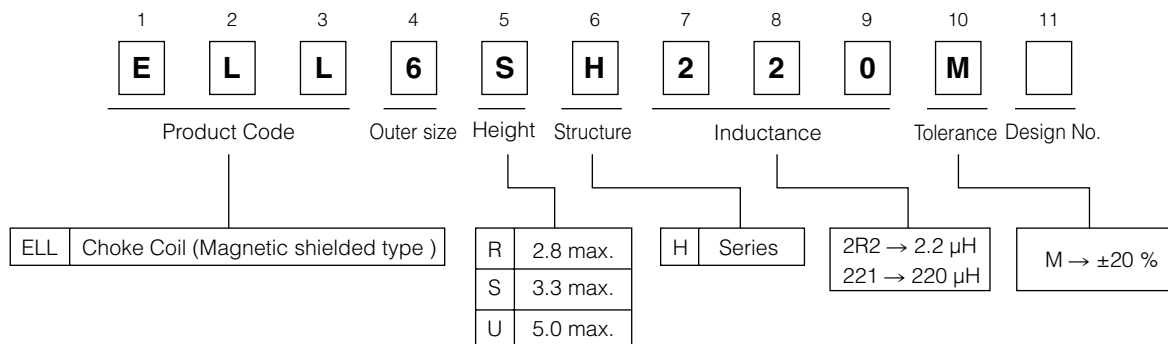

■ Dimensions in mm (not to scale)

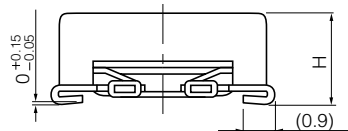
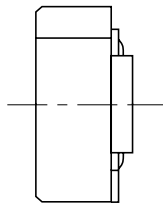
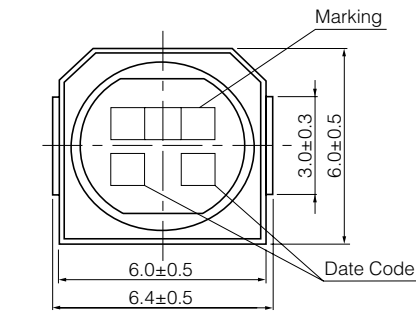

Type	H
ELL6RH	2.5 mm±0.3 mm
ELL6SH	3.0 mm±0.3 mm
ELL6UH	5.0 mm max.

■ Connections (Top view)

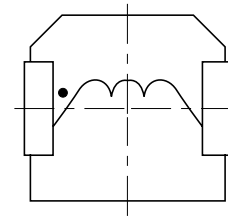

■ Recommended Land Pattern in mm (not to scale)

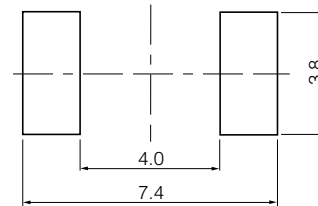

■ Standard Parts

Part Number	Inductance (μH) at 100 kHz Tol. ±20 %	RDC (mΩ) at 20 °C Tol. ±20 %		* Rated Current (mA) max.		Marking
		6RH	6SH	6RH	6SH	
ELL6□H1R0M	1.0	19	19	3000	3400	1R0
ELL6□H1R5M	1.5	24	24	2400	3200	1R5
ELL6□H2R0M	2.0	—	26	—	2600	2R0
ELL6□H2R2M	2.2	30	—	2300	—	2R2
ELL6□H2R7M	2.7	39	31	1800	2400	2R7
ELL6□H3R3M	3.3	44	34	1600	2200	3R3
ELL6□H4R7M	4.7	49	42	1580	2000	4R7
ELL6□H5R1M	5.1	56	—	1550	—	5R1
ELL6□H5R6M	5.6	—	49	—	1800	5R6
ELL6□H6R2M	6.2	62	—	1400	—	6R2
ELL6□H6R8M	6.8	—	52	—	1500	6R8
ELL6□H7R5M	7.5	80	—	1250	—	7R5
ELL6□H8R2M	8.2	87	61	1200	1400	8R2
ELL6□H100M	10.0	95	65	1100	1300	100
ELL6□H120M	12.0	130	71	1000	1200	120
ELL6□H150M	15.0	150	96	850	1100	150
ELL6□H180M	18.0	170	130	800	1000	180
ELL6□H220M	22.0	220	140	700	900	220
ELL6□H270M	27.0	260	160	650	800	270
ELL6□H330M	33.0	380	180	600	700	330
ELL6□H390M	39.0	410	240	550	650	390
ELL6□H470M	47.0	480	270	500	600	470
ELL6□H560M	56.0	540	290	450	550	560
ELL6□H680M	68.0	770	520	400	500	680
ELL6□H820M	82.0	870	600	350	450	820
ELL6□H101M	100.0	1000	680	300	400	101
ELL6□H121M	120.0	1500	750	280	370	121
ELL6□H151M	150.0	1800	860	250	350	151
ELL6□H181M	180.0	2000	1300	230	300	181
ELL6□H221M	220.0	2300	1400	200	280	221
ELL6□H271M	270.0	—	2400	—	260	271
ELL6□H331M	330.0	—	2700	—	240	331
ELL6□H391M	390.0	—	2800	—	210	391
ELL6□H471M	470.0	—	3200	—	200	471
ELL6□H561M	560.0	—	3700	—	180	561
ELL6□H681M	680.0	—	4300	—	160	681

* Current: This indicates the value of current when the inductance is 80% of nominal value or when the case temperature has risen 45 °C.

Design and specifications are each subject to change without notice. Ask factory for the current technical specifications before purchase and/or use.
Should a safety concern arise regarding this product, please be sure to contact us immediately.

Standard Parts

Part No.	Inductance (μH) at 100 kHz Tolerance $\pm 20\%$	R_{DC} ($\text{m}\Omega$) at 20 °C Tolerance $\pm 20\%$	* Rated Current (mA) max.	Marking
ELL6UH100M	10.0	63	1800	100
ELL6UH120M	12.0	71	1700	120
ELL6UH150M	15.0	79	1600	150
ELL6UH180M	18.0	88	1400	180
ELL6UH220M	22.0	98	1300	220
ELL6UH270M	27.0	110	1200	270
ELL6UH330M	33.0	130	1100	330
ELL6UH390M	39.0	150	1000	390
ELL6UH470M	47.0	160	900	470
ELL6UH560M	56.0	210	800	560
ELL6UH680M	68.0	230	700	680
ELL6UH820M	82.0	260	650	820
ELL6UH101M	100.0	360	600	101
ELL6UH121M	120.0	480	580	121
ELL6UH151M	150.0	680	500	151
ELL6UH181M	180.0	750	470	181
ELL6UH221M	220.0	840	410	221
ELL6UH271M	270.0	1200	370	271
ELL6UH331M	330.0	1360	330	331
ELL6UH391M	390.0	1500	300	391
ELL6UH471M	470.0	1680	270	471
ELL6UH561M	560.0	2530	260	561
ELL6UH681M	680.0	2830	240	681
ELL6UH821M	820.0	3140	200	821
ELL6UH102M	1000.0	3670	180	102

* Current: This indicates the value of current when the inductance is 70% of nominal value or when the case temperature has risen 45 °C.

Embossed Carrier Tape Dimensions in mm (not to scale)

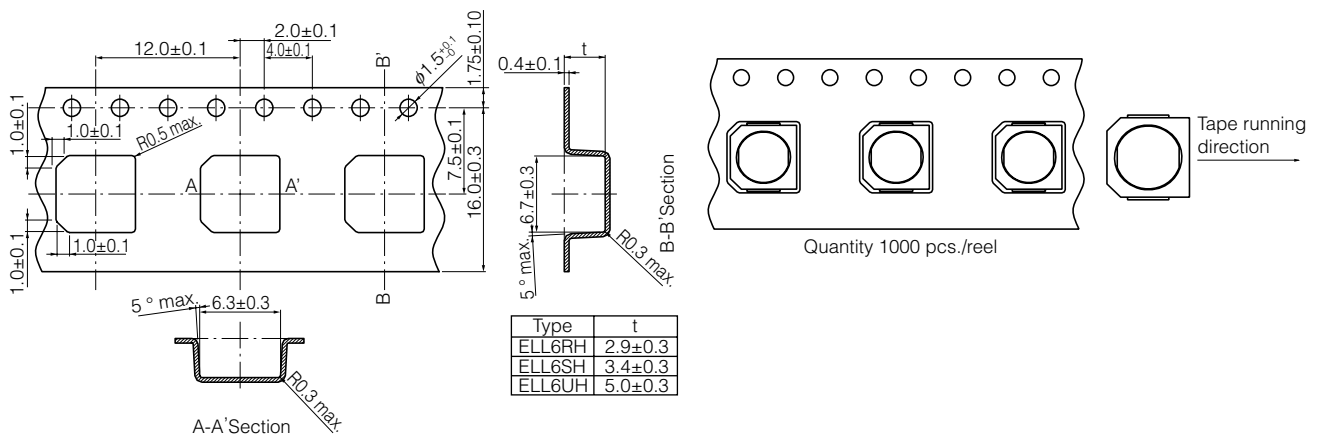

Design and specifications are each subject to change without notice. Ask factory for the current technical specifications before purchase and/or use. Should a safety concern arise regarding this product, please be sure to contact us immediately.

Power Inductors / Wire Wound type

Series: **P**
 Type: **ELL8TP**



■ Features

- Magnetic shielded structure
- Low DC resistance and large current capability
- Available on tape and reel for automatic insertion
- RoHS compliant

■ Recommended Applications

- DC-DC converter circuitry for computer peripherals and amusement equipment.
- Chopper circuit decoupling chokes for DC-DC converter circuitry.

■ Standard Packing Quantity

- 500 pcs./Reel

■ Soldering Conditions and Safety Precautions

Please see Data Files

■ Explanation of Part Numbers

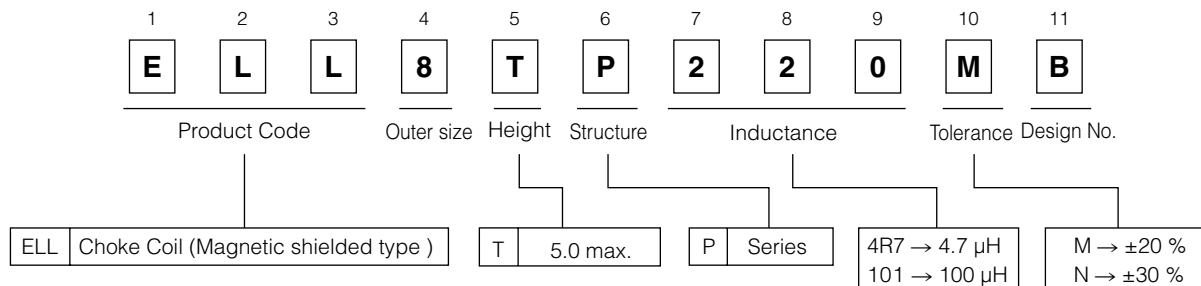

■ Dimensions in mm (not to scale)

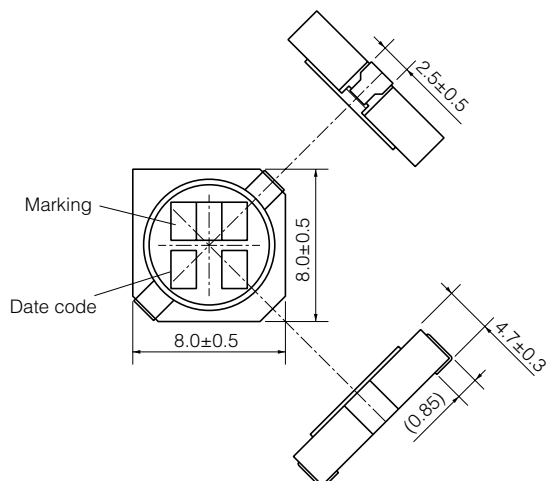

■ Recommended Land Pattern in mm (not to scale)

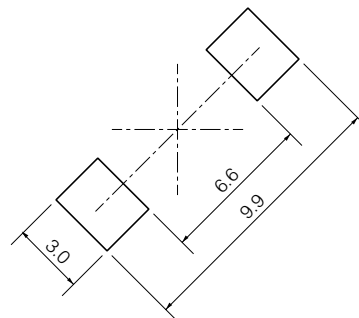

Standard Parts

Part Number	Inductance (100 kHz)		R _{DC} (at 20 °C)		Saturation Rated Current* ¹ (mA max.)	Temperature Rise Current* ² (mA max.)	Marking
	(μH)	Tol.	(mΩ)	Tol.			
ELL8TPR80NB	0.8	±30 %	3.6	±30 %	9500	9000	R80
ELL8TP1R2NB	1.2		4.7		8500	8000	1R2
ELL8TP2R5NB	2.5		7		5500	6500	2R5
ELL8TP3R3NB	3.3		13		5000	4200	3R3
ELL8TP4R7NB	4.7		14		4000	4000	4R7
ELL8TP6R8NB	6.8		18		3500	3500	6R8
ELL8TP100MB	10.0	±20 %	25	±20 %	3000	3000	100
ELL8TP150MB	15.0		44		2300	2300	150
ELL8TP220MB	22.0		55		2200	2000	220
ELL8TP330MB	33.0		84		1600	1600	330
ELL8TP470MB	47.0		100		1400	1500	470
ELL8TP680MB	68.0		140		1000	1300	680
ELL8TP101MB	100.0		190		900	1100	101
ELL8TP151MB	150.0		340		700	800	151
ELL8TP221MB	220.0		480		550	700	221
ELL8TP331MB	330.0		700		450	570	331
ELL8TP471MB	470.0		1000		400	480	471
ELL8TP681MB	680.0		1300		300	430	681
ELL8TP102MB	1000.0	2100	250	330	102		

*1 Saturation Rated Current: This DC current which causes a 30% inductance reduction from its nominal value.

*2 Temperature Rise Current : This indicates the value of current when temperature rise dt/t= 40 °C (at 20 °C).

Embossed Carrier Tape Dimensions in mm (not to scale)

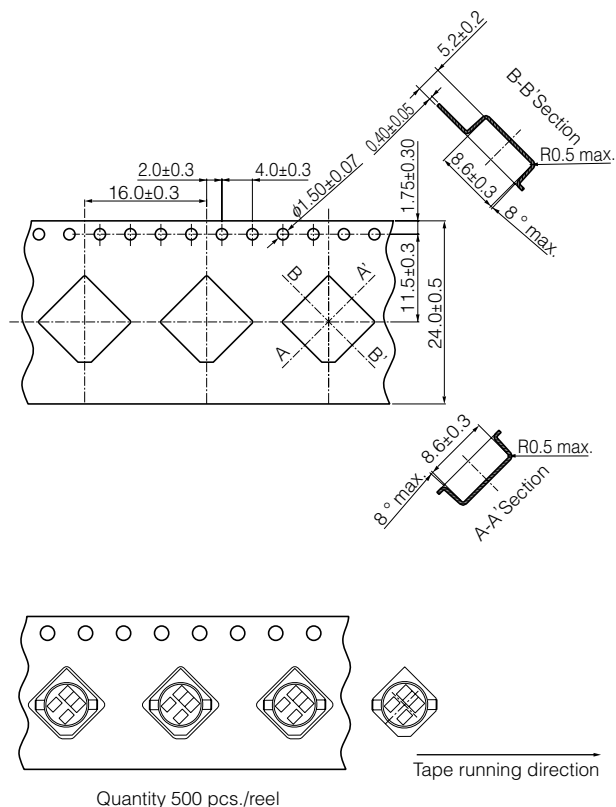

Power Inductors / Wire Wound type

Series: **P**
 Type: **ELLATP**



■ Features

- Magnetic shielded structure
- Low DC resistance and large current capability
- Available on tape and reel for automatic insertion
- The new version of ELLATV serie
- RoHS compliant

■ Recommended Applications

- DC-DC converter circuitry for computer peripherals and amusement equipment.
- Chopper circuit decoupling chokes for DC-DC converter circuitry.

■ Standard Packing Quantity

- 500 pcs./Reel

■ Soldering Conditions and Safety Precautions

Please see Data Files

■ Explanation of Part Numbers

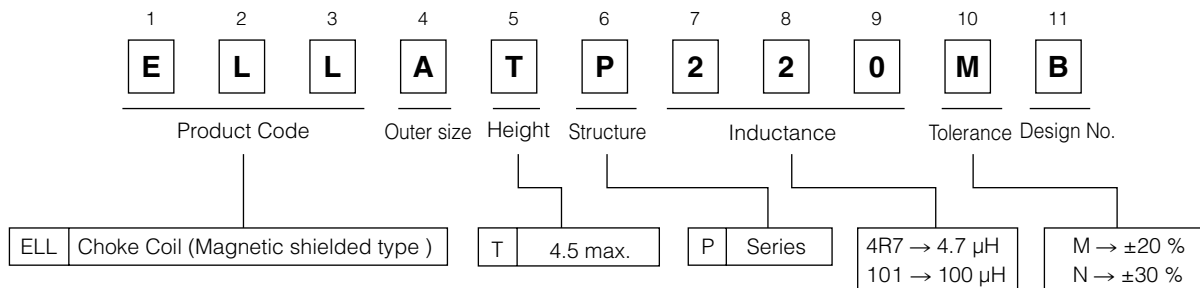

■ Dimensions in mm (not to scale)

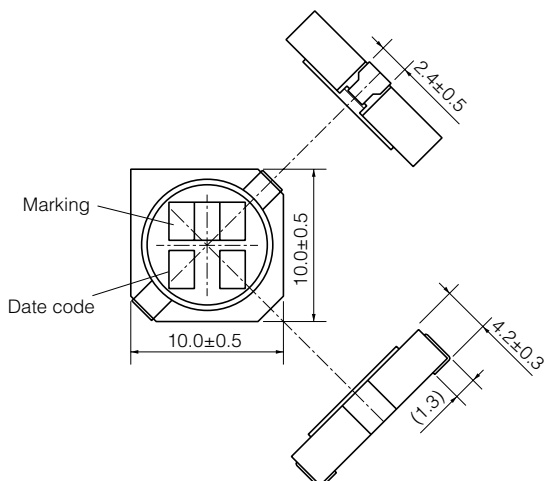

■ Recommended Land Pattern in mm (not to scale)

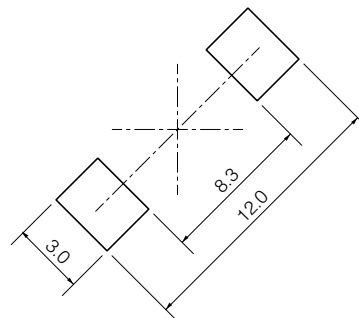

Standard Parts

Part Number	Inductance (100 kHz)		R _{DC} (at 20 °C)		Saturation Rated Current* ¹ (mA max.)	Temperature Rise Current* ² (mA max.)	Marking		
	(μH)	Tol.	(mΩ)	Tol.					
ELLATP1R0NB	1.0	±30 %	3.6	±30 %	9000	8000	1R0		
ELLATP1R5NB	1.5		4.4		8000	7000	1R5		
ELLATP2R7NB	2.7		6.4		5500	6500	2R7		
ELLATP3R3NB	3.3		7.5		5350	5500	3R3		
ELLATP4R7NB	4.7		9.1		4500	5000	4R7		
ELLATP5R1NB	5.1		12		4350	4500	5R1		
ELLATP6R8NB	6.8		15		4000	4000	6R8		
ELLATP8R2NB	8.2		18		3700	3700	8R2		
ELLATP100MB	10.0		±20 %		22	±20 %	3300	3300	100
ELLATP120MB	12.0				25		2900	2900	120
ELLATP150MB	15.0	29		2700	2700		150		
ELLATP220MB	22.0	38		2200	2500		220		
ELLATP270MB	27.0	47		1900	2200		270		
ELLATP330MB	33.0	59		1800	2000		330		
ELLATP390MB	39.0	66		1600	1800		390		
ELLATP470MB	47.0	80		1500	1700		470		
ELLATP680MB	68.0	120		1100	1400		680		
ELLATP820MB	82.0	140		1050	1300		820		
ELLATP101MB	100.0	180		1000	1200		101		
ELLATP121MB	120.0	200		900	1000		121		
ELLATP151MB	150.0	250		780	900		151		
ELLATP181MB	180.0	320		750	750		181		
ELLATP221MB	220.0	360		700	700		221		
ELLATP331MB	330.0	550		550	600		331		
ELLATP471MB	470.0	780		470	500		471		
ELLATP681MB	680.0	1150		380	450		681		
ELLATP102MB	1000.0	1700		310	370		102		

*1 Saturation Rated Current : This DC current which causes a 30 % inductance reduction from its nominal value.

*2 Temperature Rise Current : This indicates the value of current when temperature rise dt/t= 40 °C (at 20 °C).

Embossed Carrier Tape Dimensions in mm (not to scale)

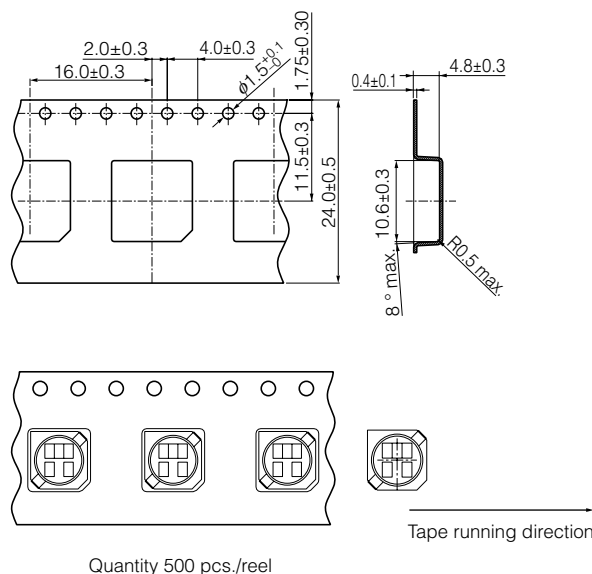

Design and specifications are each subject to change without notice. Ask factory for the current technical specifications before purchase and/or use. Should a safety concern arise regarding this product, please be sure to contact us immediately.

Power Inductors / Wire Wound type

Series: **P**
 Type: **ELLCTP**

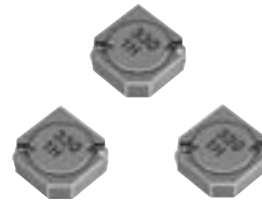

■ Features

- Magnetic shielded structure
- Low DC resistance and large current capability
- Available on tape and reel for automatic insertion
- RoHS compliant

■ Recommended Applications

- DC-DC converter circuitry for computer peripherals and amusement equipment.
- Chopper circuit decoupling chokes for DC-DC converter circuitry.

■ Standard Packing Quantity

- 500 pcs./Reel

■ Soldering Conditions and Safety Precautions

Please see Data Files

■ Explanation of Part Numbers

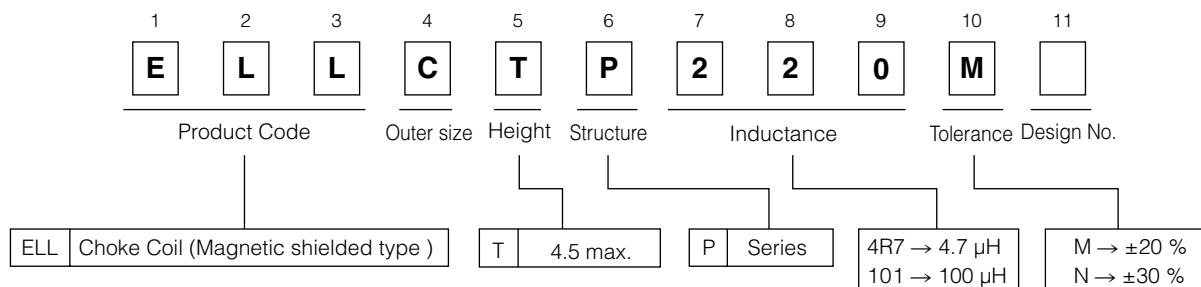

■ Dimensions in mm (not to scale)

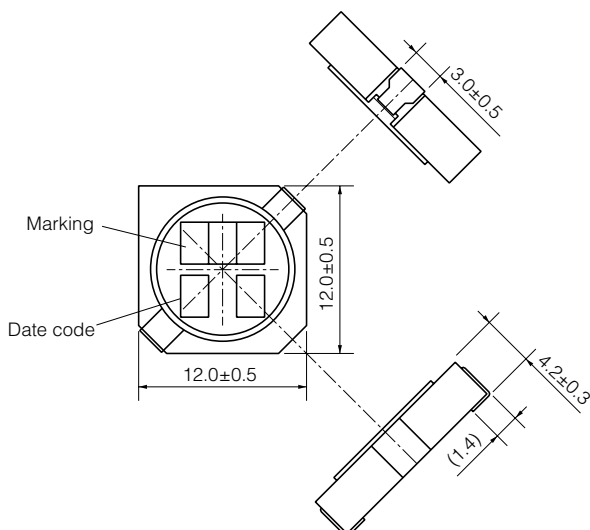

■ Recommended Land Pattern in mm (not to scale)

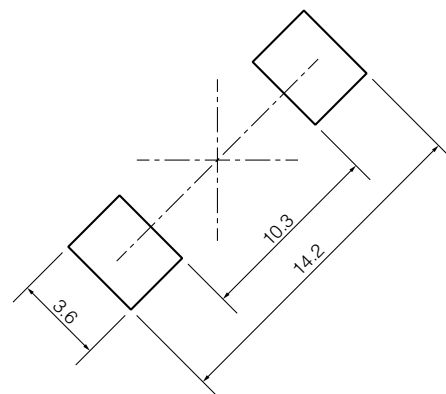

Standard Parts

Part Number	Inductance (100 kHz)		R _{DC} (at 20 °C)		Saturation Rated Current* ¹ (mA max.)	Temperature Rise Current* ² (mA max.)	Marking
	(μH)	Tol.	(mΩ)	Tol.			
ELLCTP1R2NB	1.2	±30 %	4.6	±30 %	11000	7000	1R2
ELLCTP2R0NB	2.0		5.6		9000	6500	2R0
ELLCTP3R3NB	3.3		7.0		7000	5800	3R3
ELLCTP4R3NB	4.3		8.5		6000	5000	4R3
ELLCTP5R6NB	5.6		10.0		5500	4500	5R6
ELLCTP6R8NB	6.8		12.5		5000	4000	6R8
ELLCTP9R1NB	9.1		15.0		4400	3800	9R1
ELLCTP150MB	15.0		±20 %		27.0	±20 %	3100
ELLCTP220MB	22.0	34.0		2600	2600		220
ELLCTP330MB	33.0	52.0		2200	2100		330
ELLCTP470MB	47.0	72.0		1900	1800		470
ELLCTP680MB	68.0	97.0		1500	1500		680
ELLCTP101MB	100.0	150.0		1200	1200		101
ELLCTP151MB	150.0	220.0		1050	1000		151
ELLCTP221MB	220.0	310.0		900	850		221
ELLCTP331MB	330.0	500.0		750	700		331
ELLCTP471MB	470.0	670.0		600	550		471
ELLCTP681MB	680.0	1070.0		550	450		681
ELLCTP102MB	1000.0	1470.0		400	400		102

*1 Saturation Rated Current: This DC current which causes a 30% inductance reduction from its nominal value.

*2 Temperature Rise Current : This indicates the value of current when temperature rise dt/t= 40 °C (at 20 °C).

Embossed Carrier Tape Dimensions in mm (not to scale)

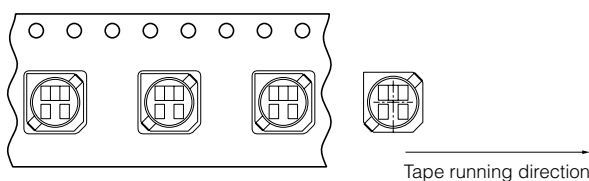
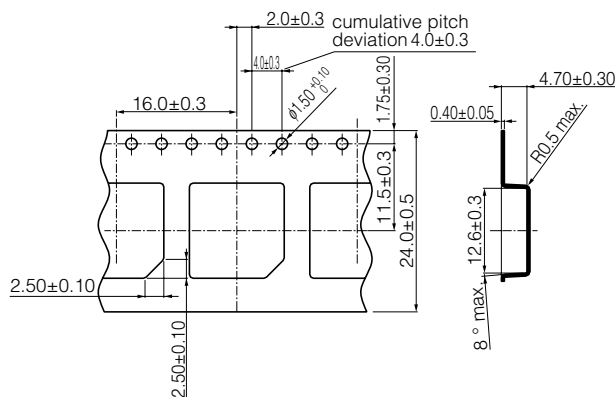

Quantity 500 pcs./reel

Power Inductors / Wire Wound type

Series: **N**
 Type: **ELCSFN-A**



■ Features

- Low DC resistance and large current capability
- RoHS compliant

■ Recommended Applications

- DC-DC converter circuitry for computer peripherals and cellular phones.

■ Standard Packing Quantity

- 2000 pcs./Reel

■ Soldering Conditions and Safety Precautions

Please see Data Files

■ Explanation of Part Numbers

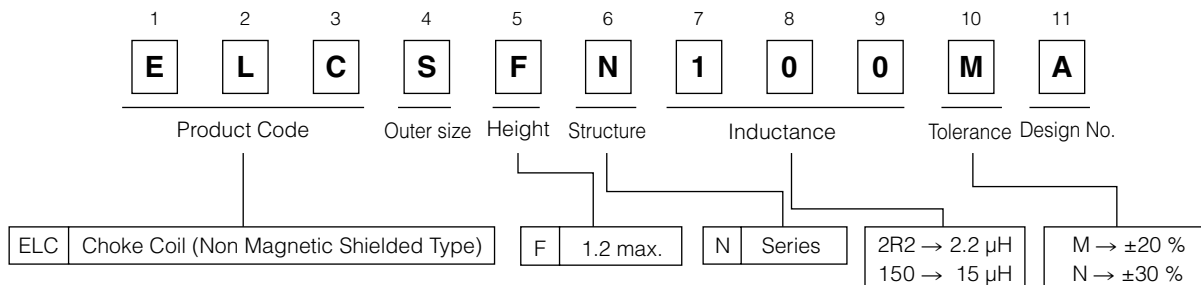

■ Dimensions in mm (not to scale)

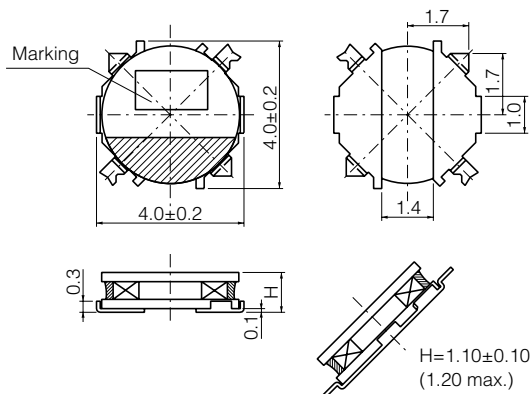

■ Recommended land patterns in mm (not to scale)

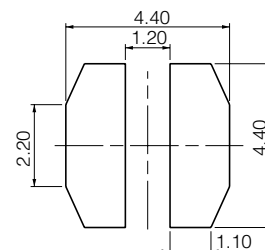

Standard Parts

Part Number	Inductance (100 kHz)		R _{DC} (at 20 °C)		Saturation Rated Current*1 (mA max.)	Temperature Rise Current*2 (mA max.)	Marking
	(μH)	Tol.	(mΩ)	Tol.			
ELCSFN1R0NA	1.0	±30%	60	±20%	2750	1700	A
ELCSFN2R2NA	2.2		95		2000	1300	D
ELCSFN3R3NA	3.3		150		1500	1100	E
ELCSFN4R7NA	4.7		190		1350	950	H
ELCSFN6R8NA	6.8		250		1100	850	K
ELCSFN100MA	10.0	±20%	400		950	650	M
ELCSFN220MA	22.0		920	650	450	R	

*1 Saturation Rated Current : This DC current which causes a 30 % inductance reduction from its nominal value.

*2 Temperature Rise Current : This indicates the value of current when temperature rise dt/t= 40 °C (at 20 °C).

Embossed Carrier Tape Dimensions in mm (not to scale)

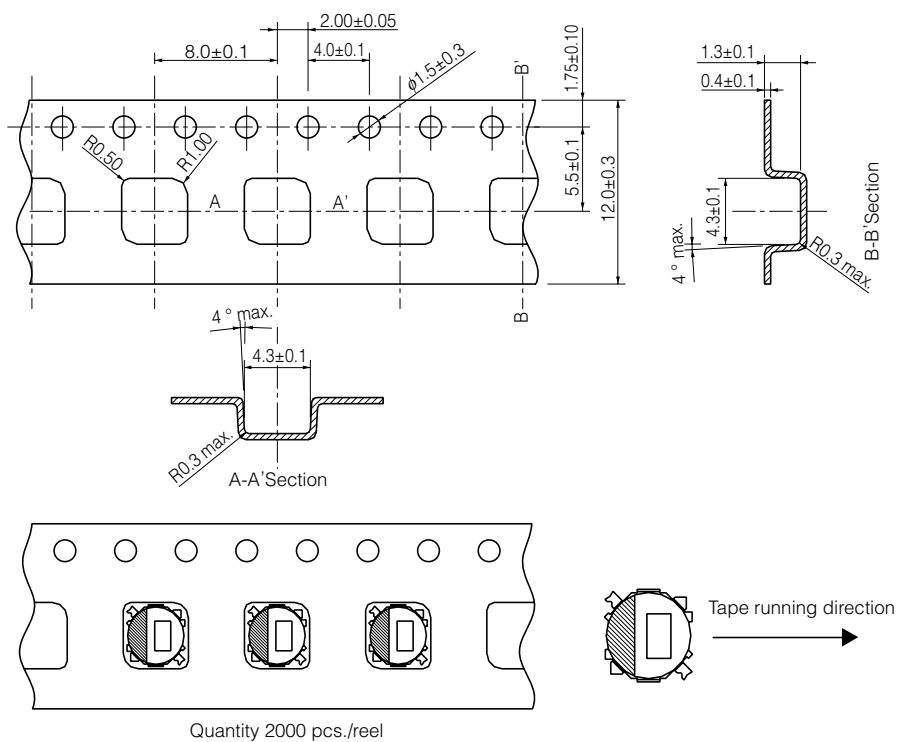

Soldering Conditions

■ Reflow soldering conditions

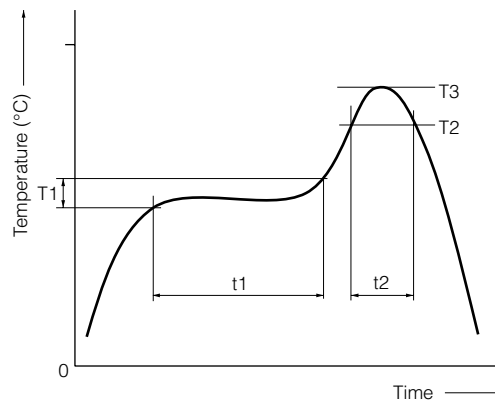

● Pb free solder recommended temperature profile

Products Item	Preheat		Soldering		Peak Temperature		Time of Reflow
	T1 [°C]	t1 [s]	T2 [°C]	t2 [s]	T3	T3 Limit	
Power Inductors / Wire Wound type	150 to 170	60 to 120	230 °C	30 max.	245 °C, 10 s	260 °C, 10 s	2 times max.

⚠ Safety Precautions (Common precautions for Power Inductors / Wire Wound type)

- When using our products, no matter what sort of equipment they might be used for, be sure to make a written agreement on the specifications with us in advance. The design and specifications in this catalog are subject to change without prior notice.
- Do not use the products beyond the specifications described in this catalog.
- This catalog explains the quality and performance of the products as individual components. Before use, check and evaluate their operations when installed in your products.
- Install the following systems for a failsafe design to ensure safety if these products are to be used in equipment where a defect in these products may cause the loss of human life or other significant damage, such as damage to vehicles (automobile, train, vessel), traffic lights, medical equipment, aerospace equipment, electric heating appliances, combustion/gas equipment, rotating equipment, and disaster/crime prevention equipment.
- * Systems equipped with a protection circuit and a protection device
- * Systems equipped with a redundant circuit or other system to prevent an unsafe status in the event of a single fault

⚠ Precautions for use

1. Operation range and environments

- ① These products are designed and manufactured for general and standard use in general electronic equipment (e.g. AV equipment, home electric appliances, office equipment, information and communication equipment)
- ② These products are not intended for use in the following special conditions. Before using the products, carefully check the effects on their quality and performance, and determine whether or not they can be used.
 - In liquid, such as water, oil, chemicals, or organic solvent
 - In direct sunlight, outdoors, or in dust
 - In salty air or air with a high concentration of corrosive gas, such as Cl₂, H₂S, NH₃, SO₂, or NO₂
 - In an environment where these products cause dew condensation

2. Handling

- ① Do not bring magnets or magnetized materials close to the product. The influence of their magnetic field can change the inductance value.
- ② Do not apply strong mechanical shocks by either dropping or collision with other parts.
Excessive shock can damage the part.

3. Washing of board

Kindly consult the Technical department before washing of the PWB with any cleansing agent, and provide the washing condition.

4. Resoldering with a soldering iron

The temperature of the tip of the soldering iron should be 360 °C or less, 4 seconds.
And resoldering with a soldering iron should be limited to 1 time, and after that should be cooling these.

5. Mounting side

External force must be less than 5.0 [N] : while mounting.

6. Storage conditions

Normal temperature (–5 to 35 °C), normal humidity (85 % RH max.), shall not be exposed to direct sunlight and harmful gases and care should be taken so as not to cause dew.

<Package markings>

Package markings include the product number, quantity, and country of origin.
In principle, the country of origin should be indicated in English.

Power Choke Coil for Automotive application

Series: **PCC-D1413H (DUST)**



Realize high heat resistance, low loss and high reliability with dust core (DUST)

Industrial Property : patents 5 (Pending)

■ Features

- High heat resistance : Operation up to 150 °C
- SMD and small package : L×W×T=14.7×13.2×13.1 mm
- High-reliability : High vibration resistance due to newly developed integral construction and severe reliability condition of automotive application is covered
- High bias current : Excellent inductance stability by using ferrous alloy magnetic material
- High Vibration proof : 5 Hz to 2 kHz/30 G
- High efficiency : Achieve by Low loss Dust core and Edgewise coil with rectangular wire
- AEC-Q200 qualified
- RoHS compliant

■ Recommended Applications

- Driver circuits of fuel injection systems in automotive, driver circuits of diesel common rail injection, step-up power supplies for motor driver-circuits

■ Standard Packing Quantity

- 600 pcs./10 Tray

■ Explanation of Part Numbers

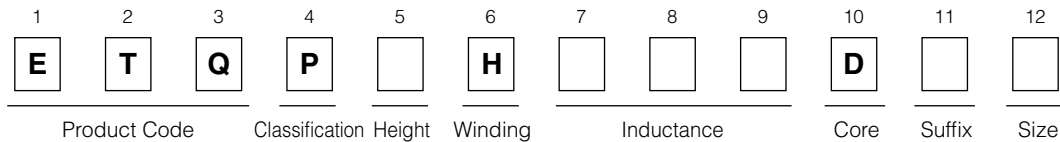

■ Temperature rating

Operating temperature range		Tc : -40 °C to +150 °C(Including self-temperature rise)
Storage condition	After PWB mounting	
	Before PWB mounting	Ta : -5 °C to +35 °C 85%RH max.

■ Standard Parts

Part No.	Inductance *1		DCR	ACR	Rated Current *3
	L0 at 0A (μH)	L1 at 10A (μH)	at 20 °C (mΩ)	at 20 kHz (mΩ)	ΔT=40K (A)
ETQPDH240DTV	36.0±30%	(24.0) *2	25.8 typ.	50.0 typ.	6.9

(*1) Measured at 100 kHz.

(*2) Reference Only.

(*3) DC current which causes temperature rise of 40 K. Parts are soldered by reflow on four-layer PWB (1.6 mm FR4) and measured at room temperature.

* Within a suitable application, the part's temperature depends on circuit design and certain heat dissipation conditions. This should be double checked in a worst case operation mode.

In normal case, the max. standard operating temperature of +150 °C should not be exceeded.

For higher operating temperature conditions, please contact Panasonic representative in your area.

■ Performance Characteristics (Reference)

● Inductance vs DC Current

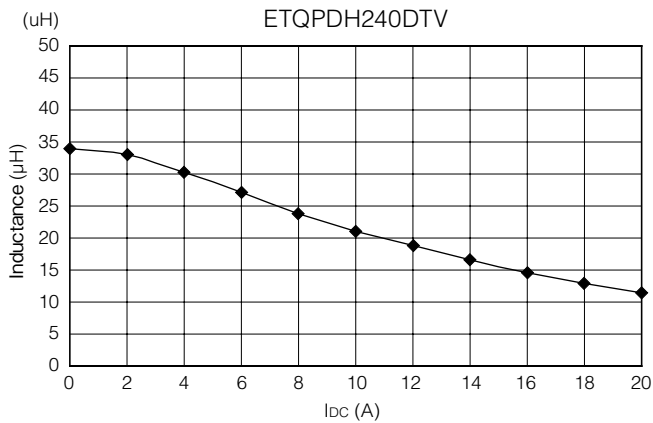

● Case Temperature vs DC Current

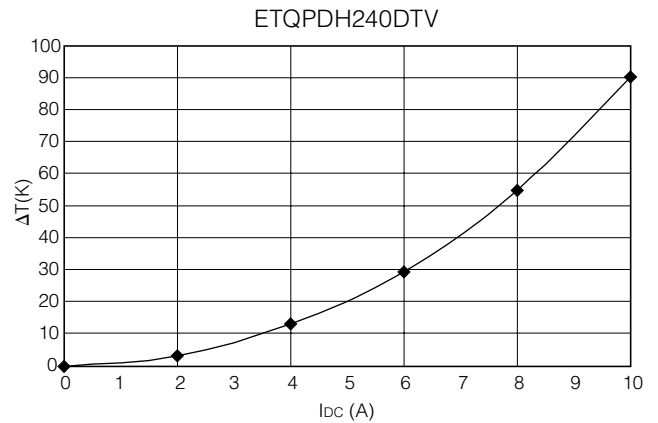

■ Dimensions in mm (not to scale)

Dimensional tolerance unless noted : ± 0.5

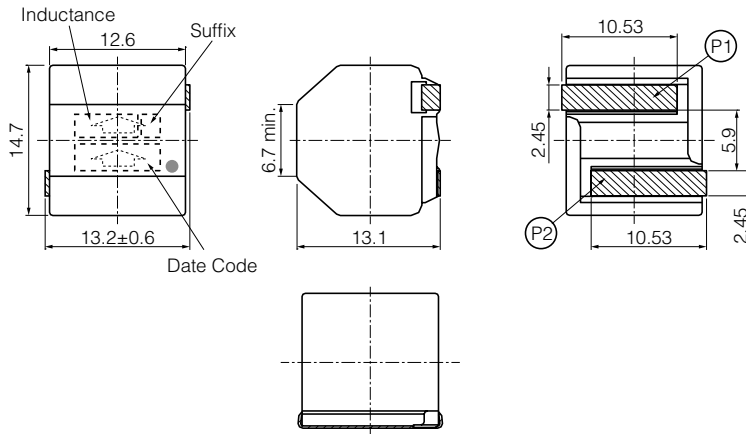

■ Connection

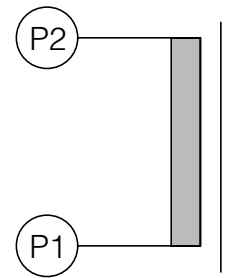

* None polar character

■ Recommended Land Pattern in mm (not to scale)

Dimensional tolerance unless noted : ± 0.5

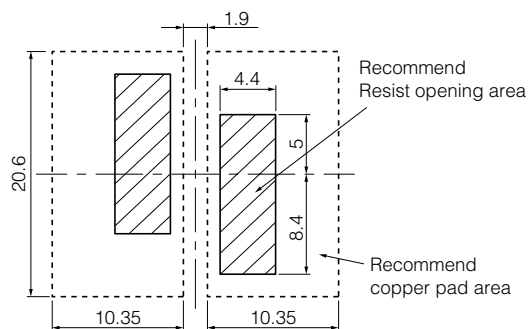

* Due to bigger part, Thermal Capacity is large and may occur PWB temperature differences during reflow process. Recommended land pattern (Heat absorb) should be designed with reflow mountability.

■ Soldering Conditions and Safety Precautions (Common precautions for Power Choke Coils for high reliability use)

Please see Data Files

■ Packaging Methods (Tray)

- Blister Tray (mm) 60 pcs.

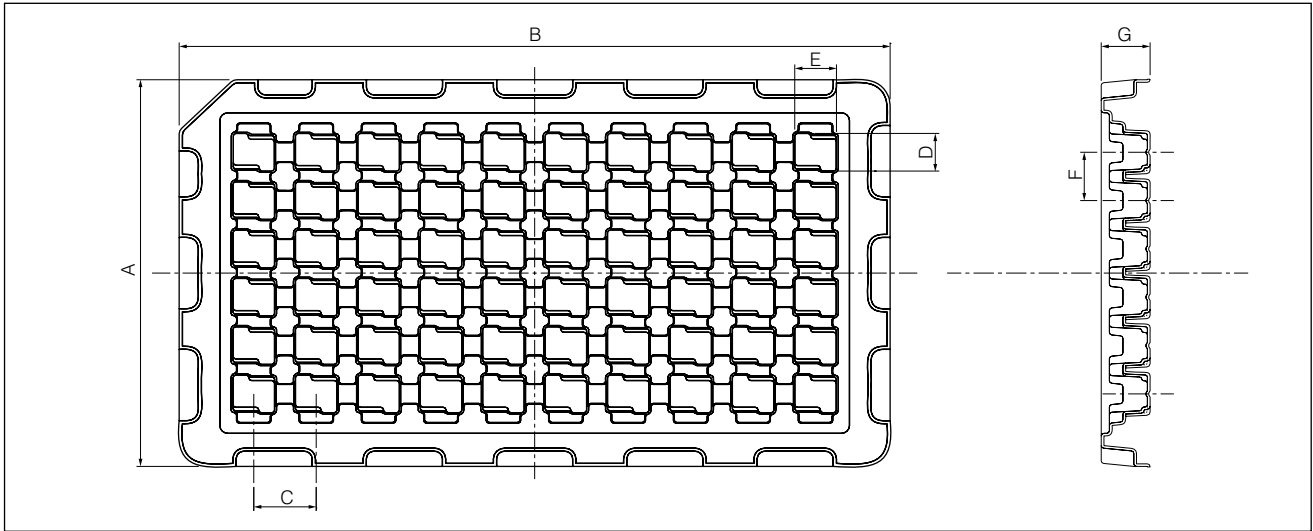

Blister Tray Dimension

Part No.	A	B	C	D	E	F	G
ETQPDH240DTV	152	262	23	14.8	15.1	19	18

■ Component Placement (Tray)

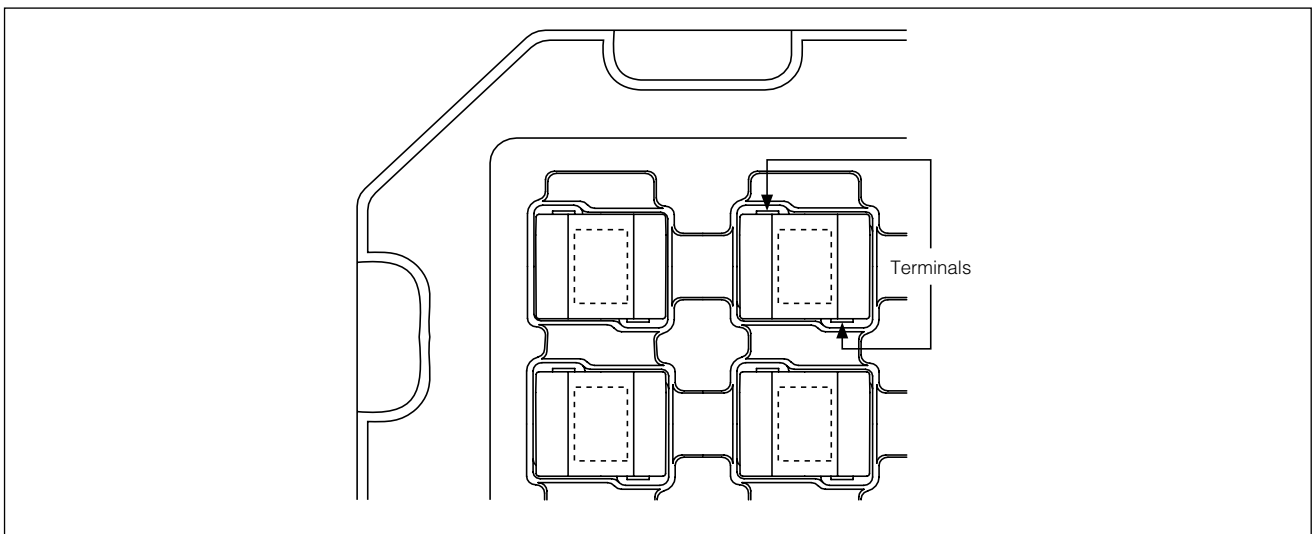

■ Standard Packing Quantity/Tray

Part No.	Quantity
ETQPDH240DTV	600 pcs. /10 Tray (60 pcs. /1 Tray)

Power Choke Coil for Automotive application

Series: **PCC-M0530M (MC)** **PCC-M0540M (MC)**
PCC-M0630M (MC) **PCC-M0645M (MC)**
PCC-M0754M (MC)
PCC-M0854M (MC) **PCC-M0850M (MC)**
PCC-M1054M (MC) **PCC-M1050M (MC)**
PCC-M1050ML (MC) **PCC-M1060ML (MC)**

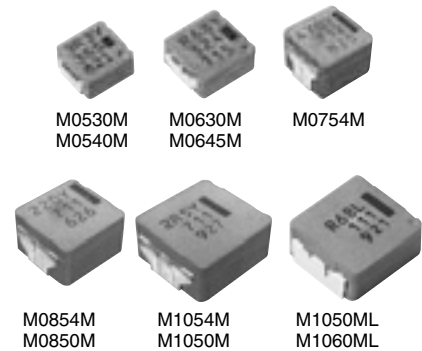

Realize high heat resistance and high reliability with metal composite core(MC)

Industrial Property : patents 21 (Registered 2/Pending 19)

■ Features

- High heat resistance : Operation up to 150 °C
- High-reliability : High vibration resistance due to newly developed integral construction and severe reliability condition of automotive application is covered
- High bias current : Excellent inductance stability by using ferrous alloy magnetic material(Fig.1)
- Temp. stability : Excellent inductance stability in wide temp. range (Fig.1)
- Low buzz noise : New metal composite core technology
- High efficiency : Low R_{DC} of winding and low eddy-current loss of the core
- AEC-Q200 qualified
- RoHS compliant

● Fig.1 Inductance v.s. DC current, Temp.

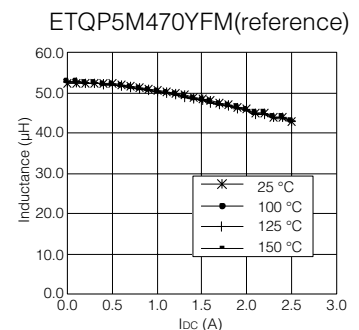

■ Recommended Applications

- Noise filter for various drive circuitry requiring high temp. operation and peak current handling capability
- DC-DC converters

■ Standard Packing Quantity (Minimum Quantity/Packing Unit)

- 1000 pcs./box (2 reel) : PCC-M0645M, M0754M, M0854M, M0850M, M1054M, M1050M, M1050ML, M1060ML
- 2000 pcs./box (2 reel) : PCC-M0530M, M0540M, M0630M

■ Explanation of Part Numbers

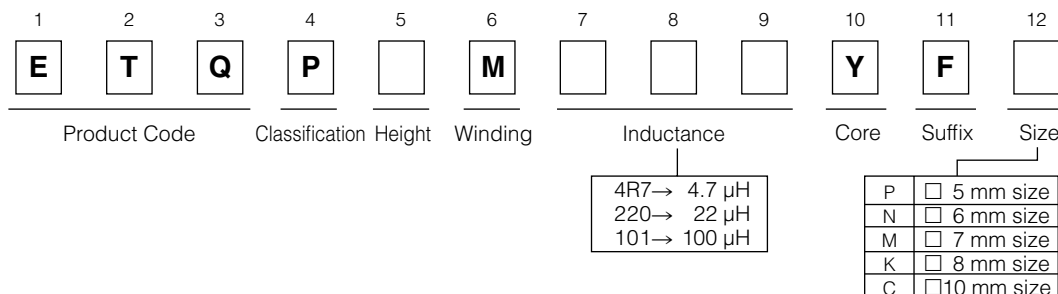

■ Temperature rating

Operating temperature range		Tc : -40 °C to +150 °C(Including self-temperature rise)
Storage condition	After PWB mounting	
	Before PWB mounting	Ta : -5 °C to +35 °C 85%RH max.

Design and specifications are each subject to change without notice. Ask factory for the current technical specifications before purchase and/or use. Should a safety concern arise regarding this product, please be sure to contact us immediately.

1. Series PCC-M0530M/PCC-M0540M (ETQP3M□□□YFP/ETQP4M□□□YFP)

■ Standard Parts

Series	Part No.	Inductance *1		DCR (at 20 °C) (mΩ)		Rated Current (Typ. : A)		
		L0 (μH)	Tolerance (%)	Typ. (max.)	Tolerance (%)	ΔT=40K		ΔL=-30%
						(*2)	(*3)	(*4)
PCC-M0530M [5.5×5.0×3.0(mm)]	ETQP3M3R3YFP	3.3	±20	31.3 (34.4)	±10	4.1	5.0	8.6
PCC-M0540M [5.5×5.0×4.0(mm)]	ETQP4M4R7YFP	4.7		36.0 (39.6)		4.0	4.8	7.7
	ETQP4M220YFP	22		163 (179)		1.9	2.3	3.1

(*1) Measured at 100 kHz.

(*2) DC current which causes temperature rise of 40 K. Parts are soldered by reflow on four-layer PWB (1.6 mm FR4) and measured at room temperature. See also (*5)

(*3) DC current which causes temperature rise of 40 K. Parts are soldered by reflow on multilayer PWB with high heat dissipation performance. Note: Heat radiation constant are approx. 52 K/W measured on 5.5×5.0×3.0 mm case size and approx. 48 K/W measured on 5.5×5.0×4.0 mm case size. See also (*5)

(*4) Saturation rated current : DC current which causes L(0) drop -30 %.

(*5) Within a suitable application, the part's temperature depends on circuit design and certain heat dissipation conditions. This should be double checked in a worst case operation mode.

In normal case, the max.standard operating temperature of +150 °C should not be exceeded.

For higher operating temperature conditions, please contact Panasonic representative in your area.

■ Performance Characteristics (Reference)

● Inductance vs DC Current

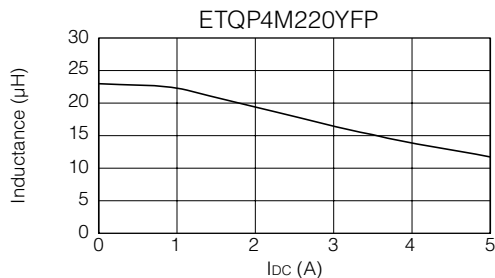
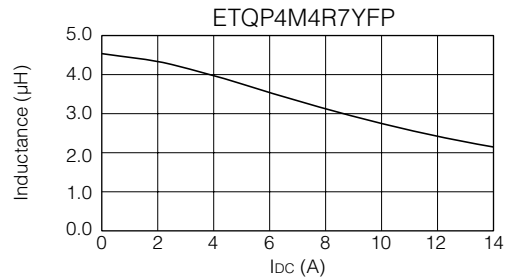
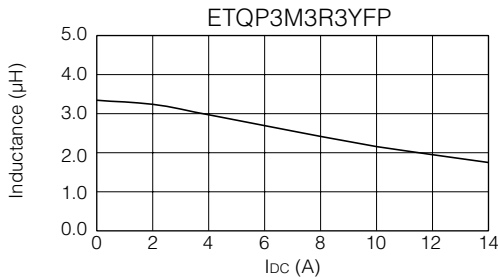

● Case Temperature vs DC Current

PWB condition A : Four-layer PWB (1.6 mm FR4), See also (*2)

PWB condition B : Multilayer PWB with high heat dissipation performance. See also (*3)

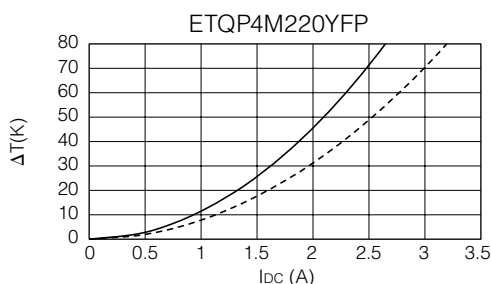
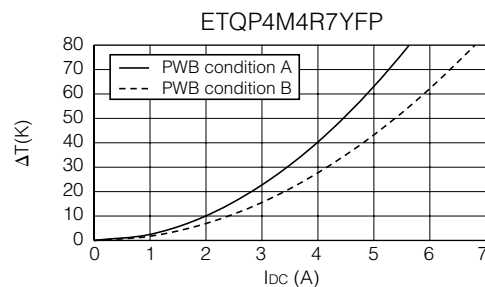
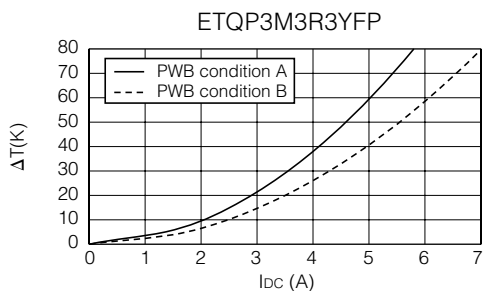

2. Series PCC-M0630M/PCC-M0645M (ETQP3M□□□YFN/ETQP4M□□□YFN)

Standard Parts

Series	Part No.	Inductance *1		DCR (at 20 °C) (mΩ)		Rated Current (Typ. : A)		
		L0 (μH)	Tolerance (%)	Typ. (max.)	Tolerance (%)	ΔT=40K		ΔL=-30%
						(*2)	(*3)	(*4)
PCC-M0630M [6.5×6.0×3.0(mm)]	ETQP3MR68YFN	0.68	±20	6.3 (6.9)	±10	9.8	12.0	24.0
	ETQP3M1R0YFN	1.0		7.9 (8.7)		8.8	10.7	20.0
PCC-M0645M [6.5×6.0×4.5(mm)]	ETQP4M100YFN	10		54.2 (59.6)		3.3	4.5	8.3

(*1) Measured at 100 kHz.

(*2) DC current which causes temperature rise of 40 K. Parts are soldered by reflow on four-layer PWB (1.6 mm FR4) and measured at room temperature. See also (*5)

(*3) DC current which causes temperature rise of 40 K. Parts are soldered by reflow on multilayer PWB with high heat dissipation performance. Note: Heat radiation constant are approx. 44 K/W measured on 6.5×6.0×3.0 mm case size and approx. 37 K/W measured on 6.5×6.0×4.5 mm case size. See also (*5)

(*4) Saturation rated current : DC current which causes L(0) drop -30 %.

(*5) Within a suitable application, the part's temperature depends on circuit design and certain heat dissipation conditions. This should be double checked in a worst case operation mode.

In normal case, the max.standard operating temperature of +150 °C should not be exceeded.

For higher operating temperature conditions, please contact Panasonic representative in your area.

Performance Characteristics (Reference)

Inductance vs DC Current

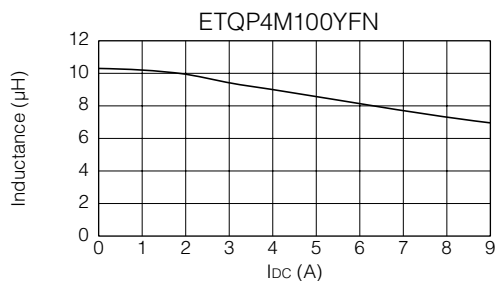
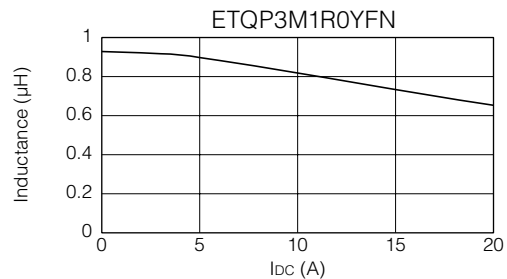
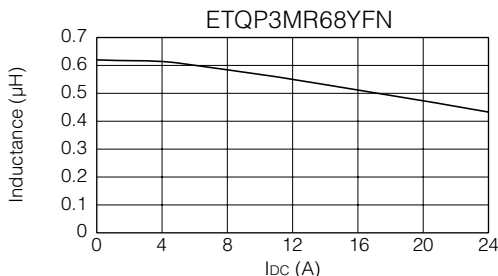

Case Temperature vs DC Current

PWB condition A : Four-layer PWB (1.6 mm FR4), See also (*2)

PWB condition B : Multilayer PWB with high heat dissipation performance. See also (*3)

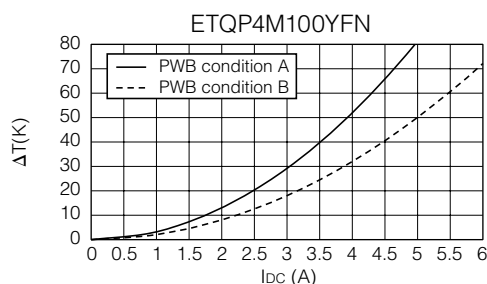
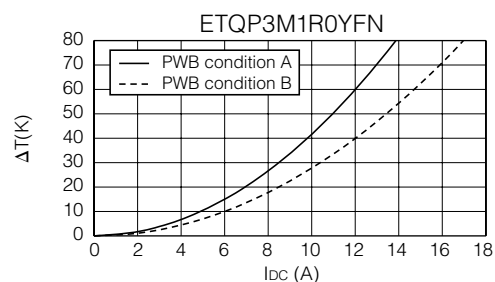
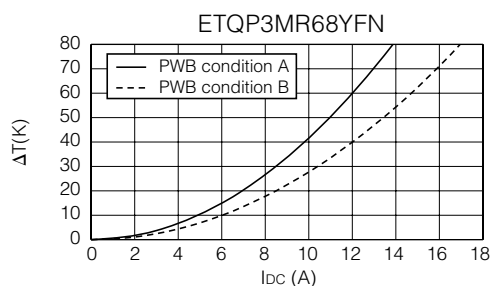

3. Series PCC-M0754M (ETQP5M□□□YFM)

■ Standard Parts

Series	Part No.	Inductance *1		DCR (at 20 °C) (mΩ)		Rated Current (Typ. : A)		
		L0 (μH)	Tolerance (%)	Typ. (max.)	Tolerance (%)	ΔT=40K		ΔL=-30%
						(*2)	(*3)	(*4)
PCC-M0754M [7.5×7.0×5.4(mm)]	ETQP5M4R7YFM	4.7	±20	20(23)	±10	6.3	8.0	13.1
	ETQP5M220YFM	22		92(102)		3.0	3.7	5.8
	ETQP5M330YFM	34		120(132)		2.6	3.3	4.8
	ETQP5M470YFM	48		156(172)		2.3	2.9	4.1

(*1) Measured at 100 kHz.

(*2) DC current which causes temperature rise of 40 K. Parts are soldered by reflow on four-layer PWB (1.6 mm FR4) and measured at room temperature. See also (*5)

(*3) DC current which causes temperature rise of 40 K. Parts are soldered by reflow on multilayer PWB with high heat dissipation performance. Note: Heat radiation constant is approx. 31 K/W measured on 7.5×7.0×5.4 mm case size. See also (*5)

(*4) Saturation rated current : DC current which causes L(0) drop -30 %.

(*5) Within a suitable application, the part's temperature depends on circuit design and certain heat dissipation conditions. This should be double checked in a worst case operation mode.

In normal case, the max. standard operating temperature of +150 °C should not be exceeded.

For higher operating temperature conditions, please contact Panasonic representative in your area.

■ Performance Characteristics (Reference)

● Inductance vs DC Current

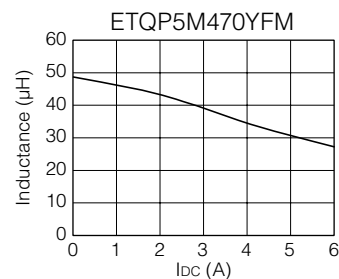
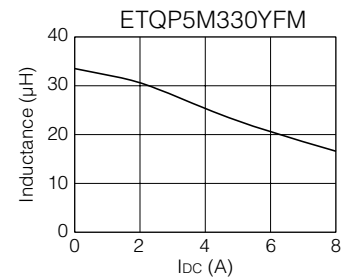
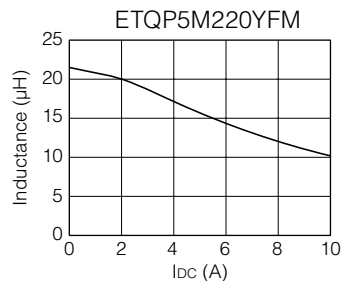
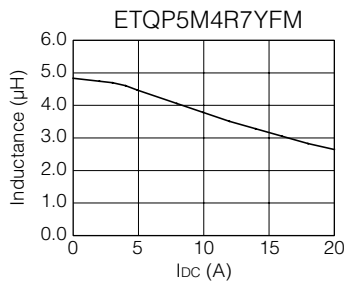

● Case Temperature vs DC Current

PWB condition A : Four-layer PWB (1.6 mm FR4), See also (*2)

PWB condition B : Multilayer PWB with high heat dissipation performance. See also (*3)

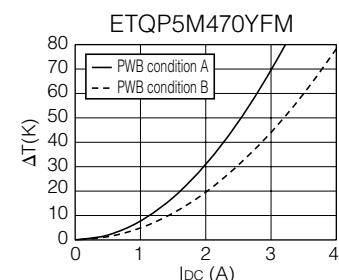
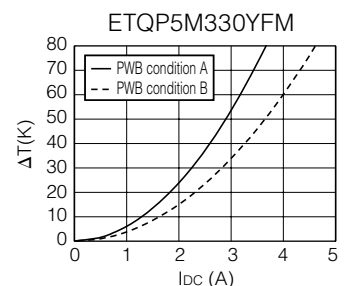
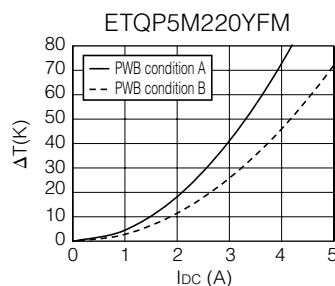
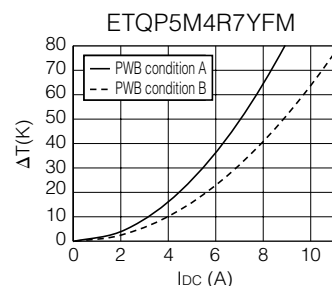

4. Series PCC-M0854M/PCC-M0850M (ETQP5M□□□YFK/ETQP5M□□□YGK)

Standard Parts

Series	Part No.	Inductance *1		DCR (at 20 °C) (mΩ)		Rated Current (Typ. : A)		
		L0 (μH)	Tolerance (%)	Typ. (max.)	Tolerance (%)	ΔT=40K		ΔL=-30%
						(*2)	(*3)	(*4)
PCC-M0854M [8.5×8.0×5.4(mm)]	ETQP5M2R5YFK	2.5	±20	7.6(8.4)	±10	11.9	14.0	20.1
	ETQP5M100YFK	10		33(37)		5.7	6.7	13.0
	ETQP5M220YFK	22		63(70)		4.1	4.8	6.9
	ETQP5M470YFK	48		125(138)		2.9	3.4	5.4
PCC-M0850M [8.5×8.0×5.0(mm)]	ETQP5M101YGK	100	±20	302(333)	±10	1.7	2.1	3.0

(*1) Measured at 100 kHz.

(*2) DC current which causes temperature rise of 40 K. Parts are soldered by reflow on four-layer PWB (1.6 mm FR4) and measured at room temperature. See also (*5)

(*3) DC current which causes temperature rise of 40 K. Parts are soldered by reflow on multilayer PWB with high heat dissipation performance. Note: Heat radiation constant are approx. 27 K/W measured on 8.5×8.0×5.4 mm case size and approx. 29 K/W measured on 8.5×8.0×5.0 mm case size. See also (*5)

(*4) Saturation rated current : DC current which causes L(0) drop -30 %.

(*5) Within a suitable application, the part's temperature depends on circuit design and certain heat dissipation conditions. This should be double checked in a worst case operation mode.

In normal case, the max.standard operating temperature of + 150 °C should not be exceeded.

For higher operating temperature conditions, please contact Panasonic representative in your area.

Performance Characteristics (Reference)

Inductance vs DC Current

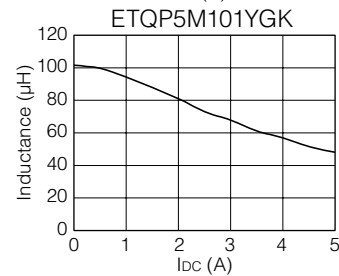
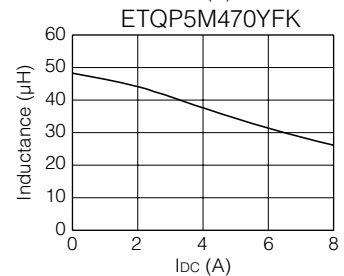
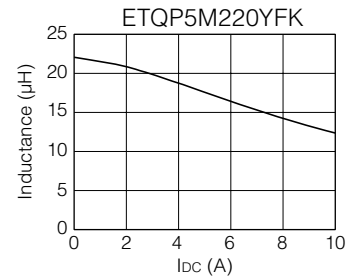
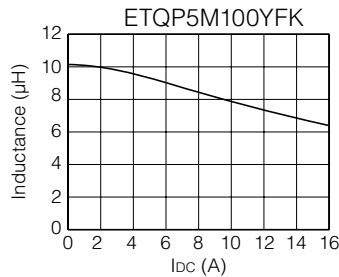
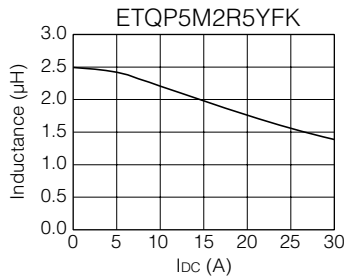

Case Temperature vs DC Current

PWB condition A : Four-layer PWB (1.6 mm FR4), See also (*2)

PWB condition B : Multilayer PWB with high heat dissipation performance. See also (*3)

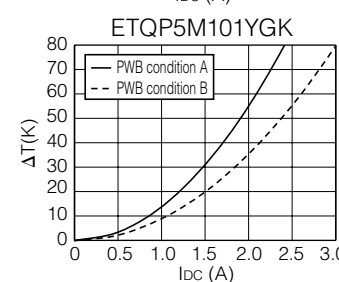
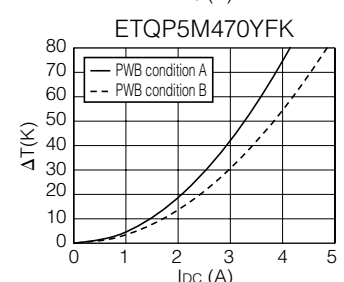
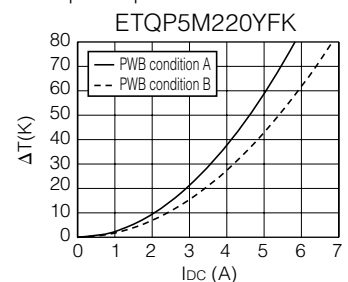
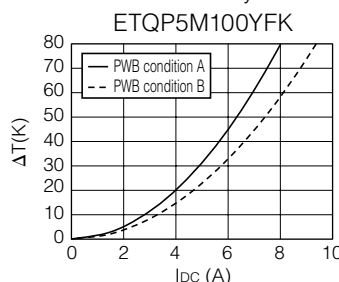
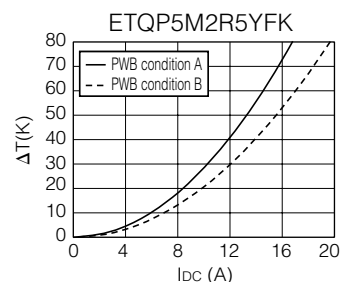

5. Series PCC-M1054M/PCC-M1050M (ETQP5M□□□YFC/ETQP5M□□□YGC)

Standard Parts

Series	Part No.	Inductance *1		DCR (at 20 °C) (mΩ)		Rated Current (Typ. : A)		
		L0 (μH)	Tolerance (%)	Typ. (max.)	Tolerance (%)	ΔT=40K		ΔL=-30%
						(*2)	(*3)	(*4)
PCC-M1054M [10.7×10.0×5.4(mm)]	ETQP5M2R5YFC	2.5	±20	5.3(5.9)	±10	15.1	18.1	27.2
	ETQP5M3R3YFC	3.3		7.1(7.9)		13.1	15.7	22.7
	ETQP5M4R7YFC	4.7		10.2(11.3)		10.9	13.1	20.0
	ETQP5M100YFC	10		23.8(26.2)		7.1	8.5	10.7
	ETQP5M220YFC	22		45(50)		5.2	6.2	6.7
PCC-M1050M [10.7×10.0×5.0(mm)]	ETQP5M101YGC	97	±20	208(229)	±10	2.2	2.7	3.0

(*1) Measured at 100 kHz.

(*2) DC current which causes temperature rise of 40 K. Parts are soldered by reflow on four-layer PWB (1.6 mm FR4) and measured at room temperature. See also (*5)

(*3) DC current which causes temperature rise of 40 K. Parts are soldered by reflow on multilayer PWB with high heat dissipation performance. Note: Heat radiation constant are approx. 23 K/W measured on 10.7×10.0×5.4 mm case size and approx. 26 K/W measured on 10.7×10.0×5.0 mm case size. See also (*5)

(*4) Saturation rated current : Dc current which causes L(0) drop -30%.

(*5) Within a suitable application, the part's temperature depends on circuit design and certain heat dissipation conditions. This should be double checked in a worst case operation mode.

In normal case, the max. standard operating temperature of +150 °C should not be exceeded.

For higher operating temperature conditions, please contact Panasonic representative in your area.

Performance Characteristics (Reference)

Inductance vs DC Current

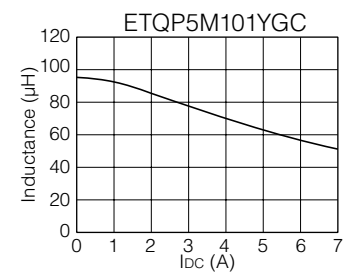
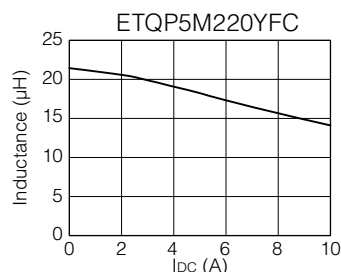
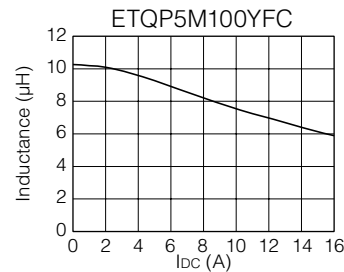
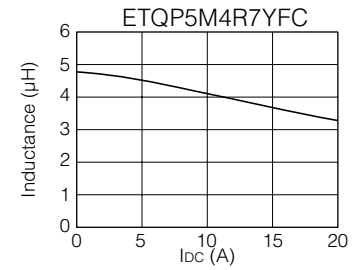
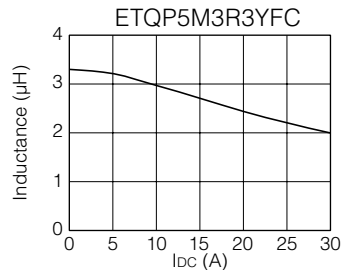
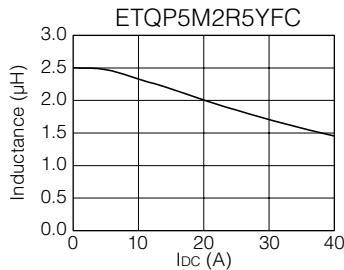

Case Temperature vs DC Current

PWB condition A : Four-layer PWB (1.6 mm FR4), See also (*2)

PWB condition B : Multilayer PWB with high heat dissipation performance. See also (*3)

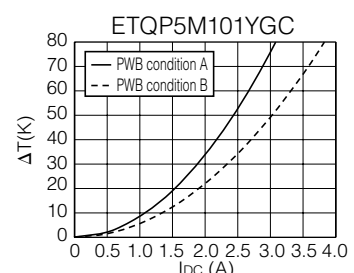
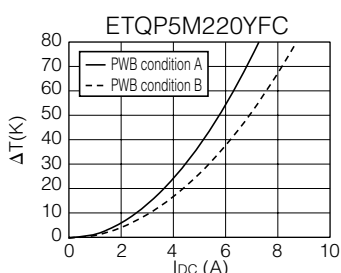
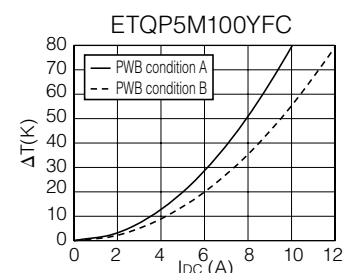
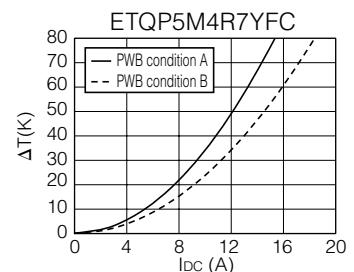
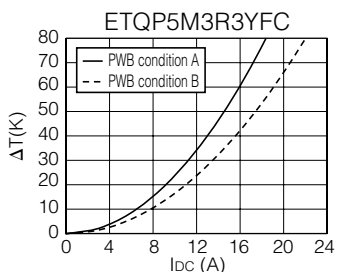
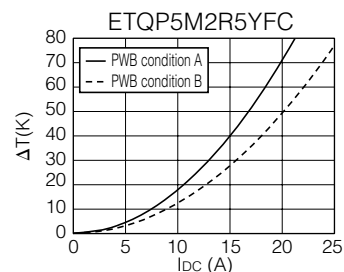

6. Series PCC-M1050ML/PCC-M1060ML (ETQP5M□□□YLC/ETQP6M□□□YLC)

■ Standard Parts

Series	Part No.	Inductance *1		DCR (at 20 °C) (mΩ)		Rated Current (Typ. : A)		
		L0 (μH)	Tolerance (%)	Typ. (max.)	Tolerance (%)	ΔT=40K		ΔL=-30%
						(*2)	(*3)	(*4)
PCC-M1050ML [10.9×10.0×5.0(mm)]	ETQP5MR68YLC	0.68	±20	1.75 (1.93)	±10	26.3	31.5	42.0
PCC-M1060ML [10.9×10.0×6.0(mm)]	ETQP6M2R5YLC	2.5	±20	4.5 (5.0)	±10	16.3	19.6	27.0

(*1) Measured at 100 kHz.

(*2) DC current which causes temperature rise of 40 K. Parts are soldered by reflow on four-layer PWB (1.6 mm FR4) and measured at room temperature. See also (*5)

(*3) DC current which causes temperature rise of 40 K. Parts are soldered by reflow on multilayer PWB with high heat dissipation performance. Note: Heat radiation constant are approx. 23 K/W measured on 10.9×10.0×5.0 mm case size and approx. 23 K/W measured on 10.9×10.0×6.0 mm case size. See also (*5)

(*4) Saturation rated current : Dc current which causes L(0) drop -30 %.

(*5) Within a suitable application, the part's temperature depends on circuit design and certain heat dissipation conditions. This should be double checked in a worst case operation mode.

In normal case, the max.standard operating temperature of +150 °C should not be exceeded.

For higher operating temperature conditions, please contact Panasonic representative in your area.

■ Performance Characteristics (Reference)

● Inductance vs DC Current

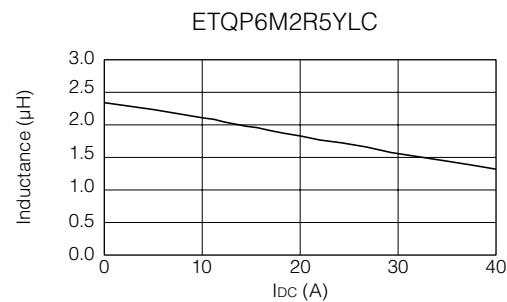
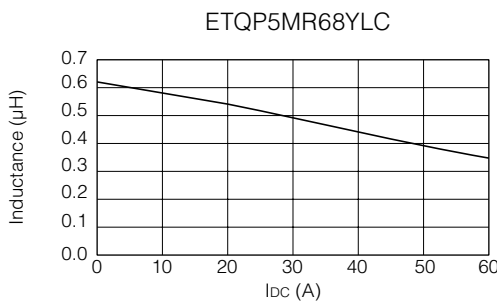

● Case Temperature vs DC Current

PWB condition A : Four-layer PWB (1.6 mm FR4), See also (*2)

PWB condition B : Multilayer PWB with high heat dissipation performance. See also (*3)

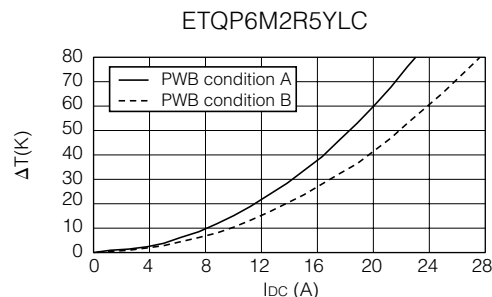
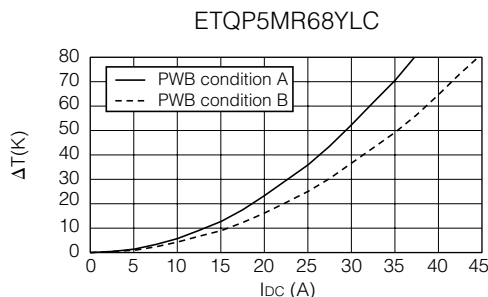

■ Dimensions in mm (not to scale)
Dimensional tolerance unless noted : ± 0.5

Series PCC-M0530M
Series PCC-M0540M
(ETQP3M□□□YFP/ETQP4M□□□YFP)

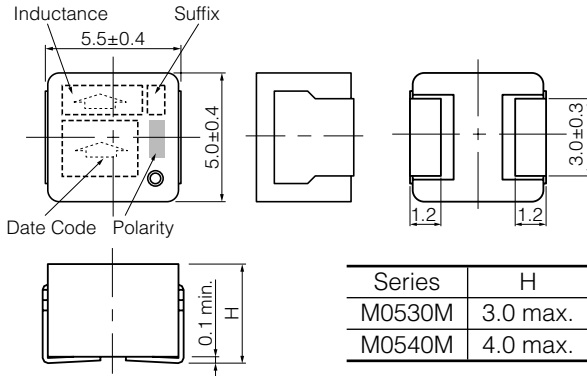

Series PCC-M0630M
Series PCC-M0645M
(ETQP3M□□□YFN/ETQP4M□□□YFN)

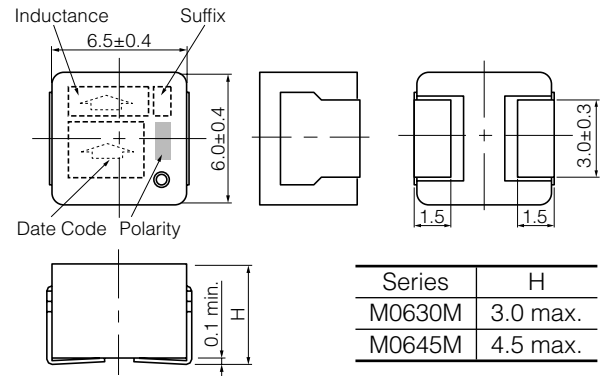

Series PCC-M0754M
(ETQP5M□□□YFM)

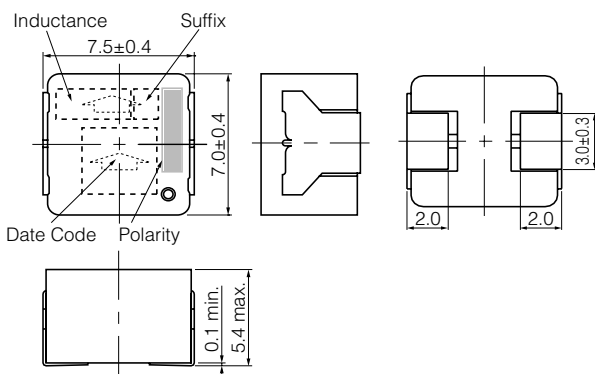

Series PCC-M0854M
Series PCC-M0850M
(ETQP5M□□□YFK/YGK)

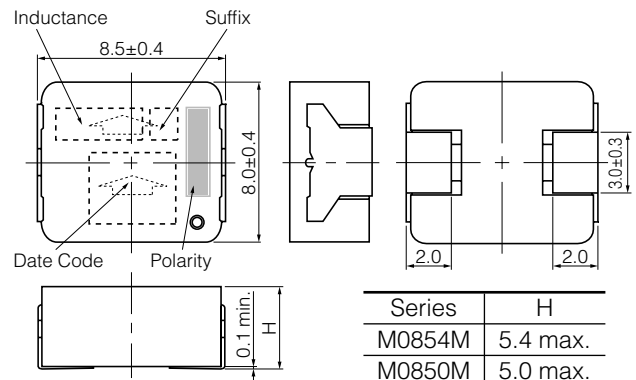

Series PCC-M1054M
Series PCC-M1050M
(ETQP5M□□□YFC/YGC)

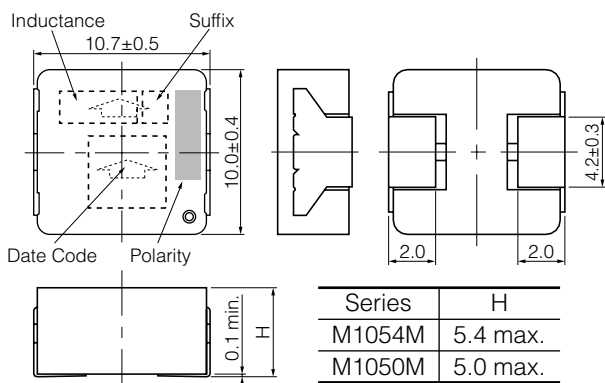

Series PCC-M1050ML
Series PCC-M1060ML
(ETQP5M□□□YLC/ETQP6M□□□YLC)

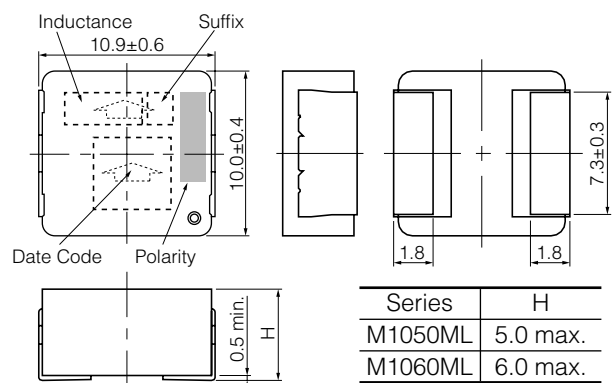

■ Recommended Land Pattern in mm (not to scale)

Dimensional tolerance unless noted : ± 0.5

Series PCC-M0530M

Series PCC-M0540M

(ETQP3M□□□YFP/ETQP4M□□□YFP)

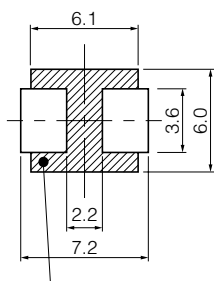

Don't wire on the pattern on shaded portion the PWB.

Series PCC-M0630M

Series PCC-M0645M

(ETQP3M□□□YFN/ETQP4M□□□YFN)

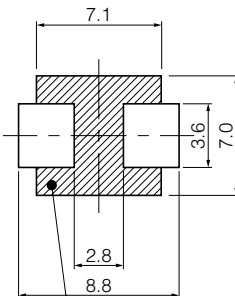

The same as the left.

Series PCC-M0754M

(ETQP5M□□□YFM)

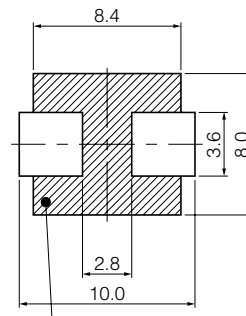

The same as the left.

Series PCC-M0854M

Series PCC-M0850M

(ETQP5M□□□YFK/YGK)

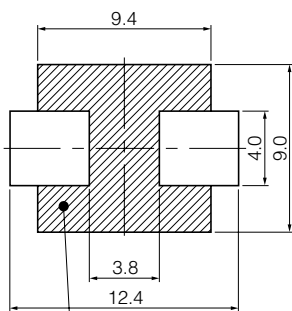

Don't wire on the pattern on shaded portion the PWB.

Series PCC-M1054M

Series PCC-M1050M

(ETQP5M□□□YFC/YGC)

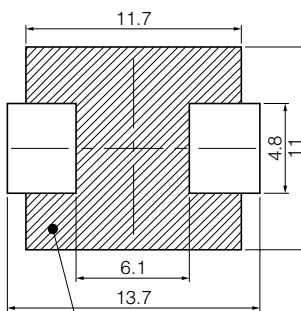

The same as the left.

Series PCC-M1050ML

Series PCC-M1060ML

(ETQP5M□□□YLC/ETQP5M□□□YLC)

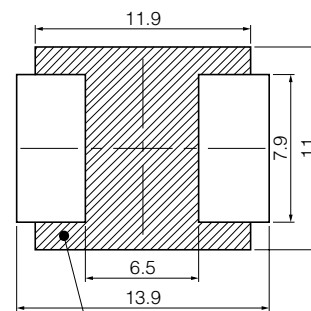

The same as the left.

■ Packaging Methods, Soldering Conditions and Safety Precautions (Power Choke Coils for high reliability use)

Please see Data Files

Power Choke Coil

Series: **PCC-M0630L (MC)**
PCC-M0630M (MC)



ETQP3LR33XFN ETQP3M1R5YFN

High power, Low loss , Compact size. Rust proof structure

Industrial Property : patents 21 (pending)

■ Features

- Downsize circuit space due to small and low profile package size
- Excellent DC bias performance and high reliability under high humidity
- Reduce number of components by high power and low loss
- Realize excellent performance by capability to high frequency range
- Low buzz noise
- RoHS compliant

■ Recommended Applications

- Servers, Routers, DC-DC converters for driving CPUs
- Laptop and desktop PC power supply
- Power supply modules

■ Standard Packing Quantity (Minimum Quantity/Packing Unit)

- 2000 pcs./box (2 reel)

■ Explanation of Part Numbers

- PCC-M0630L series

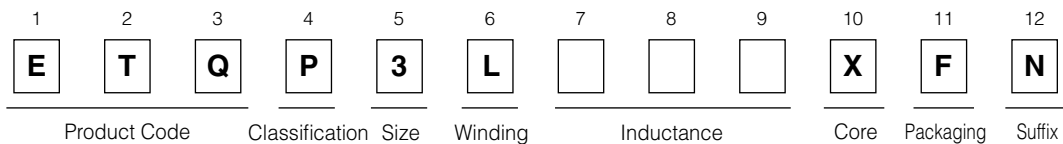

- PCC-M0630M series

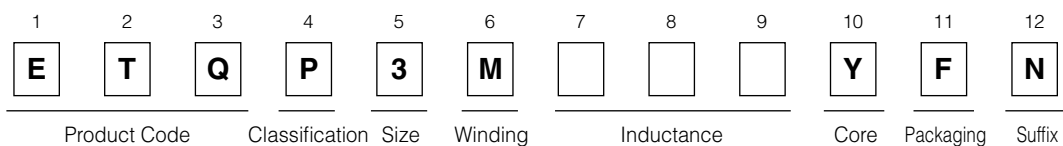

■ Standard Parts

Part No.	Inductance *1				Rated current (A) *2	DC resistance		Series
	L0		L1			Center (mΩ)	Tolerance (%)	
	(μH)	Tolerance (%)	(μH)	Measurement current (A)				
ETQP3LR33XFN	0.33	±20	0.28	17	17	2.0	±10	PCC-M0630L
ETQP3M1R5YFN	1.50	±20	1.36	5.6	5.6	11.0	±10	PCC-M0630M

(*1) Inductance is measured at 100 kHz

(*2) Rated current defines actual value of DC current, when temperature rise of coil becomes 40 K.

■ Performance Characteristics (Reference)

● PCC-M0630L (MC)

● Inductance vs DC Current

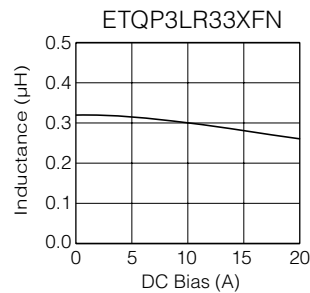

● Case Temperature vs DC Current

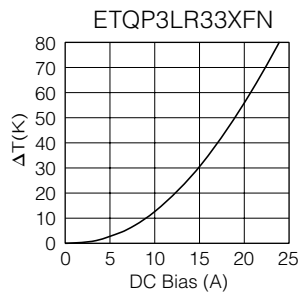

● PCC-M0630M (MC)

● Inductance vs DC Current

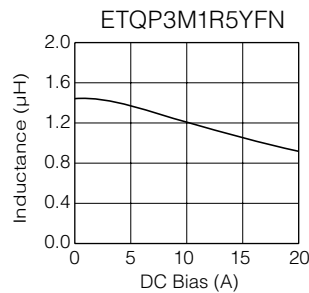

● Case Temperature vs DC Current*

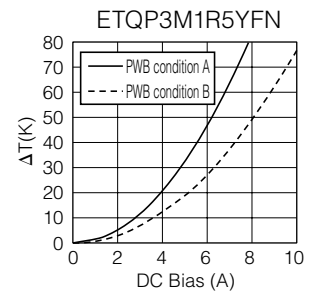

PWB condition A : FR4, single layer PWB, t=1.6mm *our specification
PWB condition B : FR4, four layer PWB, t=1.6mm

* Our temperature rise is specified with measurement of single layer PWB(condition A). Please refer to temperature rise curve V.S. current for the rated current ($\Delta T=15K$) and Reference value ($\Delta T=40K$). and when four layer PWB (condition B) is used, temperature rise is different from single layer PWB(condition A). Even we specify the rated current at our condition, the actual temperature rise of PCC may have different result due to thermal dissipation condition. We recommend customers to measure PCC temperature rise at application to confirm it.

■ Dimensions in mm (not to scale)

PCC-M0630L (MC) (ETQP3LR33XFN)

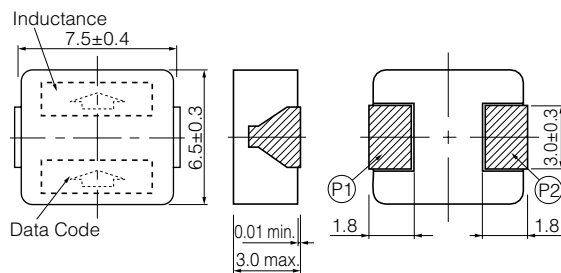

PCC-M0630M (MC) (ETQP3M1R5YFN)

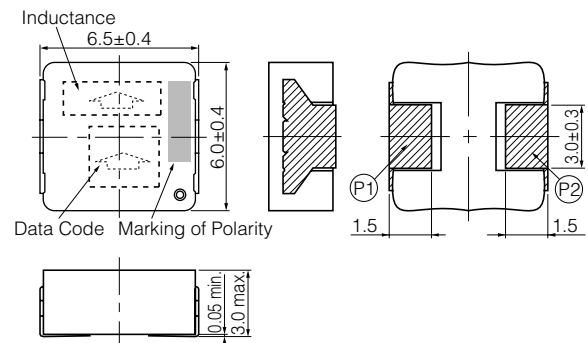

■ Connection

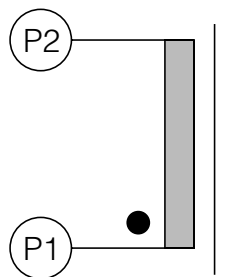

■ Recommended Land Pattern in mm (not to scale)

PCC-M0630L (MC) (ETQP3LR33XFN)

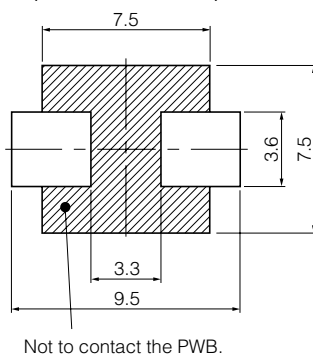

PCC-M0630M (MC) (ETQP3M1R5YFN)

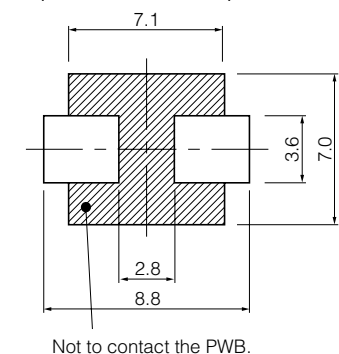

■ Packaging Methods, Soldering Conditions and Safety Precautions
(High reliability use : PCC-M0630M, Consumer use : PCC-M0630L)
Please see Data Files

⚠ Safety Precautions

(Common precautions for Power Choke Coils for high reliability use : Series DUST, Series MC)

- When using our products, no matter what sort of equipment they might be used for, be sure to make a written agreement on the specifications with us in advance. The design and specifications in this catalog are subject to change without prior notice.
- Do not use the products beyond the specifications described in this catalog.
- This catalog explains the quality and performance of the products as individual components. Before use, check and evaluate their operations when installed in your products.
- Install the following systems for a failsafe design to ensure safety if these products are to be used in equipment where a defect in these products may cause the loss of human life or other significant damage, such as damage to vehicles (automobile, train, vessel), traffic lights, medical equipment, aerospace equipment, electric heating appliances, combustion/gas equipment, rotating equipment, and disaster/crime prevention equipment.
- * Systems equipped with a protection circuit and a protection device
- * Systems equipped with a redundant circuit or other system to prevent an unsafe status in the event of a single fault

⚠ Precautions for use

1. Provision to abnormal condition

This power choke coil itself does not have any protective function in abnormal condition such as overload, short-circuit and open-circuit conditions, etc.

Therefore, it shall be confirmed as the end product that there is no risk of smoking, fire, dielectric withstand voltage, insulation resistance, etc. in abnormal conditions to provide protective devices and/or protection circuit in the end product.

2. Temperature rise

Temperature rise of power choke coil depends on the installation condition in end products. It shall be confirmed in the actual end product that temperature rise of power choke coil is in the limit of specified temperature class.

3. Dielectric strength

Dielectric withstanding test with higher voltage than specific value will damage Insulating material and shorten its life.

4. Water

This Power choke coil must not be used in wet condition by water, coffee or any liquid because insulation strength becomes very low in the condition.

5. Potting

If this power choke coil is potted in some compound, coating material of magnet wire might be occasionally damaged. Please ask us if you intend to pot this power choke coil.

6. Model

When this power choke coil was used in a similar or new product to the original one, sometimes it might be unable to satisfy the specifications due to difference of condition of usage.

Please ask us if you would use this power choke coil in the manner such as above.

7. Drop

If the power choke coil suffered mechanical stress such as drop, characteristics may become poor (due to damage on coil bobbin, etc.). Never use such stressed power choke coil.

8. Printed circuit board design

- ① Land pattern and Via which exceed Operating Voltage, should not be placed top layer PWB under the products for keeping isolation between inside coil and surface of PWB. (**Series DUST**)
- ② To the opposing part in this power choke coil bottom please install neither pattern nor the beer, etc. (**Series MC**)

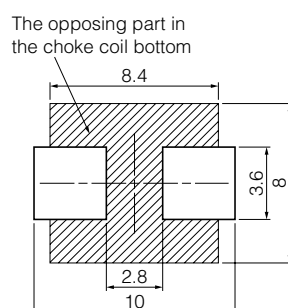

- ③ Parts arranged around this power choke coil do not touch the surface of this power choke coil (Top side and side).
(Series MC)

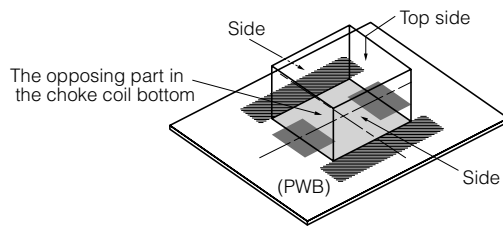

- ④ This power choke coil is different from the ferrite core-type that installs general concentration GAP. It has the leakage magnetic bunch distribution of the choke coil to the vertical direction. Please note it enough when parts and the circuit compositions in using the influence of the leakage flux is received easily.

9. Solvent (Series MC)

If this power choke coil is dipped in the cleaning agent, and the coating agent of the toluene and the xylene system, there is a possibility that the performance decreases greatly. Please ask us if you intend to pot this power choke coil.

10. Static electricity measures (Series MC)

① Circuit design

Please set up the ESD measures parts such as capacitors in the former steps of this power choke coil for static electricity when there is a possibility that static electricity is impressed to the choke coil on the circuit. Moreover, please consult our company about such a case once.

② Treatment with single

I hope the static electricity measures the handling of this power choke coil single. (process and equipment) There is a possibility that the characteristic changes when the voltage of 200V or more is impressed to this power choke coil. Please handle 200V or less.

11. Other using environment

This power choke coil doesn't become a design that considers use in the following, special environment. Therefore, please do not use it in the following special environment.

- Use in place where a lot of causticity gases such as sea breeze, Cl₂, H₂S, NH₃, SO₂, and Nox exist.
- Use in place where out-of-door exposure and direct sunshine strike.

12. Keeping environment

If this power choke coil is kept under following environment and condition, there is a possibility that the performance and soldering decreases greatly.

- Keep in place where a lot of causticity gases such as sea breeze, Cl₂, H₂S, NH₃, SO₂, and Nox exist.
- Keep in place where out-of-door exposure and direct sunshine strike.

<Package markings>

Package markings include the product number, quantity, and country of origin. In principle, the country of origin should be indicated in English.

Power Choke Coil

Series: **PCC-M0512W (MC)**

High power, Low loss, Low-profile



■ Features

- Small type (5.4×5.15×H1.2 mm)
- High power (2.2 A to 5.5 A)
- Low loss (R_{DC} :19.2 to 168.0 mΩ)
- Suitable for high frequency circuit (up to 1 MHz)
- Low buzz noise due to its gap-less structure
- RoHS compliant

■ Recommended Applications

- HDD, Tablet PC power supply modules
- Servers, Routers, DC-DC converters for driving CPUs

■ Standard Packing Quantity (Minimum Quantity/Packing Unit)

- 6000 pcs./box (2 reel)

■ Explanation of Part Numbers

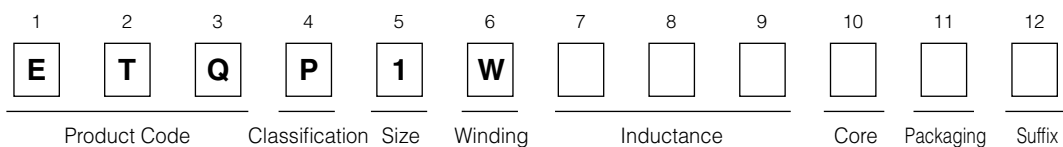

■ Standard Parts

Part No.	Inductance (at 20 °C)*1			Rated current (A)*2	DC resistance (at 20 °C) (mΩ) max.
	L0 at 0A	L1*3			
	(μH)	(μH)	Measurement current (A)		
ETQP1WR47WFP	0.47±20 %	(0.42)	5.5	5.5	19.2
ETQP1W1R0WFP	1.00±20 %	(0.87)	4.4	4.4	46.5
ETQP1W2R2WFP	2.20±20 %	(1.80)	3.4	3.4	77.3
ETQP1W3R3WFP	3.30±20 %	(2.70)	2.8	2.8	103.0
ETQP1W4R7WFP	4.70±20 %	(3.90)	2.2	2.2	168.0

(*1) Inductance is measured at 100 kHz.

(*2) Rated current defines actual value of DC current, when temperature rise of coil becomes 40 K. (Method A)

(*3) Reference only

(*4) Method A (PANASONIC's standard measurement conditions)

■ Performance Characteristics (Reference)

Inductance vs DC Current

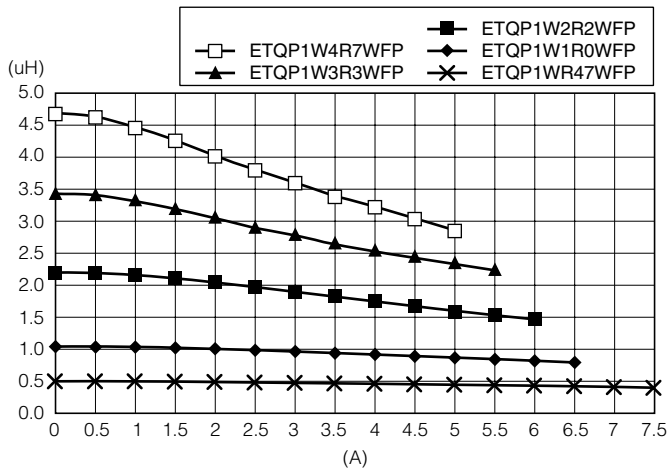

Case Temperature vs DC Current (Method A)

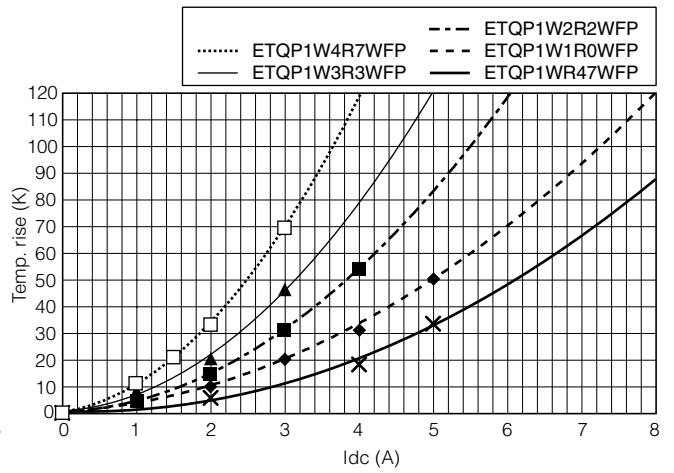

■ Dimensions in mm (not to scale)

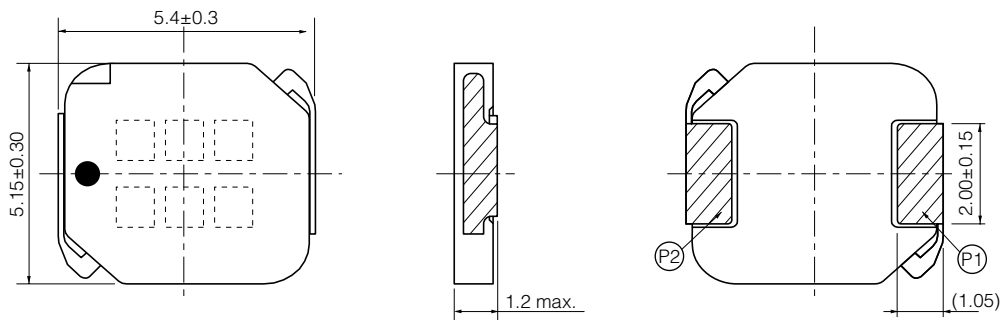

■ Connection

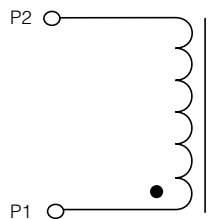

■ Recommended Land Pattern in mm (not to scale)

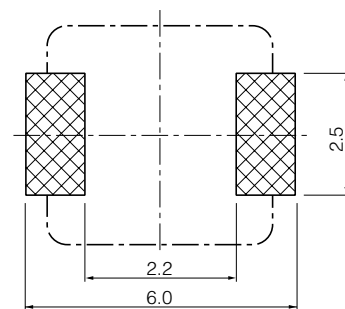

■ Packaging Methods, Soldering Conditions and Safety Precautions (Power Choke Coils for Consumer use)

Please see Data Files

Power Choke Coil

Series: **PCC-M0630W (MC)**

High power, Low loss, Low-profile



■ Features

- Small type (7.3×6.6×H3.0 mm)
- High power (5.5 A to 20.0 A)
- Low loss (R_{DC} : 3.3 to 35.0 mΩ)
- Suitable for high frequency circuit (up to 1 MHz)
- Low buzz noise due to its gap-less structure
- RoHS compliant

■ Recommended Applications

- Notebook PC power supply modules
- Servers, Routers, DC-DC converters for driving CPUs

■ Standard Packing Quantity (Minimum Quantity/Packing Unit)

- 2000 pcs./box (2 reel)

■ Explanation of Part Numbers

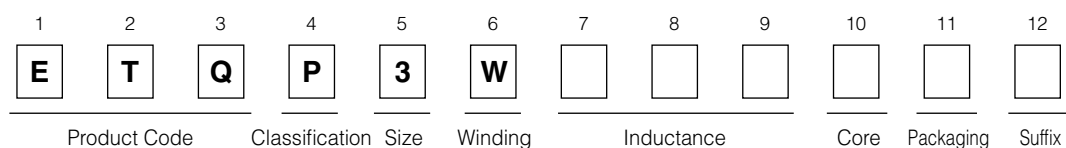

■ Standard Parts

Part No.	Inductance (at 20 °C)*1					DC resistance (at 20 °C) (mΩ)	
	L0 at 0A	L1*4		Rated current (A)*2 (typ.)	Rated current (ref) (A)*3 (typ.)		
	(μH)	(μH)	Measurement current (A)			typ.	max.
ETQP3WR33WFN	0.33±20 %	(0.27)	(20.0)	13.7	20	3.3	3.9
ETQP3WR47WFN	0.47±20 %	(0.38)	(17.0)	11.6	17	3.8	4.2
ETQP3WR68WFN	0.68±20 %	(0.55)	(14.0)	9.6	14	4.9	5.5
ETQP3WR82WFN	0.82±20 %	(0.66)	(13.0)	8.9	13	6.7	8.0
ETQP3W1R0WFN	1.0±20 %	(0.84)	(11.8)	8.1	11.8	6.9	7.9
ETQP3W1R5WFN	1.5±20 %	(1.24)	(9.6)	6.6	9.6	9.8	13.0
ETQP3W2R2WFN	2.2±20 %	(1.80)	(8.5)	5.8	8.5	15.5	17.8
ETQP3W3R3WFN	3.3±20 %	(2.69)	(7.0)	4.8	7	25.0	28.8
ETQP3W4R7WFN	4.7±20 %	(3.89)	(5.5)	3.8	5.5	35.0	40.3

(*1) Inductance is measured at 100 kHz.

(*2) Rated current defines actual value of DC current, when temperature rise of coil becomes 40 K. (Method A)

(*3) Rated current defines actual value of DC current, when temperature rise of coil becomes 40 K. (Method B)

(*4) Reference only

(*5) Method A (PANASONIC's standard measurement conditions),

Method B (high heat dissipation measurement) is different from Method A by the measurement methods.

In normal application condition, the part's temperature depends on circuit design and heat dissipation condition.

This condition shall be verified by the worst operational condition.

■ Performance Characteristics (Reference)

Inductance vs DC Current

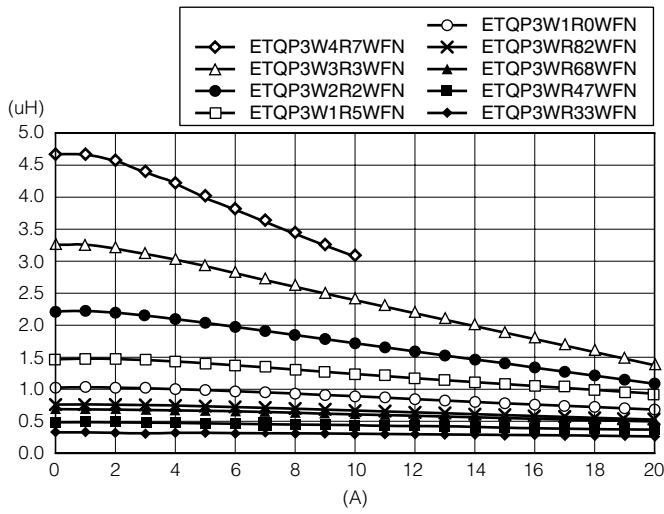

Case Temperature vs DC Current (Method A)

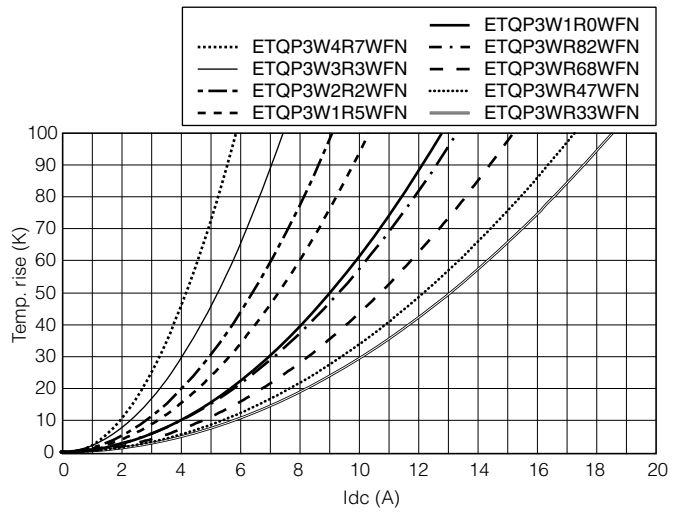

■ Dimensions in mm (not to scale)

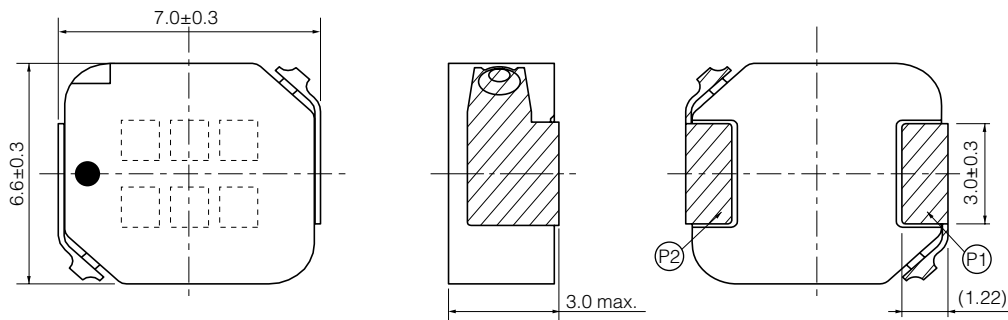

■ Connection

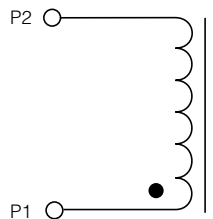

■ Recommended Land Pattern in mm (not to scale)

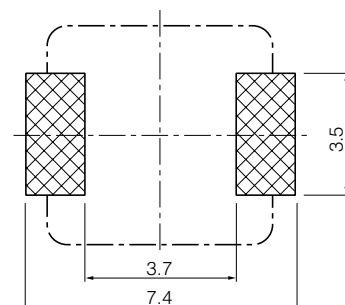

■ Packaging Methods, Soldering Conditions and Safety Precautions (Power Choke Coils for Consumer use)

Please see Data Files

Power Choke Coil

Series: **PCC-M0730L (MC)**

Small mounting size for multi-phase DC-DC converter circuits



■ Features

- Small type (8.7×7.0×H3.0 mm)
- High power (22 A)
- Low loss (R_{DC} :1.12 mΩ)
- Tighter DCR tolerance (±7 %)
- Suitable for high frequency circuit (up to 1 MHz)
- Low buzz noise due to its gap-less structure
- RoHS compliant

■ Recommended Applications

- Notebook PC power supply modules
- Servers, Routers, DC-DC converters for driving CPUs

■ Standard Packing Quantity (Minimum Quantity/Packing Unit)

- 3000 pcs./box (2 reel)

■ Explanation of Part Numbers

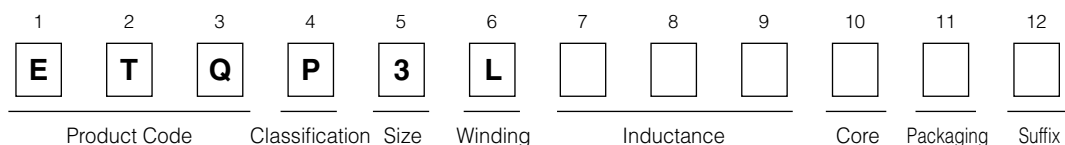

■ Standard Parts

Part No.	Inductance (at 20 °C)*1			Rated current (A)*2	DC resistance (at 20 °C) (mΩ)
	L0 at 0A	L1*3			
	(μH)	(μH)	Measurement current (A)		
ETQP3LR24CFM	0.24±20 %	(0.19)	22	22	1.12±7 %

(*1) Inductance is measured at 1.0 MHz.

(*2) Rated current defines actual value of DC current, when temperature rise of coil becomes 40 K.

(*3) Reference Only

■ Performance Characteristics (Reference)

Inductance vs DC Current

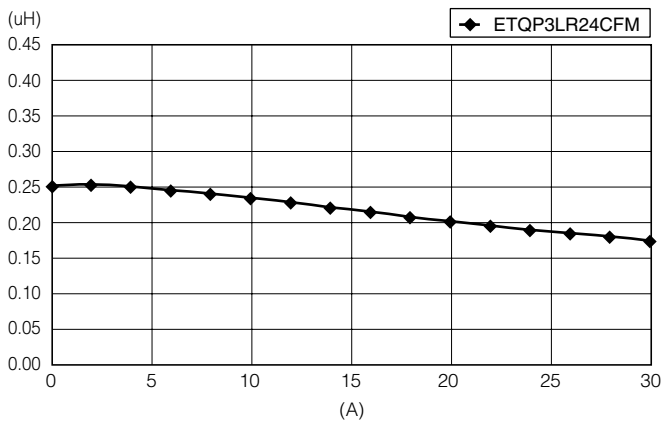

Case Temperature vs DC Current

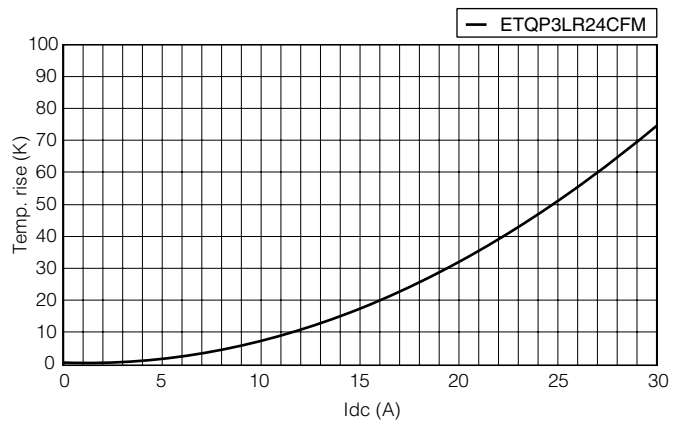

■ Dimensions in mm (not to scale)

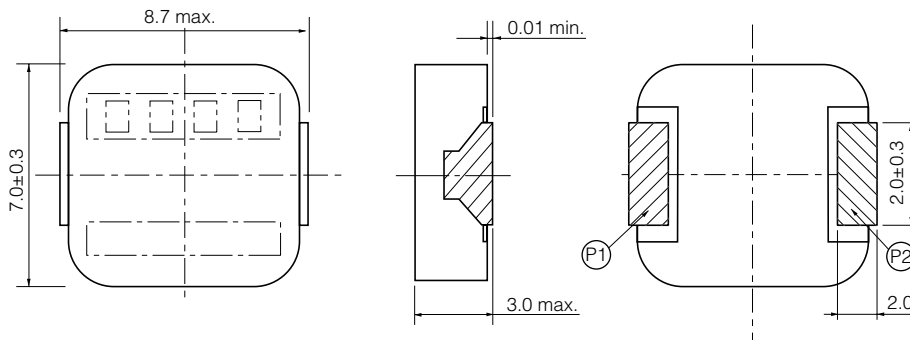

■ Connection

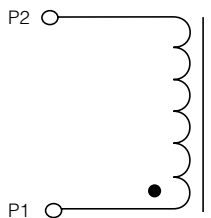

■ Recommended Land Pattern in mm (not to scale)

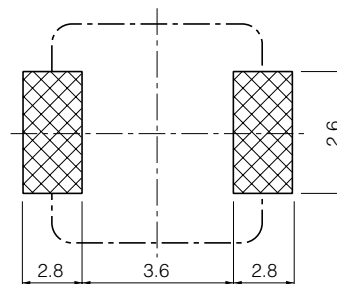

■ Packaging Methods, Soldering Conditions and Safety Precautions (Power Choke Coils for Consumer use)
Please see Data Files

Power Choke Coil

Series: **PCC-M074L (MC)**
Low DCR Type

Small mounting size for multi-phase DC-DC converter circuits



■ Features

- Small type (8.7×7.0×H4.0 mm)
- High power (17 A to 24 A)
- Low loss (R_{DC} :1.0 to 1.5 mΩ)
- Tighter DCR tolerance ($\pm 7\%$)
- Suitable for high frequency circuit (up to 1 MHz)
- Low buzz noise due to its gap-less structure
- RoHS compliant

■ Recommended Applications

- Notebook PC power supply modules
- Servers, Routers, DC-DC converters for driving CPUs

■ Standard Packing Quantity (Minimum Quantity/Packing Unit)

- 3000 pcs./box (2 reel)

■ Explanation of Part Numbers

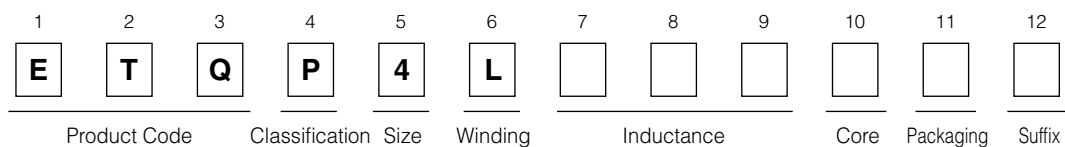

■ Standard Parts

Part No.	Inductance (at 20 °C)*1			Rated current (A)*2	DC resistance (at 20 °C) (mΩ)
	L0 at 0A	L1			
	(μH)	(μH)	Measurement current (A)		
ETQP4LR24AFM	0.24±20 %	(0.20)	24	24	1.00±7 %
ETQP4LR36AFM	0.36±20 %	(0.30)	20	20	1.35±7 %
ETQP4LR42AFM	0.42±20 %	(0.35)	17	17	1.50±7 %

(*1) Inductance is measured at 100 kHz.

(*2) Rated current defines actual value of DC current, when temperature rise of coil becomes 40 K.

Performance Characteristics (Reference)

Inductance vs DC Current

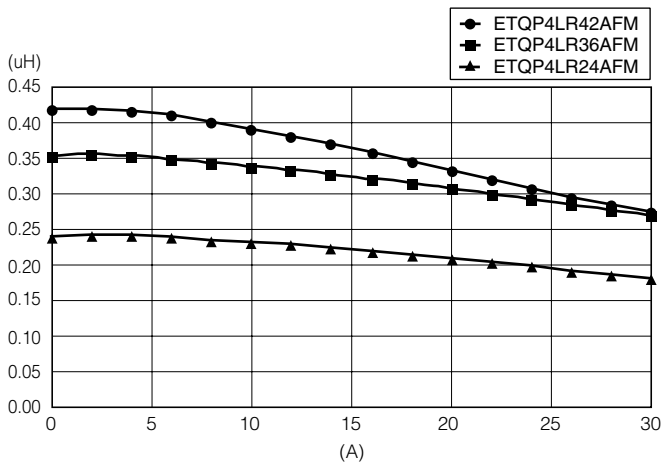

Case Temperature vs DC Current

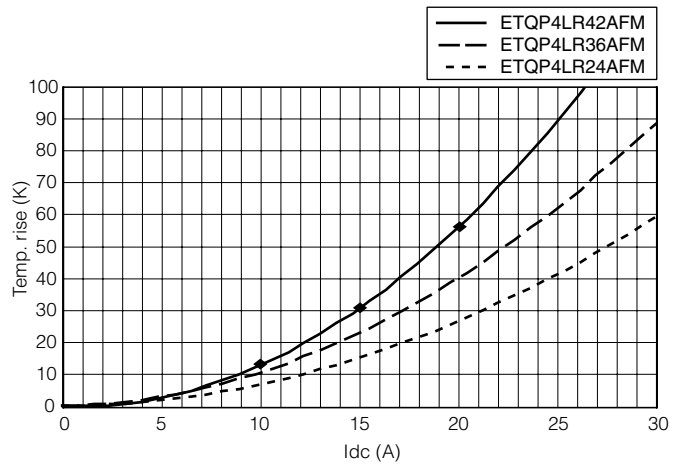

Dimensions in mm (not to scale)

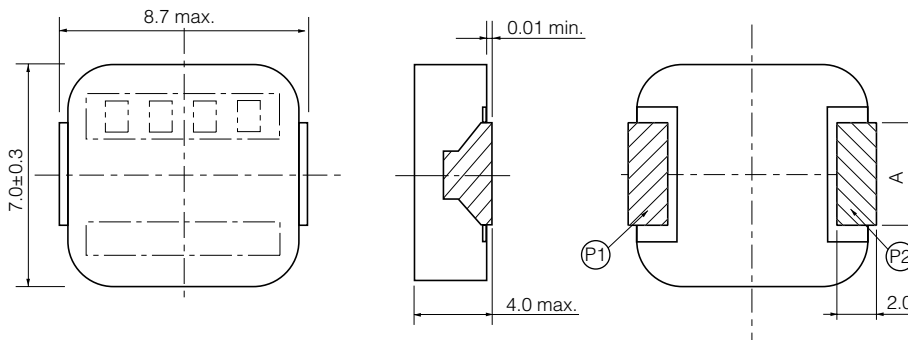

Part No.	A
ETQP4LR24AFM	3.0±0.3
ETQP4LR36AFM	2.0±0.3
ETQP4LR42AFM	

Connection

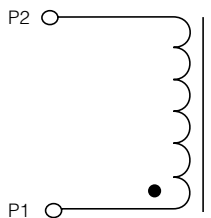

Recommended Land Pattern in mm (not to scale)

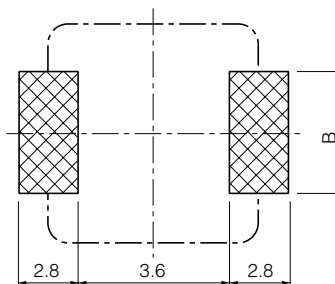

Part No.	B
ETQP4LR24AFM	3.6
ETQP4LR36AFM	2.6
ETQP4LR42AFM	

Packaging Methods, Soldering Conditions and Safety Precautions (Power Choke Coils for Consumer use)

Please see Data Files

Power Choke Coil

Series: **PCC-M104L (MC)**

Small mounting size for multi-phase DC-DC converter circuits



■ Features

- Small type (11.5×10.0×H4.0 mm)
- High power (21 A to 28 A)
- Low loss (R_{DC} : 0.7 to 1.56 m Ω)
- Tighter DCR tolerance ($\pm 5\%$ to $\pm 10\%$)
- Suitable for high frequency circuit (up to 1 MHz)
- Low buzz noise due to its gap-less structure
- RoHS compliant

■ Recommended Applications

- Servers, Routers, DC-DC converters for driving CPUs
- Notebook PC power supply modules

■ Standard Packing Quantity (Minimum Quantity/Packing Unit)

- 2000 pcs./box (2 reel)

■ Explanation of Part Numbers

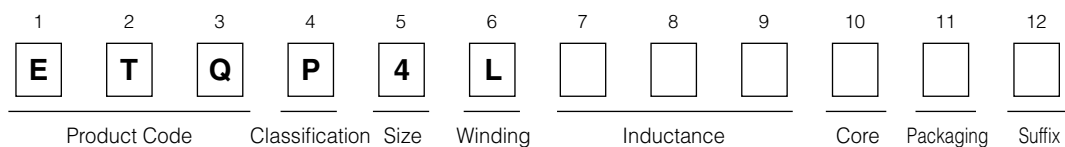

■ Standard Parts

Part No.	Inductance (at 20 °C)*1					Rated current (A)*2	DC resistance (at 20 °C) (m Ω)
	L0 at 0A	L1		L2 (Reference)			
	(μ H)	(μ H)	Measurement current (A)	(μ H)	Measurement current (A)		
ETQP4LR19WFC	(0.20)	0.19 \pm 20 %	21	(0.17)	30	28	0.70 \pm 10 %
ETQP4LR36WFC	(0.37)	0.36 \pm 20 %	17	(0.34)	24	24	1.10 \pm 5 %
ETQP4LR56WFC	(0.60)	0.56 \pm 20 %	15	(0.53)	21	21	1.56 \pm 5 %
ETQP4LR45XFC	0.45+20/-25 %	—	—	(0.38)	25	25	1.10 \pm 5 %

(*1) Inductance is measured at 100 kHz.

(*2) Rated current defines actual value of DC current, when temperature rise of coil becomes 40 K.

Design and specifications are each subject to change without notice. Ask factory for the current technical specifications before purchase and/or use. Should a safety concern arise regarding this product, please be sure to contact us immediately.

Performance Characteristics (Reference)

Inductance vs DC Current

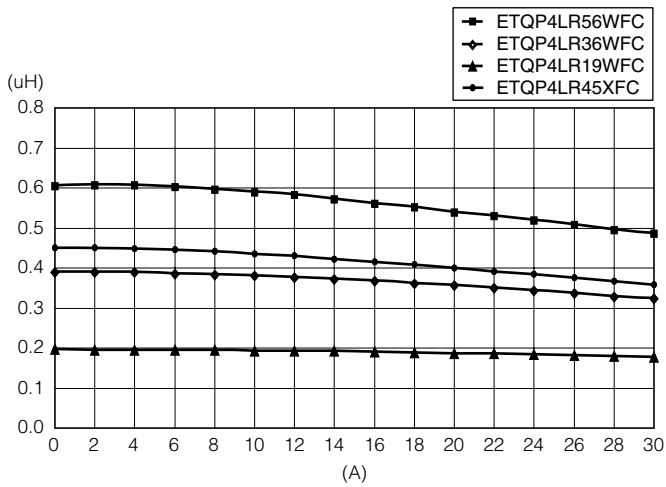

Case Temperature vs DC Current

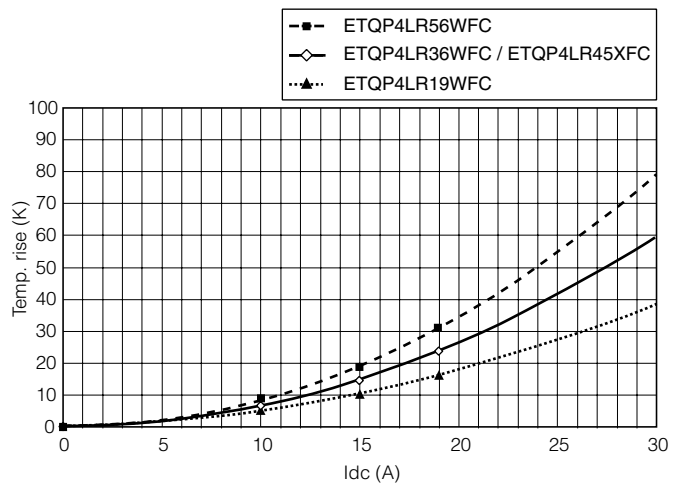

Dimensions in mm (not to scale)

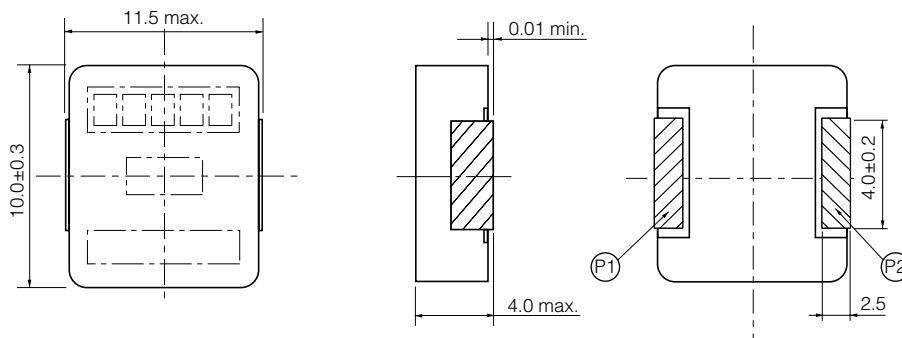

Connection

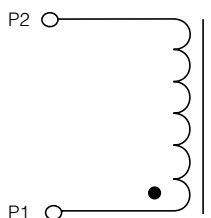

Recommended Land Pattern in mm (not to scale)

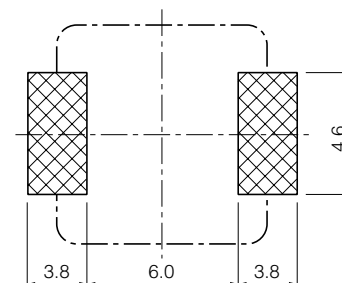

Packaging Methods, Soldering Conditions and Safety Precautions (Power Choke Coils for Consumer use)

Please see Data Files

Power Choke Coil

Series: **PCC-M104L (MC)**
Low DCR Type

Small mounting size for multi-phase DC-DC converter circuits



■ Features

- Small type (11.7×10.0×H4.0 mm)
- High power (21 A to 30 A)
- Low loss (R_{DC} : 0.76 to 1.58 mΩ)
- Tighter DCR tolerance (±5 %)
- Suitable for high frequency circuit (up to 1 MHz)
- Low buzz noise due to its gap-less structure
- RoHS compliant

■ Recommended Applications

- Notebook PC power supply modules
- Servers, Routers, DC-DC converters for driving CPUs

■ Standard Packing Quantity (Minimum Quantity/Packing Unit)

- 2000 pcs./box (2 reel)

■ Explanation of Part Numbers

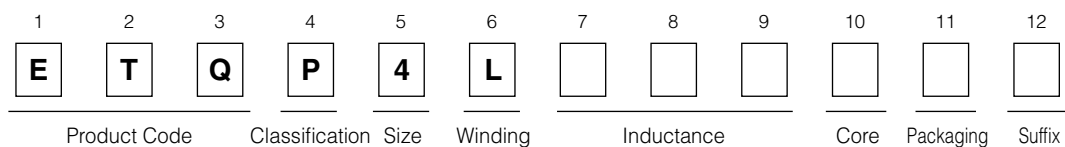

■ Standard Parts

Part No.	Inductance (at 20 °C)*1			Rated current (A)*2	DC resistance (at 20 °C) (mΩ)
	L0 at 0A	L1			
	(μH)	(μH)	Measurement current (A)		
ETQP4LR36AFC	0.36±20 %	(0.29)	30	30	0.76±5 %
ETQP4LR68XFC	0.68±20 %	(0.59)	21	21	1.58±5 %

(*1) Inductance is measured at 100 kHz.

(*2) Rated current defines actual value of DC current, when temperature rise of coil becomes 40 K.

■ Performance Characteristics (Reference)

Inductance vs DC Current

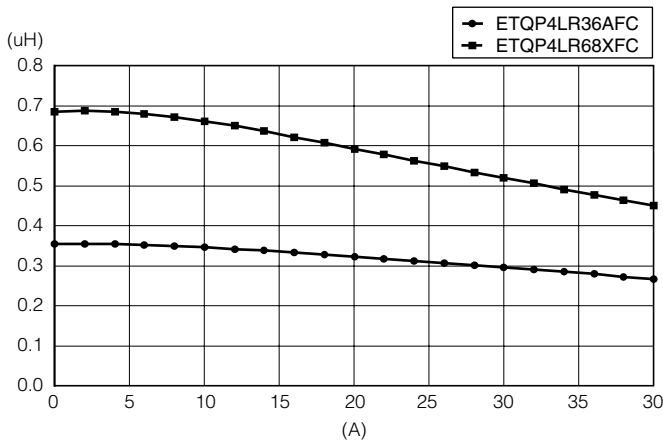

Case Temperature vs DC Current

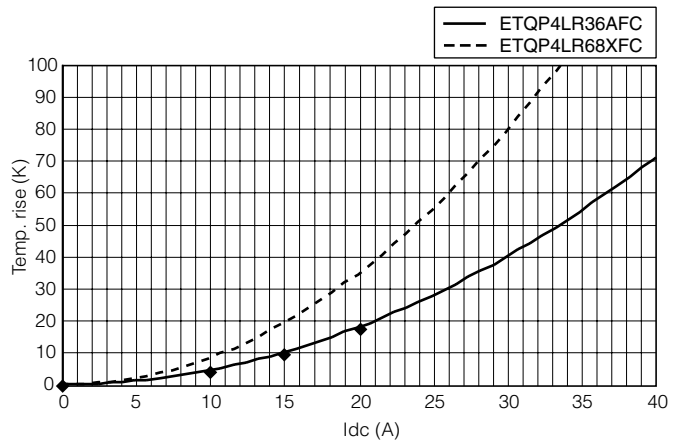

■ Dimensions in mm (not to scale)

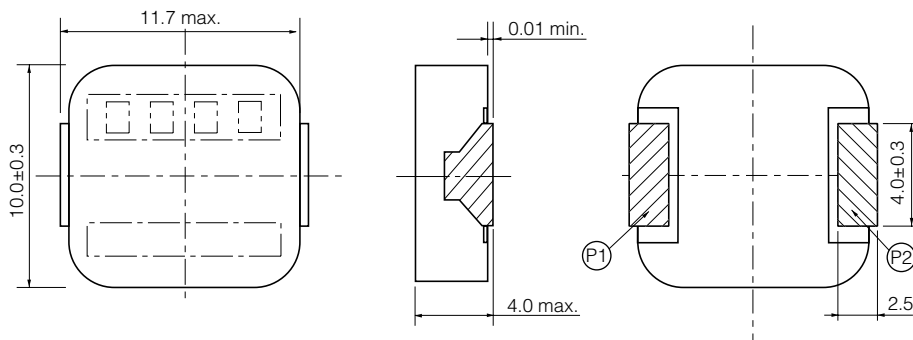

■ Connection

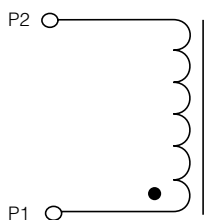

■ Recommended Land Pattern in mm (not to scale)

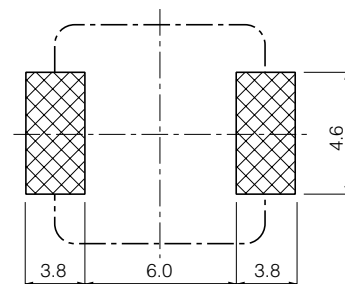

■ Packaging Methods, Soldering Conditions and Safety Precautions (Power Choke Coils for Consumer use)

Please see Data Files

Power Choke Coil

Series: **PCC-M104W (MC)**

High power, Low loss, Low-profile



Industrial Property : patents 10 (Registered 8 / Pending 2)

■ Features

- Small type (11.0×10.0×H4.0 mm)
- High power (13 A)
- Low loss (R_{DC} : 4.0 m Ω)
- Suitable for high frequency circuit (up to 1 MHz)
- Low buzz noise due to its gap-less structure
- RoHS compliant

■ Recommended Applications

- Notebook PC power supply modules
- Servers, Routers, DC-DC converters for driving CPUs

■ Standard Packing Quantity (Minimum Quantity/Packing Unit)

- 1000 pcs./box (2 reel)

■ Explanation of Part Numbers

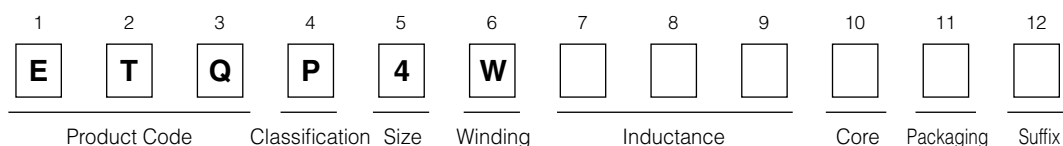

■ Standard Parts

Part No.	Inductance (at 20 °C)*1			Rated current (A)*2	DC resistance (at 20 °C) (m Ω) max.
	L0 at 0A	L1*3			
	(μ H)	(μ H)	Measurement current (A)		
ETQP4W1R5WFC	1.5±20 %	(1.27)	13	13	4.0±15 %

(*1) Inductance is measured at 100 kHz.

(*2) Rated current defines actual value of DC current, when temperature rise of coil becomes 40 K. (Method A)

(*3) Reference only

(*4) Method A (PANASONIC's standard measurement conditions)

■ Performance Characteristics (Reference)

Inductance vs DC Current

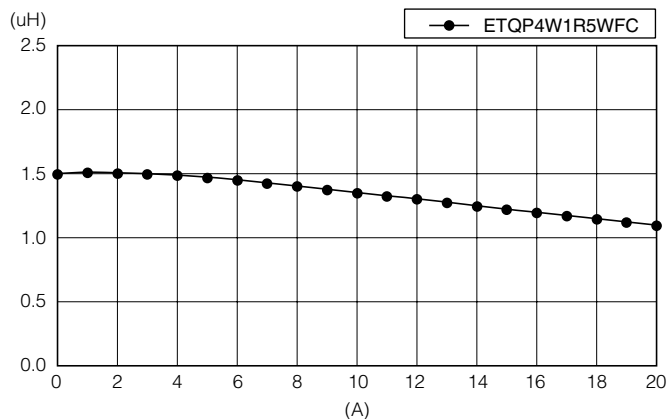

Case Temperature vs DC Current (Method A)

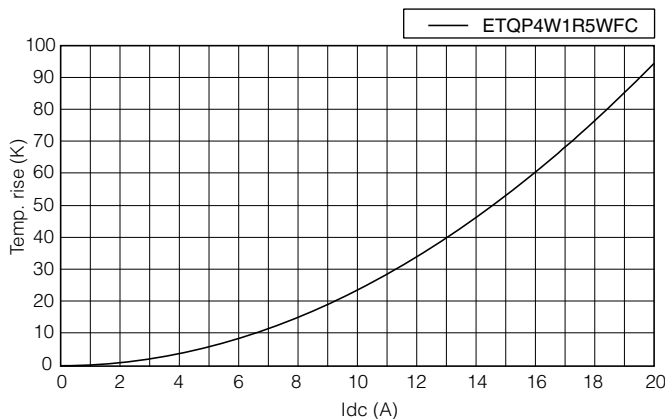

■ Dimensions in mm (not to scale)

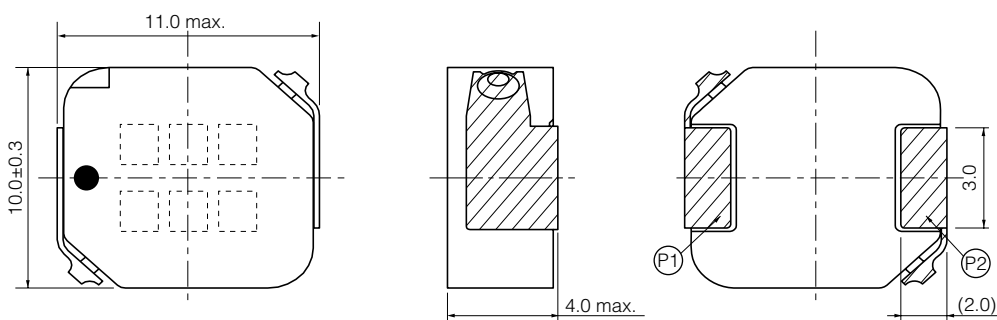

■ Connection

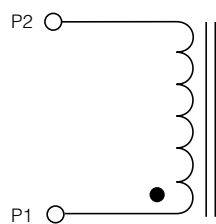

■ Recommended Land Pattern in mm (not to scale)

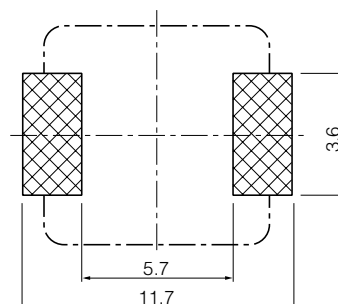

■ Packaging Methods, Soldering Conditions and Safety Precautions (Power Choke Coils for Consumer use)

Please see Data Files

Power Choke Coil

Series: **PCC-M125L (MC)**



High power, Low loss, Low profile

■ Features

- High power (25 A to 30 A)
- Low loss (R_{DC} :0.8 to 1.1 m Ω)
- Narrow R_{DC} tolerance ($\pm 5\%$ to $\pm 7\%$)
- Low profile (14.5×12.5×H5.0 mm)
- High frequency (up to 1 MHz)
- Low buzz noise due to its gap-less structure
- RoHS compliant

■ Recommended Applications

- Servers, Routers, DC-DC converters for driving CPUs
- Notebook PC power supply modules

■ Standard Packing Quantity (Minimum Quantity/Packing Unit)

- 1000 pcs./box (2 reel)

■ Explanation of Part Numbers

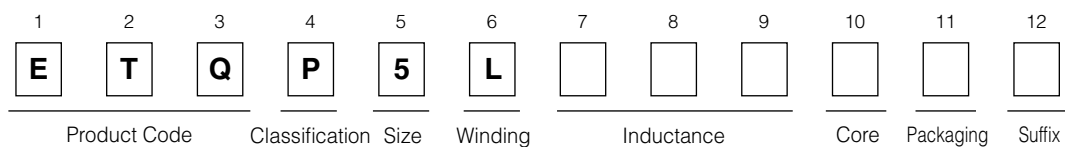

■ Standard Parts

Part No.	Inductance (at 20 °C)*1				Rated current (A)*2	DC resistance (at 20 °C) (m Ω)
	L1		L2 (Reference)			
	(μ H)	Measurement current (A)	(μ H)	Measurement current (A)		
ETQP5LR50XFA	0.50 \pm 20 %	30	(0.46)	42	30	0.80 \pm 7 %
ETQP5LR60XFA	0.60 \pm 20 %	30	(0.54)	42	27	1.10 \pm 5 %

(*1) Inductance is measured at 100 kHz.

(*2) Rated current defines actual value of DC current, when temperature rise of coil becomes 40 K.

Design and specifications are each subject to change without notice. Ask factory for the current technical specifications before purchase and/or use. Should a safety concern arise regarding this product, please be sure to contact us immediately.

■ Performance Characteristics (Reference)

Inductance vs DC Current

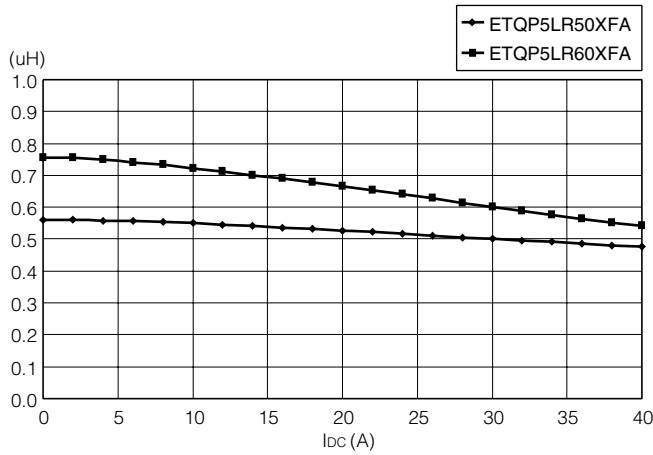

Case Temperature vs DC Current

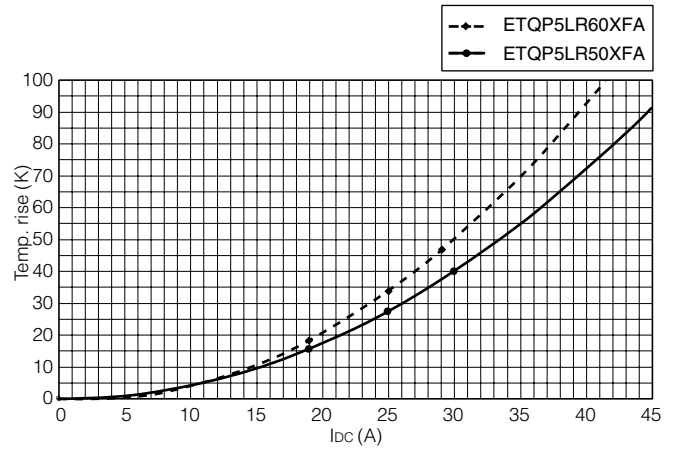

■ Dimensions in mm (not to scale)

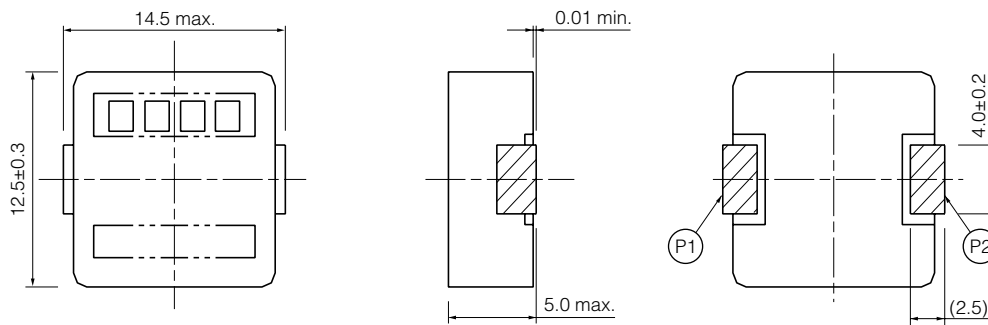

■ Connection

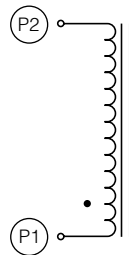

■ Recommended Land Pattern in mm (not to scale)

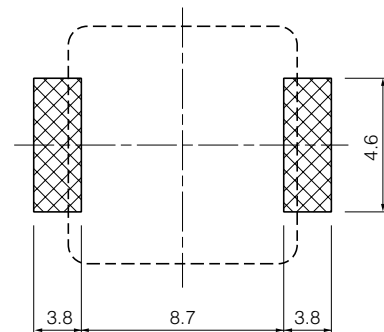

■ Packaging Methods, Soldering Conditions and Safety Precautions (Power Choke Coils for Consumer use)

Please see Data Files

Power Choke Coil

Series: **PCC-D124H (NX1)**

Low profile, High power, Low loss



■ Features

- High power, high inductance (No saturation performance limitation due to metal dust core)
(17 A to 32 A/1.25 μ H to 0.32 μ H)
- Low loss due to low R_{DC} (using flat wire)
- Low buzz noise due to its gap-less structure
- Surface mount, low profile
(H) 3.9 mm×(L)13.0 mm×(W)12.9 mm
- RoHS compliant

■ Recommended Applications

- DC-DC converter for CPU in PCs
- Thin on-board power supply modules for servers

■ Standard Packing Quantity

- 500 pcs./Reel

■ Explanation of Part Numbers

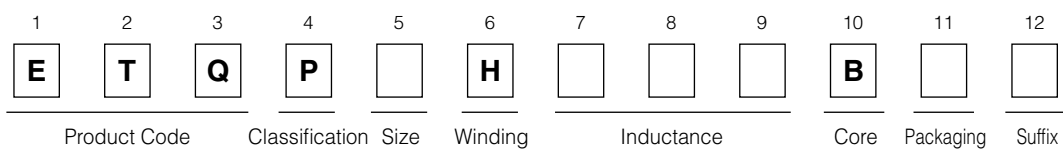

■ Standard Parts

Part No.	Inductance (at 20 °C)*1					Rated current (A)*2	DC resistance (at 20 °C) (m Ω) max.
	L1			L2 (Reference)			
	(μ H)	Tolerance (%)	Measurement current (A)	(μ H)	Measurement current (A)		
ETQP3H0R4BFA	0.36	±20	23	0.32	32	23	1.04
ETQP3H0R8BFA	0.80		16	0.71	22	16	2.33
ETQP3H1R4BFA	1.43		12	1.25	17	12	4.52

(*1) Inductance is measured at 100 kHz.

(*2) Rated current defines actual value of DC current, when temperature rise of coil becomes 40 K.

Design and specifications are each subject to change without notice. Ask factory for the current technical specifications before purchase and/or use. Should a safety concern arise regarding this product, please be sure to contact us immediately.

■ Performance Characteristics (Reference)

Inductance vs DC Current

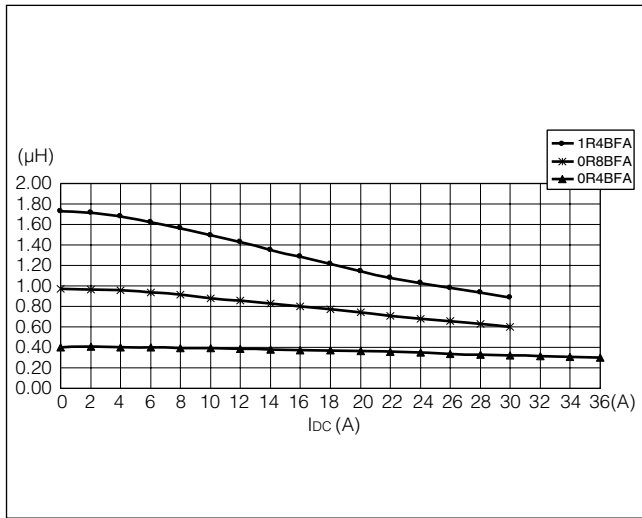

Case temperature vs DC Current

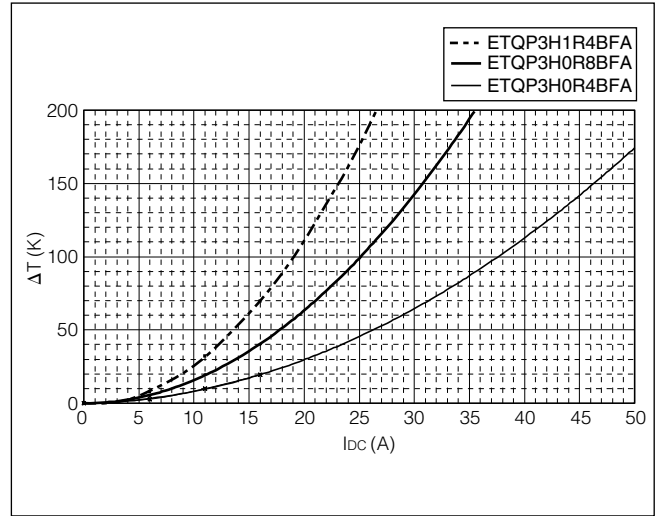

■ Dimensions in mm (not to scale)

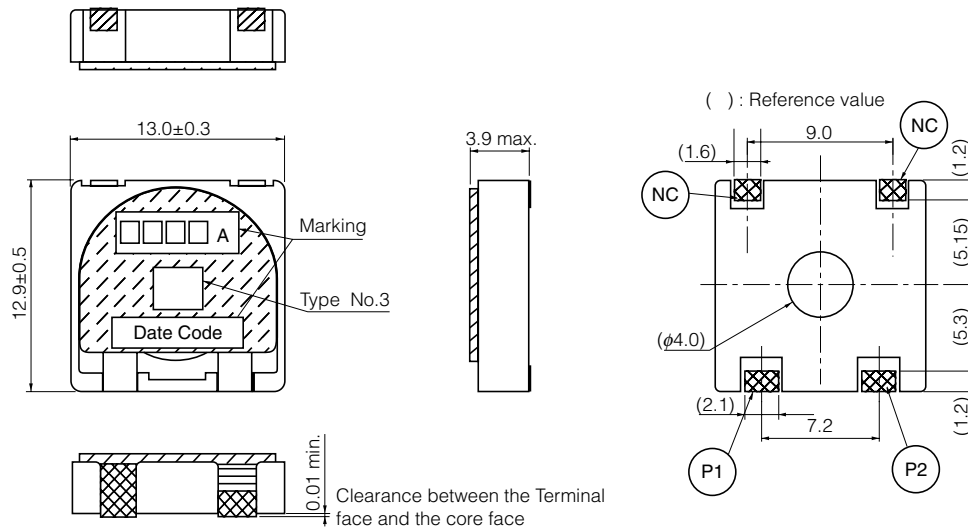

■ Connection

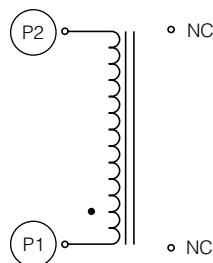

■ Recommended Land Pattern in mm (not to scale)

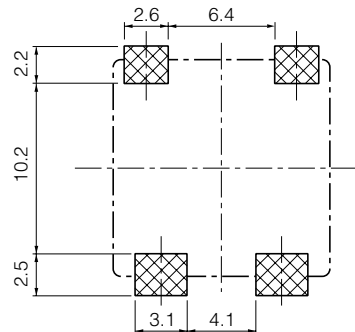

■ Packaging Methods, Soldering Conditions and Safety Precautions (Power Choke Coils for Consumer use)

Please see Data Files

Power Choke Coil

Series: **PCC-D125H (NX2)**

Low profile, High power, Low loss



■ Features

- High power, high inductance (No saturation performance limitation due to metal dust core)
(17 A to 50 A/2.12 μ H to 0.24 μ H)
- Low loss due to low R_{DC} (using flat wire)
- Low buzz noise due to its gap-less structure
- Surface mount, low profile
(H) 4.9 mm×(L)13.0 mm×(W)12.9 mm
- RoHS compliant

■ Recommended Applications

- DC-DC converter for CPU in PCs
- Thin on-board power supply modules for servers

■ Standard Packing Quantity

- 500 pcs./Reel

■ Explanation of Part Numbers

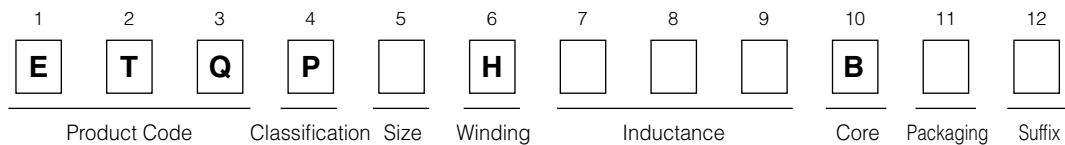

■ Standard Parts

Part No.	Inductance (at 20 °C)*1					Rated current (A)*2	DC resistance (at 20 °C) (m Ω) max.
	L1			L2 (Reference)			
	(μ H)	Tolerance (%)	Measurement current (A)	(μ H)	Measurement current (A)		
ETQP2H0R3BFA	0.29	±20	36	0.24	50	36	0.54
ETQP2H0R7BFA	0.69		21	0.59	29	21	1.30
ETQP2H1R2BFA	1.22		16	1.04	22	16	2.27
ETQP2H1R8BFA	1.83		14	1.49	20	14	3.48
ETQP2H2R6BFA	2.61		12	2.12	17	12	4.98

(*1) Inductance is measured at 100 kHz.

(*2) Rated current defines actual value of DC current, when temperature rise of coil becomes 40 K.

Design and specifications are each subject to change without notice. Ask factory for the current technical specifications before purchase and/or use. Should a safety concern arise regarding this product, please be sure to contact us immediately.

Performance Characteristics (Reference)

Inductance vs DC Current

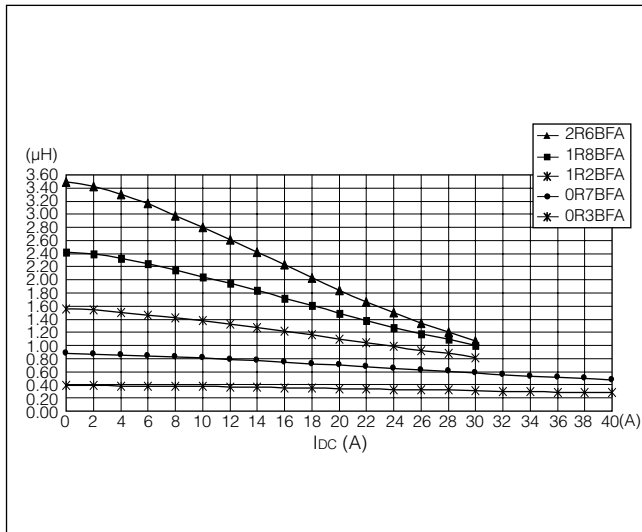

Case temperature vs DC Current

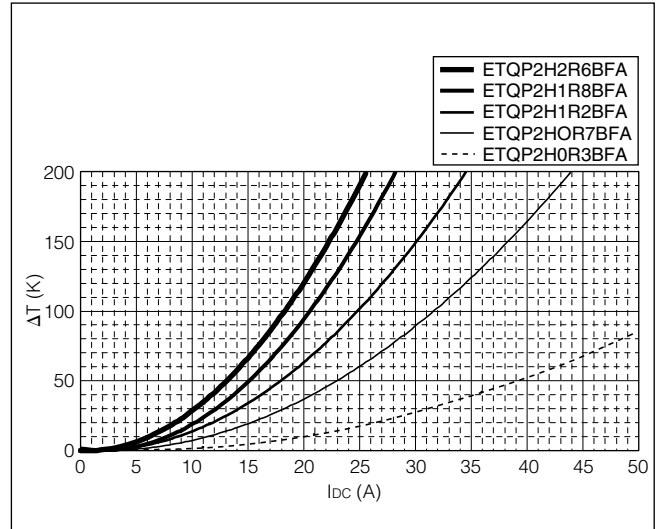

Dimensions in mm (not to scale)

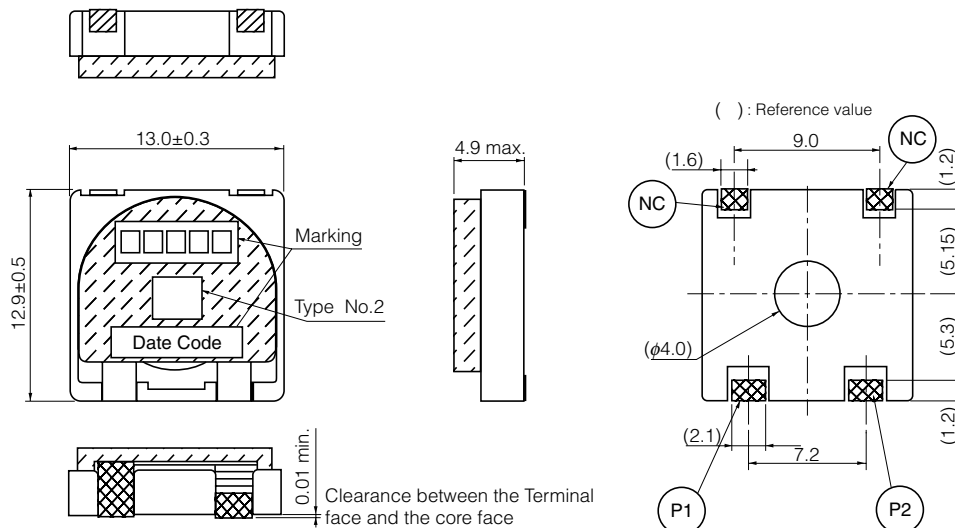

Connection

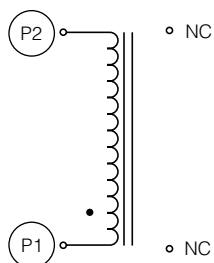

Recommended Land Pattern in mm (not to scale)

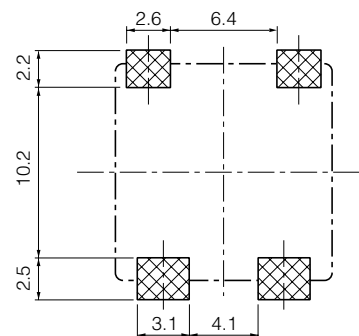

Packaging Methods, Soldering Conditions and Safety Precautions (Power Choke Coils for Consumer use)

Please see Data Files

Power Choke Coil

Series: **PCC-D126H (NX3)**

Low profile, High power, Low loss



■ Features

- High power, high inductance (No saturation performance limitation due to its metal dust core)
(27 A to 36 A/0.80 μ H to 0.45 μ H)
- Low loss due to low R_{DC} (using flat wire)
- Low buzz noise due to its gap-less structure
- Surface mount, low profile
(H)6.0 mm×(L)13.0 mm×(W)12.9 mm
- RoHS compliant

■ Recommended Applications

- DC-DC converter for CPU in PCs
- Thin on-board power supply modules for servers

■ Standard Packing Quantity

- 500 pcs./Reel

■ Explanation of Part Numbers

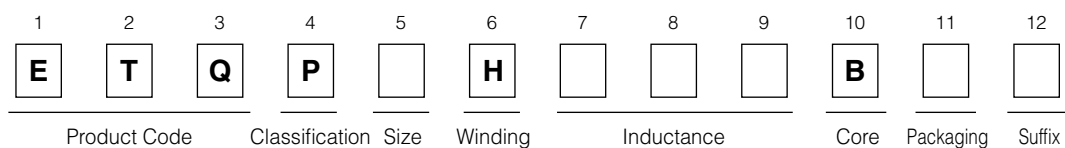

■ Standard Parts

Part No.	Inductance (at 20 °C)*1					Rated current (A)*2	DC resistance (at 20 °C) (m Ω) max.
	L1			L2 (Reference)			
	(μ H)	Tolerance (%)	Measurement current (A)	(μ H)	Measurement current (A)		
ETQP1H0R6BFA	0.60	±25	26	0.45	36	26	0.90
ETQP1H1R0BFA	1.00	±20	19	0.80	27	19	1.56

(*1) Inductance is measured at 100 kHz.

(*2) Rated current defines actual value of DC current, when temperature rise of coil becomes 40 K.

Design and specifications are each subject to change without notice. Ask factory for the current technical specifications before purchase and/or use. Should a safety concern arise regarding this product, please be sure to contact us immediately.

■ Performance Characteristics (Reference)

Inductance vs DC Current

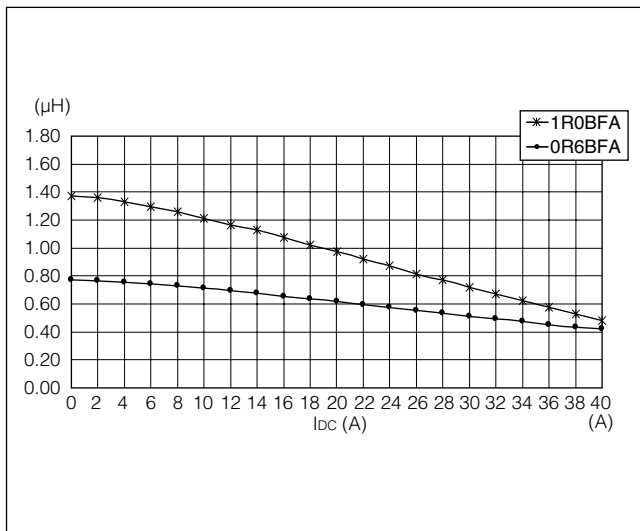

Case temperature vs DC Current

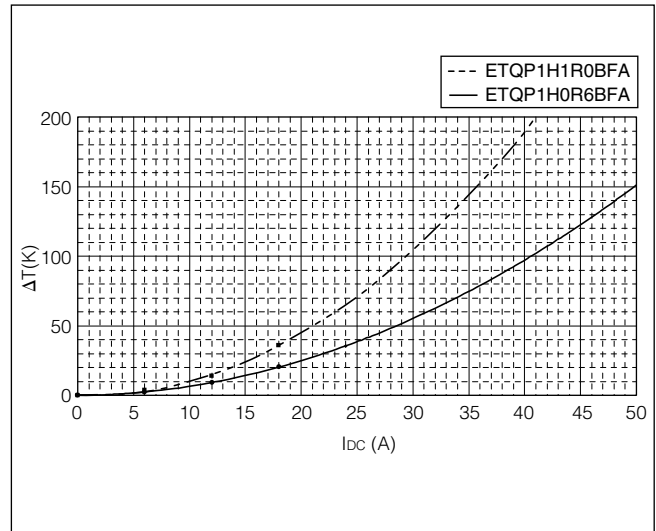

■ Dimensions in mm (not to scale)

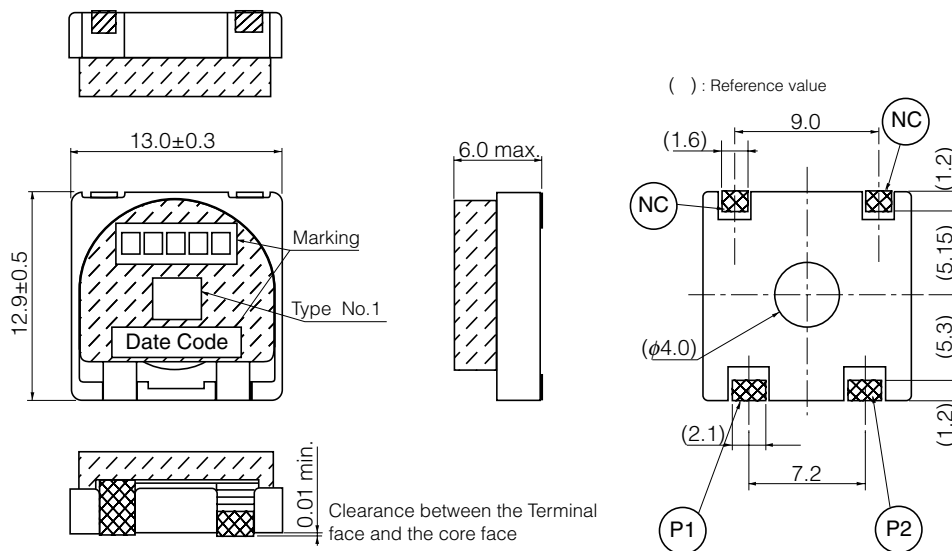

■ Connection

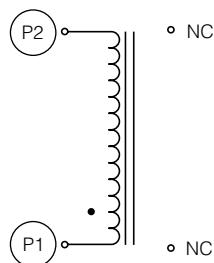

■ Recommended Land Pattern in mm (not to scale)

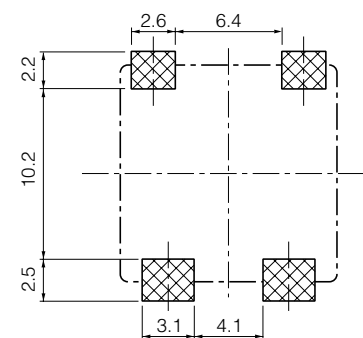

■ Packaging Methods, Soldering Conditions and Safety Precautions (Power Choke Coils for Consumer use)

Please see Data Files

Power Choke Coil

Series: **PCC-D126F (N6B)**

Low profile, High power, Low loss



■ Features

- High power, high inductance (No saturation performance limitation due to metal dust core)
(14 A to 27 A/2.96 μ H to 0.54 μ H)
- Low loss due to low R_{DC} (using flat wire)
- Low buzz noise due to its gap-less structure
- Surface mount, low profile
(H) 6.0 mm×(L)12.5 mm×(W)12.5 mm
- RoHS compliant

■ Recommended Applications

- DC-DC converters for CPU in PCs
- Thin on-board power supply modules for servers

■ Standard Packing Quantity

- 500 pcs./Reel

■ Explanation of Part Numbers

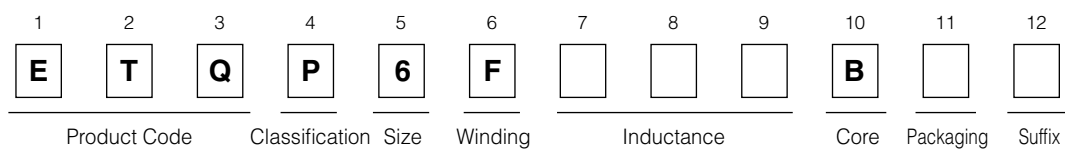

■ Standard Parts

Part No.	Inductance (at 20 °C)*1					Rated current (A)*2	DC resistance (at 20 °C) (m Ω) max.
	L1			L2 (Reference)			
	(μ H)	Tolerance (%)	Measurement current (A)	(μ H)	Measurement current (A)		
ETQP6F0R6BFA	0.58	±20	19	0.54	27	19	1.44
ETQP6F1R1BFA	1.06		16	0.99	22	16	2.24
ETQP6F1R8BFA	1.71		14	1.50	20	14	3.30
ETQP6F2R5BFA	2.45		12	2.17	17	12	4.92
ETQP6F3R4BFA	3.32		10	2.96	14	10	6.48

(*1) Inductance is measured at 100 kHz.

(*2) Rated current defines actual value of DC current, when temperature rise of coil becomes 40 K.

Design and specifications are each subject to change without notice. Ask factory for the current technical specifications before purchase and/or use. Should a safety concern arise regarding this product, please be sure to contact us immediately.

Performance Characteristics (Reference)

Inductance vs DC Current

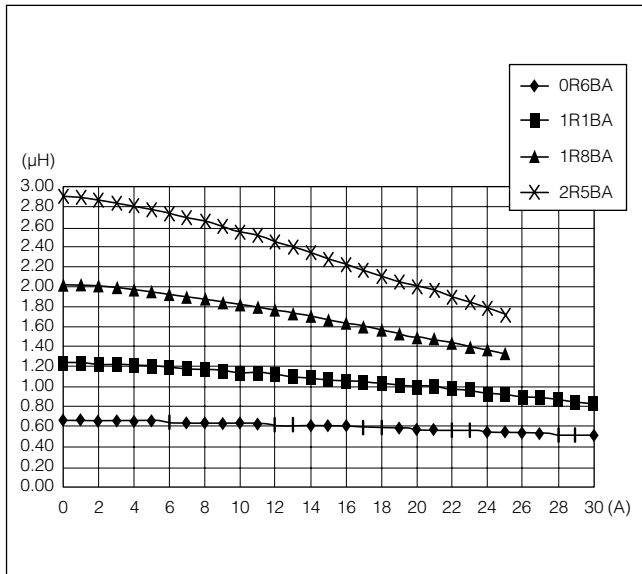

Case temperature vs DC Current

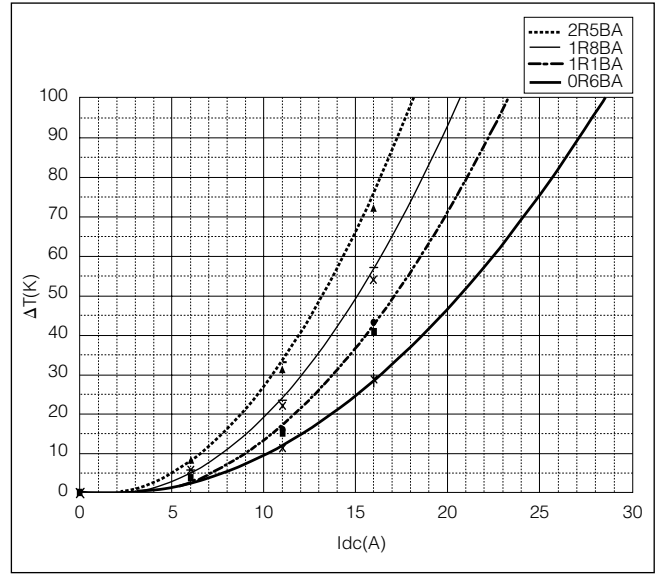

Dimensions in mm (not to scale)

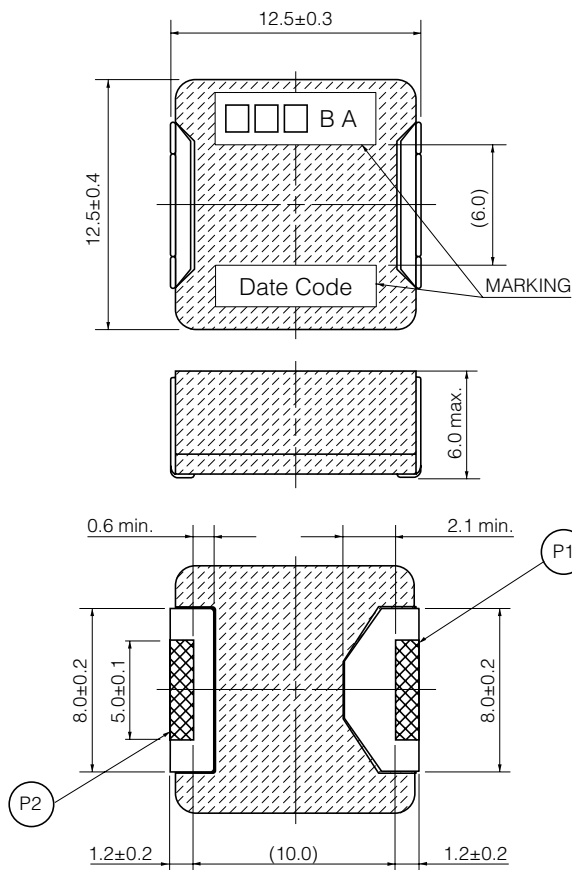

Recommended Land Pattern in mm (not to scale)

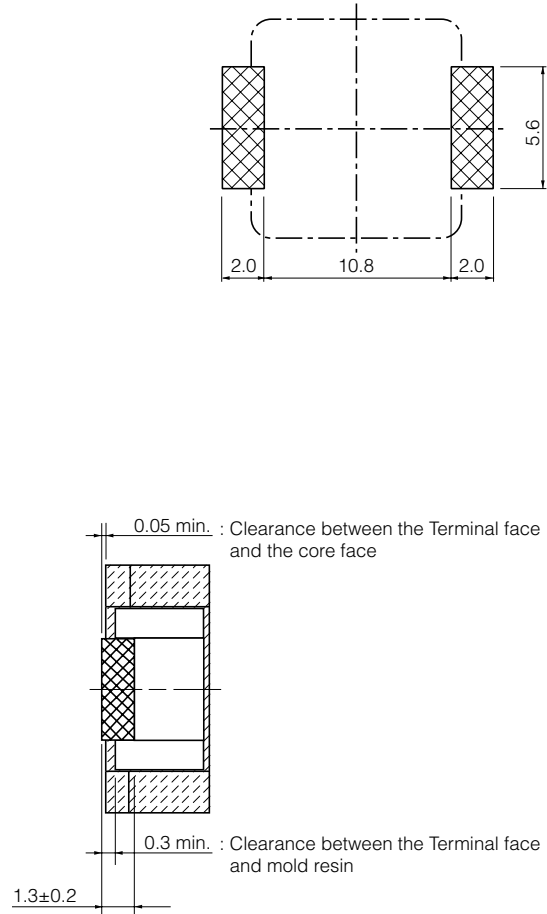

Packaging Methods, Soldering Conditions and Safety Precautions (Power Choke Coils for Consumer use)

Please see Data Files

Power Choke Coil

Series: **PCC-F126F (N6)**

Thin, compact and high power



■ Features

- High power (I_{sat} 20 A /100 °C)
- Thin profile (5.7 mm height)/SMD
- Low leakage flux
- RoHS compliant

■ Recommended Applications

- DC-DC converter for driving PCs at high speed
- On-board power supply module for DC-DC converters (10 to 40 W)

■ Standard Packing Quantity

- 500 pcs./Reel

■ Explanation of Part Numbers

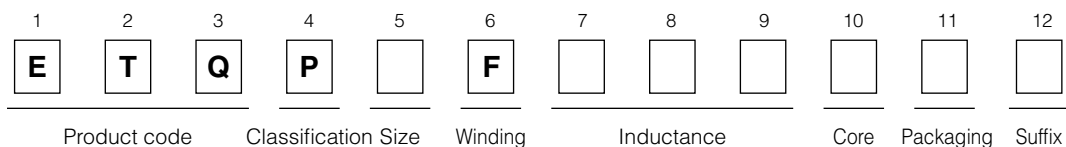

■ Standard Parts

Parts No.	Type	Initial inductance at 25 °C		Inductance at flat point at 25 °C		Saturation current		Heat current ΔT=40 °C	DC resistance at 20 °C
		L ₀ (μH)	Tol. (%)	L ₁ (μH)	Tol. (%)	I sat (A)	I sat (A)		
						min.	min.	I ₀ (A)	R _{DC} (mΩ)
ETQP6F1R2HFA	HL	2.3	±30	1.2	±30	14.3	11.7	14.2	2.24
ETQP6F2R0HFA		3.5		2.0		10.7	8.7	12.5	3.30
ETQP6F3R2HFA		4.8	±25	3.2	±25	8.6	7.1	10.8	4.92
ETQP6F4R6HFA		6.6		4.6		7.3	6.0	9.3	6.48
ETQP6F6R4HFA		8.3		6.4		6.2	5.2	7.9	8.64
ETQP6F8R2HFA		10.4		8.2		6.0	5.0	7.2	10.90
ETQP6F102HFA		12.5		10.2		4.7	4.0	6.5	13.30
ETQP6F1R0SFA	SP	1.9	±30	1.0	±30	19.4	15.4	14.2	2.24
ETQP6F1R6SFA		2.8		1.6		14.9	12.2	12.5	3.30
ETQP6F2R5SFA		3.6		2.5		11.3	9.3	10.8	4.92
ETQP6F3R5SFA		4.9		3.5		9.5	8.0	9.3	6.48
ETQP6F0R8LFA	LB	1.8	±30	0.8	±30	25.2	20.0	14.2	2.24
ETQP6F1R3LFA		2.5		1.3		18.6	15.8	12.5	3.30
ETQP6F2R0LFA		3.1		2.0		15.1	12.1	10.8	4.92
ETQP6F2R9LFA		4.1		2.9		12.0	10.0	9.3	6.48
ETQP6F4R1LFA		5.0		4.1		10.8	8.7	7.9	8.64

(Note1) Inductance is measured at 100 kHz

(Note2) For definitions of L₀ & L₁ please see the next page

(Note3) Saturation current (I_{sat}) is the current value that inductance (L₁) decreases to 80 % of initial value.

(Note4) Heat current (I₀) is the actual value of the current at which the temperature rise of the coil becomes 40 dc from its initial (ambient temperature) value. The case temperature of the power choke coil is determined by the ambient temperature plus the heat generated by the operating current.

■ Figure 1: L_0, L_1 : Definition

DC Bias Characteristic

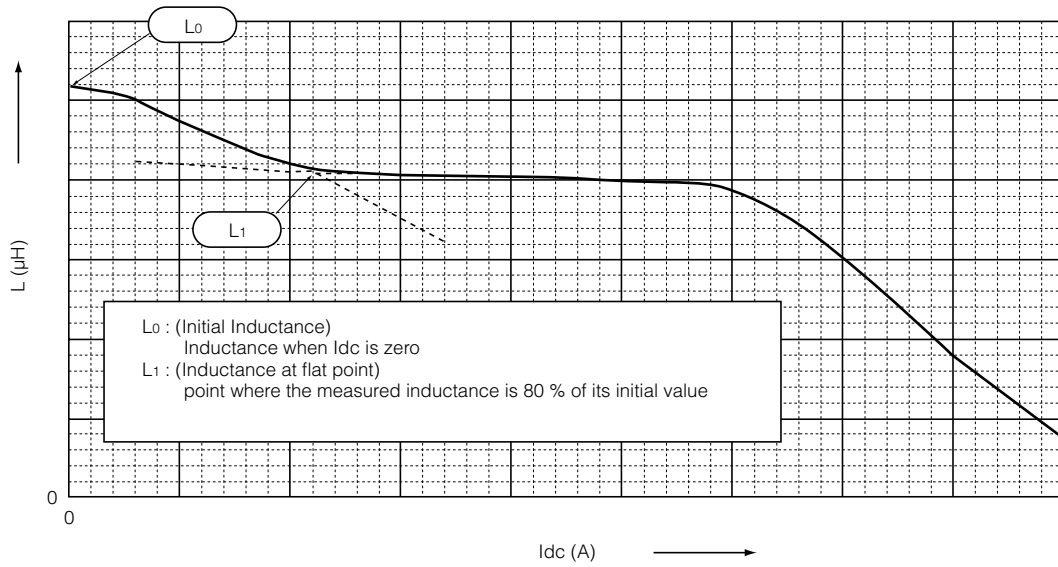

■ Figure 2: Dimensions in mm (not to scale)

■ Recommended Land Pattern in mm (not to scale)

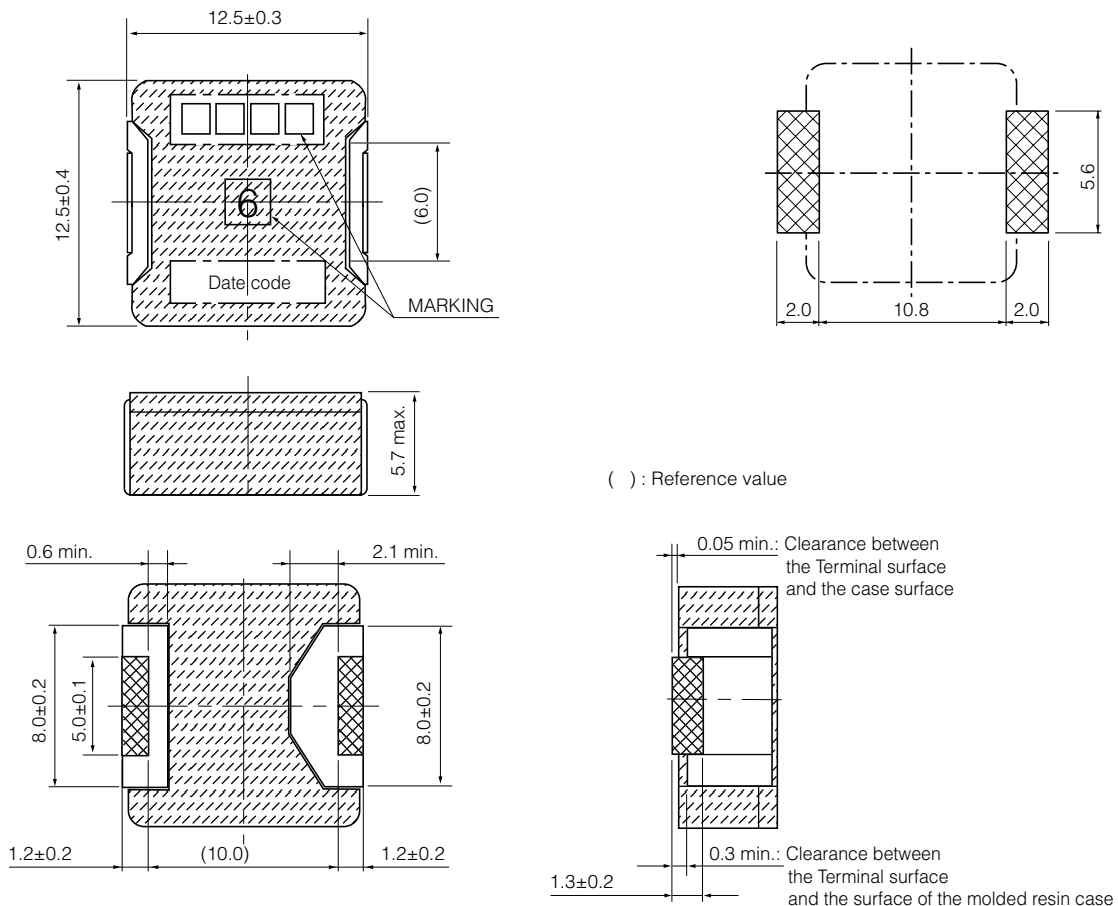

■ Packaging Methods, Soldering Conditions and Safety Precautions (Power Choke Coils for Consumer use)

Please see Data Files

■ Packaging Methods (Taping)

● Embossed Carrier Tape Dimensions in mm (not to scale)

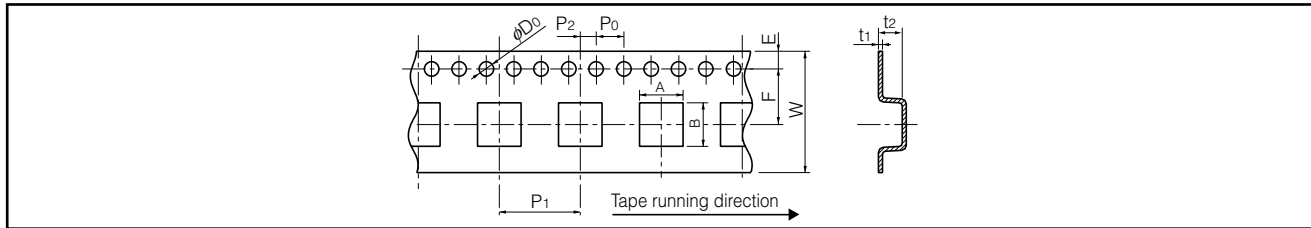

Power Choke Coils for high reliability use

Series	A	B	W	E	F	P ₁	P ₂	P ₀	φD ₀	t ₁	t ₂				
PCC-M0530M	5.6	6.1	16.0	1.75	7.5	12.0	2.0	4.0	1.5	0.4	3.3				
PCC-M0540M											4.3				
PCC-M0630M	7.1	6.6									7.5	11.5	16.0	0.5	3.3
PCC-M0645M															5.0
PCC-M0754M	8.1	7.6									24.0	11.5	16.0	0.5	6.0
PCC-M0854M/M0850M	9.1	8.6													6.3
PCC-M1054M/M1050M	10.7	11.9	24.0	11.5	16.0	0.5	6.3								
PCC-M1050ML/M1060ML															

Power Choke Coils for consumer use

Series	A	B	W	E	F	P ₁	P ₂	P ₀	φD ₀	t ₁	t ₂	
PCC-M0512W	5.6	5.85	12.0	1.75	5.5	8.0	2.0	4.0	1.5	0.4	1.4	
PCC-M0630L	7.1	8.0			7.5						12.0	3.2
PCC-M0630W	7.2	7.5	7.5		12.0	0.4					3.3	
PCC-M0730L	7.6	8.9									4.2	
PCC-M074L	7.6	8.9	24.0		11.5	16.0					0.4	4.3
PCC-M104W	10.6	11.0										5.2
PCC-M104L	10.6	11.8	13.1	14.8	13.5	13.5	13.0	5.3				
PCC-M125L	13.1	14.8						5.2				
PCC-D124H	13.5	13.5	24.0	11.5	16.0	0.4	6.2					
PCC-D125H								5.2				
PCC-D126H	13.0	13.0	24.0	11.5	16.0	0.4	6.0					
PCC-D126F								6.0				
PCC-F126F	13.0	13.0	24.0	11.5	16.0	0.4	6.0					

● Taping Reel Dimensions in mm (not to scale)

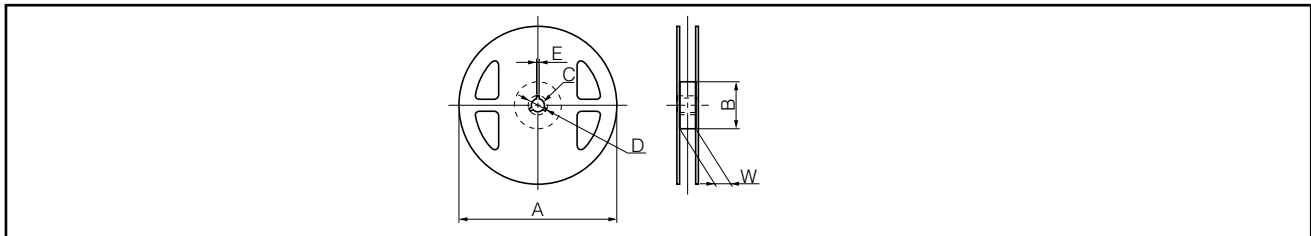

Power Choke Coils for high reliability use

Series	A	B	C	D	E	W
PCC-M0530M/M0540M	330	100	13	21	2	17.5
PCC-M0630M/M0645M						
PCC-M0754M						
PCC-M0854M/M0850M						
PCC-M1054M/M1050M	330	100	13	21	2	25.5
PCC-M1050ML/M1060ML						

Power Choke Coils for consumer use

Series	A	B	C	D	E	W
PCC-M0512W	330	(80)	13	21	2	13.5
PCC-M0630L/M0630W						17.5
PCC-M104W						25.5
PCC-M0730L/M074L	380	80	13	21	2	17.5
PCC-M104L						
PCC-M125L/D124H/D125H/ D126H/D126F/F126F						25.4

Design and specifications are each subject to change without notice. Ask factory for the current technical specifications before purchase and/or use. Should a safety concern arise regarding this product, please be sure to contact us immediately.

■ Component Placement (Taping)

● Power Choke Coils for high reliability use

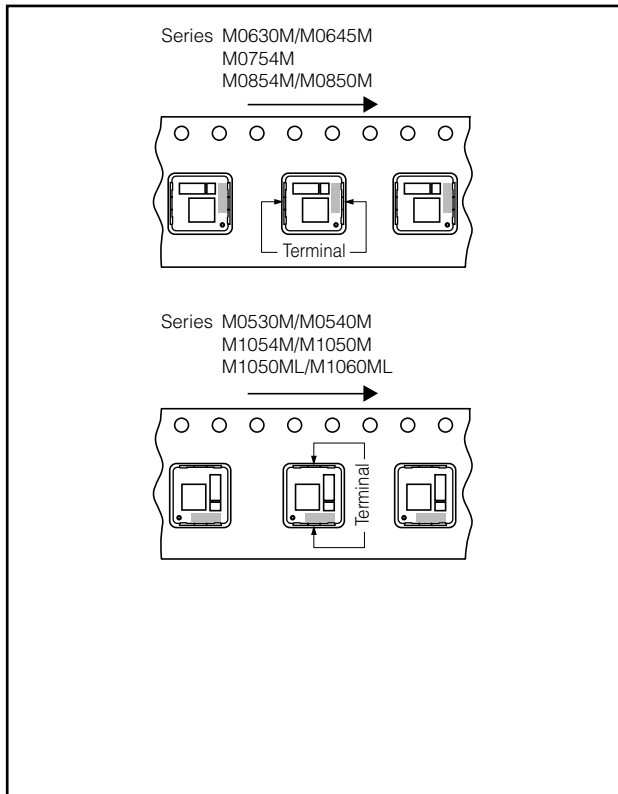

● Power Choke Coils for consumer use

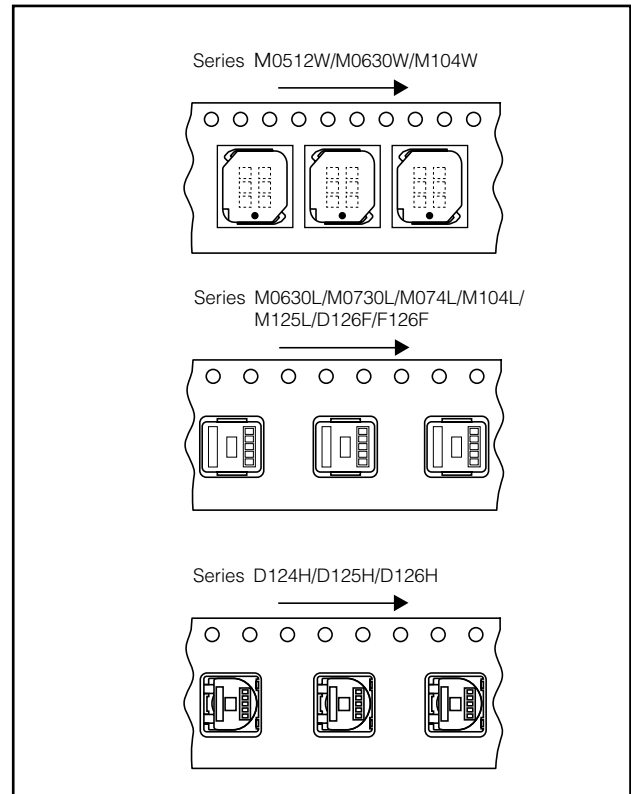

■ Standard Packing Quantity/Reel

● Power Choke Coils for high reliability use

Series	Minimum Quantity / Packing Unit	Quantity per reel
PCC-M0530M/M0540M	2000 pcs. / box (2 reel)	1000 pcs.
PCC-M0630M		
PCC-M0645M	1000 pcs. / box (2 reel)	500 pcs.
PCC-M0754M		
PCC-M0854M/M0850M		
PCC-M1054M/M1050M		
PCC-M1050ML/M1060ML		

● Power Choke Coils for consumer use

Series	Minimum Quantity / Packing Unit	Quantity per reel
PCC-M0512W	6000 pcs. / box (2 reel)	3000 pcs.
PCC-M0730L	3000 pcs. / box (2 reel)	1500 pcs.
PCC-M074L		
PCC-M0630L	2000 pcs. / box (2 reel)	1000 pcs.
PCC-M0630W		
PCC-M104L		
PCC-M104W	1000 pcs. / box (2 reel)	500 pcs.
PCC-M125L		
PCC-D124H		
PCC-D125H		
PCC-D126H		
PCC-D126F		
PCC-F126F		

Design and specifications are each subject to change without notice. Ask factory for the current technical specifications before purchase and/or use. Should a safety concern arise regarding this product, please be sure to contact us immediately.

Soldering Conditions

■ Reflow soldering conditions

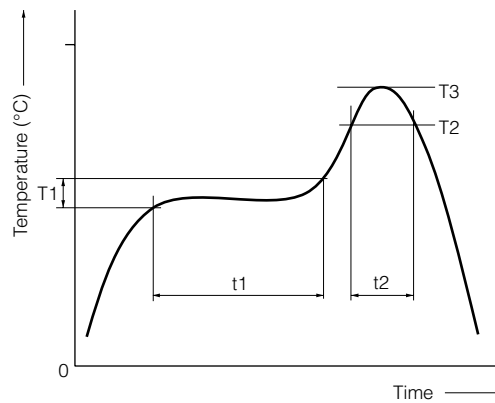

● Pb free solder recommended temperature profile
Power Choke Coils for high reliability use

Series	Preheat		Soldering		Peak Temperature		Time of Reflow
	T1 [°C]	t1 [s]	T2 [°C]	t2 [s]	T3	T3 Limit	
PCC-D1413H PCC-M0530M/M0540M PCC-M0630M/M0645M PCC-M0754M PCC-M0854M/M0850M PCC-M1054M/M1050M PCC-M1050ML/M1060ML	150 to 170	60 to 120	230 °C	30 to 40	250 °C, 5 s	260 °C, 10 s	2 times max.

Power Choke Coils for consumer use

Series	Preheat		Soldering		Peak Temperature		Time of Reflow
	T1 [°C]	t1 [s]	T2 [°C]	t2 [s]	T3	T3 Limit	
PCC-M0512W PCC-M0630L PCC-M0630W PCC-M0730L PCC-M074L PCC-M104L PCC-M104W PCC-M125L PCC-D124H PCC-D125H PCC-D126H PCC-D126F PCC-F126F	150 to 170	60 to 120	230 °C	30 to 40	250 °C, 5 s	260 °C, 10 s	2 times max.

Design and specifications are each subject to change without notice. Ask factory for the current technical specifications before purchase and/or use.
Should a safety concern arise regarding this product, please be sure to contact us immediately.

⚠ Safety Precautions

(Common precautions for Power Choke Coils for consumer use)

- When using our products, no matter what sort of equipment they might be used for, be sure to make a written agreement on the specifications with us in advance. The design and specifications in this catalog are subject to change without prior notice.
- Do not use the products beyond the specifications described in this catalog.
- This catalog explains the quality and performance of the products as individual components. Before use, check and evaluate their operations when installed in your products.
- Install the following systems for a failsafe design to ensure safety if these products are to be used in equipment where a defect in these products may cause the loss of human life or other significant damage, such as damage to vehicles (automobile, train, vessel), traffic lights, medical equipment, aerospace equipment, electric heating appliances, combustion/gas equipment, rotating equipment, and disaster/crime prevention equipment.
 - * Systems equipped with a protection circuit and a protection device
 - * Systems equipped with a redundant circuit or other system to prevent an unsafe status in the event of a single fault

⚠ Precautions for use

1. Provision to abnormal condition

This power choke coil itself does not have any protective function in abnormal condition such as overload, short-circuit and open-circuit conditions, etc.

Therefore, it shall be confirmed as the end product that there is no risk of smoking, fire, dielectric withstand voltage, insulation resistance, etc. in abnormal conditions to provide protective devices and/or protection circuit in the end product.

2. Temperature rise

Temperature rise of power choke coil depends on the installation condition in end products. It shall be confirmed in the actual end product that temperature rise of power choke coil is in the limit of specified temperature class.

3. Dielectric strength

Dielectric withstanding test with higher voltage than specific value will damage Insulating material and shorten its life.

4. Water

This Power choke coil must not be used in wet condition by water, coffee or any liquid because insulation strength becomes very low in the condition.

5. Potting

If this power choke coil is potted in some compound, coating material of magnet wire might be occasionally damaged. Please ask us if you intend to pot this power choke coil.

6. Detergent

Please consult our company in case of this because the confirmation of reliability etc. is needed when the washing is used for the power choke coil.

7. Storage temperature

-5 °C to +35 °C

8. Operating temperature

Minimum temperature : -40 °C(Ambient temperature of the power choke coil)

Maximum temperature : 130 °C(Ambient temperature of the power choke coil plus the temperature rise)

100 °C(Only series : PCC-F126F(N6))

9. Model

When this power choke coil was used in a similar or new product to the original one, sometimes it might be unable to satisfy the specifications due to difference of condition of usage.

Please ask us if you would use this power choke coil in the manner such as above.

10. Drop

If the power choke coil suffered mechanical stress such as drop, characteristics may become poor (due to damage on coil bobbin, etc.). Never use such stressed power choke coil.

<Package markings>

Package markings include the product number, quantity, and country of origin.

In principle, the country of origin should be indicated in English.

Choke Coils

Series: **Pin terminal**
 Type: **09D, 11D, 12D, 16B, 18B, 10E, 12E, 15E, 18E**

Pin terminal inductors featuring small size and high performance

■ Features

- High - μ and High Bm cores
- Wide inductor range
- Magnetic shield type (E Type)
- RoHS compliant

■ Recommended Applications

- CTV, VCR, Audio, PC, Fax machines, PDP, Home appliance



■ Explanation of Part Numbers

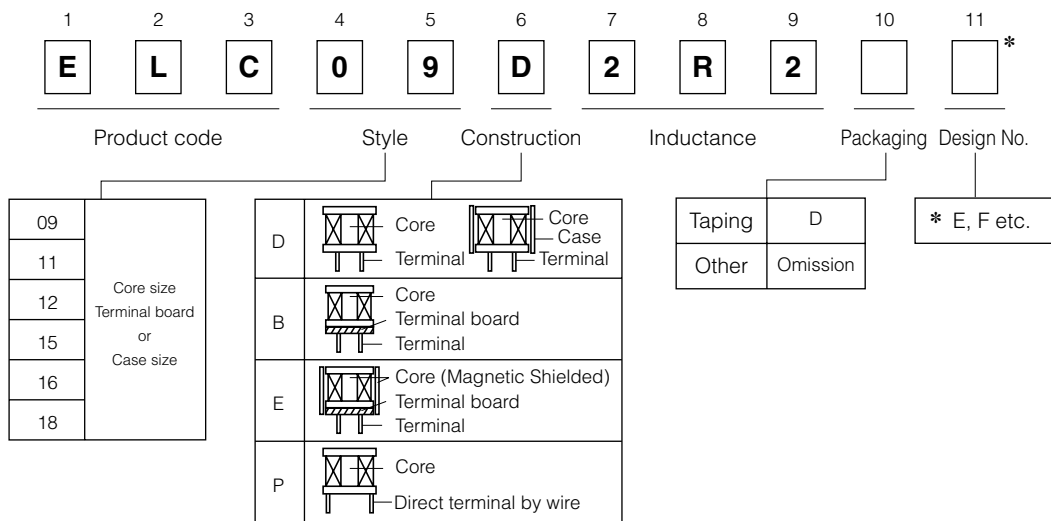



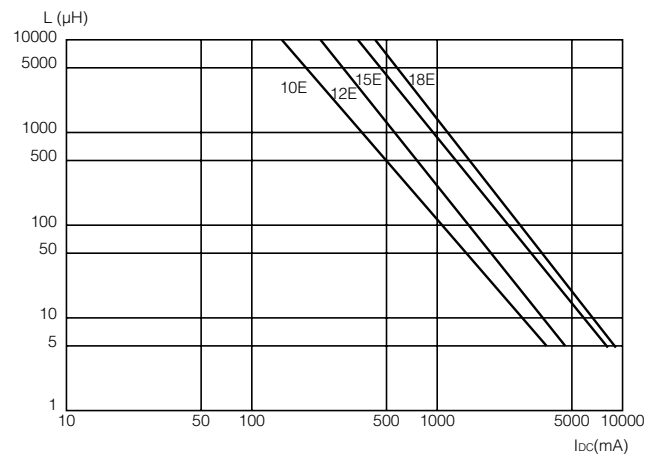
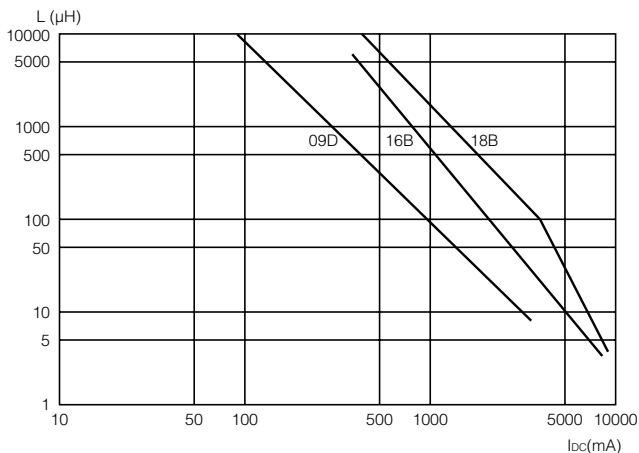





■ Available I-L Characteristics



Design and specifications are each subject to change without notice. Ask factory for the current technical specifications before purchase and/or use. Should a safety concern arise regarding this product, please be sure to contact us immediately.

■ Performance Characteristics by Series

	Type	Construction	External Dimensions D×H (mm)	Inductance (μH)						Current I _{DC} (A)
				0.1	1.0	10	100	1000	10000	
Regular	09D *		φ9.5×8.9 (with case)			2.2			10000	0.08 to 3.5
	11D *		φ11.5×13.9 (with case)			2.2			10000	0.16 to 5.3
	12D		φ12.5×16.5				100		10000	0.27 to 1.9
	16B		φ16.0×23.0			3.3			10000	0.26 to 8.5
	18B		φ20.0×27.0			3.3			10000	0.36 to 8.5
Shield	10E-L		φ10.0×13.0			3.9			8200	0.10 to 2.9
	12E-L		φ13.0×18.5			4.7			10000	0.13 to 4.4
	15E-L		φ16.0×22.0 (3 pin terminal)			5.6			10000	0.30 to 5.4
	18E-L		φ19.0×25.1 (4 pin terminal)			5.6			10000	0.33 to 5.9

*: Taping Available

Examples Type 09D

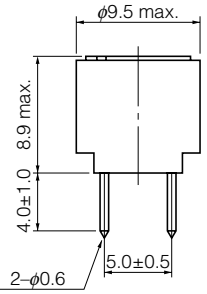
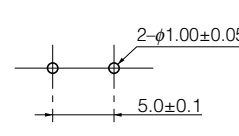
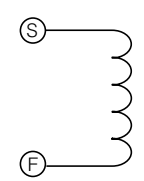
	Part No.	Inductance (μH)	Tolerance (%)	Test Freq. (kHz)	R _{DC} (Ω) [at 20 °C] **(Tol.±30 %) (Tol.±20 %)	*I _{DC} . [at 20 °C] (A)max.	
<p>[Dimensions in mm] (not to scale)</p> 	ELC09D2R2□F	2.2	±20	10	0.012	3.50	
	ELC09D2R7□F	2.7			0.013	3.30	
	ELC09D3R3□F	3.3			0.015	3.20	
	ELC09D3R9□F	3.9			0.016	3.10	
	ELC09D4R7□F	4.7			0.018	3.00	
	ELC09D5R6□F	5.6			0.019	2.90	
	ELC09D6R8□F	6.8			0.021	2.80	
	ELC09D8R2□F	8.2			0.024	2.60	
	ELC09D100□F	10.0			0.027	2.50	
	ELC09D120□F	12.0			0.031	2.30	
	ELC09D150□F	15.0			0.035	2.10	
	ELC09D180□F	18.0			0.038	2.00	
	ELC09D220□F	22.0			0.051	1.80	
	ELC09D270□F	27.0			0.058	1.60	
	ELC09D330□F	33.0			0.081	1.40	
	<p>Recommended PWB piercing plan</p> 	ELC09D390□F	39.0		±10	0.087	1.30
		ELC09D470□F	47.0			0.110	1.20
		ELC09D560□F	56.0			0.130	1.10
		ELC09D680□F	68.0			0.140	1.00
		ELC09D820□F	82.0			0.160	0.90
		ELC09D101□F	100.0			0.200	0.82
		ELC09D121□F	120.0			0.250	0.77
		ELC09D151□F	150.0			0.320	0.74
		ELC09D181□F	180.0			0.360	0.61
		ELC09D221□F	220.0			0.410	0.58
ELC09D271□F		270.0	0.500			0.52	
ELC09D331□F		330.0	0.650			0.49	
ELC09D391□F		390.0	0.860			0.46	
ELC09D471□F		470.0	0.980			0.39	
<p>Connection Schematic</p> 		ELC09D561□F	560.0			1.100	0.36
	ELC09D681□F	680.0	1.400	0.34			
	ELC09D821□F	820.0	1.600	0.30			
	ELC09D102□F	1000.0	2.100	0.28			
	ELC09D122□F	1200.0	2.400	0.23			
	ELC09D152□F	1500.0	2.800	0.21			
	ELC09D182□F	1800.0	3.800	0.19			
	ELC09D222□F	2200.0	4.400	0.17			
	ELC09D272□F	2700.0	6.100	0.16			
	ELC09D332□F	3300.0	7.000	0.14			
ELC09D392□F	3900.0	8.000	0.13				
ELC09D472□F	4700.0	11.200	0.12				
ELC09D562□F	5600.0	12.600	0.11				
ELC09D682□F	6800.0	14.400	0.10				
ELC09D822□F	8200.0	16.600	0.09				
ELC09D103□F	10000.0	18.800	0.08				

* Allowable DC Current: Smaller current value either when the inductance is -10 % or when the case temperature has risen 45 °C.

Design and specifications are each subject to change without notice. Ask factory for the current technical specifications before purchase and/or use. Should a safety concern arise regarding this product, please be sure to contact us immediately.

Examples Type 11D

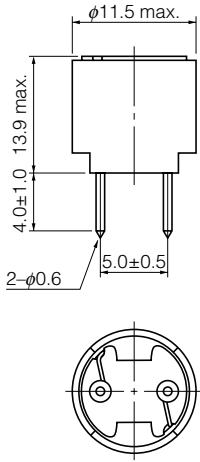
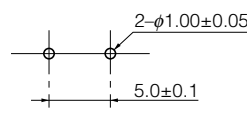
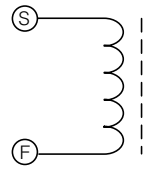
	Part No.	Inductance (μH)	Tolerance (%)	Test Freq. (kHz)	R _{DC} (Ω) [at 20 °C] (Tol.±20 %)	*I _{DC} . [at 20 °C] (A)max.			
<p>[Dimensions in mm] (not to scale)</p> 	ELC11D2R2□F	2.2	±20	10	0.013	5.30			
	ELC11D2R7□F	2.7			0.014	5.10			
	ELC11D3R3□F	3.3			0.015	4.90			
	ELC11D3R9□F	3.9			0.016	4.80			
	ELC11D4R7□F	4.7			0.018	4.70			
	ELC11D5R6□F	5.6			0.020	4.60			
	ELC11D6R8□F	6.8			0.022	4.40			
	ELC11D8R2□F	8.2			0.024	3.90			
	ELC11D100□F	10.0			0.029	3.50			
	ELC11D120□F	12.0			0.030	3.40			
	ELC11D150□F	15.0			0.033	3.30			
	ELC11D180□F	18.0			0.037	3.10			
	ELC11D220□F	22.0			0.040	2.80			
	ELC11D270□F	27.0			0.048	2.70			
	ELC11D330□F	33.0			0.051	2.60			
	ELC11D390□F	39.0			0.057	2.50			
	ELC11D470□F	47.0			0.063	2.30			
	ELC11D560□F	56.0			0.071	2.10			
	ELC11D680□F	68.0			0.082	2.00			
	ELC11D820□F	82.0			0.090	1.90			
	<p>Recommended PWB piercing plan</p> 	ELC11D101□F			100.0	±10	10	0.120	1.80
		ELC11D121□F			120.0			0.160	1.60
		ELC11D151□F			150.0			0.180	1.40
		ELC11D181□F			180.0			0.200	1.30
		ELC11D221□F			220.0			0.230	1.20
ELC11D271□F		270.0	0.320	1.10					
ELC11D331□F		330.0	0.350	1.00					
ELC11D391□F		390.0	0.400	0.95					
ELC11D471□F		470.0	0.490	0.82					
ELC11D561□F		560.0	0.620	0.73					
ELC11D681□F		680.0	0.780	0.64					
ELC11D821□F		820.0	0.870	0.62					
ELC11D102□F		1000.0	1.100	0.57					
ELC11D122□F		1200.0	1.200	0.52					
<p>Connection Schematic</p> 		ELC11D152□F	1500.0					1.700	0.43
	ELC11D182□F	1800.0			2.000	0.40			
	ELC11D222□F	2200.0			2.300	0.38			
	ELC11D272□F	2700.0			2.800	0.34			
	ELC11D332□F	3300.0			3.600	0.31			
	ELC11D392□F	3900.0			4.500	0.29			
	ELC11D472□F	4700.0			5.200	0.26			
	ELC11D562□F	5600.0			6.900	0.23			
	ELC11D682□F	6800.0			7.800	0.21			
	ELC11D822□F	8200.0			10.600	0.18			
ELC11D103□F	10000.0			11.800	0.16				

* Allowable DC Current: Smaller current value either when the inductance is -10 % or when the case temperature has risen 45 °C.

Design and specifications are each subject to change without notice. Ask factory for the current technical specifications before purchase and/or use. Should a safety concern arise regarding this product, please be sure to contact us immediately.

■ Examples Type 12D

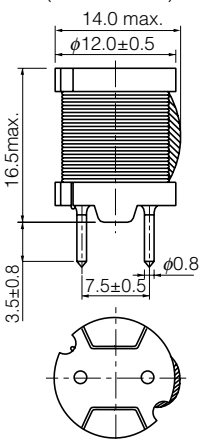
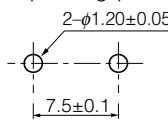
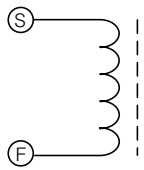
	Part No.	Inductance (μH)	Tolerance (%)	Test Freq. (kHz)	R _{DC} (Ω) [at 20 °C] (Tol.±20 %)	*I _{DC} . [at 20 °C] (A)max.
<p>[Dimensions in mm] (not to scale)</p>  <p>Recommended PWB piercing plan</p>  <p>Connection Schematic</p> 	ELC12D101E	100	±10	10	0.150	1.90
	ELC12D121E	120			0.170	1.78
	ELC12D151E	150			0.190	1.67
	ELC12D181E	180			0.210	1.58
	ELC12D221E	220			0.230	1.55
	ELC12D271E	270			0.270	1.44
	ELC12D331E	330			0.300	1.34
	ELC12D391E	390			0.330	1.32
	ELC12D471E	470			0.380	1.25
	ELC12D561E	560			0.420	1.15
	ELC12D681E	680			0.460	0.98
	ELC12D821E	820			0.650	0.94
	ELC12D102E	1000			0.720	0.87
	ELC12D122E	1200			0.830	0.86
	ELC12D152E	1500			1.270	0.64
	ELC12D182E	1800			1.330	0.63
	ELC12D222E	2200			1.500	0.60
	ELC12D272E	2700			1.890	0.54
	ELC12D332E	3300			2.370	0.48
	ELC12D392E	3900			2.830	0.45
ELC12D472E	4700	3.190	0.41			
ELC12D562E	5600	4.080	0.34			
ELC12D682E	6800	5.740	0.29			
ELC12D822E	8200	6.340	0.28			
ELC12D103E	10000	7.200	0.27			

* Allowable DC Current: Smaller current value either when the inductance is -10 % or when the case temperature has risen 45 °C.

Examples Type 16B

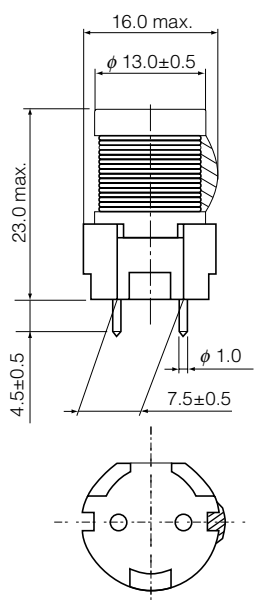
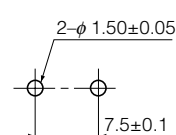
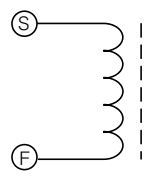
	Part No.	Inductance (μH)	Tolerance (%)	Test Freq. (kHz)	R _{DC} (Ω) [at 20 °C] **(Tol.±30 %) (Tol.±20 %)	*I _{DC} . [at 20 °C] (A)max.
<p>[Dimensions in mm] (not to scale)</p>  <p>Recommended PWB piercing plan</p>  <p>Connection Schematic</p> 	ELC16B3R3L	3.3	±25	10	**0.012	8.50
	ELC16B3R9L	3.9			**0.013	8.00
	ELC16B4R7L	4.7			**0.015	7.80
	ELC16B5R6L	5.6	±20		**0.016	7.40
	ELC16B6R8L	6.8			0.018	6.70
	ELC16B8R2L	8.2			0.019	6.10
	ELC16B100L	10.0			0.022	5.60
	ELC16B120L	12.0			0.023	5.50
	ELC16B150L	15.0			0.026	5.40
	ELC16B180L	18.0			0.028	5.10
	ELC16B220L	22.0			0.031	4.60
	ELC16B270L	27.0			0.034	4.30
	ELC16B330L	33.0			0.039	4.00
	ELC16B390L	39.0	0.042		3.90	
	ELC16B470L	47.0	0.045		3.80	
	ELC16B560L	56.0	0.051		3.40	
	ELC16B680L	68.0	0.057		3.20	
	ELC16B820L	82.0	0.064		3.00	
	ELC16B101L	100.0	0.072		2.60	
	ELC16B121L	120.0	0.080		2.50	
	ELC16B151L	150.0	0.103		2.20	
	ELC16B181L	180.0	0.115		2.10	
	ELC16B221L	220.0	0.130		1.90	
	ELC16B271L	270.0	0.170		1.60	
	ELC16B331L	330.0	0.200		1.50	
	ELC16B391L	390.0	0.250		1.30	
	ELC16B471L	470.0	0.280		1.20	
	ELC16B561L	560.0	0.380		1.10	
	ELC16B681L	680.0	0.430		1.00	
	ELC16B821L	820.0	0.580		0.88	
	ELC16B102L	1000.0	0.660		0.85	
	ELC16B122L	1200.0	0.740		0.82	
	ELC16B152L	1500.0	0.870		0.74	
ELC16B182L	1800.0	1.220	0.60			
ELC16B222L	2200.0	1.380	0.57			
ELC16B272L	2700.0	1.570	0.54			
ELC16B332L	3300.0	2.000	0.47			
ELC16B392L	3900.0	2.400	0.42			
ELC16B472L	4700.0	3.300	0.36			
ELC16B562L	5600.0	3.700	0.34			
ELC16B682L	6800.0	4.200	0.32			
ELC16B822L	8200.0	5.600	0.28			
ELC16B103L	10000.0	6.400	0.26			

* Allowable DC Current: Smaller current value either when the inductance is -10 % or when the case temperature has risen 45 °C.

Design and specifications are each subject to change without notice. Ask factory for the current technical specifications before purchase and/or use.
Should a safety concern arise regarding this product, please be sure to contact us immediately.

Examples Type 18B

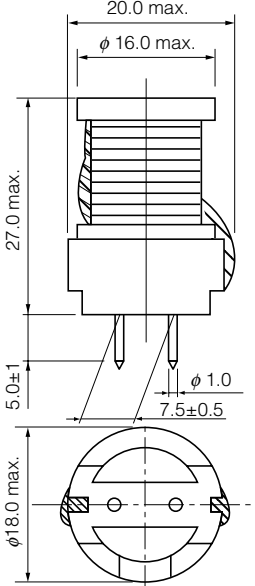
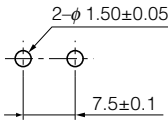
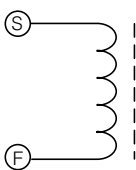
	Part No.	Inductance (μH)	Tolerance (%)	Test Freq. (kHz)	R _{DC} (Ω) [at 20 °C] (Tol.±20 %)	*I _{DC} . [at 20 °C] (A)max.
<p>[Dimensions in mm] (not to scale)</p>  <p>Recommended PWB piercing plan</p>  <p>Connection Schematic</p> 	ELC18B3R3L	3.3	±20	10	0.010	8.50
	ELC18B3R9L	3.9			0.011	8.00
	ELC18B4R7L	4.7			0.012	7.80
	ELC18B5R6L	5.6			0.013	7.40
	ELC18B6R8L	6.8			0.015	6.80
	ELC18B8R2L	8.2			0.016	6.60
	ELC18B100L	10.0			0.017	6.50
	ELC18B120L	12.0			0.018	6.00
	ELC18B150L	15.0			0.021	5.90
	ELC18B180L	18.0			0.022	5.60
	ELC18B220L	22.0			0.025	5.40
	ELC18B270L	27.0			0.028	4.80
	ELC18B330L	33.0			0.030	4.60
	ELC18B390L	39.0			0.033	4.40
	ELC18B470L	47.0			0.037	4.30
	ELC18B560L	56.0	0.040		4.20	
	ELC18B680L	68.0	0.046		4.00	
	ELC18B820L	82.0	0.051		3.70	
	ELC18B101L	100.0	0.057		3.20	
	ELC18B121L	120.0	0.065		3.00	
	ELC18B151L	150.0	0.072		2.70	
	ELC18B181L	180.0	0.082		2.60	
	ELC18B221L	220.0	0.090		2.40	
	ELC18B271L	270.0	0.110		2.20	
	ELC18B331L	330.0	0.130		1.90	
	ELC18B391L	390.0	0.150		1.80	
	ELC18B471L	470.0	0.210		1.60	
	ELC18B561L	560.0	0.230		1.50	
	ELC18B681L	680.0	0.260		1.40	
	ELC18B821L	820.0	0.340		1.30	
	ELC18B102L	1000.0	0.390		1.10	
	ELC18B122L	1200.0	0.440		1.00	
	ELC18B152L	1500.0	0.580		0.85	
ELC18B182L	1800.0	0.650	0.84			
ELC18B222L	2200.0	0.880	0.75			
ELC18B272L	2700.0	1.200	0.68			
ELC18B332L	3300.0	1.400	0.60			
ELC18B392L	3900.0	1.500	0.57			
ELC18B472L	4700.0	1.700	0.55			
ELC18B562L	5600.0	2.200	0.46			
ELC18B682L	6800.0	2.800	0.45			
ELC18B822L	8200.0	3.100	0.41			
ELC18B103L	10000.0	3.900	0.36			
			±10			

* Allowable DC Current: Smaller current value either when the inductance is -10 % or when the case temperature has risen 45 °C.

Design and specifications are each subject to change without notice. Ask factory for the current technical specifications before purchase and/or use. Should a safety concern arise regarding this product, please be sure to contact us immediately.

Examples Type 10E-L

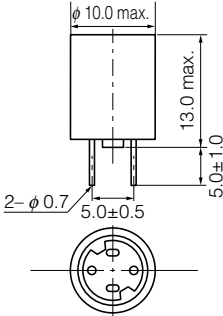
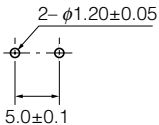
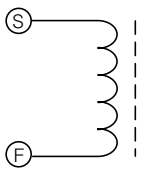
	Part No.	Inductance (μH)	Tolerance (%)	Test Freq. (kHz)	R _{DC} (Ω) [at 20 °C] (Tol.±20 %)	*I _{DC} . [at 20 °C] (A)max.	
[Dimensions in mm] (not to scale) 	ELC10E3R9L	3.9	±20	10	0.024	2.90	
	ELC10E4R7L	4.7			0.027	2.80	
	ELC10E5R6L	5.6			0.030	2.70	
	ELC10E6R8L	6.8			0.032	2.60	
	ELC10E8R2L	8.2			0.035	2.50	
	ELC10E100L	10.0			0.038	2.40	
	ELC10E120L	12.0			0.040	2.30	
	ELC10E150L	15.0			0.046	2.20	
	ELC10E180L	18.0			0.049	2.10	
	ELC10E220L	22.0			0.056	2.00	
	Recommended PWB piercing plan 	ELC10E270L	27.0		±15	0.062	1.90
		ELC10E330L	33.0			0.068	1.80
		ELC10E390L	39.0			0.074	1.70
		ELC10E470L	47.0			0.098	1.50
		ELC10E560L	56.0			0.120	1.30
		ELC10E680L	68.0			0.150	1.20
		ELC10E820L	82.0			0.190	1.00
		ELC10E101L	100.0			0.210	0.96
		ELC10E121L	120.0			0.240	0.92
		ELC10E151L	150.0			0.260	0.83
Connection Schematic 	ELC10E181L	180.0	±10	0.290	0.74		
	ELC10E221L	220.0		0.410	0.64		
	ELC10E271L	270.0		0.590	0.54		
	ELC10E331L	330.0		0.660	0.52		
	ELC10E391L	390.0		0.720	0.50		
	ELC10E471L	470.0		0.800	0.45		
	ELC10E561L	560.0		1.100	0.41		
	ELC10E681L	680.0		1.200	0.37		
	ELC10E821L	820.0		1.600	0.33		
	ELC10E102L	1000.0		1.800	0.31		
ELC10E122L	1200.0	2.000	0.29				
ELC10E152L	1500.0	2.800	0.26				
ELC10E182L	1800.0	3.200	0.23				
ELC10E222L	2200.0	3.600	0.20				
ELC10E272L	2700.0	5.200	0.18				
ELC10E332L	3300.0	5.900	0.17				
ELC10E392L	3900.0	6.500	0.16				
ELC10E472L	4700.0	9.600	0.14				
ELC10E562L	5600.0	10.800	0.12				
ELC10E682L	6800.0	11.900	0.11				
ELC10E822L	8200.0	13.200	0.10				

* Allowable DC Current: Smaller current value either when the inductance is -10 % or when the case temperature has risen 45 °C.

Examples Type 12E-L

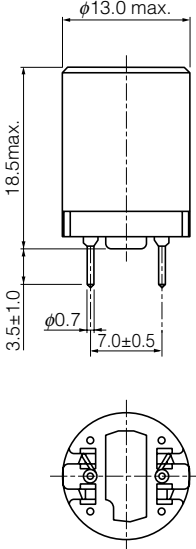
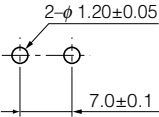
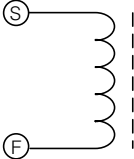
	Part No.	Inductance (μH)	Tolerance (%)	Test Freq. (kHz)	R _{DC} (Ω) [at 20 °C] (Tol.±20 %)	*I _{DC} . [at 20 °C] (A)max.
<p>[Dimensions in mm] (not to scale)</p>  <p>Recommended PWB piercing plan</p>  <p>Connection Schematic</p> 	ELC12E4R7L	4.7	±25	10	0.014	4.40
	ELC12E5R6L	5.6			0.016	4.10
	ELC12E6R8L	6.8			0.018	3.90
	ELC12E8R2L	8.2	±20		0.020	3.70
	ELC12E100L	10.0			0.023	3.50
	ELC12E120L	12.0			0.024	3.30
	ELC12E150L	15.0			0.028	3.20
	ELC12E180L	18.0			0.030	3.10
	ELC12E220L	22.0			±10	0.033
	ELC12E270L	27.0	0.037			2.50
	ELC12E330L	33.0	0.041			2.40
	ELC12E390L	39.0	0.044			2.20
	ELC12E470L	47.0	0.048			2.00
	ELC12E560L	56.0	0.053			1.80
	ELC12E680L	68.0	0.073			1.70
	ELC12E820L	82.0	0.098			1.40
	ELC12E101L	100.0	0.140			1.30
	ELC12E121L	120.0	0.160			1.20
	ELC12E151L	150.0	0.180			1.10
	ELC12E181L	180.0	0.200			1.00
	ELC12E221L	220.0	0.220		0.91	
	ELC12E271L	270.0	0.320		0.83	
	ELC12E331L	330.0	0.360		0.79	
	ELC12E391L	390.0	0.400		0.70	
	ELC12E471L	470.0	0.440		0.64	
	ELC12E561L	560.0	0.490		0.57	
	ELC12E681L	680.0	0.610		0.52	
	ELC12E821L	820.0	0.760		0.47	
	ELC12E102L	1000.0	1.100		0.43	
	ELC12E122L	1200.0	1.200		0.40	
	ELC12E152L	1500.0	1.400		0.36	
	ELC12E182L	1800.0	1.900		0.32	
	ELC12E222L	2200.0	2.500		0.30	
ELC12E272L	2700.0	3.500	0.26			
ELC12E332L	3300.0	3.900	0.24			
ELC12E392L	3900.0	4.300	0.22			
ELC12E472L	4700.0	6.000	0.20			
ELC12E562L	5600.0	6.600	0.17			
ELC12E682L	6800.0	9.900	0.15			
ELC12E822L	8200.0	10.900	0.14			
ELC12E103L	10000.0	12.200	0.13			

* Allowable DC Current: Smaller current value either when the inductance is -10 % or when the case temperature has risen 45 °C.

Examples Type 15E-L

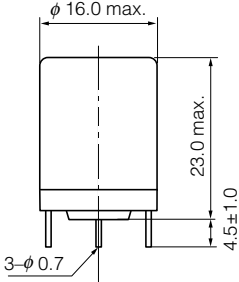
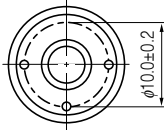
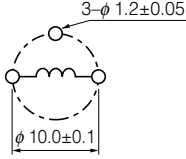
	Part No.	Inductance (μH)	Tolerance (%)	Test Freq. (kHz)	R _{DC} (Ω) [at 20 °C] (Tol.±20 %)	*I _{DC} [at 20 °C] (A)max.
<p>[Dimensions in mm] (not to scale)</p>   <p>Recommended PWB piercing plan</p> 	ELC15E5R6L	5.6	±20	10	0.012	6.80
	ELC15E6R8L	6.8			0.013	6.30
	ELC15E8R2L	8.2			0.016	5.80
	ELC15E100L	10			0.018	5.40
	ELC15E120L	12			0.019	5.10
	ELC15E150L	15			0.022	4.70
	ELC15E180L	18			0.024	4.50
	ELC15E220L	22			0.027	4.30
	ELC15E270L	27			0.029	4.10
	ELC15E330L	33			0.032	4.00
	ELC15E390L	39			0.033	3.80
	ELC15E470L	47			0.037	3.70
	ELC15E560L	56			0.039	3.60
	ELC15E680L	68			0.045	3.50
	ELC15E820L	82			0.048	3.20
	ELC15E101L	100	0.053		3.00	
	ELC15E121L	120	0.059		2.60	
	ELC15E151L	150	0.077		2.40	
	ELC15E181L	180	0.100		2.30	
	ELC15E221L	220	0.140		2.00	
	ELC15E271L	270	0.150		1.70	
	ELC15E331L	330	0.170		1.60	
	ELC15E391L	390	0.190		1.50	
	ELC15E471L	470	0.210		1.30	
	ELC15E561L	560	0.280		1.20	
	ELC15E681L	680	0.310		1.10	
	ELC15E821L	820	0.440		1.00	
	ELC15E102L	1000	0.490		0.95	
	ELC15E122L	1200	0.540		0.85	
	ELC15E152L	1500	0.710		0.80	
	ELC15E182L	1800	0.870		0.75	
	ELC15E222L	2200	1.100		0.63	
	ELC15E272L	2700	1.400		0.60	
ELC15E332L	3300	1.600	0.53			
ELC15E392L	3900	1.700	0.47			
ELC15E472L	4700	2.400	0.43			
ELC15E562L	5600	2.600	0.39			
ELC15E682L	6800	2.900	0.36			
ELC15E822L	8200	3.500	0.34			
ELC15E103L	10000	4.600	0.30			

* Allowable DC Current: Smaller current value either when the inductance is -10 % or when the case temperature has risen 45 °C.

Examples Type 18E-L

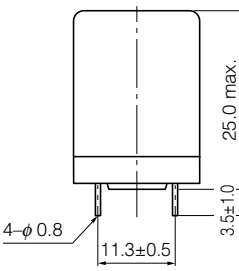
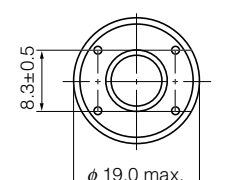
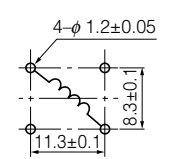
	Part No.	Inductance (μH)	Tolerance (%)	Test Freq. (kHz)	R _{DC} (Ω) [at 20 °C] (Tol.±20 %)	*I _{DC} . [at 20 °C] (A)max.
<p>[Dimensions in mm] (not to scale)</p>   <p>Recommended PWB piercing plan</p>  <p>(Top View)</p>	ELC18E5R6L	5.6	±20	10	0.011	6.70
	ELC18E6R8L	6.8			0.013	6.50
	ELC18E8R2L	8.2			0.013	6.20
	ELC18E100L	10			0.014	5.90
	ELC18E120L	12			0.016	5.60
	ELC18E150L	15			0.017	5.40
	ELC18E180L	18			0.019	5.20
	ELC18E220L	22			0.022	5.00
	ELC18E270L	27			0.023	4.80
	ELC18E330L	33			0.026	4.60
	ELC18E390L	39			0.028	4.50
	ELC18E470L	47			0.030	4.10
	ELC18E560L	56			0.031	3.80
	ELC18E680L	68			0.036	3.60
	ELC18E820L	82			0.040	3.50
	ELC18E101L	100			0.044	3.00
	ELC18E121L	120			0.047	2.80
	ELC18E151L	150	0.061		2.60	
	ELC18E181L	180	0.067		2.50	
	ELC18E221L	220	0.076		2.10	
	ELC18E271L	270	0.083		2.00	
	ELC18E331L	330	0.110		1.90	
	ELC18E391L	390	0.120		1.80	
	ELC18E471L	470	0.150		1.50	
	ELC18E561L	560	0.170		1.40	
	ELC18E681L	680	0.190		1.20	
	ELC18E821L	820	0.210		1.10	
	ELC18E102L	1000	0.280		1.00	
	ELC18E122L	1200	0.360		0.95	
	ELC18E152L	1500	0.510		0.90	
	ELC18E182L	1800	0.570		0.80	
	ELC18E222L	2200	0.630		0.73	
	ELC18E272L	2700	0.890		0.65	
	ELC18E332L	3300	1.000		0.60	
ELC18E392L	3900	1.100	0.50			
ELC18E472L	4700	1.400	0.48			
ELC18E562L	5600	1.600	0.46			
ELC18E682L	6800	2.200	0.39			
ELC18E822L	8200	2.400	0.35			
ELC18E103L	10000	2.700	0.33			
			±10			

* Allowable DC Current: Smaller current value either when the inductance is -10 % or when the case temperature has risen 45 °C.

■ Tape Dimensions in mm for Type 09D (not to scale)

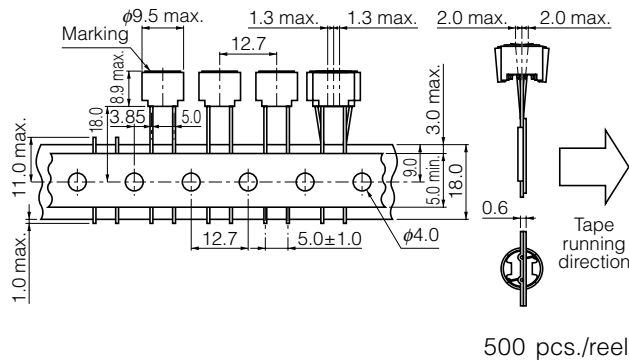

■ Tape Dimensions in mm for Type 11D (not to scale)

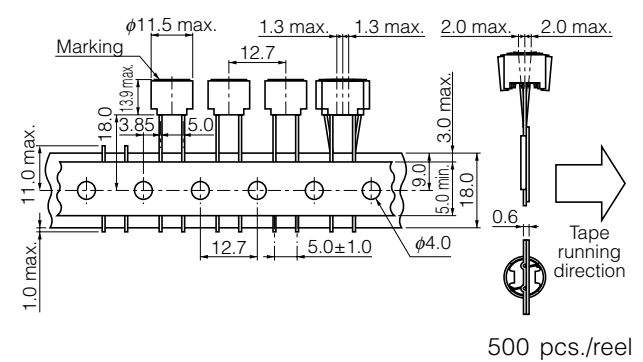

⚠ Safety Precautions

- When using our products, no matter what sort of equipment they might be used for, be sure to make a written agreement on the specifications with us in advance. The design and specifications in this catalog are subject to change without prior notice.
- Do not use the products beyond the specifications described in this catalog.
- This catalog explains the quality and performance of the products as individual components. Before use, check and evaluate their operations when installed in your products.
- Install the following systems for a failsafe design to ensure safety if these products are to be used in equipment where a defect in these products may cause the loss of human life or other significant damage, such as damage to vehicles (automobile, train, vessel), traffic lights, medical equipment, aerospace equipment, electric heating appliances, combustion/gas equipment, rotating equipment, and disaster/crime prevention equipment.
- * Systems equipped with a protection circuit and a protection device
- * Systems equipped with a redundant circuit or other system to prevent an unsafe status in the event of a single fault

⚠ Precautions for use

1. Rated current

The rated current is defined as the smaller value of either the current value when the inductance drops 10 % down from its initial point, or when the average temperature of coil interior rises 45 °C up on power source. Do not operate these coils beyond the specified rated current.

2. Mounting

- ① Cores may be damaged when excessive force or shock is applied.
Do not use products which may have been dropped.
- ② Be careful not to make contact with other parts and consider possible interaction between coils due to magnetic interference.
- ③ Be careful of being too close to heat-radiating parts (high temperature).
- ④ Do not bend the pin-terminals during assembly.
The pin-terminals must connect correctly.
Do not subject them to shock to avoid causing an open or short circuit condition.
- ⑤ The float on PWB must not be after mounting.

3. Soldering

- ① Use flux which will not effect copper wire. (Be sure to use proper amounts of chloride, pH and other solvents)
- ② When using a soldering iron, wait at least 3 minutes before attempting to re-solder.

4. Storage

- ① Avoid high temperatures, high moisture, gases and magnetic fields.
- ② For long term storage of more than 1 year, use the products only after inspecting their outer structure.
(Look for possible rusting of the core and oxidation of the lead wire, which would affect its solderability.)

<Package markings>

Package markings include the product number, quantity, and country of origin. In principle, the country of origin should be indicated in English.

CAUTION AND WARNING

1. The electronic components contained in this catalog are designed and produced for use in home electric appliances, office equipment, information equipment, communications equipment, and other general purpose electronic devices.
Before use of any of these components for equipment that requires a high degree of safety, such as medical instruments, aerospace equipment, disaster-prevention equipment, security equipment, vehicles (automobile, train, vessel), please be sure to contact our sales representative.
2. When applying one of these components for equipment requiring a high degree of safety, no matter what sort of application it might be, be sure to install a protective circuit or redundancy arrangement to enhance the safety of your equipment. In addition, please carry out the safety test on your own responsibility.
3. When using our products, no matter what sort of equipment they might be used for, be sure to make a written agreement on the specifications with us in advance.
4. Technical information contained in this catalog is intended to convey examples of typical performances and/or applications and is not intended to make any warranty with respect to the intellectual property rights or any other related rights of our company or any third parties nor grant any license under such rights.
5. In order to export products in this catalog, the exporter may be subject to the export license requirement under the Foreign Exchange and Foreign Trade Law of Japan.
6. No ozone-depleting substances (ODSs) under the Montreal Protocol are used in the manufacturing processes of Automotive & Industrial Systems Company, Panasonic Corporation.

● Please contact

● Factory

Circuit Components Business Division
Automotive & Industrial Systems Company
Panasonic Corporation
401 Sadamasa-cho, Fukui-shi,
Fukui 910-8502, JAPAN

The information in this catalog is valid as of October 2013.