

RoHS compliant

FEATURES

- **Smallest in its class, it is extremely compact at approx. 2/3 the size of previous products.**

Compared to our previous miniature type CT relay, both the 1 Form C and 10-pin and 8-pin twin types take up approx. two-thirds the space and volume. This makes them ideal for relay unit miniaturization.

- **Compact and high-capacity 25 A load switching**

High capacity control is possible while being compact and capable of motor lock load switching at 25 A, 14 V DC.

- **Pin in Paste* compatible model added**

Models compatible with the recently increasing Pin in Paste technique (reflow solder mounting) have been added.

Pin in Paste compatible models are the flux tight type.

* The Pin in Paste method may sometimes be referred to as THR (Through-hole Reflow).

- **Environmental protection specifications**

Cadmium-free contacts and use of lead-free solder are standard. Environmental pollutants are not used.

TYPICAL APPLICATIONS

- **Powered windows**
- **Automatic door locks**
- **Electrically powered mirrors**
- **Powered sunroofs**
- **Powered seats**
- **Lift gates**
- **Smart J/B related products, etc.**

TYPES

Contact arrangement	Nominal coil voltage	Pick-up voltage (at 20°C 68°F)	Part No.	
			Standard type	Pin in Paste type
1 Form C	12 V DC	Max.6.5 V DC (Initial)	ACJ1112	ACJ1112P
		Max.7.2 V DC (Initial)	ACJ1212	ACJ1212P
1 Form C × 2 (8 terminal)		Max.6.5 V DC (Initial)	ACJ2112	ACJ2112P
		Max.7.2 V DC (Initial)	ACJ2212	ACJ2212P
1 Form C × 2 (10 terminal)		Max.6.5 V DC (Initial)	ACJ5112	ACJ5112P
		Max.7.2 V DC (Initial)	ACJ5212	ACJ5212P

Standard packing; Carton (tube): 70 pcs.; Case: 2,800 pcs. (1 Form C), Carton (tube): 40 pcs.; Case: 1,000 pcs. (8 terminal),
Carton (tube): 35 pcs.; Case: 1,400 pcs. (10 terminal)

RATING

1. Coil data

Nominal coil voltage	Pick-up voltage (at 20°C 68°F)	Drop-out voltage (at 20°C 68°F)	Nominal operating current [±10%] (at 20°C 68°F)	Coil resistance [±10%] (at 20°C 68°F)	Nominal operating power (at 20°C 68°F)	Usable voltage range*
12 V DC	Max. 7.2 V DC (Initial)	Min. 1.0 V DC (Initial)	53.3 mA	225Ω	640 mW	10 to 16 V DC
	Max. 6.5 V DC (Initial)	Min. 0.8 V DC (Initial)	66.7 mA	180Ω	800 mW	9 to 16 V DC

* Other usable voltage range types are also available. Please contact us for details.

2. Specifications

Characteristics	Item	Specifications	
Contact	Arrangement	1 Form C, 1 Form C×2	
	Contact resistance (Initial)	N.O.: Typ7mΩ, N.C.: Typ10mΩ (By voltage drop 6 V DC 1 A)	
	Contact material	Ag alloy (Cadmium free)	
Protective construction		Standard type: Sealed type Pin in Paste type: Flux tight type	
Rating	Nominal switching capacity (resistive load)	N.O.: 20A 14V DC, N.C.: 10A 14V DC	
	Max. carrying current (14V DC)	N.O.: 20 A for 1 hour, 30 A for 2 minutes (at 20°C 68°F) (when coil powered on one side)	
	Nominal operating power	640 mW (for pick-up voltage max. 7.2 V DC), 800 mW (for pick-up voltage max. 6.5 V DC)	
	Min. switching capacity (resistive load)*1	1A 12V DC	
Electrical characteristics	Initial insulation resistance		Min. 100 MΩ (at 500 V DC)
	Breakdown voltage (Initial)	Between open contacts	500 Vrms for 1 min. (Detection current: 10mA)
		Between contacts and coil	500 Vrms for 1 min. (Detection current: 10mA)
	Operate time (at nominal voltage)		Max. 10ms (at 20°C 68°F, excluding contact bounce time) (Initial)
	Release time (at nominal voltage)		Max. 10ms (at 20°C 68°F, excluding contact bounce time) (Initial)
Mechanical characteristics	Shock resistance	Functional	Min. 100 m/s ² {10G} (Half-wave pulse of sine wave: 11ms; detection time: 10μs)
		Destructive	Min. 1,000 m/s ² {100G} (Half-wave pulse of sine wave: 6ms)
	Vibration resistance	Functional	10 Hz to 100 Hz, Min. 44.1m/s ² {4.5G} (Detection time: 10μs)
		Destructive	10 Hz to 500 Hz, Min. 44.1m/s ² {4.5G} Time of vibration for each direction; X, Y direction: 2 hours, Z direction: 4 hours
Expected life	Mechanical	Min. 10 ⁷ (at 120 cpm)	
	Electrical	[Standard type] <Resistive load> Min. 10 ⁵ (at nominal switching capacity, operating frequency: 1s ON, 9s OFF) <Motor load> N.O. side: Min. 2×10 ⁵ : at 25 A (inrush), 5 A (steady), 14 V DC; Min. 10 ⁵ : at 25 A 14 V DC (Motor lock) N.C. side: Min. 2×10 ⁵ : at 20 A 14 V DC (brake) (Operating frequency: 0.5s ON, 9.5s OFF) [Pin in Paste type] <Resistive load> Min. 10 ⁵ (at nominal switching capacity, operating frequency: 1s ON, 9s OFF) <Motor load> N.O. side: Min. 10 ⁵ : at 25 A (inrush), 5 A (steady), 14 V DC; Min. 5×10 ⁴ : at 25 A 14 V DC (Motor lock) N.C. side: Min. 10 ⁵ : at 20 A 14 V DC (brake) (Operating frequency: 0.5s ON, 9.5s OFF)	
Conditions	Conditions for operation, transport and storage*2	Ambient temperature: -40°C to +85°C -40°F to +185°F Humidity: 5% R.H. to 85% R.H. (Not freezing and condensing at low temperature)	
	Max. operating speed	6 cpm (at nominal switching capacity)	
Mass		1 Form C type: approx. 3.5 g .12 oz, Twin type: approx. 6.5 g .23 oz	

Notes: *1. This value can change due to the switching frequency, environmental conditions, and desired reliability level, therefore it is recommended to check this with the actual load.

*2. The upper operation ambient temperature limit is the maximum temperature that can satisfy the coil temperature rise value. Please refer to "Usage ambient condition" in CAUTIONS FOR USE OF AUTOMOTIVE RELAYS.

Please inquire if you will be using the relay in a high temperature atmosphere (110°C 230°F).

*3. Depends on connection conditions. Also, this does not guarantee repeated switching. We recommend that you confirm operation under actual conditions.

* If the relay is used continuously for long periods of time with coils on both sides in an energized condition, breakdown might occur due to abnormal heating depending on the carrying condition. Therefore, please inquire when using with a circuit that causes an energized condition on both sides simultaneously.

REFERENCE DATA

1-(1). Coil temperature rise (at room temperature)

Sample: ACJ1212, 3pcs
Measured portion: Inside the coil
Contact carrying current: 10A, 15A, 20A
Ambient temperature: 25°C 77°F

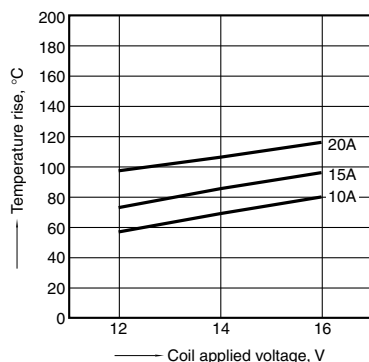

1-(2). Coil temperature rise (at 85°C 185°F)

Sample: ACJ1212, 3pcs
Measured portion: Inside the coil
Contact carrying current: 10A, 15A, 20A
Ambient temperature: 85°C 185°F

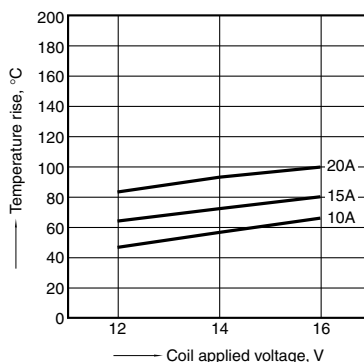

1-(3). Coil temperature rise (at room temperature)

Sample: ACJ2212, 3pcs
Measured portion: Inside the coil
Contact carrying current: 10A, 15A, 20A
Ambient temperature: 25°C 77°F

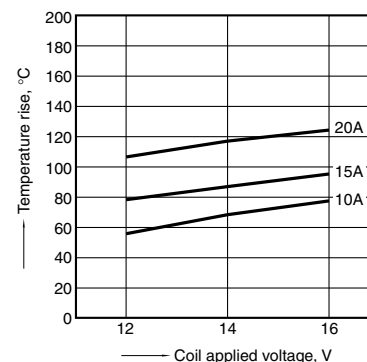

CJ (ACJ)

1-(4). Coil temperature rise (at 85°C 185°F)

Sample: ACJ2212, 3pcs
 Measured portion: Inside the coil
 Contact carrying current: 10A, 15A, 20A
 Ambient temperature: 85°C 185°F

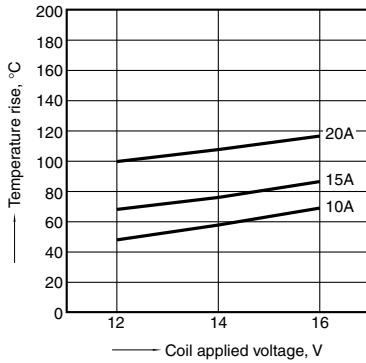

1-(5). Coil temperature rise (at room temperature)

Sample: ACJ5212, 3pcs
 Measured portion: Inside the coil
 Contact carrying current: 10A, 15A, 20A
 Ambient temperature: 25°C 77°F

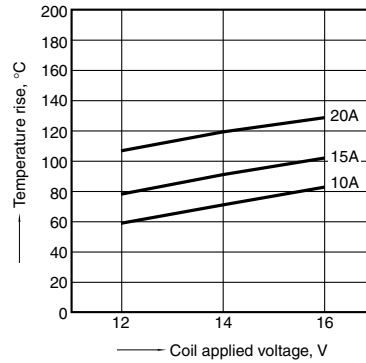

1-(6). Coil temperature rise (at 85°C 185°F)

Sample: ACJ5212, 3pcs
 Measured portion: Inside the coil
 Contact carrying current: 10A, 15A, 20A
 Ambient temperature: 85°C 185°F

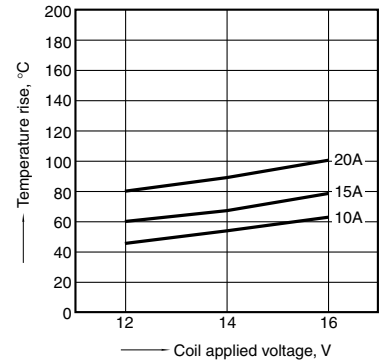

2-(1). Electrical life test (Motor free)

Sample: ACJ2212, 3pcs
 Load: Inrush current: 25A/Steady current: 5A,
 Power window motor actual load (free condition)
 Tested voltage: 14V DC
 Switching frequency: ON 0.5s, OFF 9.5s
 Switching cycle: 2×10⁵
 Ambient temperature: Room temperature
 Circuit

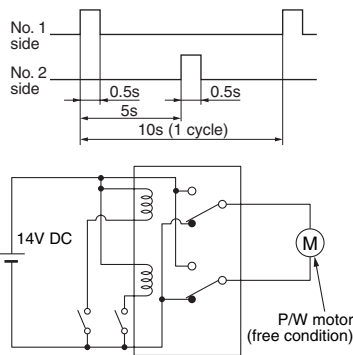

Change of pick-up and drop-out voltage

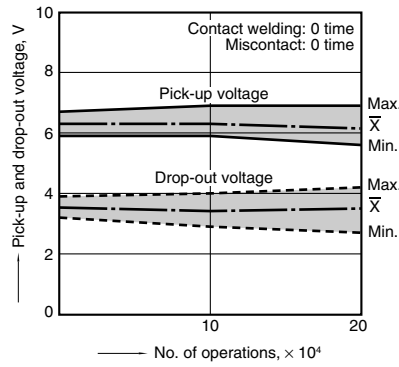

Change of contact resistance

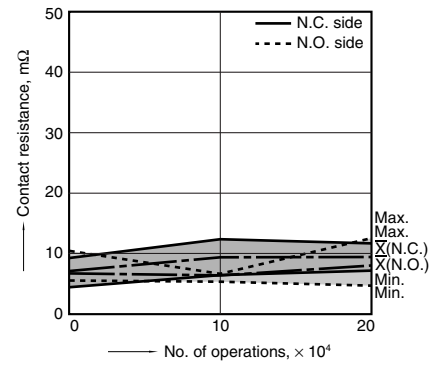

Load current waveform

Inrush current: 25A, Steady current: 6A,
 Brake current: 13A

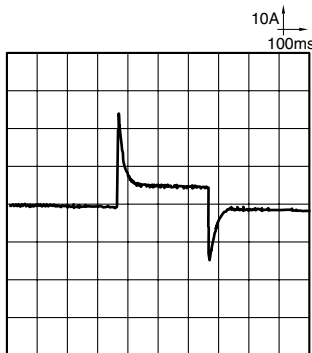

2-(2). Electrical life test (Motor lock)

Sample: ACJ2212, 3pcs
 Load: Steady current: 25A, Power window motor actual load (lock condition)
 Tested voltage: 14V DC
 Switching frequency: ON 0.5s, OFF 9.5s
 Switching cycle: 10⁵
 Ambient temperature: Room temperature
 Circuit

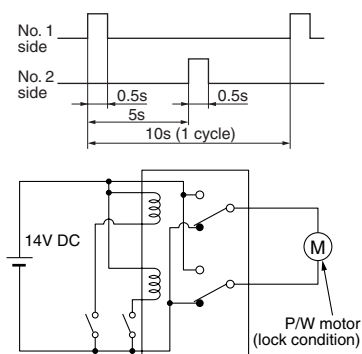

Load current waveform
 Current value: 25A

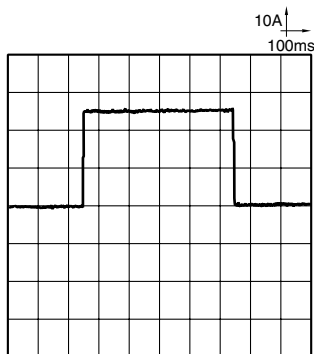

Change of pick-up and drop-out voltage

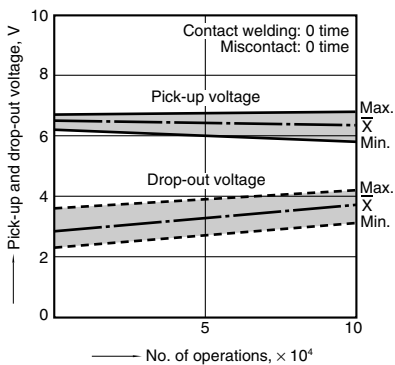

Change of contact resistance

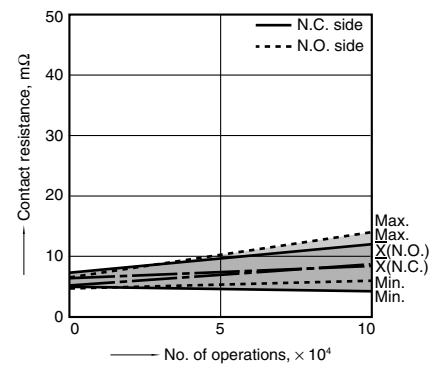

DIMENSIONS (mm inch)

The CAD data of the products with a **CAD Data** mark can be downloaded from: <http://industrial.panasonic.com/ac/e>

1. Twin type (8-pin)

CAD Data



External dimensions

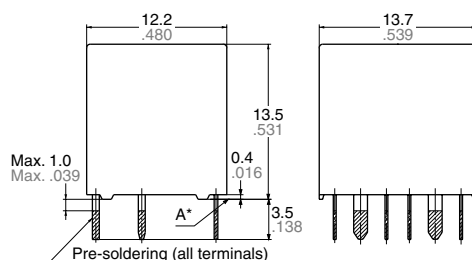

PC board pattern (Bottom view)

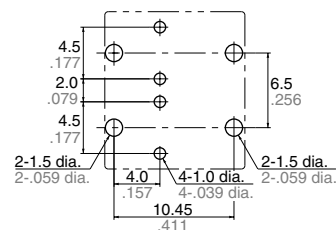

Tolerance: $\pm 0.1 \pm .004$

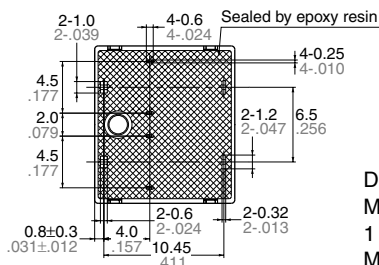

Dimension:
 Max. 1mm .039 inch: $\pm 0.1 \pm .004$
 1 to 3mm .039 to .118 inch: $\pm 0.2 \pm .008$
 Min. 3mm .118 inch: $\pm 0.3 \pm .012$

Schematic (Bottom view)

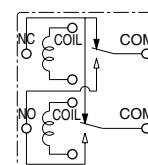

* Dimensions (thickness and width) of terminal is measured before pre-soldering.
 Intervals between terminals is measured at A surface level.

CJ (ACJ)

2. Twin type (8-pin) Pin in Paste type

CAD Data



External dimensions

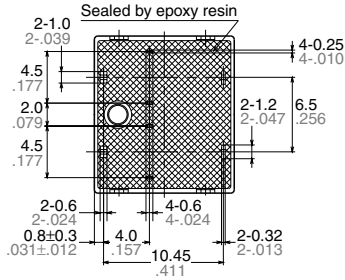
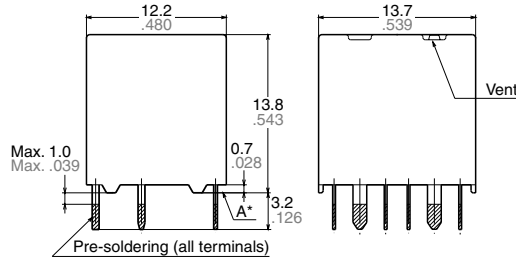

Dimension:	Tolerance
Max. 1mm .039 inch:	$\pm 0.1 \pm 0.004$
1 to 3mm .039 to .118 inch:	$\pm 0.2 \pm 0.008$
Min. 3mm .118 inch:	$\pm 0.3 \pm 0.012$

PC board pattern (Bottom view)

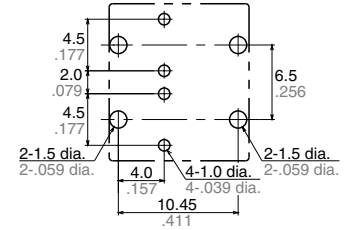

Tolerance: $\pm 0.1 \pm 0.004$

Schematic (Bottom view)

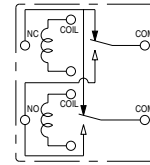

* Dimensions (thickness and width) of terminal is measured before pre-soldering.
Intervals between terminals is measured at A surface level.

3. Twin type (10-pin) Standard type

CAD Data



External dimensions

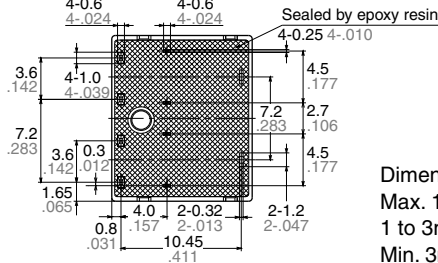
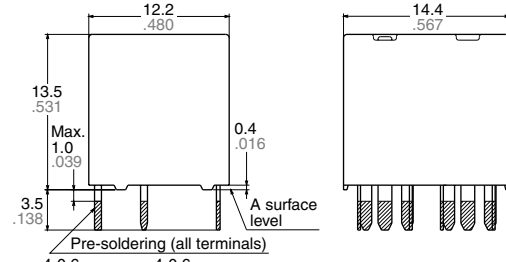

Dimension:	Tolerance
Max. 1mm .039 inch:	$\pm 0.1 \pm 0.004$
1 to 3mm .039 to .118 inch:	$\pm 0.2 \pm 0.008$
Min. 3mm .118 inch:	$\pm 0.3 \pm 0.012$

PC board pattern (Bottom view)

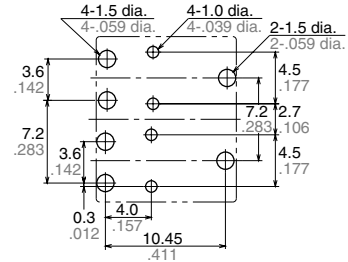

Tolerance: $\pm 0.1 \pm 0.004$

Schematic (Bottom view)

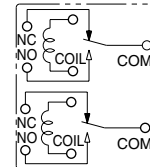

4. Twin type (10-pin) Pin in Paste type

CAD Data



External dimensions

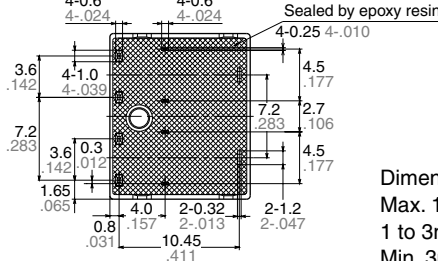
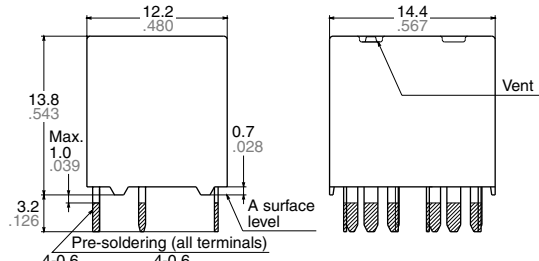

Dimension:	Tolerance
Max. 1mm .039 inch:	$\pm 0.1 \pm 0.004$
1 to 3mm .039 to .118 inch:	$\pm 0.2 \pm 0.008$
Min. 3mm .118 inch:	$\pm 0.3 \pm 0.012$

PC board pattern (Bottom view)

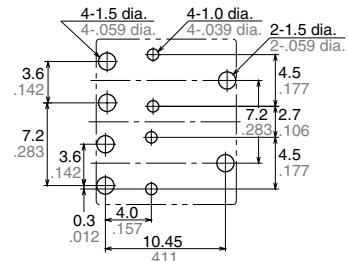

Tolerance: $\pm 0.1 \pm 0.004$

Schematic (Bottom view)

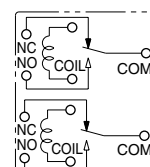

5. Slim 1 Form C Standard type

CAD Data



External dimensions

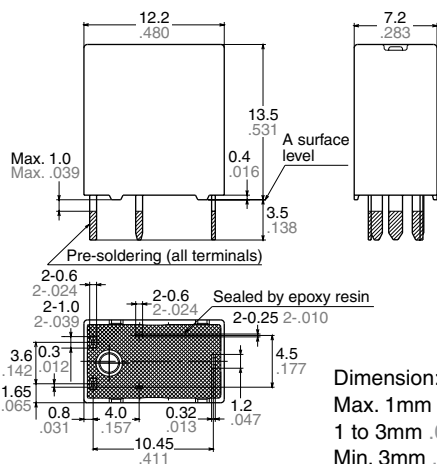

Dimension:
 Max. 1mm .039 inch: $\pm 0.1 \pm .004$
 1 to 3mm .039 to .118 inch: $\pm 0.2 \pm .008$
 Min. 3mm .118 inch: $\pm 0.3 \pm .012$

PC board pattern (Bottom view)

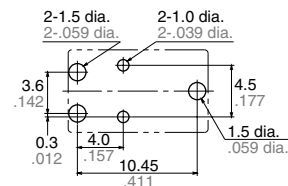

Tolerance: $\pm 0.1 \pm .004$

Schematic (Bottom view)

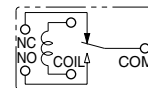

6. Slim 1 Form C Pin in Paste type

CAD Data



External dimensions

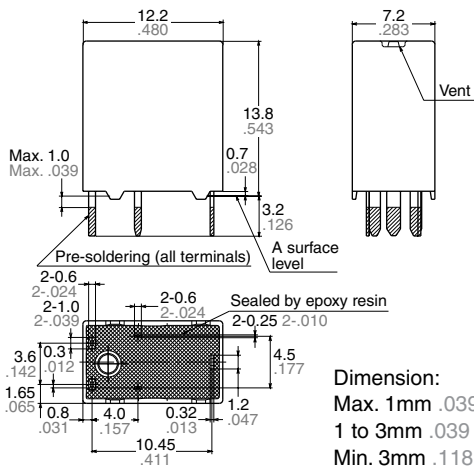

Dimension:
 Max. 1mm .039 inch: $\pm 0.1 \pm .004$
 1 to 3mm .039 to .118 inch: $\pm 0.2 \pm .008$
 Min. 3mm .118 inch: $\pm 0.3 \pm .012$

PC board pattern (Bottom view)

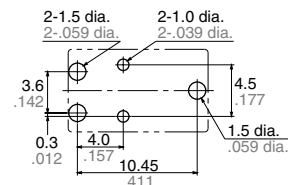

Tolerance: $\pm 0.1 \pm .004$

Schematic (Bottom view)

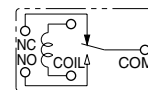

For Cautions for Use.