

Panasonic
ideas for life

1a 3A slim power relays

LD RELAYS (ALD)



RoHS compliant

FEATURES

- 1. Slim type: Width 7 mm .276 inch.**
20.3(L)×7.0(W)×15.0(H) mm
.799(L)×.276(W)×.591(H) inch
- 2. Perfect for small load switching of home appliances**
10⁵ switching operations possible with a 3A 250V AC resistive load.
- 3. Low operating power**
Compact size, nominal operating power as low as 200mW.
- 4. High shock resistance**
The relay withstands a functional shock resistance of 300m/s² [approx. 30 G more]

- 5. High insulation resistance**
 - Creepage distance and clearances between contact and coil: Min. 6 mm .236 inch
 - Surge withstand voltage between contact and coil: 10,000 V
- 6. UL, CSA, VDE, TÜV approved.**

TYPICAL APPLICATIONS

- Air conditioner
- Refrigerator
- Hot water units
- Microwave ovens
- Fan heaters

ORDERING INFORMATION

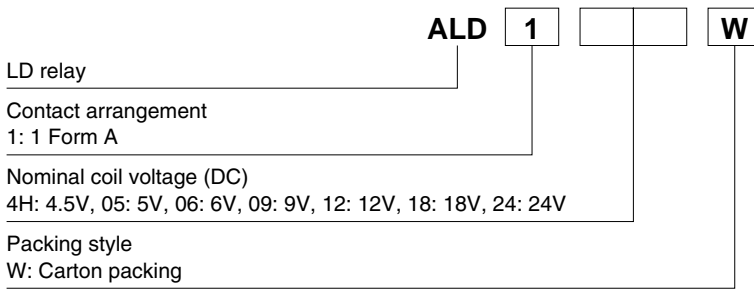

Note: Certified by UL, CSA, TÜV and VDE

TYPES

Contact arrangement	Nominal coil voltage	Part No.
1 Form A	4.5V DC	ALD14HW
	5V DC	ALD105W
	6V DC	ALD106W
	9V DC	ALD109W
	12V DC	ALD112W
	18V DC	ALD118W
	24V DC	ALD124W

Packing quantity: Carton 100 pieces, Case 500 pieces

Note: The "W" at the end of the part number only appears on the inner and outer packaging. It does not appear on the relay itself. Please consult with our sales office on a tube packing type.

RATING

1. Coil data

Nominal coil voltage	Pick-up voltage (at 20°C 68°F)	Drop-out voltage (at 20°C 68°F)	Nominal operating current [±10%] (at 20°C 68°F)	Coil resistance [±10%] (at 20°C 68°F)	Nominal operating power	Max. applied voltage (at 20°C 68°F)
4.5V DC	75%V or less of nominal voltage (Initial)	5%V or more of nominal voltage (Initial)	44.6mA	101Ω	200mW	130%V of nominal voltage
5V DC			40.0mA	125Ω		
6V DC			33.3mA	180Ω		
9V DC			22.2mA	405Ω		
12V DC			16.7mA	720Ω		
18V DC			11.1mA	1,620Ω		
24V DC			8.3mA	2,880Ω		

2. Specifications

Characteristics	Item	Specification	
Contact	Arrangement	1 Form A	
	Contact resistance (Initial)	Max. 100 mΩ (By voltage drop 6 V DC 1A)	
	Contact material	AgNi type	
Rating	Nominal switching capacity (resistive load)	3A 277V AC, 3A 30V DC	
	Max. switching power (resistive load)	831VA (AC), 90W (DC)	
	Max. switching voltage	277V AC, 30V DC	
	Max. switching current	3A	
	Min. switching capacity*1	100mA, 5V DC	
Electrical characteristics	Insulation resistance (Initial)	Min. 1,000MΩ (at 500V DC) Measurement at same location as "Breakdown voltage" section.	
	Breakdown voltage (Initial)	Between open contacts	750 Vrms for 1 min. (Detection current: 10 mA)
		Between contact and coil	4,000 Vrms for 1 min. (Detection current: 10 mA)
	Temperature rise (coil)	Max. 45°C 113°F (By resistive method, nominal coil voltage applied to the coil; contact carrying current: 3A, at 70°C 158°F)	
	Surge breakdown voltage*2 (Between contact and coil) (Initial)	10,000 V	
	Operate time (at nominal voltage) (at 20°C 68°F)	Max. 10 ms (excluding contact bounce time.)	
Release time (at nominal voltage) (at 20°C 68°F)	Max. 10 ms (excluding contact bounce time) (With diode)		
Mechanical characteristics	Shock resistance	Functional	300 m/s ² (Half-wave pulse of sine wave: 11 ms; detection time: 10μs.)
		Destructive	1,000 m/s ² (Half-wave pulse of sine wave: 6 ms.)
	Vibration resistance	Functional	10 to 55 Hz at double amplitude of 1.5 mm (Detection time: 10μs.)
		Destructive	10 to 55 Hz at double amplitude of 1.5 mm
Expected life	Mechanical (at 180 times/min.)	Min. 5×10 ⁶	
	Electrical (at 20 times/min.)	Min. 2×10 ⁵ (3A 125V AC, 3A 30V DC at rated load), Min. 10 ⁵ (3A 250V AC at rated load)	
Conditions	Conditions for operation, transport and storage*3	Ambient temperature: -40°C to +70°C -40°F to +158°F, Humidity: 5 to 85% R.H. (Not freezing and condensing at low temperature)	
	Max. operating speed	20 times/min. (at nominal switching capacity)	
Unit weight		Approx. 4 g .14 oz	

Notes: *1. This value can change due to the switching frequency, environmental conditions, and desired reliability level, therefore it is recommended to check this with the actual load.

*2. Wave is standard shock voltage of ±1.2×50μs according to JEC-212-1981

*3. The upper limit of the ambient temperature is the maximum temperature that can satisfy the coil temperature rise value. Refer to Usage, transport and storage conditions in NOTES.

REFERENCE DATA

1. Max. switching power

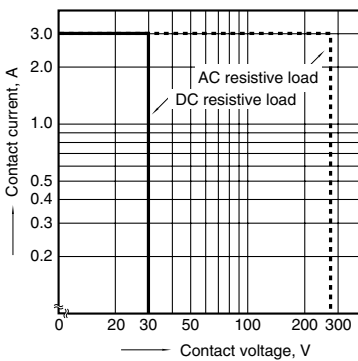

2. Life curve

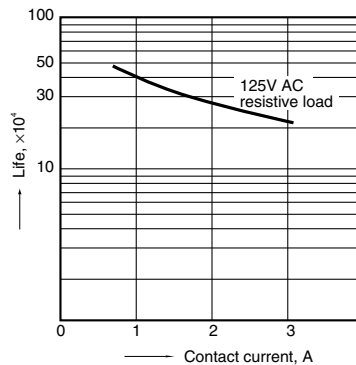

3. Coil temperature rise

Sample: ALD112W, 6 pcs.
 Point measured: inside the coil
 Contact current: 0 A, 3 A

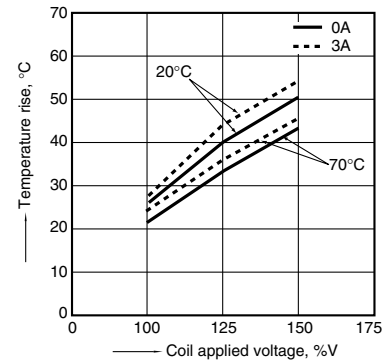

4-(1). Operate time

Sample: ALD112W, 6 pcs.

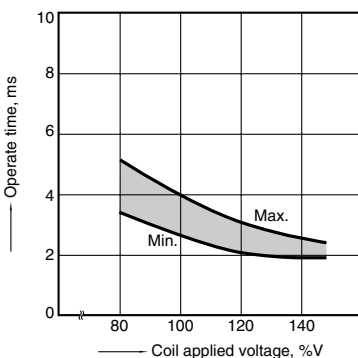

4-(2). Release time (without diode)

Sample: ALD112W, 6 pcs.

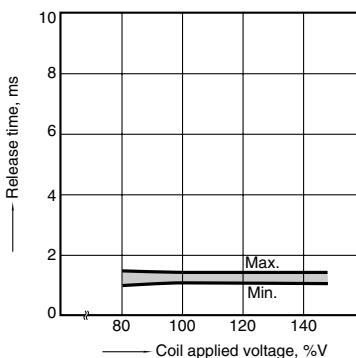

4-(3). Release time (with diode)

Sample: ALD112W, 6 pcs.

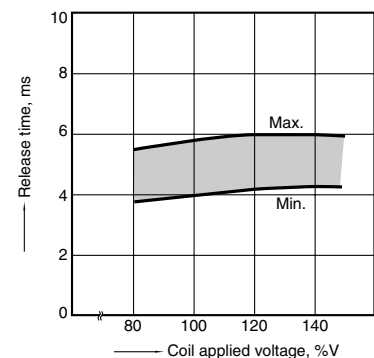

DIMENSIONS (mm inch)

The CAD data of the products with a **CAD Data** mark can be downloaded from: <http://industrial.panasonic.com/ac/e/>

CAD Data

External dimensions

PC board pattern (Bottom view)

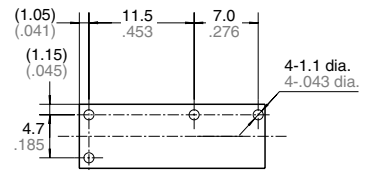
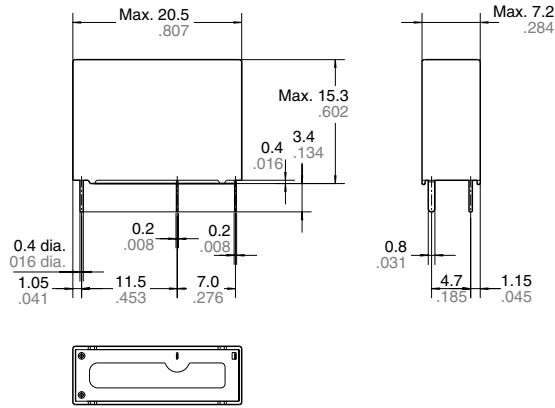

Tolerance: $\pm 0.1 \pm .004$

Schematic (Bottom view)

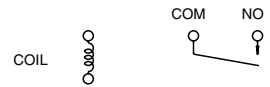

Dimension:

Less than 1mm .039inch:
 Min. 1mm .039inch less than 3mm .118 inch: $\pm 0.2 \pm .008$
 Min. 3mm .118 inch: $\pm 0.3 \pm .012$

General tolerance

$\pm 0.1 \pm .004$
 $\pm 0.2 \pm .008$
 $\pm 0.3 \pm .012$

SAFETY STANDARDS

UL/C-UL (Recognized)		CSA (Certified)		VDE (Certified)		TÜV (Certified)	
File No.	Contact rating	File No.	Contact rating	File No.	Contact rating	File No.	Rating
E43028	3A 277V AC 3A 30V DC	LR26550 etc.	3A 277V AC 3A 30V DC	40014384	3A 250V AC ($\cos\phi = 1.0$) 3A 30V DC (0ms)	B 11 03 13461 289	3A 250V AC ($\cos\phi = 1.0$) 3A 30V DC (0ms)

For Cautions for Use.